

CCC-700  
MCNP4C

# OAK RIDGE NATIONAL LABORATORY

managed by  
UT-BATTELLE, LLC  
for the  
U.S. DEPARTMENT OF ENERGY

## RSICC COMPUTER CODE COLLECTION

### MCNP4C

Monte Carlo N-Particle Transport Code System

Contributed by:

Los Alamos National Laboratory  
Los Alamos, New Mexico



**RADIATION SAFETY INFORMATION COMPUTATIONAL CENTER**

**Legal Notice:** This material was prepared as an account of Government sponsored work and describes a code system or data library which is one of a series collected by the Radiation Safety Information Computational Center (RSICC). These codes/data were developed by various Government and private organizations who contributed them to RSICC for distribution; they did not normally originate at RSICC. RSICC is informed that each code system has been tested by the contributor, and, if practical, sample problems have been run by RSICC. Neither the United States Government, nor the Department of Energy, nor UT-BATTELLE, LLC, nor any person acting on behalf of the Department of Energy or UT-BATTELLE, LLC, makes any warranty, expressed or implied, or assumes any legal liability or responsibility for the accuracy, completeness, usefulness or functioning of any information code/data and related material, or represents that its use would not infringe privately owned rights. Reference herein to any specific commercial product, process, or service by trade name, trademark, manufacturer, or otherwise, does not necessarily constitute or imply its endorsement, recommendation, or favoring by the United States Government, the Department of Energy, UT-BATTELLE, LLC, nor any person acting on behalf of the Department of Energy or UT-BATTELLE, LLC.

**Distribution Notice:** This code/data package is a part of the collections of the Radiation Safety Information Computational Center (RSICC) developed by various government and private organizations and contributed to RSICC for distribution. Any further distribution by any holder, unless otherwise specifically provided for is prohibited by the U.S. Department of Energy without the approval of RSICC, P.O. Box 2008, Oak Ridge, TN 37831-6362.

Documentation for CCC-700/MCNP4C Code Package

	<u>PAGE</u>
RSICC Computer Code Abstract .....	iii
LANL, "README.txt" (February 29, 2000) .....	Section 1
RSICC, "README.1st" (March 1, 2001) .....	Section 2
J. S. Hendricks, "MCNP4C," X-5: JSH-2000-30 (U) (February 29, 2000) .....	Section 3
J. F. Briesmeister, Ed., "MCNP - A General Monte Carlo N-Particle Transport Code, Version 4C," LA-13709-M (April 2000) .....	Section 4
H. M. Abhold, J. S. Hendricks, "MCNP Software Quality Assurance Plan," LA-13138 (April 1996) .....	Section 5
S. Frankle, "Compiling MCNP Version '4B' on VMS," LANL Memorandum (February 12, 1997) .....	Section 6
T. Goorley, Informal Note on "MCNP4B in Parallel on PC's Running Linux" (July 22, 1997) .....	Section 7

(March 2001)

## RSICC CODE PACKAGE CCC-700

### 1. NAME AND TITLE

MCNP4C: Monte Carlo N-Particle Transport Code System.

### AUXILIARY PROGRAMS

PRPR: Pre-processor for Extracting the Various Hardware Versions of MCNP and other codes.

MAKXSF: Preparer of MCNP Cross-Section Libraries.

### RELATED DATA LIBRARY

MCNP4C includes a test library of cross sections for running the sample problems. The DLC-200/MCNPDATA code package includes data for use with MCNP and is distributed with the code package for the convenience of users.

Expanding the code system (50 MB) and binary cross section libraries (360MB) under Windows requires ~410 MB of hard disk space. Unix users need more because the ASCII cross sections require 880 MB of hard disk space.

### 2. CONTRIBUTOR

Diagnostics Applications Group, Los Alamos National Laboratory, Los Alamos, New Mexico.

### 3. CODING LANGUAGE AND COMPUTERS

FORTRAN 77 or 90 and C; UNIX workstations, Intel-based PCs, Cray, and VAX.  
(C00700/ALLCP/02).

### 4. NATURE OF PROBLEM SOLVED

MCNP is a general-purpose, continuous-energy, generalized geometry, time-dependent, coupled neutron-photon-electron Monte Carlo transport code system. MCNP4C is the first major release of MCNP since version 4B (February 4, 1997). The major new features of MCNP4C include:

- \* Unresolved resonance range probability tables;
- \* Perturbation enhancements;
- \* Superimposed mesh weight window generator;
- \* Alpha eigenvalues;
- \* Macrobodies;
- \* ENDF/B-VI improvements;
- \* PC Enhancements;
- \* Electron Physics Enhancements;
- \* Parallelization enhancements;
- \* Delayed Neutrons.

In addition, there are 30 minor features/enhancements and 65 corrections. See the MCNP home page more information <http://www-xdiv.lanl.gov/XCI/PROJECTS/MCNP>. See the Electronic Notebook at <http://www-rsicc.ornl.gov/rsic.html> for information on user experiences with MCNP.

### 5. METHOD OF SOLUTION

MCNP treats an arbitrary three-dimensional configuration of materials in geometric cells bounded by first- and second-degree surfaces and some special fourth-degree surfaces. Pointwise continuous-energy cross section data are used, although multigroup data may also be used. Fixed-source adjoint calculations may be made with the multigroup data option. For neutrons, all reactions in a particular



cross-section evaluation are accounted for. Both free gas and  $S(\alpha, \beta)$  thermal treatments are used. Criticality sources as well as fixed and surface sources are available. For photons, the code takes account of incoherent and coherent scattering with and without electron binding effects, the possibility of fluorescent emission following photoelectric absorption, and absorption in pair production with local emission of annihilation radiation. A very general source and tally structure is available. The tallies have extensive statistical analysis of convergence. Rapid convergence is enabled by a wide variety of variance reduction methods. Energy ranges are 0-60 MeV for neutrons (data generally only available up to 20 MeV) and 1 keV - 1 GeV for photons and electrons.

## 6. RESTRICTIONS OR LIMITATIONS

None noted.

## 7. TYPICAL RUNNING TIME

The 29 test cases ran in ~3 minutes on a Pentium III 550 MHz in a DOS window of WindowsNT and in ~5 minutes on a Pentium II 300MHz in a DOS window of Windows98.

## 8. COMPUTER HARDWARE REQUIREMENTS

MCNP is operable on Cray computers under UNICOS, workstations or PC's running Unix or Linux, Windows-based PC's, and VAX computers under VMS. Executable files for Windows-based PC's are provided for running Pentium computers.

## 9. COMPUTER SOFTWARE REQUIREMENTS

Compilation of MCNP requires both FORTRAN77 and ANSI C standard compilers. MCNP can be compiled with g77 on PC's running Red Hat Linux. PVM is required for multiprocessing on a cluster of workstations and can be downloaded from [www.netlib.org](http://www.netlib.org). Scripts are provided for installation on both PC and Unix systems. The PC distribution includes MCNP, PRPR and MAKXSF executables which were built in a DOS window of Windows NT using the Digital Visual Fortran 6.0A and Lahey/Fujitsu Fortran 95 Release 5.50d compilers. The Lahey-compiled MCNP executables were built with MDAS=4,000,000; 8,000,000; and 32,000,000. The DVF-compiled executable was created with dynamically allocated storage. RSICC tested this release on the following systems:

1. AIX 4.3.3 (IBM 43P-260) with XL C/C++ 4.4; XL Fortran 6.1
2. Redhat Linux Version 6.1 on 450 MHz Pentium III (9 nodes) with g77
3. Sun Solaris 2.6 on UltraSparc 60 using F77 Version 5.0 and C/C++ Version 5.0
4. HP B1000 (PA-8500) under HP-UX 10.20 with FORTRAN 77 V0.20 and HP C V10.32.00
5. DEC 500 AU under Digital Unix 4.0D with DEC Fortran 5.1-8 and DEC C 5.6-075
6. SGI MIPS R10000 (225MHz) under IRIX 6.5.5 with MIPS Fortran 77 Version 7.3
7. Pentium II 300MHz in a DOS window of Windows 98 with Digital Visual Fortran Professional Edition 6.0A Fortran 90 compiler with QuickWin plots
8. Pentium II 300MHz in a DOS window of Windows 98 with Lahey/Fujitsu Fortran 95 -- LF95 Version 5.50 Fortran 90 compiler with Winteracter Starter Kit

## 10. REFERENCES

The Adobe Acrobat Reader freeware is available from <http://www.adobe.com> to read and print the electronic documentation.

### a. included documentation in electronic format on the CD in DOC/C700DOC.PDF:

LANL, "README.txt" (February 29, 2000).

RSICC, "README.1st" (March 1, 2001).

J. S. Hendricks, "MCNP4C," LANL Memo X-5: JSH-2000-30 (U) (February 29, 2000).

J. F. Briesmeister, Ed., "MCNP - A General Monte Carlo N-Particle Transport Code, Version 4C," LA-13709-M (April 2000).

H. M. Abhold, J. S. Hendricks, "MCNP Software Quality Assurance Plan," LA-13138 (April 1996).

S. Frankle, "Compiling MCNP Version '4B' on VMS," LANL Memorandum (February 12, 1997).

T. Goorley, Informal Note on "MCNP4B in Parallel on PC's Running Linux" (July 22, 1997).

### b. background information:

D. J. Whalen, D. A. Cardon, J. L. Uhle, J. S. Hendricks, "MCNP: Neutron Benchmark Problems," LA-12212 (November 1993).

C. D. Harmon, II, R. D. Busch, J. F. Briesmeister, R. A. Forster, "Criticality Calculations with MCNP: A Primer," LA-12827-M (August 1994).

R. C. Little and R. E. Seamon, "Dosimetry/Activation Cross Sections for MCNP," LANL Memo (March 13, 1984).

## 11. CONTENTS OF CODE PACKAGE

Included are the referenced electronic documents in (10.a) and the source codes, test problems, PC executables, and installation scripts transmitted on CD ROM in DOS and UNIX format. The DLC-200/MCNPDATA data library is included on the distribution media; these cross sections are in ASCII mode in the Unix file and in binary mode for PC Windows users. A Lahey-compiled MAKXSF executable was used to create the binary cross sections in the PC distribution. See the README files for details on package contents and installation.

## 12. DATE OF ABSTRACT

April 2000, revised July 2000 and March 2001.

**KEYWORDS:** COMPLEX GEOMETRY; COUPLED; CROSS SECTIONS; ELECTRON;  
GAMMA-RAY; MICROCOMPUTER; MONTE CARLO; NEUTRON;  
WORKSTATION

**S  
E  
C  
T  
I  
O  
N  
  
1**

---

## 1.0 Copyright

---

MCNP was prepared by the Regents of the University of California at Los Alamos National Laboratory (the University) under Contract number W-7405-ENG-36 with the U. S. Department of Energy (DOE). The University has certain rights in the program pursuant to the contract and the program should not be copied or distributed outside your organization. All rights in the program are reserved by the DOE and the University. Neither the U. S. government nor the University makes any warranty, express or implied, or assumes any liability or responsibility for the use of this software.

---

## 2.0 MCNP4C

---

MCNP4C is the first major release of MCNP since version 4B (February 4, 1997).

The major new features of MCNP4C include:

- \* Unresolved resonance range probability tables;
- \* Perturbation enhancements;
- \* Superimposed mesh weight window generator;
- \* Alpha eigenvalues;
- \* Macrobodies;
- \* ENDF/B-VI improvements;
- \* PC Enhancements;
- \* Electron Physics Enhancements;
- \* Parallelization enhancements;
- \* Delayed Neutrons.

In addition, there are 30 minor features/enhancements and 65 corrections.

---

## 3.0 User Support

---

A LIMITED amount of free user support is available from John Hendricks, [mcnp@lanl.gov](mailto:mcnp@lanl.gov), and Judi Briesmeister, 505-667-7277. Users are encouraged to communicate with other users via the list server, [mcnp-forum@lanl.gov](mailto:mcnp-forum@lanl.gov). Our WWW Web site is: <http://www-xdiv.lanl.gov/XCI/PROJECTS/MCNP>

Contact [mcnp@lanl.gov](mailto:mcnp@lanl.gov) to be added to the MCNP e-mail list or to arrange additional support on a fee basis.

---

#### 4.0 DISTRIBUTION FILES

---

The following files should be present with the MCNP 4C distribution:

FILE	DESCRIPTION
Readme	This file.
INSTALL	Installation controller. Named INSTALL.BAT for PC Windows systems.
INSTALL.FIX	Installation fix file.
MCSETUP.ID	Setup FORTRAN code.
PRPR.ID	FORTRAN preprocessor code.
MAKXS.ID	Cross-section processor source code.
MCNPC.ID	MCNP C source code.
MCNPF.ID	MCNP FORTRAN source code.
RUNPROB	Script file for MCNP verification. Named RUNPROB.BAT for PC Windows systems.
TESTINP.TAR	Compressed input files for MCNP verification. Named TESTINP.ZIP for PC Windows systems.
TESTMCTL.SYS	Compressed tally output files for MCNP verification. Named TESTMCTL.ZIP for PC Windows systems.
TESTOUTP.SYS	Compressed MCNP output files for MCNP verification. Named TESTOUTP.ZIP for PC Windows systems.
TESTDIR	Cross-section directory for MCNP verification.
TESTLIB1	Cross-section data for MCNP verification.

Substitute the appropriate system identifier from the following table for the "SYS" suffix.

SYSTEM	IDENTIFIER	SYSTEM	IDENTIFIER
Cray UNICOS	ucos	DEC ALPHA	dec
PC DVF Windows	n/a	PC Lahey Windows	n/a
IBM RS/6000 AIX	aix	Sun Solaris	sun
HP-9000 HPUX	hp	SGI IRIX	sgi
PC LINUX	linux	VAX VMS	vms

The INSTALL.FIX file is used to implement corrections to either the MCNP source or the MAKEMCNP script. The latter is important for future changes/bugs in compilers and/or operating systems. The format of this file is provided within INSTALL.FIX, and more details can be found in Appendix C of the MCNP

manual. The MCSETUP utility is a user-friendly interface for creating system-dependent files. The remaining files in the first group are MCNP related source code, and the second group of files are used for MCNP verification (i.e. running the 29 MCNP test problems).

For PC Windows systems, one additional utility has been included: the archive utility PKUNZIP.EXE.

For the current version of MCNP4C, VMS is not a supported system, and hence, output templates have not been provided.

---

## 5.0 SYSTEM REQUIREMENTS

---

### Software Requirements:

(1) A FORTRAN 77 compiler. The supported compiler for each system is listed in the 1.1 MCSETUP menu (see below). The PC DVF compiler is FORTRAN 90 and the PC Lahey compiler is FORTRAN 95.

(2) A C compiler with an ANSI C library is required for UNIX system timing, as well as the X-Window graphics and dynamic memory allocation options. On PC Windows systems, the Microsoft Visual C++ compiler is required to implement the X-Window graphics and dynamic memory allocation options.

A Bourne-shell command interpreter is needed to execute the installation Script on UNIX systems.

### Hardware Requirements:

	Minimum	Recommended
RAM	2 Mbytes	16 Mbytes
Disk Space	50 Mbytes	100 Mbytes

---

## 6.0 GETTING STARTED

---

---

### 6.1 ON SUPPORTED SYSTEMS

---

Before proceeding, read the "IMPORTANT ADDITIONAL INFORMATION" section below.

On all systems, initiate the installation controller with the following commands:

COMMANDS	COMMENT
chmod a+x install ./install SYS	UNIX systems - SYS keyword given in the table above.
INSTALL	PC Windows systems

The MCSETUP utility is initiated first. Simply alter the main menu according to the MCNP options you desire. Note the following:

- (1) Section 1.1 of the main menu SHOULD BE ALTERED FIRST. This sets the appropriate computer system which in turn selects suitable defaults for the remaining options.
- (2) Default responses are indicated, and these will be activated by typing a <CR>. Additional options are also included, from which the user can select the desired configuration. Several user-specific parameters, such as the cross section data path, graphics library path, library name, and include path may be also entered.
- (3) If the dynamic memory option is turned "off", an appropriate value for the MDAS parameter should be set (default is mdas=4000000). In general MDAS should be greater than 100000 and less than  $(R-2)/4 * 1000000$ , where R is your available RAM in Mbytes.
- (4) More information on the setup options is available in the MCNP manual. If you are unsure as to graphics libraries available on your system or their location, contact your system administrator. Default library names and directory paths are supplied by the MCSETUP utility; however these may not be applicable to your system. A FATAL error message is displayed if needed libraries could not be located. Included in this error message is the expected library name and path.

When done altering the main menu, use the PROCESS command to continue the installation. The MCSETUP utility creates three system dependent files: the PRPR C patch file (PATCHC), the PRPR FORTRAN patch file (PATCHF), and the MAKEMCNP script. PATCHF and PATCHC include the \*define preprocessor directives that reflect the options chosen in the execution of the MCSETUP code. MCSETUP also creates an ANSWER file which contains the MCSETUP input for future installations. This file reflects all options chosen during the initial installation and can be used in future installations by

COMMAND(S)	COMMENT
./install SYS < answer	UNIX systems
INSTALL ANSWER	PC Windows systems

Next, the installation controller initiates the MAKEMCNP script which creates the MCNP executable. System differences can result in compilation errors (e.g., unsatisfied externals). If this occurs, contact MCNP@LANL.GOV regarding a fix. In most cases a two line fix can be added to your INSTALL.FIX file to rectify the situation (the INSTALL.FIX file included with the distribution contains examples of such fixes).

The last section of the installation controller performs MCNP verification by running the 29 MCNP test problems. If this step is to be omitted, rename the RUNPROB file with some other name (e.g., RUNPROB.ORG).

On most dedicated systems, compilation time is roughly 15-30 minutes and verification an additional 20-40 minutes.

---

## 6.2 VMS System

---

VMS is not currently a fully supported system. The following guidelines are included as an aide to the user.

On VMS systems, add the following line in your LOGIN.COM file to enable argument passing on the MCNP execution line:

```
MCNP := $MCNP_DISK:[MCNP_PATH]MCNP.EXE
```

where MCNP\_DISK and MCNP\_PATH are the disk and directory path to be used for the MCNP installation. To update this change, log back in or type @LOGIN.

To initiate the installation controller, enter COPY INSTALL.VMS INSTALL.COM, Followed by @INSTALL at the command line.

MCSETUP creates an ANSWER file that contains the MCSETUP input for future installations. This file reflects all options chosen during the initial installation and can be used in future installations by entering ASSIGN ANSWER.DAT SYSS\$COMMAND, followed by @INSTALL.

A successful compilation generates an MCNP executable called MCNP.EXE on VMS. The MCNP FORTRAN source will be called MCNP.FOR.

---

## 7.0 UPON COMPLETION

---

A successful compilation generates an MCNP executable, called mcnp on UNIX systems and MCNP.EXE on PC Windows systems. The MCNP FORTRAN source is split into subroutines, called subroutine.f on UNIX and subroutine.for on PC Windows, and is placed in the flib directory. The object code for individual subroutines is placed in the olib directory. A normal completion results in the following message:

Installation complete - see Readme file.

A log of the installation process is written to the INSTALL.LOG file.



An abnormal completion results in one of the following messages:

SETUP ERROR OR USER ABORT.

COMPILATION ERROR - see INSTALL.LOG file.

VERIFICATION ERROR - see INSTALL.LOG file.

The cause of the error can be found in the INSTALL.LOG file.

Upon completion of MCNP verification, 29 difm?? files will exist containing the MCNP tally differences between your runs and the standard. Similarly, the 29 difo?? files will contain the MCNP output file differences between your runs and the standard. Exact tracking is required for MCNP verification, thus significant differences (i.e. other than round-off in the last digit) may prove to be serious (e.g. compiler bugs, etc.). In such cases the INSTALL.LOG file should be reviewed to ensure that the 29 test problems ran successfully.

On all systems, EXACT tracking of ALL the test problems is required to verify proper code installation. If you do not track exactly of the code crashes running the test problems, recompile using a lower optimization and try again. If errors persist without optimization, try compiling without graphics. Approximately 99% of installation problems are due to compiler optimization bugs, compiler bugs, bad graphics libraries, or bad operating system environments.

---

## 8.0 IMPORTANT ADDITIONAL INFORMATION

---

The install.fix file contains directives to generate debuggable versions of the code for all the supported systems. In order to activate this capability, uncomment the specified lines for the system of interest. In particular, delete the leading "c" plus one blank space for the indicated number of lines.

---

### 8.1 Cray UNICOS

---

None

---

### 8.2 PC DVF Windows

---

For the PC Windows systems, the supported operating systems are Windows NT/9x. The code can be installed and run from a DOS command line prompt.

The following combination of software packages are required to achieve full functionality with MCNP on the PC DVF Windows system:

PACKAGE	VERSION	COST
Digital Visual Fortran Professional Edition <a href="http://www.digital.com/fortran/dvf">http://www.digital.com/fortran/dvf</a> This product is now also known as Compaq Visual Fortran.	6.0	\$799
Microsoft Visual C++ Professional Edition <a href="http://msdn.microsoft.com/visualc">http://msdn.microsoft.com/visualc</a>	6.0	\$549

Two graphics systems are supported: X-windows graphics and DVF QuickWin.

It is important that your Path, Include, and Lib environment variables are set accordingly. To verify or modify these settings on your PC, go to Start --> Settings --> Control Panel --> System --> Environment. See the DVF and Microsoft Visual C++ manuals for appropriate settings.

The X-windows library, X11, release 6.4, X11R6.4, can be downloaded free-of-charge from the web-site "<http://www.x.org>". This site contains the code needed to generate the X-windows libraries to display MCNP geometry, cross section and tally plots. In addition, an X-windows server is required to display the graphics. Suggested servers include ReflectionX, Exceed, and X-Deep/32. It should be noted that the development versions of the X-servers, which may be more expensive than the standard versions, also include the additional software necessary to generate the X11R6 development libraries. For this application, a custom installation of the X-servers is recommended.

The following are guidelines for installing the X-Windows graphics from the [www.x.org](http://www.x.org) download.

It is first necessary to unpack the X11R6.4 source code release distribution (use WinZip), compile it, and then install it. The distribution includes imake files, library files, fonts, language support files, auxiliary programs, as well as detailed documentation. The imake utility, included in the distribution, creates system-specific Makefiles from system-independent Imakefiles. The system-dependent configuration parameters are defined in the file site.def. There is a sample site.def (called site.sample) included in the distribution. Copy this file to site.def and add the following as the second line in the file:

```
#define RmTreeCmd del /q /s
```

When installing X11R6.4, is it necessary to create the following subdirectories a priori:

```
\exports\include
```

```
\exports\lib
```

Follow the directions in the documentation to build the libraries, and type the following line in your local directory:

```
nmake World.Win32 > world.log
```

After the build has had a successful completion, install the software by typing:

```
nmake install > install.log
```

The generated files will include X11.lib and Xlib.h, which are required for the X-Windows graphics version on PC Windows systems.

The MCSETUP utility will query the user on the graphics library path, library filename, and include path only for the X-windows graphics option for the PC Windows systems. There are default graphics paths, libraries, and include paths which can be changed upon installation.

For the DVF QuickWin graphics, the execution of each problem terminates with the following message displayed: "Program Terminated with exit code 0. Exit Window? (yes,no)". Simply respond by clicking "yes".

In addition, on all PC Windows systems, the graphics plots can be saved to a postscript file using the FILE command at the PLOT or MCPLLOT prompt. These postscript files can be sent to any postscript-ready printer for printing in color or black and white.

The archive utility PKUNZIP.EXE can also be downloaded free-of-charge as a Shareware version:  
<http://www.pkware.com>

---

### 8.3 IBM AIX

---

None

---

### 8.4 HP HPUX

---

None

---

### 8.5 PC LINUX

---

The dynamic memory option (pointer) is not currently available with the LINUX system with the supported operating system and compiler.

For the LINUX system, using Redhat 6.0, there is a known bug with the g77 compiler, version 05.24. Installation and execution with this compiler version results in a verification error; the code fails to execute test problem 14, which uses the like-but construct. This bug has been rectified in version 05.25, which we support.

For the LINUX system, the fsplit utility is available to be downloaded free-of-charge from the following web-site.

<http://rufus.w3.org/linux/RPM/contrib/libc5/i386/fsplit-1.0-1.i386.html>

---

## 8.6 DEC ALPHA

---

None

---

## 8.7 PC Lahey Windows

---

The following combination of software packages are required to achieve full functionality with MCNP on PC Lahey Windows system:

PACKAGE	VERSION	COST
Lahey Fortran 95 LF95 PRO v5.5 Professional Edition <a href="http://www.lahey.com">http://www.lahey.com</a> This product is now also known as Lahey/Fujitsu Fortran 95.	5.50h	\$795
Microsoft Visual C++ Professional Edition <a href="http://msdn.microsoft.com/visualc">http://msdn.microsoft.com/visualc</a>	6.0	\$549

---

Two graphics systems are supported: X-windows graphics and Lahey Winteracter.

Please see the PC DVF Windows section for additional applicability to the Lahey Fortran system.

For the Lahey Winteracter graphics, it is necessary to move all open windows to the periphery of the windows screen in order to be enable visualization of the plot. In addition, when executing the Lahey Winteracter version, it is recommended to minimize the number of additional open windows in your system.

The Lahey Fortran system does not include the fsplit utility. For LF95, the Fortran 77 source code for the fsplit utility can be downloaded free-of-charge from the following web-site:

<http://members.aol.com/~Draine3/fsplit.html>

After downloading the source, compile the source under the Lahey Fortran 95 compiler, and specify name the executable as fsplit.exe.

Place this file in your local directory file-space when installing the code.

The dynamic memory option (pointer) is not currently available with the PC Lahey Fortran system with the supported operating systems.

---

8.8 Sun Solaris

---

None

---

8.9 SGI IRIX

---

None

**S  
E  
C  
T  
I  
O  
N  
  
2**

## README.1st for MCNP4C & MCNPDATA

\*\*\*\*\*

### QUICK START on Unix

```
gunzip -c /cdrom/c700tar2.gz | tar xvf -
```

```
gunzip -c /cdrom/d200tar2.gz | tar xvf -
```

Compile and run test cases as instructed in README.TXT.

\*\*\*\*\*

### QUICK START on PC

Insert distribution CD-ROM and access CD-ROM drive

Double-click on the file c700dos2.exe and expand files.

Open a DOS window and compile as instructed in README.TXT or copy an MCNP executable from the EXE subdirectory and run test cases. Copy the xsdir2 file which corresponds to the executable selected before attempting to use the binary MCNPDATA cross sections in \mcnp\xs.

```
cd \mcnp
```

```
copy exe\mcnp4_if.exe mcnp.exe      (copy Lahey-compiled MCNP - MDAS=4,000,000)
```

(Test cases use TESTDIR and TESTLIB1.)

```
runsamps
```

(Run 29 test cases then examine dif\* files  
to verify that they ran successfully.)

After running test cases, you should copy the xsdir2 file to the directory in which you will run real MCNP problems. This file points to the binary DLC-200 cross sections, which are expanded to mcnp\xs. The first line of the xsdir file can be used to tell mcnp where to find cross sections. If you do not use the default installation path (\mcnp\xs), simply edit xsdir and change the path to your directory. The following commands can be typed to copy the xsdir for use with a Lahey executable.

```
cd \mcnp
```

```
copy exe\xsdir2_if xsdir
```

(xsdir2 file written by Lahey-compiled  
MAKXSF for binary MCNPDATA in mcnp\xs)

Additional details on package contents and installation are provided in the remainder of this file.

\*\*\*\*\*

### General info on package contents

ALERT: Extracting files from the distribution CD will create a subdirectory called "mcnp". It is recommended that you rename any existing "mcnp" subdirectory in the root of the drive to which you are installing.

This distribution includes the LANL MCNP4C code system plus MCNPDATA cross sections for both Unix and Windows operating systems. In RSICC's collection, the packages are identified as C00700ALLCP01 MCNP4C and D00200ALLCP01 MCNPDATA.

After expanding files to your hard drive, see mcnp/Readme.txt for an explanation of files and information on compiling and running MCNP4C.

Fortran and C compilers are required on Unix systems. Executables are provided for PC Windows users. If you prefer to build your own executables, installation procedures are provided for Lahey F95 and Digital Visual Fortran. A C compiler is required on PC to build an executable with dynamically allocated storage using DVF. This option does not work with the LF95 compiler. If no C compiler is available, set the MDAS parameter in the installation procedure.

Various "ANSWER" files created by MCSETUP are distributed in a subdirectory and may be used as input to MCSETUP. Running test cases is recommended on all systems. Be sure to review dif\* files and determine that your results are the same as those provided by LANL. The file "testlib1" is included in the MCNP code package for verification purposes and is not intended for use with other calculations.

MCNPDATA Readme.txt and Readme\_endf60.txt contain brief descriptions of the data libraries and are distributed with the cross sections in the mcnp/xs subdirectory. Note that the trailing "1" was dropped from file names for Type 1 (ASCII) libraries.

Expanding the code system (50 MB) and binary cross section libraries (360MB) under Windows requires ~410 MB of hard disk space. Unix users need more because the ASCII cross sections require ~880 MB of hard disk space.

The MCNP4C and MCNPDATA manuals are distributed on the CD in the "DOC" subdirectory in Portable Document Format (PDF) for viewing with the Adobe Acrobat Reader and are not distributed in printed (hardcopy) form. To view files electronically, Acrobat Reader must be installed on your computer. It may be downloaded from: <http://www.adobe.com/acrobat/readstep.html>

The files C700DOC.PDF and D200DOC.PDF are indexed. To enable this feature, click on the Acrobat Reader command bar to "show/hide navigation pane". Note that C700DOC.PDV now includes the complete MCNP4C documentation released by LANL in December 2000.

The MCNP web site at <http://www-xdiv.lanl.gov/XCI/PROJECTS/MCNP>. The Electronic Notebook at <http://www-rsicc.ornl.gov/rsic.html> contains information on user experiences with MCNP. See the site for more detailed instructions on installing under windows as well as compiler notes. If installation questions arise, e-mail [pdcc@ornl.gov](mailto:pdcc@ornl.gov) and include the exact error message to aid in diagnosing problems.

#### -----UNIX & LINUX USERS-----

Unix users should expand and extract software from the compressed tar files distributed on CD, then follow instructions in the mcnp/Readme.txt file. Test case results are not provided for DEC users, who are advised to compare with Sun results. This may be accomplished by copying the testoutp.sun to testoutp.dec and testmctl.sun to testmctl.dec before invoking the install script.

Mount the CD-ROM (called "cdrom" in this example) and issue the following commands to extract files into a subdirectory called "mcnp" which will be created under your present working directory. The ASCII (type 1) cross sections will be written to a subdir called "mcnp/xs" and may be converted to binary (type 2) format using MAKXSF.

```
gzcat /cdrom/c700tar2.gz | tar xvf -
gzcat /cdrom/d200tar2.gz | tar xvf -
```

or

```
gunzip -c /cdrom/c700tar2.gz | tar xvf -
gunzip -c /cdrom/d200tar2.gz | tar xvf -
```



-----PC WINDOWS USERS-----

The MCNP4C code system is transmitted in a compressed file for PC users running Windows 9x or NT. PKware 2.60 was used to create the self-extracting compressed files for Windows users which contain both the MCNP4C code system with executables and cross-sections from MCNPDATA in binary format for use on PC. Note that the mcnp executables are not Windows applications; they must be run from a DOS prompt.

The initial MCNP4C release included DVF executables. In June 2000, Lahey executables were added so that the distribution CD now includes both DVF and Lahey MCNP executables. Some users who often do batch processing prefer to run the Lahey executables because the DVF executable requires the user to click "Yes" to close the execution window after each run.

The PC distribution contains executables for MCNP, PRPR and MAKXSf which were built in a DOS window of Windows NT using compilers: Digital Visual Fortran 6.0A and Lahey/Fujitsu Fortran 95 Compiler Release 5.50d

The Lahey-compiled MAKXSf.EXE was used to process the MCNPDATA ASCII cross sections to create the binary files which are distributed in the \mcnp\xs subdirectory. Both DVF- and Lahey-compiled MCNP executables can read these files provided the corresponding XSDIR2 file is copied from the "exe" subdirectory to the working directory. Recl in the Lahey and DVF xsdir2 files is different because Lahey expects record length in bytes, and DVF expects them in 4-byte units.

PC users may choose to use the binary cross sections distributed in this package or may use the ASCII cross sections in the compressed MCNPDATA file on the CD called d200tar2.gz. This file was created with tar and GNU gzip on a Unix workstation. Several utilities are available to expand Unix compressed files on pc. One such utility is WinZip: <http://www.winzip.com/winzip.htm>

The GNU gzip and tar utilities may be downloaded at no charge and can be used to expand and extract data from the distribution file.

<ftp://ftp.gnu.org/pub/gnu/>

Click on "gzip" then get gzip-1.2.4.msdos.exe and expand it on the PC.  
Type "gzip -d d200tar2.gz"

<ftp://ftp.gnu.org/gnu/tar/>

Get tar-1.12.msdos.exe then rename it to tar.exe and invoke by typing  
"tar xvf d200tar2"

Note that this version of tar will truncate long filenames to conform to DOS naming conventions.

---

Expanding files from the distribution CD will create a subdirectory called "mcnp" that includes the code system with binary cross sections written in the \mcnp\xs subdirectory, which is the default directory from which the distributed executable expects to read cross section libraries.

To install MCNP4C and MCNPDATA to a Pentium running Windows 95 or later, double-click on the file c700dos2.exe, ensure that "Recreate Subdirectories" is enabled and change drives if desired. Then click OK to create an MCNP subdirectory and begin extraction of files from the CD.

See the mcnp\Readme.txt file for instructions on building the executables. If you wish to use the executables included in the package, a RUNSAMPS.BAT file is provided to build a "samples" subdirectory, extract sample problem files and invoke RUNPROB.BAT. To run test cases, open a DOS window and change directories to the drive on which MCNP was installed, then change directories to the mcnp subdirectory and type "runsamps".

The executables are distributed in a subdirectory called "exe". One must copy the selected executable to the main mcnp subdirectory and rename it to "mcnp.exe" before executing the RUNPROB or RUNSAMPS batch files. Copy the xsdir file which corresponds to the executable selected before using the binary cross sections in \mcnp\xs.

#### Contents of MCNP\EXE subdirectory

fsplit.exe (can be used when compiling with LF95)  
makxsf\_dvf.exe DVF-compiled MAKXSF  
makxsf\_if.exe LF95-compiled MAKXSF  
mcnp\_dvf.exe DVF-compiled MCNP with dynamically allocated storage  
mcnp4\_if.exe LF95-compiled MCNP with MDAS=4,000,000  
mcnp8\_if.exe LF95-compiled MCNP with MDAS=8,000,000  
mcnp32\_if.exe LF95-compiled MCNP with MDAS=32,000,000  
xsdir2\_dvf XSDIR for use with binary MCNPDATA in \mcnp\xs & DVF MCNP  
xsdir2\_if XSDIR for use with binary MCNPDATA in \mcnp\xs & LF95 MCNP

LANL results for running the test cases with both of these compilers are included in the distribution file. The RUNPROB script compares results from the Lahey compiled executable. DVF users should copy TESTOUTP.DVF to TESTOUTP.ZIP and TESTMCTL.DVF to TESTMCTL.ZIP before running test cases.

On a Pentium III 550 mhz in a DOS window of Windows NT, the MCNP4C DVF executable runs all test cases in 2 min 25 seconds. With the Lahey F95 executable, all test cases ran in 2 minutes 45 seconds.

---

For the Lahey Winteracter graphics, it is necessary to move all open windows to the periphery of the windows screen in order to be able visualization of the plot. When executing the Lahey Winteracter version, it is recommended to minimize the number of additional open windows in your system. One can invoke the plot option by adding "ip" to the command line.

```
mcnp name=InpFile xsdir=xsdir2 ip
```

Please note the file XSDIR included in the PC distribution contains "DATAPATH=\mcnp\xs". If one alters the default directory structure, one must manually edit the DATAPATH statement. MCNP requires the file XSDIR as input. The included mcnp.exe will find XSDIR in the directory in which the executable resides or in the directory from which the job is submitted assuming one does not alter the default directory structure.

```
mcnp name=InpFile xsdir=xsdir2
```

RSICC April 10, 2000  
revised July 12, 2000 and February 28, 2001

**S  
E  
C  
T  
I  
O  
N**

**3**

# Los Alamos

NATIONAL LABORATORY

## memorandum

*Applied Physics Division*  
*X-5: Diagnostic Applications*

To/MS: Distribution  
From/MS: John S. Hendricks/X-5 F663  
Phone/FAX: (505)667-6997  
Symbol: X-5:JSH-2000-30 (U)  
Date: 29 February 2000

**Subject: MCNP4C**

### Contents

- I. Introduction
- II. Availability
- III. Major New Features
- IV. Minor New Features
- V. Corrections
- VI. Acknowledgements

### I. Introduction

MCNP4C<sup>TM1</sup> has been released to the Radiation Safety Information Computational Center (RS-ICC) in Oak Ridge, TN, (pdc@ornl.gov) for international distribution according to Department of Energy (DOE) policy.

Major new features are:

1. Unresolved resonance range probability tables;
2. Perturbation enhancements;
3. Superimposed mesh weight window generator;
4. Alpha eigenvalues;
5. Macrobodies;
6. ENDF/B-VI improvements;
7. PC Enhancements;
8. Electron Physics Enhancements;
9. Parallelization enhancements;
10. Delayed Neutrons.

In addition there are 30 minor features/enhancements and 65 corrections.

---

<sup>1</sup>MCNP is a trademark of the Regents of the University of California, Los Alamos National Laboratory

MCNP4C is guaranteed to be the most robust MCNP version ever. I will pay you \$20 if you can find any error that has been added since MCNP4B.<sup>2</sup> I will pay you \$4 in new \$2 bills if you can find a bug persisting from pre-4B versions of MCNP. The list of MCNP4B cash award winners is given in Section V, "Corrections."

I hereby certify MCNP4C has been developed in accordance with the MCNP Software Quality Assurance Plan<sup>3</sup>, including extensive regression testing, auxiliary testing, and independent reviews. These Software Quality Assurance practices are modeled after and, we believe, comply with, the ISO-9000<sup>4</sup> and IEEE<sup>5</sup> SQA standards.

## II. Availability

MCNP4C, including source files and documentation<sup>6</sup>, is available from the Radiation Safety Information Computational Center (RSICC) in Oak Ridge, TN, (pdc@ornl.gov) for international distribution according to Department of Energy (DOE) policy.

LANL users can get executables for many systems from the Common File System (CFS) at Los Alamos node:

/x5code/mcnp4c/exe

We will consider installing MCNP on various networks throughout LANL and for former sponsors. Contact Russ Mosteller, mosteller@lanl.gov.

Only sponsors and collaborators can get MCNP4C directly from the MCNP Monte Carlo Team in the Diagnostic Applications Group (X-5) of the Applied Physics Division (X) at Los Alamos National Laboratory.

## III. Major New Features

### 1. *Unresolved resonances:* (Lee Carter, Bob Little)<sup>7</sup>

The probability table treatment for unresolved resonance range cross sections is used whenever the appropriate data libraries are available. The unresolved treatment has been shown to have

---

<sup>2</sup>Cash for bugs offer may be cancelled at any time without notice. X-5 group members ineligible. A bug is defined as a correction to an officially distributed X-5 version of MCNP. Awards are \$20 for errors in MCNP4B or later versions; \$4 for pre-MCNP4B version errors. Awards are paid only for the first identification of a bug. Awards are not funded by taxpayer money, but rather voluntarily raised by the MCNP code developers as a sign of their confidence in the code.

<sup>3</sup>Hilary M. Abhold, John S. Hendricks, "MCNP Software Quality Assurance Plan," Los Alamos National Laboratory Report, LA-13138 (April 1996)

<sup>4</sup>ISO (International Organization for Standards), "ISO 9000 — International Standards for Quality Management," 2nd Edition, ISO Central Secretariat, Case postale 56, CH-1211, Geneve 20, Switzerland (1992)

<sup>5</sup>"IEEE Software Engineering Standards Collection," Institute of Electrical and Electronics Engineers, Inc., 345 East 47th Street, New York, NY 10017-2394 (April 5, 1991)

<sup>6</sup>J. F. Briesmeister, Ed., "MCNP - A General Monte Carlo N-Particle Transport Code — Version 4C, LA-12625-M (March 2000) (to be published)

<sup>7</sup>L. L. Carter, R. C. Little, J. S. Hendricks, "New Probability Table Treatment in MCNP for Unresolved Resonances," 1998 Radiation Protection and Shielding Division Topical Conference on Technologies for the New Century, Sheraton Music City, Nashville, TN, vol. II, p. 341 (April 19-23, 1998)

a significant effect for plutonium critical assemblies with intermediate spectra and substantial increases in reactivity for systems with a large amount of  $^{238}\text{U}$  and intermediate spectra <sup>8</sup>. Addition of the unresolved treatment to MCNP enables use of the latest ENDF/B-VI data and improves the modeling of resonance self shielding.

*User interface changes:* 3rd entry on PHYS:N card will use average cross section rather than probability table in all probability table libraries, enabling a comparison of the effect of using the probability tables. Also, "ptable" is required in the cross section directory for probability table libraries, which affects the XS card and MAKXSF auxiliary code. . .

2. *Perturbation enhancements:* (Lee Carter, John Hendricks, Gregg McKinney) <sup>9</sup>

The differential operator perturbation capability has been extended to cross section dependent tallies. The perturbed track length  $k_{eff}$  estimator is automatically printed in KCODE problems with PERT cards. This extension greatly enhances the usefulness of the perturbation capability in criticality problems or problems with heating tallies (F6, F7) or problems with FM cards applied to track length (F4) tallies.

3. *Superimposed mesh weight window generator* (Tom Evans, Jeff Favorite, John Hendricks)

The superimposed mesh weight window generator (MWWG) enables users to set up geometries without the addition of extra cells and surfaces for geometric importances or cell-based weight windows. The MWWG links to Justine and AVATAR and is similar to work done at North Carolina State University <sup>10 11</sup>. The MCNP4C superimposed mesh weight window generator (MWWG) was developed by Tom Evans and Jeff Favorite. References: XCI:TME-97-228, XCI:JAF-98-125, XCI:JAF-99-37, and XCI-RN(U):JSH-99-013. It is really a significant advance in Monte Carlo and has won a "best paper" award from the American Nuclear Society. <sup>12</sup>

As part of the MWWG package, the cell-based weight windows and the cell-based weight window generator were rewritten as well. A full assessment of the MWWG was published by Chris Culbertson <sup>13</sup> The user interface is fully described in Jeff Favorite's memo, XCI:JAF-99-37, copies of which are available from him, 505-667-7941, X-5, MS F663.

4. *Alpha eigenvalues* (Ken Adams, Art Forster)

---

<sup>8</sup>Russell D. Mosteller and Robert C. Little. "Impact of MCNP Unresolved Resonance Probability-Table Treatment on Uranium and Plutonium Benchmarks," Proceedings of the Sixth International Conference on Nuclear Criticality Safety, September 20-24, 1999, Palais des Congres, Versailles, France, Vol. 2, pgs. 522-531 (September 1999)

<sup>9</sup>A. K. Hess, J. S. Hendricks, G. W. McKinney, "Verification of the MCNP Perturbation Correction Feature for Cross-Section Dependent Tallies," Los Alamos National Laboratory Report, LA-13520 (October 1998)

<sup>10</sup>L. Liu, R. P. Gardner, "A Geometry-Independent Fine-Mesh-Based Monte Carlo Importance Generator," Nuclear Science and Engineering, 125, pp. 188-195 (1997)

<sup>11</sup>R. P. Gardner, Lianyan Liu, "Monte Carlo Simulation of Neutron Porosity Oil Well Logging Tools: Combining the Geometry-Independent Fine-Mesh Importance Map and One-Dimensional Diffusion Model Approaches," Nuclear Science and Engineering, Vol 133, p. 80-91 (1999)

<sup>12</sup>T. M. Evans, J. S. Hendricks, "An Enhanced Geometry-Independent Mesh Weight Window Generator for MCNP," 1998 Radiation Protection and Shielding Division Topical Conference on Technologies for the New Century, Sheraton Music City, Nashville, TN, vol. I, p. 165 (April 19-23, 1998)

<sup>13</sup>C. N. Culbertson, J. S. Hendricks, "Assessment of MCNP4C Weight Windows," Los Alamos National Laboratory Report, LA-13668 (December 1999)

The MCNP4C Alpha eigenvalue calculator<sup>14</sup> was developed by Ken Adams and Art Forster. The alpha eigenvalue is

$$N = N_0 e^{\alpha t}$$

where  $N$  is the neutron population at some time  $t$  that builds up from some initial population  $N_0$ . Alpha is of interest for comparison to benchmark calculations and comparison to deterministic transport codes such as DANTSYS. The units of alpha are generations/shake. The alpha capability allows positive and negative alpha searches and a fixed positive or negative alpha value to be used in a  $k_{eff}$  eigenvalue calculation. Negative values of alpha can result in a time creation (n,2n) delta scattering reaction. Positive alpha is treated as time absorption.

The alpha user interface consists of an additional entry on the KCODE card to impose a value of alpha in a KCODE calculation; or the new ACODE card can be used to search for alpha. The complete KCODE and ACODE card descriptions are in Appendix A.

#### 5. *Macrobodies* (Lee Carter)

The MCNP surface-sense geometry is general, flexible, and very powerful. It is also very difficult to specify at times. For example, consider specification of a hexagonal prism within an hexagonal prism. The MCNP4B geometry input is presented in Appendix B. The new MCNP4C macrobodies are much simpler, as also specified in Appendix B.

The MCNP4C macrobodies are basically the body geometry in the Integrated Tiger<sup>15</sup> (ACCEPT) format and they can be mixed with other MCNP surfaces. The bodies are BOX, RPP, SPH, RCC, RHP, and HEX. These are further specified in Appendix C.

The facets of macrobodies are specified in Appendix D. The facets of the RHP in the input file example of Appendix B for surface 10 would be 10.1, 10.2, 10.3, 10.4, 10.5, 10.6, 10.7, and 10.8, corresponding to surfaces 11, 12, 13, 14, 15, 16, 17, 18 in the MCNP4B input file example. You can use facets of a macrobody for tallying, tally segments, defining other cells, or SDEF sources starting on facets.

When plotting macrobody surfaces, a new plot command, MBODY, allows you to plot the surface facet numbers (mbody off) or just the macrobody surface number (mbody on) (default).

#### *Known Deficiencies of MCNP4C Macrobody Implementation:*

- (a) Specifying a facet for surface read or write: SSR or SSW.
- (b) Specifying a facet for a flagged surface. Now gives error message if a floating point surface is entered.
- (c) Items that may involve a facet in PTRAK.
- (d) May want to include the facet number along with the surface number in writing to and reading from MCTAL files.

#### 6. *ENDF/B-VI ver. 5 Capabilities* (Morgan White)

<sup>14</sup>D. Brockway, P. Soran, and P. Whalen, "Monte Carlo Eigenvalue Calculation," Lecture Notes in Physics, "Monte-Carlo Methods and Applications in Neutronics, Photonics, and Statistical Physics," Proceedings, Cadarache Castle, France, 1985, Springer-Verlag, Berlin, ISBN 3-540-16070 (1985)

<sup>15</sup>J. A. Halbleib, R. P. Kensek, T. A. Mehlhorn, G. D. Valdez, S. M. Seltzer, M. J. Berger, "ITS Version 3.0: The Integrated TIGER Series of Coupled Electron/Photon Monte Carlo Transport Codes," Sandia National Laboratories report SAND91-1634 (March 1992)

The nuclear data sampling routines were modified to enable utilization of the forthcoming ENDF65 neutron data library<sup>16</sup>. Tabular-angular sampling distributions are added to the MCNP ACE (A Compact ENDF) format for representing angular information in finer detail than through the 32 equi-probable bin distribution<sup>17</sup>. Further, neutrons and photons are now handled consistently within the energy-sampling portion of laws 4, 44, and 61, which use emission-energy tables. Finally, nearest integers were used to correct problems when using single-precision data to carry large pointers<sup>18 19</sup>.

7. *PC Enhancements* (Lee Carter/Gregg McKinney)

MCNP can now compile on PC's with FORTRAN 90/95 using either Lahey (Version LF95 5.50h) or Digital Visual Fortran (DVF Version 6.0) compilers. Plotting is with an X-window interface using either compiler, or can optionally be with regular Windows using Lahey with its Winteracter plotting package or Digital Visual Fortran with its QuickWin plotting package. A linux capability is also provided.

8. *Electron Physics Enhancements* (Ken Adams)

Electron physics enhancements were made to make MCNP more current with the Integrated Tiger Series (ITS)<sup>20</sup>. Improvements have been made to

- (a) Density effect calculation for stopping power;
- (b) Radiative stopping power;
- (c) Bremsstrahlung production (spectra intensity and angular distribution);
- (d) Impact ionization.

A new electron library, EL03, has also been prepared with better data.

Further, electrons have been cleaned up to (1) correct a few minor problems; (2) improve numerical instabilities inherited from the Integrated Tiger Series; (3) isolate functionality in separate subroutines; and (4) provide stylistic consistency with the rest of MCNP<sup>21</sup>.

The MCNP material card (Mn) now allows specification of conductors (cond = 1) analogous of the MCNP4B specification of gaseous media (gas = 1).

9. *Parallelization enhancements* (Larry Cox)

In MCNP4C the ability to compute on massively parallel platforms has been enhanced. Distributed memory multiprocessing (DMMP) and shared memory multiprocessing (SMMP) methods are both supported — separately or in combination.

DMMP is supported through PVM<sup>22</sup>. SMMP is supported through compiler directives and system-provided subroutines on CRAY, IRIX and DEC systems. These directives and sub-

<sup>16</sup>Morgan C. White, "Modification to the MCNP ACE Routines," XCI:MCW-99-80 (9/15/99)

<sup>17</sup>Morgan C. White, "Verification of the ACE Modifications to MCNP," XCI:MCW-99-92 (9/15/99)

<sup>18</sup>John S. Hendricks, "MCNP4C ENDF65 Capability," X-5:JSH-99-08 (11/3/99)

<sup>19</sup>Morgan C. White, "Response to X-5:JSH-99-08," X-5:MCW-99-17 (12/2/99)

<sup>20</sup>J. A. Halbleib, R. P. Kensek, T. A. Mehlhorn, G. D. Valdez, S. M. Seltzer, M. J. Berger, "ITS Version 3.0: The Integrated TIGER Series of Coupled Electron/Photon Monte Carlo Transport Codes," Sandia National Laboratories report SAND91-1634 (March 1992)

<sup>21</sup>John S. Hendricks, "MCNP Electron Physics Enhancements," X-5:JSH-99-19 (12/6/99)

<sup>22</sup>A. Geist, et.al., "PVM 3 User's Guide and Reference Manual," ORNL/TM-12187



routines can be mapped on the OpenMP <sup>TM</sup> <sup>23</sup> standard in a one-to-one fashion. Porting the SMMP functionality to other systems will be straightforward. The addition of threading allows efficient computation on shared-memory platforms such as SGI Origin2000 (ASCI Blue Mountain) hardware.

By combining shared memory threading with distributed memory multiprocessing, most MCNP calculations can be run efficiently on large numbers of processors for high throughput. Clusters of multi-processor computers can be linked together to do a single calculation. Calculation of memory intensive problems is also enhanced by the use of read-only shared memory; only that which each thread needs to change need be duplicated.

Care has been taken to ensure that the same answer will be obtained from any processor configuration for almost all problem types. Extensive testing has been done on 2000+ processors with some calculations run on all 6144 processors of the ASCI Blue Mountain machine.

*User interface change:* On the MCNP execution line, tasks NxM specifies N PVM tasks and M threads. Tasks K specifies K threads or PVM processes if only PVM is available.

#### 10. *Delayed Neutrons* (Chris Werner)

A time-dependent delayed neutron treatment now produces a more accurate fission model in fixed-source and criticality calculations <sup>24</sup> <sup>25</sup>. A natural sampling of prompt and delayed neutrons is now the default for KCODE or when TOTNU is specified. An additional delayed neutron biasing scheme is available because of the low probability of a delayed neutron occurrence.

*User interface change:* A fourth entry, DNB, is added to the PHYS:N card:

DNB = -1 : Use delayed neutrons if total  $\nu$  (TOTNU card) is used and if delayed neutron data are in the data library (default);

DNB = 0 : Turn off delayed neutrons and use prompt treatment (present MCNP4B method);

DNB > 0 : Produce an average of DNB delayed neutrons per fission in addition to the natural sampling of prompt neutrons (no more than 11 prompt plus delayed neutrons allowed per fission.)

### IV. Minor New Features

1. *New Installation Files:* The MCNP installation files have been upgraded for MCNP4C and newly supported systems. These files include INSTALL, INSTALL.BAT, INSTALL.FIX, MCSETUP.ID, README. (ECS) 2/28/00

**NOTE:** The XS64 option is now the default for compiling MCNP which means cross sections on 32-bit machines are no longer stored single precision. Where there are few cross sections, the extra size does not matter. Where there are many cross sections, the extra size is crucial so that pointers in the cross section data have more than 7-digit precision.

2. *MCNP4B tracking:* MCNP4C will track MCNP4B for most problems by setting the 20th entry on the DBCN card to 1. Exceptions are some feature combinations such as forced collisions and weight windows and some cases where MCNP4B was incorrect. (JSH, others)

<sup>23</sup> OpenMP: <http://www.openmp.org>

<sup>24</sup> Christopher J. Werner, "Modifications for MCNP4XT to Include a Delayed Neutron Treatment for Secondary Neutrons Produced from Fission," XCI:CJW-99-94 (9/14/99)

<sup>25</sup> John S. Hendricks, "MCNP4C Delayed Neutrons," X-5:JSH-99-10 (11/9/99)

3. *Cumulative tallies*: Tallies may now be cumulative with correct variances supplied automatically.  
*User interface changes*: On any tally bin card (FU, FS, FM, C, E, T) adding a "C" makes the bins cumulative. (JSH, XCI:JSH-98-39) 03/17/98
4. *Add pause command to plotter*: A series of geometry or tally plots may now be plotted from a command file (MCNP manual <sup>26</sup> page B-3, "COM command") in which the new "PAUSE n" command holds each picture for n seconds. If n is not provided, then each picture remains until the return key is struck. (JSH) 12/18/97
5. *Add level command to geometry plotter*: The "LEVEL n" command causes a repeated structures geometry to plot only the nth level. A negative entry (default) causes the geometry at all levels to be plotted. (JSH) 12/18/97
6. *Restructure common*: Common has been rewritten to facilitate expansion, merger with MCNPX/LAHET, and multitasking with massively parallel computers such as ASCI Mountain-Blue. (LJC) 09/23/98
7. Print default importances. (RAF/JSH) 04/15/98
8. Enable tallying on TRCL-created surfaces. (JFB/GWM/JSH) 04/21/98
9. Enable interrupts on 64-bit SGI (-I8 -R8 compilation) (JSH) 06/29/98
10. Enable execution line messages on 64-bit SGI. (LJC) 07/02/98
11. Provide cleaner separation of LINUX and DEC. (GWM) 06/04/97
12. Move load date and data path to very front of code so INSTALL.FIX can modify common and yet INSTALL can still adjust DATAPATH. (JSH) 10/09/98
13. Add lots of warnings.
14. Turn off debug print and event log for multitasking. (JSH) 08/13/98
15. Add error trap for KCODE source on boundary. (JSH) 02/09/97
16. Eliminate 4A tracking fixes. (JSH) 05/01/97
17. Added suggested improvements, David Turland, dturland@awe.co.uk, for xs64 option 08/25/98
18. Turn off DD diagnostics if prdmp 2j -2 (JSH) 04/21/98
19. Make scoring to a tally both in and out of a DXTRAN sphere a warning, not bad trouble. (MCNP manual change: page 2-91, 9th line from bottom.)
20. Enable plotting parallel to axis of hex prism lattices (JSH) 05/04/99 This mostly (but not totally) corrects a limitation we've had for ten years.
21. Can now read 'cell' as well as 'cel' on SSW, SSR, SDEF cards ...
22. Warnings were added to indicate if cross sections are adjusted for thermal broadening. (RCL/JSH) 3/08/99 Check made against epsilon, not identical temperatures. You may be surprised to finally see which data are affected by the free gas thermal treatment.
23. Warn if em0 card has different number of bins than eN card (also cm0, tm0) RCL/JSH

---

<sup>26</sup>J. F. Briesmeister, Ed., "MCNP - A General Monte Carlo N-Particle Transport Code — Version 4B, LA-12625-M (March 1997)

04/14/99.

24. Check if cross section library and XSDIR temperatures are the same. Until now, there has been no warning and if you use anything other than our provided XSDIR files (especially if you just change the data path); you could cause big problems by pushing the temperature field past column 80. (RCL/JSH) 04/12/99
25. Enable different multigroup scattering laws in a single multigroup run. (RCL/KJA) 01/19/99
26. Protect if negative and positive windows add to 0. (MCW) 01/21/00
27. Add white line color. (JSH) 01/04/00
28. Print history numbers when nps > 1.e9 in tally plots (RAF/JSH) 11/30/99
29. Allow blank lines at end of MCTAL file. (JSH) 11/30/99
30. Use nearest integer for xss pointers. (JSH) 10/28/99

#### V. Corrections

##### *\$20 awards for finding errors in MCNP4B*

In the 4 years of MCNP4B only 6 bugs were found that were not in previous versions.

1. In some cases in MCNP4B could give silent wrong answers for near-coincident lattices. \$20 to Lee Montierth (INEEL) XTM:JSH-97-208 (JSH/LLC) 09/17/97
2. Correct a warning error printout, "particle exited weight window mesh ..." Note that this error cannot be reached so that there is no effect upon anything. Nonetheless, \$20 was awarded to Alexandr Malusek ( Nuclear Physics Institute, Prague, Czech Republic) XCI:JSH-97-60 (JSH) 11/12/97
3. Force PVM to free some buffers. \$20 awarded to Dudley A. Raine, III, ORNL (XTM:JSH-97-176) (GWM) 07/07/97.
4. Forced collision with perturbations bug. (GWM/GWM 06/30/99) \$20 bug award to Alexis Schach von Wittenau, LLNL, XCI:JSH-99-66U

In addition, \$20 awards were given to Mike Milgram, AECL, Chalk River, Canada (XTM:JSH-97-20, 1/25/97) and Joe Chiaramonte, Schlumberger, Ridgefield, CT (XTM:JSH-97-21, 1/25/97) for identifying bugs in a preliminary MCNP4B version that were corrected before MCNP4B went to RSICC.

##### *\$4 awards for finding errors that were in MCNP before MCNP4B*

Several bugs found in MCNP4B were from earlier versions before our SQA program. These were:

1. Check for unbalanced parenthesis on input cards. (XTM:JSH-97-127) 5/19/97 \$4 to David Fuehne (LANSCE/LANL)
2. Correct a crash when criticizing generated weight windows. (JSH) 08/15/98 \$4 Lauren Rauber, XNH (XCI:JSH-98-119)
3. Allow uppercase filenames entered as plot commands. (JSH) 03/02/98 \$4 to Andrew Collier,

AEC Pretoria, South Africa XCI:JSH-98-36

4. Allow plots of negative values. (LJC) 04/07/98 \$4 Jacek Arkuzewski, PSI, Switzerland (XCI:JSH-98-57U)
5. Enable SI, SP, SB with user source. XCI:JSH-98-103 (JFB/JSH) 07/03/98 \$4 Jacek Arkuzewski, PSI, Switzerland
6. Expire call kills geometry plot. (\$4 Paul Bradley XNH/JSH) 08/03/99
7. Out of range error causes KCODE crash. \$4 to Alan Wong (JSH) 10/12/99
8. Master-slave detectors fail with PD card. (RAF) 01/05/00 \$4 to Ken Burn, ENEA, Italy (X-5:JSH-00-04)

*Corrections identified by the MCNP staff*

Most MCNP corrections are discovered by our own internal testing before users encounter them.

1. Reformulation of net multiplication in the summary table. (REP X-5:2000-14) 01/26/00
2. Correct roundoff errors for small DXTRAN sphere radii. (RAF/JSH) 07/07/98
3. Move saved variables rnb(5),rr0,ic0,iw0, from acecs6 to task common for multitasking. Remove possible recursive calls. (RAF) 04/15/98
4. Fix common block character variable alignment problems on UNICOS in sharing character strings between C and FORTRAN. (LJC) 04/08/98
5. Correct printout that F8:p is not for neutrons in mode n,p (JFB/JSH) 08/17/98
6. Ensure that the only surface type appearing in a chain of different repeated structures levels are coincident planes. (JSH) 08/17/98
7. Correct the error message, "improper geometry specification detected in unimaz." (JSH) 12/18/97
8. Clean up "Plot plane coincident with surface" warning (JSH) 08/26/98
9. Correct color plotting streaks. (JSH) 08/24/98
10. Correct warning "One or more PVM processes have terminated prematurely." (GWM) 07/07/97
11. Treat forced collision zero weight (which can happen in a pure absorber or capture resonance in some new data libraries) as weight cutoff (REM/JSH) 10/19/98
12. Correct a wrong index which could affect variance reduction and tracking. (GWM) 07/07/97
13. Correct error message (use problem cell number) in error message, "contribution to DXTRAN sphere prevented by zero importance." (JSH) 04/21/98
14. Eliminate a superfluous lab energy check on rest frame energy. (LJC) 03/02/98
15. Correct an incorrect argument for an evaporation spectrum in some data libraries. (No harm since we don't have any data libraries with this particular law.) (JCC) 03/02/98
16. Correct PERT card RXN option for photons (sometimes flags wrong reaction number with mtp.) (JSH) 07/24/98

17. Workaround an SGI multitasking compile bug which requires a save statement (JSH) 08/13/98
18. Prevent a crash if the relative error in a tally fluctuation chart is a true zero (EXS) 06/01/96
19. Correct for the case where a MCTAL file has a code name (kod) starting with f,d,u,s,m,c,e,t or ft,dt,ut,st,mt,ct,et,tt. (SCF/JSH) 04/07/98
20. Correct a postscript color fill bug. (JSH) 01/13/97
21. Work around a Sun compiler error. (JSH) 05/15/98
22. Time tallies wrong for two consecutive segment tallies RAF 03/09/99. Affects you only if you have both segment and time bins for the same tally. Has been wrong forever.
23. Correct reading of ra(nr) where ra is dimensioned 15 and nr = 16 for cylindrical meshes. JSH 03/17/99 Affects you only if you were using Justine or AVATAR.
24. "perturbation disabled due to lack of tallies" no longer applies to KCODE problems. Spurious error message only affects intermediate MCNP4C version MCNP4XS.
25. A harmless index error (because next isotope at this point is always 0) at (do 395 in oldcrd) corrected. (MCW) 10/13/98
26. tallyd:

```
do 620 idet=i+1,i+ndet(ipt)
do 30 i=3,8
```

changed i to m1 in do 620. Harmless on all compilers we know.
27. MCNPLOT "free" command does not work with Sun Solaris Change ibin to fdusmct&. Affects intermediate version MCNP4XS only. (Kent Parsons XCI/LJC) 4/19/99
28. KCODE PERT with METHOD < 0 fails because sump accumulated during inactive cycles. 4/29/99. Affects intermediate version MCNP4XS only.
29. New SGI compiler fails on write(ius)947830, ... use write(ius)k (JSH/LJC) 12/10/98
30. Correct setenv DATAPATH utilization initialization (JSH) 11/20/98
31. KCODE printed negative history numbers (JSH) 12/16/98
32. Eliminate the spurious error message
33. Initialize je prior to call to knorm. (RDM) 12/15/99 "dxtran weight cutoffs needed with analog capture." when it erroneously occurs without analog capture.
34. Do not play the weight cutoff game in meshes with a zero weight window except at collisions (MCNP4B did it at 1 mfp weight window checks as well as collisions but not at surfaces.) (JSH) 09/02/99
35. 1./sqrt(float(n)) needs to be one/sqrt(float(n)) for character type. ACALC (Bernardette Kirk, ORNL) 9/13/99
36. alpha time absorption in a void comes out as DXTRAN loss (HISTORY, label 187 should be nter=16) (RAF) 09/24/99
37. Eliminate superfluous variables. (JAF) 11/05/99
38. Correct crashing tally plots when reading MCTAL files. (JDC/JSH) 11/30/99

39. Correct spelling in several places. (JAF) 11/10/99
40. Correct more color plotting streaks. (JSH) 10/13/99
41. Allow interrupt for DEC on PC's. (JTG/JSH) 09/15/99

*Weight Window Generator Corrections and Enhancements:*

1. Exponential transform now works with mesh windows.
2. Limit the weight cutoff game in zero-window cells to 1-for-2 roulette.
3. Analog capture is default for surface-only window.
4. For cell-based windows, do DXTRAN weight cutoff game when other windows are done — after collision, source, etc. Note that weight window roulette is not done where weight cutoff is done because emerging particles may be in different window energy bins.
5. For forced collisions with surface-only windows or zero windows at collisions, do not play weight cutoff game (DXTRAN or cell importance) for collided particles, but do not force additional collisions.
6. Turn off importance splitting/roulette if the weight window is turned on.
7. Corrected long-term MCNP4B-AVATAR / forced collision bug.
8. No longer need 2nd argument, call wtwndo(mm,ww)
9. Correct misreading of cell-based windows from WWINP file.
10. Weight window game is now played straight out of source; previously, it was not played for surface-only windows from the source.

VI. Acknowledgements

We wish to thank the Department of Energy Nuclear Criticality Safety Program for funding much of MCNP4C.

MCNP4C was developed by the Monte Carlo Team in the Diagnostic Applications Group (X-5) of the Applied Physics Division (X) at Los Alamos National Laboratory. It is the work of many people who are now listed along with their initials to identify their contributions in the above text.

*X-5 Monte Carlo Team:* Ken Adams (KJA), Tom Booth (TEB), Judi Briesmeister (JFB), Larry Cox (LJC), Jeff Favorite (JAF), Art Forster (RAF), John Hendricks (JSH), Gregg McKinney (GWM)(Team Leader), Russ Mosteller (RDM), Dick Prael (REP), Chris Werner (CJW) *Consultants and Contractors:* Lee Carter (LLC), Gregg Giesler (GCG), Bill Hamilton (WBH), Elizabeth Selcow (ECS); Ed Snow (EXS) *Students:* Christopher Culbertson (CNC), Tim Goorley (JTG), Andrew Hess (AKH),

*Others:* Jack Comly (JCC, X-5), Dave Court (JDC, X-5), Bob Little (RCL, X-5), Morgan White (MCW, X-5), Tom Evans (TME, X-6), H. Grady Hughes (HGH, X-6), Bob MacFarlane (REM, T-2)

Appendix A  
New KCODE Card Entries

<u>Entry</u>	<u>Default</u>	<u>Description</u>
NSRCK	1000	number of source histories per cycle
RKK	1.	initial guess of $k_{eff}$
IKZ	30	number of cycles to be skipped before beginning
KCT	IKZ + 100	number of cycles to be done
MSRK	4500,2*NSRCK	number of points to allocate storage for
KNRM	0	normalize tallies by 0=weight/1=histories
MRKP	6500	maximum number of cycles allowed on MCTAL or RUNTPE
KC8	1	summary, tally information for 1=active/0=all histories
ALPHA	none	imposed value of alpha (gen/shake)

Note that the new ALPHA parameter has been added and now there are defaults for all entries.

New ACODE Card Entries

<u>Entry</u>	<u>Default</u>	<u>Description</u>
NSRCK	1000	number of source histories per cycle
RKK	1.	initial guess of $k_{eff}$
IKZ	30	number of cycles to be skipped before beginning
KCT	IKZ + 100	number of cycles to be done
MSRK	4500,2*NSRCK	number of points to allocate storage for
KNRM	0	normalize tallies by 0=weight/1=histories
KALPHA	1	Alpha estimator: 1/2/3 = col/abs/trk 4 = differential operator perturbation estimator
KALSAV	automatic	cycle to start averaging alphas
KALREG	KALSAV+2	cycle to start ln-ln regression and reduce number of internal settle cycles
MRKP	6500	maximum number of cycles allowed on MCTAL or RUNTPE
ALPHA	0	initial guess of alpha (gen/shake)
ALMIN	0	minimum floor value of alpha

Appendix B  
Macrobody Comparison

MCNP4B hex. in hex

1 100 .01 -11 12 -13 14 -15 16 -17 18  
2 200 .01 -21 22 -23 24 -25 26 -27 28  
(11:-12:13:-14:15:-16:17:-18)  
3 0 21:-22:23:-24:25:-26:27:-28

11 py 2.  
12 py -2.  
13 p -8.6602540E-01 .5 0. 2.  
14 p -8.6602540E-01 .5 0. -2.  
15 p -8.6602540E-01 -.5 0. 2.  
16 p -8.6602540E-01 -.5 0. -2.  
17 pz 4.  
18 pz -4.  
21 py 3.  
22 py -3.  
23 p -8.6602540E-01 .5 0. 3.  
24 p -8.6602540E-01 .5 0. -3.  
25 p -8.6602540E-01 -.5 0. 3.  
26 p -8.6602540E-01 -.5 0. -3.  
27 pz 5.  
28 pz -5.

In MCNP4C with macrobodies, this simply becomes:

MCNP4C hex in hex

1 100 .01 -10  
2 200 .01 10 -20  
3 0 20  
  
10 rhp 0 0 -4 0 0 8 0 2 0  
20 rhp 0 0 -5 0 0 10 0 3 0



Appendix C  
Macrobody Specifications

BOX: Arbitrarily oriented orthogonal box (all corners 90-degrees). The specification is:

BOX Vx Vy Vz A1x A1y A1z A2x A2y A2z A3x A3y A3z

where Vx Vy Vz = x,y,z coordinates of corner;  
A1x A1y A1z = vector of 1st side;  
A2x A2y A2z = vector of 2nd side;  
A3x A3y A3z = vector of 3rd side.

For example, BOX -1 -1 -1 2 0 0 0 2 0 0 0 2  
is a cube centered at the origin, 2cm on a side, with  
sides normal to the major axes.

RPP: Rectangular Parallelepiped, a box with surfaces normal to the major axes. The specification is:

RPP Xmin Xmax Ymin Ymax Zmin Zmax

For example, RPP -1 1 -1 1 -1 1  
is the above BOX cube centered at the origin, 2cm on a side, with  
sides normal to the major axes.

SPH: Sphere. The specification is the same as the MCNP general sphere at x,y,z = Vx Vy Vz and with radius = R:

SPH Vx Vy Vz R

RCC: Right Circular Cylinder; a can with base centered at Vx Vy Vz and a cylindrical axis vector Hx Hy Hz and radius R.

RCC Vx Vy Vz Hx Hy Hz R

For example, RCC 0 -5 0 0 10 0 4  
is a can on the y-axis, centered at the origin, 10 cm high,  
with a 4 cm radius.

RHP or HEX: Right Hexagonal Prism. The RHP does not exactly follow the Integrated Tiger Series (ACCEPT) format.

RHP v1 v2 v3 h1 h2 h3 r1 r2 r3 s1 s2 s3 t1 t2 t3

where: v1 v2 v3 are the x,y,z coordinates of the bottom of the hex;  
h1 h2 h3 is the vector from the bottom to the top:

To Distribution  
X-5-JSH-2000-30 (U)

-15-

29 February 2000

a z-hex with height h would be 0 0 h  
a y-hex with height h would be 0 h 0  
r1 r2 r3 is the vector from the axis to the middle of the  
first facet: for pitch 2p facet normal to y-axis,  
r1,r2,r3 = 0 p 0  
s1 s2 s3 is the vector to the center of the 2nd facet  
t1 t2 t3 is the vector to the center of the 3rd facet

Appendix D  
Macrobody Facet Specifications

Facets are sequentially numbered as follows:

BOX	1	Plane normal to end of A1x A1y A1z
	2	Plane normal to beginning of A1x A1y A1z
	3	Plane normal to end of A2x A2y A2z
	4	Plane normal to beginning of A2x A2y A2z
	5	Plane normal to end of A3x A3y A3z
	6	Plane normal to beginning of A3x A3y A3z
RPP	1	Plane Xmax
	2	Plane Xmin
	3	Plane Ymax
	4	Plane Ymin
	5	Plane Zmax
	6	Plane Zmin
SPH	Treated as a regular surface so no facet	
RCC	1	Cylindrical surface of radius R
	2	Plane normal to end of Hx Hy Hz
	3	Plane normal to beginning of Hx Hy Hz
RHP	1	Plane normal to end of r1 r2 r3
	2	Plane normal to beginning of r1 r2 r3
	3	Plane normal to end of s1 s2 s3
	4	Plane normal to beginning of s1 s2 s3
	5	Plane normal to end of t1 t2 t3
	6	Plane normal to beginning of t1 t2 t3
	7	Plane normal to the end of h1 h2 h3
	8	Plane normal to beginning of h1 h2 h3

Note: the facets are numbered as body number followed by a ".#" and may be viewed in the geometry plotter with the new MBODY=off command. For example, the second facet of RHP surface 9 is surface 9.2.

Note: The BOX or RPP may be infinite in a dimension, in which case those two facets are skipped and the numbers of the remaining facets are decreased by two.

To Distribution  
X-5:JSH-2000-30 (U)

-17-

29 February 2000

JSH:jsh

Distribution:

X-5 File

A. R. Heath, X-5, MS F663  
T. J. Seed, X-5, MS F663  
G. W. McKinney, X-5, MS F663  
K. J. Adams, X-5, MS F663  
T. E. Booth, X-5, MS F663  
J. F. Briesmeister, X-5, MS F663  
L. L. Carter, X-5, MS F663  
L. J. Cox, X-5, MS F663  
J. D. Court, X-5, MS F663  
G. P. Estes, X-5, MS F663  
J. A. Favorite, X-5, MS F663  
S. C. Frankle, X-5, MS F663  
R. A. Forster, X-5, MS F663  
W. B. Hamilton, X-5, MS F663  
J. S. Hendricks, X-5, MS F663  
C. F. Lebeda, X-5, MS F663  
R. C. Little, X-5, MS F663  
R. D. Mosteller, X-5, MS F663  
R. E. Prael, X-5, MS F663  
C. E. Ragan, X-5, MS F663  
L. A. Rauber, X-5, MS F663  
R. R. Roberts, X-5, MS F663  
E. C. Selcow, X-5, MS F663  
C. J. Werner, X-5, MS F663  
M. C. White, X-5, MS F663  
H. G. Hughes, X-6, MS D409  
H. Lichtenstein, X-6, MS D409  
G. C. Giesler, CIC-12, MS B295  
R. E. MacFarlane, T-2, MS B243

**S  
E  
C  
T  
I  
O  
N  
  
4**

LA-13709-M  
Manual

UC abc  
and  
UC 700

Issued: March 2000

# MCNP<sup>TM</sup>—A General Monte Carlo N-Particle Transport Code

Version 4C

Judith F. Briesmeister, Editor

An Affirmative Action/Equal Opportunity Employer

DISCLAIMER

This report was prepared as an account of work sponsored by an agency of the United States Government. Neither the United States Government nor any agency thereof, nor any of their employees, makes any warranty, express or implied, or assumes any legal liability or responsibility for the accuracy, completeness, or usefulness of any information, apparatus, product, or process disclosed, or represents that its use would not infringe privately owned rights. Reference herein to any specific commercial product, process, or service by trade name, trademark, manufacturer, or otherwise, does not necessarily constitute or imply its endorsement, recommendation, or favoring by the United States Government or any agency thereof. The views and opinions of authors expressed herein do not necessarily state or reflect those of the United States government or any agency thereof.

## FOREWORD

*This manual is a practical guide for the use of our general-purpose Monte Carlo code MCNP. The first chapter is a primer for the novice user. The second chapter describes the mathematics, data, physics, and Monte Carlo simulation found in MCNP. This discussion is not meant to be exhaustive---details of the particular techniques and of the Monte Carlo method itself will have to be found elsewhere. The third chapter shows the user how to prepare input for the code. The fourth chapter contains several examples, and the fifth chapter explains the output. The appendices show how to use MCNP on various computer systems and also give details about some of the code internals.*

*The Monte Carlo method emerged from work done at Los Alamos during World War II. The invention is generally attributed to Fermi, von Neumann, Ulam, Metropolis, and Richtmyer. MCNP is the successor to their work and represents over 450 person-years of development.*

*Neither the code nor the manual is static. The code is changed as the need arises and the manual is changed to reflect the latest version of the code. This particular manual refers to Version 4C.*

*MCNP and this manual are the product of the combined effort of many people in the Diagnostics Applications Group (X-5) in the Applied Physics Division (X Division) at the Los Alamos National Laboratory.*

*The code and manual can be obtained from the Radiation Safety Information Computational Center (RSICC), P. O. Box 2008, Oak Ridge, TN, 37831-6362*

J. F. Briesmeister  
Editor  
505-667-7277  
email: mcnp@lanl.gov



## COPYRIGHT NOTICE FOR MCNP VERSION 4C

Unless otherwise indicated, this information has been authored by an employee or employees of the University of California, operator of the Los Alamos National Laboratory under Contract No. W-7405-ENG-36 with the U.S. Department of Energy. The U.S. Government has rights to use, reproduce, and distribute this information. The public may copy and use this information without charge, provided that this Notice and any statement of authorship are reproduced on all copies. Neither the government nor the University makes any warranty, express or implied, or assumes any liability or responsibility for the use of this information.

## TABLE OF CONTENTS

CHAPTER 1	1
I.  MCNP AND THE MONTE CARLO METHOD	1
A.  Monte Carlo Method vs Deterministic Method	2
B.  The Monte Carlo Method	3
II.  INTRODUCTION TO MCNP FEATURES	4
A.  Nuclear Data and Reactions	4
B.  Source Specification	5
C.  Tallies and Output	6
D.  Estimation of Monte Carlo Errors	7
E.  Variance Reduction	9
III.  MCNP GEOMETRY	13
A.  Cells	14
B.  Surface Type Specification	19
C.  Surface Parameter Specification	19
IV.  MCNP INPUT FOR SAMPLE PROBLEM	20
A.  INP File	22
B.  Cell Cards	23
C.  Surface Cards	24
D.  Data Cards	25
V.  HOW TO RUN MCNP	31
A.  Execution Line	32
B.  Interrupts	35
C.  Running MCNP	35
VI.  TIPS FOR CORRECT AND EFFICIENT PROBLEMS	36
A.  Problem Setup	36
B.  Preproduction	36
C.  Production	37
VII.  REFERENCES	38
CHAPTER 2	1
I.  INTRODUCTION	1
A.  History	2
B.  MCNP Structure	5
C.  History Flow	7
II.  GEOMETRY	9
A.  Complement Operator	9
B.  Repeated Structure Geometry	11

	C. Surfaces.....	11
III.	CROSS SECTIONS .....	16
	A. Neutron Interaction Data: Continuous-Energy and Discrete-Reaction .....	18
	B. Photon Interaction Data .....	21
	C. Electron Interaction Data .....	23
	D. Neutron Dosimetry Cross Sections.....	23
	E. Neutron Thermal S( $\alpha,\beta$ ) Tables.....	24
	F. Multigroup Tables.....	25
IV.	PHYSICS .....	25
	A. Particle Weight .....	26
	B. Particle Tracks .....	27
	C. Neutron Interactions .....	27
	D. Photon Interactions .....	55
	E. Electron Interactions.....	63
V.	TALLIES .....	76
	A. Surface Current Tally .....	78
	B. Flux Tallies .....	78
	C. Track Length Cell Energy Deposition Tallies .....	80
	D. Pulse Height Tallies .....	83
	E. Flux at a Detector .....	85
	F. Additional Tally Features .....	95
VI.	ESTIMATION OF THE MONTE CARLO PRECISION .....	99
	A. Monte Carlo Means, Variances, and Standard Deviations.....	99
	B. Precision and Accuracy.....	101
	C. The Central Limit Theorem and Monte Carlo Confidence Intervals .....	103
	D. Estimated Relative Errors in MCNP.....	104
	E. MCNP Figure of Merit .....	108
	F. Separation of Relative Error into Two Components.....	109
	G. Variance of the Variance .....	111
	H. Empirical History Score Probability Density Function f(x).....	113
	I. Forming Statistically Valid Confidence Intervals.....	119
	J. A Statistically Pathological Output Example .....	123
VII.	VARIANCE REDUCTION .....	127
	A. General Considerations.....	127
	B. Variance Reduction Techniques.....	132
VIII.	CRITICALITY CALCULATIONS .....	159
	A. Criticality Program Flow .....	159
	B. Estimation of $k_{\text{eff}}$ Confidence Intervals and Prompt Neutron Lifetimes ...	162
	C. Recommendations for Making a Good Criticality Calculation .....	178
IX.	VOLUMES AND AREAS <sup>114</sup> .....	181
	A. Rotationally Symmetric Volumes and Areas .....	181
	B. Polyhedron Volumes and Areas .....	182

	C.	Stochastic Volume and Area Calculation . . . . .	183
X.		PLOTTER . . . . .	183
XI.		PSEUDORANDOM NUMBERS . . . . .	187
XII.		PERTURBATIONS . . . . .	188
	A.	Derivation of the Operator . . . . .	189
	B.	Limitations . . . . .	195
	C.	Accuracy . . . . .	196
XIII.		REFERENCES . . . . .	197
CHAPTER 3 . . . . .			1
I.		INP FILE . . . . .	1
	A.	Message Block . . . . .	1
	B.	Initiate-Run . . . . .	2
	C.	Continue-Run . . . . .	2
	D.	Card Format . . . . .	4
	E.	Particle Designators . . . . .	7
	F.	Default Values . . . . .	8
	G.	Input Error Messages . . . . .	8
	H.	Geometry Errors . . . . .	8
II.		CELL CARDS . . . . .	10
	A.	Shorthand Cell Specification . . . . .	12
III.		SURFACE CARDS . . . . .	12
	A.	Surfaces Defined by Equations . . . . .	12
	B.	Axisymmetric Surfaces Defined by Points . . . . .	16
	C.	General Plane Defined by Three Points . . . . .	19
	D.	Surfaces Defined by Macrobodyes . . . . .	19
IV.		DATA CARDS . . . . .	22
	A.	Problem Type (MODE) Card . . . . .	23
	B.	Geometry Cards . . . . .	23
	C.	Variance Reduction . . . . .	32
	D.	Source Specification . . . . .	49
	E.	Tally Specification . . . . .	73
	F.	Material Specification Cards . . . . .	107
	G.	Energy and Thermal Treatment Specification . . . . .	116
	H.	Problem Cutoff Cards . . . . .	123
	I.	User Data Arrays . . . . .	126
	J.	Peripheral Cards . . . . .	127
V.		SUMMARY OF MCNP INPUT FILE . . . . .	146
	A.	Input Cards . . . . .	146
	B.	Storage Limitations . . . . .	150

CHAPTER 4 .....	1
I.    GEOMETRY SPECIFICATION .....	1
II.   COORDINATE TRANSFORMATIONS .....	15
A.  TR1 and $M = 1$ Case: .....	18
B.  TR2 and $M = -1$ Case: .....	19
III.  REPEATED STRUCTURE AND LATTICE EXAMPLES .....	20
IV.   TALLY EXAMPLES .....	37
A.  FMn Examples (Simple Form) .....	37
B.  FMn Examples (General Form) .....	39
C.  FSn Examples .....	40
D.  FTn Examples .....	42
E.  Repeated Structure/Lattice Tally Example .....	44
F.  TALLYX Subroutine Examples .....	47
V.    SOURCE EXAMPLES .....	50
VI.   SOURCE SUBROUTINE .....	53
VII.  SRCDX SUBROUTINE .....	55
 CHAPTER 5 .....	 1
I.    DEMO PROBLEM AND OUTPUT .....	1
II.   TEST1 PROBLEM AND OUTPUT .....	9
III.  CONC PROBLEM AND OUTPUT .....	48
IV.   KCODE .....	61
V.    EVENT LOG AND GEOMETRY ERRORS .....	99
A.  Event Log .....	99
B.  Debug Print .....	102
 APPENDIX B .....	 1
I.    SYSTEM GRAPHICS INFORMATION .....	1
A.  X-Windows .....	2
II.   THE PLOT GEOMETRY PLOTTER .....	3
A.  PLOT Input and Execute Line Options .....	3
B.  Plot Commands Grouped by Function .....	5
C.  Geometry Debugging and Plot Orientation .....	9
III.  THE MCPLOT TALLY AND CROSS SECTION PLOTTER .....	10
A.  Input for MCPLOT and Execution Line Options .....	11
B.  Plot Conventions and Command Syntax .....	12
C.  Plot Commands Grouped by Function .....	13
D.  MCTAL Files .....	20
E.  Example of Use of COPLOT .....	22
 APPENDIX C .....	 1
I.    INSTALLING MCNP .....	1

A.	On Supported Systems .....	2
B.	VMS System .....	4
C.	On Other Systems .....	5
II.	MODIFYING MCNP .....	8
A.	Creating a PRPR Patch File .....	8
B.	Creating a New MCNP Executable .....	11
III.	MCNP VERIFICATION .....	12
A.	On Supported Systems .....	12
B.	On VMS System .....	13
IV.	CONVERTING CROSS-SECTION FILES WITH MAKXSF .....	14
APPENDIX D. ....		1
I.	PREPROCESSORS .....	1
II.	PROGRAMMING LANGUAGE .....	1
III.	SYMBOLIC NAMES .....	2
IV.	SYSTEM DEPENDENCE .....	3
V.	COMMON BLOCKS .....	4
VI.	DYNAMICALLY ALLOCATED STORAGE .....	5
VII.	THE RUNTPE FILE .....	6
VIII.	C FUNCTIONS .....	7
IX.	REFERENCES .....	7
APPENDIX E. ....		1
I.	DICTIONARY OF SYMBOLIC NAMES .....	1
II.	SOME IMPORTANT COMPLICATED ARRAYS .....	32
A.	Source Arrays .....	32
B.	Transport Arrays .....	33
C.	Tally Arrays .....	35
D.	Accounting Arrays .....	41
E.	KCODE Arrays .....	46
F.	Alpha Arrays .....	48
G.	Universe Map/ Lattice Activity Arrays for Table 128 .....	48
H.	Weight Window Mesh Parameters .....	49
I.	Perturbation Parameters .....	49
J.	Macrobody and Identical Surface Arrays .....	51
APPENDIX F. ....		1
I.	Data Types and Classes .....	1
II.	XSDIR— Data Directory File .....	2
III.	Data Tables .....	4
A.	Locating Data on a Type 1 Table .....	5
B.	Locating Data on a Type 2 Table .....	10

C.	Locating Data Tables in MCNP .....	11
D.	Individual Data Blocks .....	11
IV.	Data Blocks for Continuous–Energy and Discrete Neutron Transport Tables. . . .	12
V.	Data Blocks for Dosimetry Tables .....	34
VI.	Data Blocks for Thermal $S(\alpha,\beta)$ Tables .....	35
VII.	Data Blocks for Photon Transport Tables. ....	38
VIII.	Format for Multigroup Transport Tables .....	40
IX.	Format for Electron Transport Tables. ....	52
Appendix G.	.....	1
I.	ENDF/B REACTION TYPES .....	1
II.	$S(a,b)$ DATA FOR USE WITH THE MT <sub>m</sub> CARD .....	5
III.	MCNP NEUTRON CROSS–SECTION LIBRARIES.....	6
IV.	MULTIGROUP DATA FOR MCNP.....	29
V.	DOSIMETRY DATA FOR MCNP .....	32
VI.	REFERENCES .....	46
Appendix H.	.....	1
I.	CONSTANTS FOR FISSION SPECTRA .....	1
A.	Constants for the Maxwell fission spectrum (neutron-induced). ....	1
B.	Constants for the Watt Fission Spectrum .....	3
II.	FIUX-TO-DOSE CONVERSION FACTORS.....	3
A.	Biological Dose Equivalent Rate Factors.....	4
B.	Silicon Displacement Kerma Factors .....	5
III.	REFERENCES .....	7
Appendix I	.....	1
Appendix J	.....	1

MCNP—A General Monte Carlo N—Particle Transport Code  
Version 4C

Diagnostics Applications Group  
Los Alamos National Laboratory

ABSTRACT

MCNP is a general-purpose Monte Carlo N-Particle code that can be used for neutron, photon, electron, or coupled neutron/photon/electron transport, including the capability to calculate eigenvalues for critical systems. The code treats an arbitrary three-dimensional configuration of materials in geometric cells bounded by first- and second-degree surfaces and fourth-degree elliptical tori.

Pointwise cross-section data are used. For neutrons, all reactions given in a particular cross-section evaluation (such as ENDF/B-VI) are accounted for. Thermal neutrons are described by both the free gas and  $S(\alpha,\beta)$  models. For photons, the code takes account of incoherent and coherent scattering, the possibility of fluorescent emission after photoelectric absorption, absorption in pair production with local emission of annihilation radiation, and bremsstrahlung. A continuous-slowing-down model is used for electron transport that includes positrons, k x-rays, and bremsstrahlung but does not include external or self-induced fields.

Important standard features that make MCNP very versatile and easy to use include a powerful general source, criticality source, and surface source; both geometry and output tally plotters; a rich collection of variance reduction techniques; a flexible tally structure; and an extensive collection of cross-section data.



CHAPTER 2  
INP File

*NOTES:*

## **CHAPTER 1**

### **PRIMER**

#### **WHAT IS COVERED IN CHAPTER 1**

- Brief explanation of the Monte Carlo method.
- Summary of MCNP features.
- Introduction to geometry.
- Description of MCNP data input illustrated by a sample problem.
- How to run MCNP.
- Tips on problem setup.

Chapter 1 will enable the novice to start using MCNP, assuming very little knowledge of the Monte Carlo method and no experience with MCNP. The primer begins with a short discussion of the Monte Carlo method. Five features of MCNP are introduced: (1) nuclear data and reactions, (2) source specifications, (3) tallies and output, (4) estimation of errors, and (5) variance reduction. The third section explains MCNP geometry setup, including the concept of cells and surfaces. A general description of an input deck is followed by a sample problem and a detailed description of the input cards used in the sample problem. Section V tells how to run MCNP, VI lists tips for setting up correct problems and running them efficiently, and VII is the references for Chapter 1. The word “card” is used throughout this document to describe a single line of input up to 80 characters.

#### ***I. MCNP AND THE MONTE CARLO METHOD***

MCNP is a general-purpose, continuous-energy, generalized-geometry, time-dependent, coupled neutron/photon/electron Monte Carlo transport code. It can be used in several transport modes: neutron only, photon only, electron only, combined neutron/photon transport where the photons are produced by neutron interactions, neutron/photon/electron, photon/electron, or electron/photon. The neutron energy regime is from  $10^{-11}$  MeV to 20 MeV, and the photon and electron energy regimes are from 1 keV to 1000 MeV. The capability to calculate keff eigenvalues for fissile systems is also a standard feature.

The user creates an input file that is subsequently read by MCNP. This file contains information about the problem in areas such as:

- the geometry specification,
- the description of materials and selection of cross-section evaluations, the location and characteristics of the neutron, photon, or electron source,
- the type of answers or tallies desired, and
- any variance reduction techniques used to improve efficiency.

## CHAPTER 1

### MCNP AND THE MONTE CARLO METHOD

Each area will be discussed in the primer by use of a sample problem. Remember five “rules” when running a Monte Carlo calculation. They will be more meaningful as you read this manual and gain experience with MCNP, but no matter how sophisticated a user you may become, never forget the following five points:

1. Define and sample the geometry and source well;
2. You cannot recover lost information;
3. Question the stability and reliability of results;
4. Be conservative and cautious with variance reduction biasing; and
5. The number of histories run is not indicative of the quality of the answer.

The following sections compare Monte Carlo and deterministic methods and provide a simple description of the Monte Carlo method.

#### A. *Monte Carlo Method vs Deterministic Method*

Monte Carlo methods are very different from deterministic transport methods. Deterministic methods, the most common of which is the discrete ordinates method, solve the transport equation for the average particle behavior. By contrast, Monte Carlo does not solve an explicit equation, but rather obtains answers by simulating individual particles and recording some aspects (tallies) of their average behavior. The average behavior of particles in the physical system is then inferred (using the central limit theorem) from the average behavior of the simulated particles. Not only are Monte Carlo and deterministic methods very different ways of solving a problem, even what constitutes a solution is different. Deterministic methods typically give fairly complete information (for example, flux) throughout the phase space of the problem. Monte Carlo supplies information only about specific tallies requested by the user.

When Monte Carlo and discrete ordinates methods are compared, it is often said that Monte Carlo solves the integral transport equation, whereas discrete ordinates solves the integro-differential transport equation. Two things are misleading about this statement. First, the integral and integro-differential transport equations are two different forms of the same equation; if one is solved, the other is solved. Second, Monte Carlo “solves” a transport problem by simulating particle histories rather than by solving an equation. No transport equation need ever be written to solve a transport problem by Monte Carlo. Nonetheless, one can derive an equation that describes the probability density of particles in phase space; this equation turns out to be the same as the integral transport equation.

Without deriving the integral transport equation, it is instructive to investigate why the discrete ordinates method is associated with the integro-differential equation and Monte Carlo with the integral equation. The discrete ordinates method visualizes the phase space to be divided into many small boxes, and the particles move from one box to another. In the limit as the boxes get

progressively smaller, particles moving from box to box take a differential amount of time to move a differential distance in space. In the limit this approaches the integro-differential transport equation, which has derivatives in space and time. By contrast, Monte Carlo transports particles between events (for example, collisions) that are separated in space and time. Neither differential space nor time are inherent parameters of Monte Carlo transport. The integral equation does not have time or space derivatives.

Monte Carlo is well suited to solving complicated three-dimensional, time-dependent problems. Because the Monte Carlo method does not use phase space boxes, there are no averaging approximations required in space, energy, and time. This is especially important in allowing detailed representation of all aspects of physical data.

***B. The Monte Carlo Method***

Monte Carlo can be used to duplicate theoretically a statistical process (such as the interaction of nuclear particles with materials) and is particularly useful for complex problems that cannot be modeled by computer codes that use deterministic methods. The individual probabilistic events that comprise a process are simulated sequentially. The probability distributions governing these events are statistically sampled to describe the total phenomenon. In general, the simulation is performed on a digital computer because the number of trials necessary to adequately describe the phenomenon is usually quite large. The statistical sampling process is based on the selection of random numbers—analogue to throwing dice in a gambling casino—hence the name “Monte Carlo.” In particle transport, the Monte Carlo technique is pre-eminently realistic (a theoretical experiment). It consists of actually following each of many particles from a source throughout its life to its death in some terminal category (absorption, escape, etc.). Probability distributions are randomly sampled using transport data to determine the outcome at each step of its life.

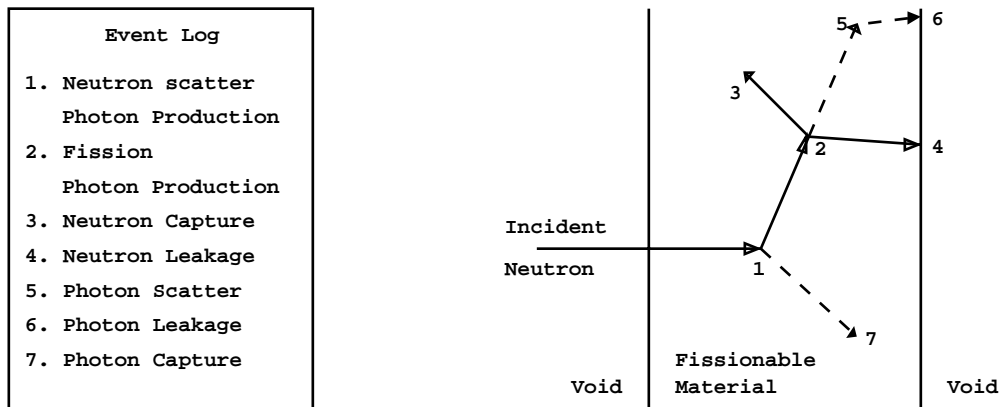

**Figure 1-1.**

## CHAPTER 1

### INTRODUCTION TO MCNP FEATURES

Figure 1.1 represents the random history of a neutron incident on a slab of material that can undergo fission. Numbers between 0 and 1 are selected randomly to determine what (if any) and where interaction takes place, based on the rules (physics) and probabilities (transport data) governing the processes and materials involved. In this particular example, a neutron collision occurs at event 1. The neutron is scattered in the direction shown, which is selected randomly from the physical scattering distribution. A photon is also produced and is temporarily stored, or banked, for later analysis. At event 2, fission occurs, resulting in the termination of the incoming neutron and the birth of two outgoing neutrons and one photon. One neutron and the photon are banked for later analysis. The first fission neutron is captured at event 3 and terminated. The banked neutron is now retrieved and, by random sampling, leaks out of the slab at event 4. The fission-produced photon has a collision at event 5 and leaks out at event 6. The remaining photon generated at event 1 is now followed with a capture at event 7. Note that MCNP retrieves banked particles such that the last particle stored in the bank is the first particle taken out.

This neutron history is now complete. As more and more such histories are followed, the neutron and photon distributions become better known. The quantities of interest (whatever the user requests) are tallied, along with estimates of the statistical precision (uncertainty) of the results.

## II. INTRODUCTION TO MCNP FEATURES

Various features, concepts, and capabilities of MCNP are summarized in this section. More detail concerning each topic is available in later chapters or appendices.

### A. Nuclear Data and Reactions

MCNP uses continuous-energy nuclear and atomic data libraries. The primary sources of nuclear data are evaluations from the Evaluated Nuclear Data File (ENDF)<sup>1</sup> system, the Evaluated Nuclear Data Library (ENDL)<sup>2</sup> and the Activation Library (ACTL)<sup>3</sup> compilations from Livermore, and evaluations from the Applied Nuclear Science (T-2) Group<sup>4,5,6</sup> at Los Alamos. Evaluated data are processed into a format appropriate for MCNP by codes such as NJOY.<sup>7</sup> The processed nuclear data libraries retain as much detail from the original evaluations as is feasible to faithfully reproduce the evaluator's intent.

Nuclear data tables exist for neutron interactions, neutron-induced photons, photon interactions, neutron dosimetry or activation, and thermal particle scattering  $S(\alpha, \beta)$ . Photon and electron data are atomic rather than nuclear in nature. Each data table available to MCNP is listed on a directory file, XSDIR. Users may select specific data tables through unique identifiers for each table, called ZAIDs. These identifiers generally contain the atomic number Z, mass number A, and library specifier ID.

Over 500 neutron interaction tables are available for approximately 100 different isotopes and elements. Multiple tables for a single isotope are provided primarily because data have been derived from different evaluations, but also because of different temperature regimes and different processing tolerances. More neutron interaction tables are constantly being added as new and revised evaluations become available. Neutron-induced photon production data are given as part of the neutron interaction tables when such data are included in the evaluations.

Photon interaction tables exist for all elements from  $Z = 1$  through  $Z = 94$ . The data in the photon interaction tables allow MCNP to account for coherent and incoherent scattering, photoelectric absorption with the possibility of fluorescent emission, and pair production. Scattering angular distributions are modified by atomic form factors and incoherent scattering functions.

Cross sections for nearly 2000 dosimetry or activation reactions involving over 400 target nuclei in ground and excited states are part of the MCNP data package. These cross sections can be used as energy-dependent response functions in MCNP to determine reaction rates but cannot be used as transport cross sections.

Thermal data tables are appropriate for use with the  $S(\alpha,\beta)$  scattering treatment in MCNP. The data include chemical (molecular) binding and crystalline effects that become important as the neutron's energy becomes sufficiently low. Data at various temperatures are available for light and heavy water, beryllium metal, beryllium oxide, benzene, graphite, polyethylene, and zirconium and hydrogen in zirconium hydride.

### ***B. Source Specification***

MCNP's generalized user-input source capability allows the user to specify a wide variety of source conditions without having to make a code modification. Independent probability distributions may be specified for the source variables of energy, time, position, and direction, and for other parameters such as starting cell(s) or surface(s). Information about the geometrical extent of the source can also be given. In addition, source variables may depend on other source variables (for example, energy as a function of angle) thus extending the built-in source capabilities of the code. The user can bias all input distributions.

In addition to input probability distributions for source variables, certain built-in functions are available. These include various analytic functions for fission and fusion energy spectra such as Watt, Maxwellian, and Gaussian spectra; Gaussian for time; and isotropic, cosine, and monodirectional for direction. Biasing may also be accomplished by special built-in functions.

A surface source allows particles crossing a surface in one problem to be used as the source for a subsequent problem. The decoupling of a calculation into several parts allows detailed design or analysis of certain geometrical regions without having to rerun the entire problem from the

## CHAPTER 1

### INTRODUCTION TO MCNP FEATURES

beginning each time. The surface source has a fission volume source option that starts particles from fission sites where they were written in a previous run.

MCNP provides the user three methods to define an initial criticality source to estimate  $k_{eff}$ , the ratio of neutrons produced in successive generations in fissile systems.

#### C. *Tallies and Output*

The user can instruct MCNP to make various tallies related to particle current, particle flux, and energy deposition. MCNP tallies are normalized to be per starting particle except for a few special cases with criticality sources. Currents can be tallied as a function of direction across any set of surfaces, surface segments, or sum of surfaces in the problem. Charge can be tallied for electrons and positrons. Fluxes across any set of surfaces, surface segments, sum of surfaces, and in cells, cell segments, or sum of cells are also available. Similarly, the fluxes at designated detectors (points or rings) are standard tallies. Heating and fission tallies give the energy deposition in specified cells. A pulse height tally provides the energy distribution of pulses created in a detector by radiation. In addition, particles may be flagged when they cross specified surfaces or enter designated cells, and the contributions of these flagged particles to the tallies are listed separately. Tallies such as the number of fissions, the number of absorptions, the total helium production, or any product of the flux times the approximately 100 standard ENDF reactions plus several nonstandard ones may be calculated with any of the MCNP tallies. In fact, any quantity of the form

$$C = \int \phi(E)f(E)dE$$

can be tallied, where  $\phi(\mathbf{E})$  is the energy-dependent fluence, and  $f(\mathbf{E})$  is any product or summation of the quantities in the cross-section libraries or a response function provided by the user. The tallies may also be reduced by line-of-sight attenuation. Tallies may be made for segments of cells and surfaces without having to build the desired segments into the actual problem geometry. All tallies are functions of time and energy as specified by the user and are normalized to be per starting particle.

In addition to the tally information, the output file contains tables of standard summary information to give the user a better idea of how the problem ran. This information can give insight into the physics of the problem and the adequacy of the Monte Carlo simulation. If errors occur during the running of a problem, detailed diagnostic prints for debugging are given. Printed with each tally is also its statistical relative error corresponding to one standard deviation. Following the tally is a detailed analysis to aid in determining confidence in the results. Ten pass/no pass checks are made for the user-selectable tally fluctuation chart (TFC) bin of each tally. The quality of the confidence interval still cannot be guaranteed because portions of the problem phase space possibly still have not been sampled. Tally fluctuation charts, described in the following section, are also

automatically printed to show how a tally mean, error, variance of the variance, and slope of the largest history scores fluctuate as a function of the number of histories run.

Tally results can be displayed graphically, either while the code is running or in a separate postprocessing mode.

***D. Estimation of Monte Carlo Errors***

MCNP tallies are normalized to be per starting particle and are printed in the output accompanied by a second number  $R$ , which is the estimated relative error defined to be one estimated standard deviation of the mean  $S\bar{x}$  divided by the estimated mean  $\bar{x}$ . In MCNP, the quantities required for this error estimate—the tally and its second moment—are computed after each complete Monte Carlo history, which accounts for the fact that the various contributions to a tally from the same history are correlated. For a well-behaved tally,  $R$  will be proportional to  $1/\sqrt{N}$  where  $N$  is the number of histories. Thus, to halve  $R$ , we must increase the total number of histories fourfold. For a poorly behaved tally,  $R$  may increase as the number of histories increases.

The estimated relative error can be used to form confidence intervals about the estimated mean, allowing one to make a statement about what the true result is. The Central Limit Theorem states that as  $N$  approaches infinity there is a 68% chance that the true result will be in the range  $\bar{x}(1 \pm R)$  and a 95% chance in the range  $\bar{x}(1 \pm 2R)$ . *It is extremely important to note that these confidence statements refer only to the precision of the Monte Carlo calculation itself and not to the accuracy of the result compared to the true physical value.* A statement regarding accuracy requires a detailed analysis of the uncertainties in the physical data, modeling, sampling techniques, and approximations, etc., used in a calculation.

The guidelines for interpreting the quality of the confidence interval for various values of  $R$  are listed in Table 1.1.

**TABLE 1.1:**  
**Guidelines for Interpreting the Relative Error  $R^*$**

<u>Range of R</u>	<u>Quality of the Tally</u>
0.5 to 1.0	Not meaningful
0.2 to 0.5	Factor of a few
0.1 to 0.2	Questionable
< 0.10	Generally reliable
< 0.05	Generally reliable for point detectors

$*R = S_{\bar{x}}/\bar{x}$  and represents the estimated relative error at the  $1\sigma$  level. These interpretations of  $R$  assume that all portions of the problem phase space are being sampled well by the Monte Carlo process.



## CHAPTER 1 INTRODUCTION TO MCNP FEATURES

For all tallies except next-event estimators, hereafter referred to as point detector tallies, the quantity  $R$  should be less than 0.10 to produce generally reliable confidence intervals. Point detector results tend to have larger third and fourth moments of the individual tally distributions, so a smaller value of  $R$ ,  $< 0.05$ , is required to produce generally reliable confidence intervals. The estimated uncertainty in the Monte Carlo result must be presented with the tally so that all are aware of the estimated precision of the results.

Keep in mind the footnote to Table 1.1. For example, if an important but highly unlikely particle path in phase space has not been sampled in a problem, the Monte Carlo results will not have the correct expected values and the confidence interval statements may not be correct. The user can guard against this situation by setting up the problem so as not to exclude any regions of phase space and by trying to sample all regions of the problem adequately.

Despite one's best effort, an important path may not be sampled often enough, causing confidence interval statements to be incorrect. To try to inform the user about this behavior, MCNP calculates a figure of merit ( $FOM$ ) for one tally bin of each tally as a function of the number of histories and prints the results in the tally fluctuation charts at the end of the output. The  $FOM$  is defined as

$$FOM \equiv 1/(R^2T)$$

where  $T$  is the computer time in minutes. The more efficient a Monte Carlo calculation is, the larger the  $FOM$  will be because less computer time is required to reach a given value of  $R$ .

The  $FOM$  should be approximately constant as  $N$  increases because  $R^2$  is proportional to  $1/N$  and  $T$  is proportional to  $N$ . *Always examine the tally fluctuation charts to be sure that the tally appears well behaved, as evidenced by a fairly constant  $FOM$ .* A sharp decrease in the  $FOM$  indicates that a seldom-sampled particle path has significantly affected the tally result and relative error estimate. In this case, the confidence intervals may not be correct for the fraction of the time that statistical theory would indicate. Examine the problem to determine what path is causing the large scores and try to redefine the problem to sample that path much more frequently.

After each tally, an analysis is done and additional useful information is printed about the TFC tally bin result. The nonzero scoring efficiency, the zero and nonzero score components of the relative error, the number and magnitude of negative history scores, if any, and the effect on the result if the largest observed history score in the TFC were to occur again on the very next history are given. A table just before the TFCs summarizes the results of these checks for all tallies in the problem. Ten statistical checks are made and summarized in table 160 after each tally, with a pass yes/no criterion. The empirical history score probability density function (PDF) for the TFC bin of each tally is calculated and displayed in printed plots.

The TFCs at the end of the problem include the variance of the variance (an estimate of the error of the relative error), and the slope (the estimated exponent of the PDF large score behavior) as a function of the number of particles started.

All this information provides the user with statistical information to aid in forming valid confidence intervals for Monte Carlo results. There is no GUARANTEE, however. The possibility always exists that some as yet unsampled portion of the problem may change the confidence interval if more histories were calculated. Chapter 2 contains more information about estimation of Monte Carlo precision.

### ***E. Variance Reduction***

As noted in the previous section,  $R$  (the estimated relative error) is proportional to  $1/\sqrt{N}$ , where  $N$  is the number of histories. For a given MCNP run, the computer time  $T$  consumed is proportional to  $N$ . Thus  $R = C/\sqrt{T}$ , where  $C$  is a positive constant. There are two ways to reduce  $R$ : (1) increase  $T$  and/or (2) decrease  $C$ . Computer budgets often limit the utility of the first approach. For example, if it has taken 2 hours to obtain  $R=0.10$ , then 200 hours will be required to obtain  $R=0.01$ . For this reason MCNP has special variance reduction techniques for decreasing  $C$ . (Variance is the square of the standard deviation.) The constant  $C$  depends on the tally choice and/or the sampling choices.

#### **1. Tally Choice**

As an example of the tally choice, note that the fluence in a cell can be estimated either by a collision estimate or a track length estimate. The collision estimate is obtained by tallying  $1/\Sigma_t$  ( $\Sigma_t$ =macroscopic total cross section) at each collision in the cell and the track length estimate is obtained by tallying the distance the particle moves while inside the cell. Note that as  $\Sigma_t$  gets very small, very few particles collide but give enormous tallies when they do, a high variance situation (see page 2-109). In contrast, the track length estimate gets a tally from every particle that enters the cell. For this reason MCNP has track length tallies as standard tallies, whereas the collision tally is not standard in MCNP, except for estimating  $k_{\text{eff}}$ .

#### **2. Nonanalog Monte Carlo**

Explaining how sampling affects  $C$  requires understanding of the nonanalog Monte Carlo model.

The simplest Monte Carlo model for particle transport problems is the analog model that uses the natural probabilities that various events occur (for example, collision, fission, capture, etc.). Particles are followed from event to event by a computer, and the next event is always sampled (using the random number generator) from a number of possible next events according to the natural event probabilities. This is called the analog Monte Carlo model because it is directly analogous to the naturally occurring transport.

## CHAPTER 1

### INTRODUCTION TO MCNP FEATURES

The analog Monte Carlo model works well when a significant fraction of the particles contribute to the tally estimate and can be compared to detecting a significant fraction of the particles in the physical situation. There are many cases for which the fraction of particles detected is very small, less than  $10^{-6}$ . For these problems analog Monte Carlo fails because few, if any, of the particles tally, and the statistical uncertainty in the answer is unacceptable.

Although the analog Monte Carlo model is the simplest conceptual probability model, there are other probability models for particle transport. They estimate the same average value as the analog Monte Carlo model, while often making the variance (uncertainty) of the estimate much smaller than the variance for the analog estimate. Practically, this means that problems that would be impossible to solve in days of computer time can be solved in minutes of computer time.

A nonanalog Monte Carlo model attempts to follow “interesting” particles more often than “uninteresting” ones. An “interesting” particle is one that contributes a large amount to the quantity (or quantities) that needs to be estimated. There are many nonanalog techniques, and they all are meant to increase the odds that a particle scores (contributes). To ensure that the average score is the same in the nonanalog model as in the analog model, the score is modified to remove the effect of biasing (changing) the natural odds. Thus, if a particle is artificially made  $q$  times as likely to execute a given random walk, then the particle’s score is weighted by (multiplied by)  $1/q$ . The average score is thus preserved because the average score is the sum, over all random walks, of the probability of a random walk multiplied by the score resulting from that random walk.

A nonanalog Monte Carlo technique will have the same expected tallies as an analog technique if the expected weight executing any given random walk is preserved. For example, a particle can be split into two identical pieces and the tallies of each piece are weighted by  $1/2$  of what the tallies would have been without the split. Such nonanalog, or variance reduction, techniques can often decrease the relative error by sampling naturally rare events with an unnaturally high frequency and weighting the tallies appropriately.

### 3. Variance Reduction Tools in MCNP

There are four classes of variance reduction techniques<sup>8</sup> that range from the trivial to the esoteric.

**Truncation Methods** are the simplest of variance reduction methods. They speed up calculations by truncating parts of phase space that do not contribute significantly to the solution. The simplest example is geometry truncation in which unimportant parts of the geometry are simply not modeled. Specific truncation methods available in MCNP are energy cutoff and time cutoff.

**Population Control Methods** use particle splitting and Russian roulette to control the number of samples taken in various regions of phase space. In important regions many samples of low weight are tracked, while in unimportant regions few samples of high weight are tracked. A weight adjustment is made to ensure that the problem solution remains unbiased. Specific population

control methods available in MCNP are geometry splitting and Russian roulette, energy splitting/roulette, weight cutoff, and weight windows.

**Modified Sampling Methods** alter the statistical sampling of a problem to increase the number of tallies per particle. For any Monte Carlo event it is possible to sample from any arbitrary distribution rather than the physical probability as long as the particle weights are then adjusted to compensate. Thus, with modified sampling methods, sampling is done from distributions that send particles in desired directions or into other desired regions of phase space such as time or energy, or change the location or type of collisions. Modified sampling methods in MCNP include the exponential transform, implicit capture, forced collisions, source biasing, and neutron-induced photon production biasing.

**Partially-Deterministic Methods** are the most complicated class of variance reduction methods. They circumvent the normal random walk process by using deterministic-like techniques, such as next event estimators, or by controlling the random number sequence. In MCNP these methods include point detectors, DXTRAN, and correlated sampling.

Variance reduction techniques, used correctly, can greatly help the user produce a more efficient calculation. Used poorly, they can result in a wrong answer with good statistics and few clues that anything is amiss. Some variance reduction methods have general application and are not easily misused. Others are more specialized and attempts to use them carry high risk. The use of weight windows tends to be more powerful than the use of importances but typically requires more input data and more insight into the problem. The exponential transform for thick shields is not recommended for the inexperienced user; rather, use many cells with increasing importances (or decreasing weight windows) through the shield. Forced collisions are used to increase the frequency of random walk collisions within optically thin cells but should be used only by an experienced user. The point detector estimator should be used with caution, as should DXTRAN.

For many problems, variance reduction is not just a way to speed up the problem but is absolutely necessary to get any answer at all. Deep penetration problems and pipe detector problems, for example, will run too slowly by factors of trillions without adequate variance reduction. Consequently, users have to become skilled in using the variance reduction techniques in MCNP. Most of the following techniques cannot be used with the pulse height tally.

The following summarizes briefly the main MCNP variance reduction techniques. Detailed discussion is in Chapter 2, page 2–127.

1. **Energy cutoff:** Particles whose energy is out of the range of interest are terminated so that computation time is not spent following them.
2. **Time cutoff:** Like the energy cutoff but based on time.

## CHAPTER 1

### INTRODUCTION TO MCNP FEATURES

3. **Geometry splitting with Russian roulette:** Particles transported from a region of higher importance to a region of lower importance (where they will probably contribute little to the desired problem result) undergo Russian roulette; that is, some of those particles will be killed a certain fraction of the time, but survivors will be counted more by increasing their weight the remaining fraction of the time. In this way, unimportant particles are followed less often, yet the problem solution remains undistorted. On the other hand, if a particle is transported to a region of higher importance (where it will likely contribute to the desired problem result), it may be split into two or more particles (or tracks), each with less weight and therefore counting less. In this way, important particles are followed more often, yet the solution is undistorted because on average total weight is conserved.
4. **Energy splitting/Russian roulette:** Particles can be split or rouletted upon entering various user-supplied energy ranges. Thus important energy ranges can be sampled more frequently by splitting the weight among several particles and less important energy ranges can be sampled less frequently by rouletting particles.
5. **Weight cutoff/Russian roulette:** If a particle weight becomes so low that the particle becomes insignificant, it undergoes Russian roulette. Most particles are killed, and some particles survive with increased weight. The solution is unbiased because total weight is conserved, but computer time is not wasted on insignificant particles.
6. **Weight window:** As a function of energy, geometrical location, or both, low-weighted particles are eliminated by Russian roulette and high-weighted particles are split. This technique helps keep the weight dispersion within reasonable bounds throughout the problem. An importance generator is available that estimates the optimal limits for a weight window.
7. **Exponential transformation:** To transport particles long distances, the distance between collisions in a preferred direction is artificially increased and the weight is correspondingly artificially decreased. Because large weight fluctuations often result, it is highly recommended that the weight window be used with the exponential transform.
8. **Implicit capture:** When a particle collides, there is a probability that it is captured by the nucleus. In analog capture, the particle is killed with that probability. In implicit capture, also known as survival biasing, the particle is never killed by capture; instead, its weight is reduced by the capture probability at each collision. Important particles are permitted to survive by not being lost to capture. On the other hand, if particles are no longer considered useful after undergoing a few collisions, analog capture efficiently gets rid of them.
9. **Forced collisions:** A particle can be forced to undergo a collision each time it enters a designated cell that is almost transparent to it. The particle and its weight are appropriately split into a collided and uncollided part. Forced collisions are often used to generate contributions to point detectors, ring detectors, or DXTRAN spheres.
10. **Source variable biasing:** Source particles with phase space variables of more importance are emitted with a higher frequency but with a compensating lower weight

than are less important source particles. This technique can be used with pulse height tallies.

11. ***Point and ring detectors:*** When the user wishes to tally a flux-related quantity at a point in space, the probability of transporting a particle precisely to that point is vanishingly small. Therefore, pseudoparticles are directed to the point instead. Every time a particle history is born in the source or undergoes a collision, the user may require that a pseudoparticle be tallied at a specified point in space. In this way, many pseudoparticles of low weight reach the detector, which is the point of interest, even though no particle histories could ever reach the detector. For problems with rotational symmetry, the point may be represented by a ring to enhance the efficiency of the calculation.
12. ***DXTRAN:*** DXTRAN, which stands for deterministic transport, improves sampling in the vicinity of detectors or other tallies. It involves deterministically transporting particles on collision to some arbitrary, user-defined sphere in the neighborhood of a tally and then calculating contributions to the tally from these particles. Contributions to the detectors or to the DXTRAN spheres can be controlled as a function of geometric cell or as a function of the relative magnitude of the contribution to the detector or DXTRAN sphere.

The DXTRAN method is a way of obtaining large numbers of particles on user-specified “DXTRAN spheres.” DXTRAN makes it possible to obtain many particles in a small region of interest that would otherwise be difficult to sample. Upon sampling a collision or source density function, DXTRAN estimates the correct weight fraction that should scatter toward, and arrive without collision at, the surface of the sphere. The DXTRAN method then puts this correct weight on the sphere. The source or collision event is sampled in the usual manner, except that the particle is killed if it tries to enter the sphere because all particles entering the sphere have already been accounted for deterministically.

13. ***Correlated sampling:*** The sequence of random numbers in the Monte Carlo process is chosen so that statistical fluctuations in the problem solution will not mask small variations in that solution resulting from slight changes in the problem specification. The  $i^{th}$  history will always start at the same point in the random number sequence no matter what the previous  $i-1$  particles did in their random walks.

### ***III. MCNP GEOMETRY***

We will present here only basic information about geometry setup, surface specification, and cell and surface card input. Areas of further interest would be the complement operator, use of parentheses, and repeated structure and lattice definitions, found in Chapter 2. Chapter 4 contains geometry examples and is recommended as a next step. Chapter 3 has detailed information about the format and entries on cell and surface cards and discusses macrobodies.

## CHAPTER 1 MCNP GEOMETRY

The geometry of MCNP treats an arbitrary three-dimensional configuration of user-defined materials in geometric cells bounded by first- and second-degree surfaces and fourth-degree elliptical tori. The cells are defined by the intersections, unions, and complements of the regions bounded by the surfaces. Surfaces are defined by supplying coefficients to the analytic surface equations or, for certain types of surfaces, known points on the surfaces.

MCNP has a more general geometry than is available in most combinatorial geometry codes. Rather than combining several predefined geometrical bodies, as in a combinatorial geometry scheme, MCNP gives the user the added flexibility of defining geometrical regions from all the first and second degree surfaces of analytical geometry and elliptical tori and then of combining them with Boolean operators. The code does extensive internal checking to find input errors. In addition, the geometry-plotting capability in MCNP helps the user check for geometry errors.

MCNP treats geometric cells in a Cartesian coordinate system. The surface equations recognized by MCNP are listed in Table 3.1 on page 3–14. The particular Cartesian coordinate system used is arbitrary and user defined, but the right-handed system shown in Figure 1.2 is often chosen.

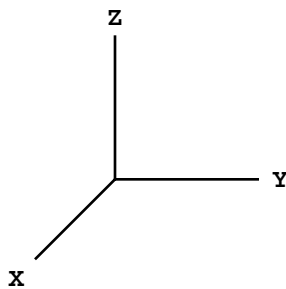

**Figure 1-2.**

Using the bounding surfaces specified on cell cards, MCNP tracks particles through the geometry, calculates the intersection of a track's trajectory with each bounding surface, and finds the minimum positive distance to an intersection. If the distance to the next collision is greater than this minimum distance and there are no DXTRAN spheres along the track, the particle leaves the current cell. At the appropriate surface intersection, MCNP finds the correct cell that the particle will enter by checking the sense of the intersection point for each surface listed for the cell. When a complete match is found, MCNP has found the correct cell on the other side and the transport continues.

### **A. Cells**

When cells are defined, an important concept is that of the *sense* of all points in a cell with respect to a bounding surface. Suppose that  $s = f(x, y, z) = 0$  is the equation of a surface in the

problem. For any set of points  $(x,y,z)$ , if  $s = 0$  the points are on the surface. However, for points not on the surface, if  $s$  is negative, the points are said to have a negative sense with respect to that surface and, conversely, a positive sense if  $s$  is positive. For example, a point at  $x = 3$  has a positive sense with respect to the plane  $x - 2 = 0$ . That is, the equation  $x - D = 3 - 2 = s = 1$  is positive for  $x = 3$  (where  $D = \text{constant}$ ).

Cells are defined on cells cards. Each cell is described by a cell number, material number, and material density followed by a list of operators and signed surfaces that bound the cell. If the sense is positive, the sign can be omitted. The material number and material density can be replaced by a single zero to indicate a void cell. The cell number must begin in columns 1–5. The remaining entries follow, separated by blanks. A more complete description of the cell card format can be found on page 1–23. Each surface divides all space into two regions, one with positive sense with respect to the surface and the other with negative sense. The geometry description defines the cell to be the intersection, union, and/or complement of the listed regions.

The subdivision of the physical space into cells is not necessarily governed only by the different material regions, but may be affected by problems of sampling and variance reduction techniques (such as splitting and Russian roulette), the need to specify an unambiguous geometry, and the tally requirements. The tally segmentation feature may eliminate most of the tally requirements.

Be cautious about making any one cell very complicated. With the union operator and disjointed regions, a very large geometry can be set up with just one cell. The problem is that for each track flight between collisions in a cell, the intersection of the track with each bounding surface of the cell is calculated, a calculation that can be costly if a cell has many surfaces. As an example, consider Figure 1.3a. It is just a lot of parallel cylinders and is easy to set up. However, the cell containing all the little cylinders is bounded by fourteen surfaces (counting a top and bottom). A much more efficient geometry is seen in Figure 1.3b, where the large cell has been broken up into a number of smaller cells.

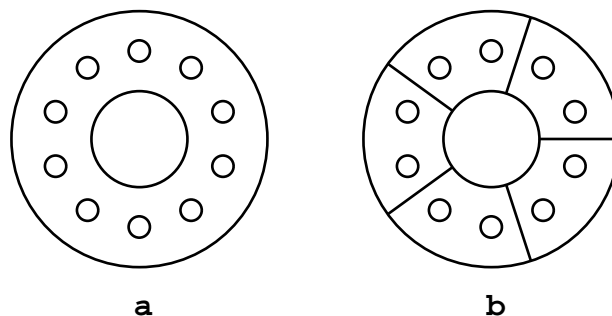

**Figure 1-3.**



# CHAPTER 1

## MCNP GEOMETRY

### 1. Cells Defined by Intersections of Regions of Space

The intersection operator in MCNP is implicit; it is simply the blank space between two surface numbers on the cell card.

If a cell is specified using only intersections, all points in the cell must have the same sense with respect to a given bounding surface. This means that, for each bounding surface of a cell, all points in the cell must remain on only one side of any particular surface. Thus, there can be no concave corners in a cell specified only by intersections. Figure 1.4, a cell formed by the intersection of five surfaces (ignore surface 6 for the time being), illustrates the problem of concave corners by allowing a particle (or point) to be on two sides of a surface in one cell. Surfaces 3 and 4 form a concave corner in the cell such that points  $p_1$  and  $p_2$  are on the same side of surface 4 (that is, have the same sense with respect to 4) but point  $p_3$  is on the other side of surface 4 (opposite sense). Points  $p_2$  and  $p_3$  have the same sense with respect to surface 3, but  $p_1$  has the opposite sense. One way to remedy this dilemma (and there are others) is to add surface 6 between the 3/4 corner and surface 1 to divide the original cell into two cells.

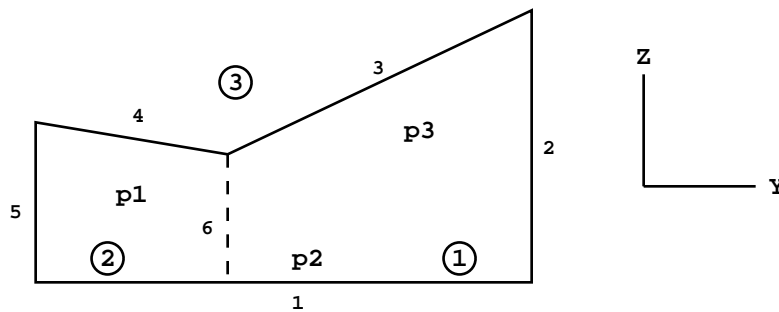

Figure 1-4.

With surface 6 added to Figure 1.4, the cell to the right of surface 6 is number~1 (cells indicated by circled numbers); to the left number 2; and the outside cell number 3. The cell cards (in two dimensions, all cells void) are

```

1 0 1 -2 -3 6
2 0 1 -6 -4 5

```

Cell 1 is a void and is formed by the intersection of the region above (positive sense) surface 1 with the region to the left (negative sense) of surface 2 intersected with the region below (negative sense) surface 3 and finally intersected with the region to the right (positive sense) of surface 6. Cell 2 is described similarly.

Cell 3 cannot be specified with the intersection operator. The following section about the union operator is needed to describe cell 3.

2. Cells Defined by Unions of Regions of Space

The union operator, signified by a colon on the cell cards, allows concave corners in cells and also cells that are completely disjoint. The intersection and union operators are binary Boolean operators, so their use follows Boolean algebra methodology; unions and intersections can be used in combination in any cell description.

Spaces on either side of the union operator are irrelevant, but remember that a space without the colon signifies an intersection. In the hierarchy of operations, intersections are performed first and then unions. There is no left to right ordering. Parentheses can be used to clarify operations and in some cases are required to force a certain order of operations. Innermost parentheses are cleared first. Spaces are optional on either side of a parenthesis. A parenthesis is equivalent to a space and signifies an intersection.

For example, let A and B be two regions of space. The region containing points that belong to both A and B is called the intersection of A and B. The region containing points that belong to A alone or to B alone or to both A and B is called the union of A and B. The lined area in Figure 1.5a represents the union of A and B (or  $A : B$ ), and the lined area in Figure 1.5b represents the intersection of A and B (or  $A B$ ). The only way regions of space can be added is with the union operator. An intersection of two spaces always results in a region no larger than either of the two spaces. Conversely, the union of two spaces always results in a region no smaller than either of the two spaces.

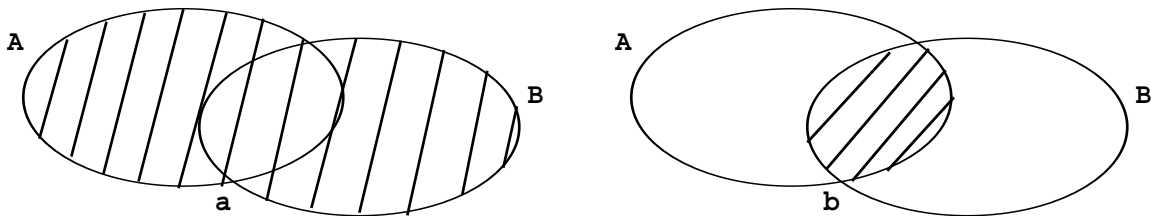

**Figure 1-5.**

A simple example will further illustrate the concept of Figure 1.5 and the union operator to solidify the concept of adding and intersecting regions of space to define a cell. See also the second example in Chapter 4. In Figure 1.6 we have two infinite planes that meet to form two cells. Cell 1 is easy to define; it is everything in the universe to the right of surface 1 (that is, a positive sense) that is also in common with (or intersected with) everything in the universe below surface 2 (that is, a negative sense). Therefore, the surface relation of cell 1 is  $1 -2$ .

**CHAPTER 1**  
**MCNP GEOMETRY**

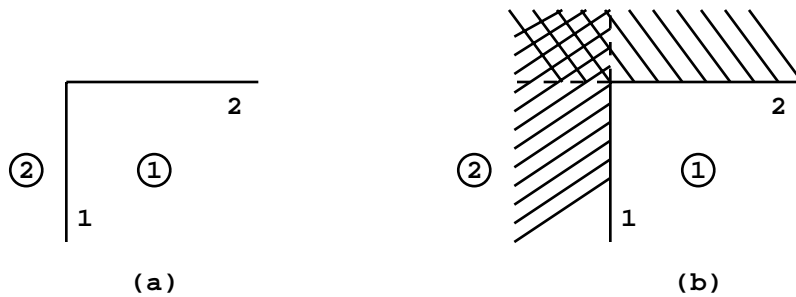

**Figure 1-6.**

Cell 2 is everything in the universe to the left (negative sense) of surface 1 plus everything in the universe above (positive sense) surface 2, or  $-1 : 2$ , illustrated in Figure 1.6b by all the shaded regions of space. If cell 2 were specified as  $-1 : 2$ , that would represent the region of space common to  $-1$  and  $2$ , which is only the cross-hatched region in the figure and is obviously an improper specification for cell 2.

Returning to Figure 1.4 on page 1-16, if cell 1 is inside the solid black line and cell 2 is the entire region outside the solid line, then the MCNP cell cards in two dimensions are (assuming both cells are voids)

```

1 0 1 -2 (-3 : -4) 5
2 0 -5 : -1 : 2 : 3 4

```

Cell 1 is defined as the region above surface 1 intersected with the region to the left of surface 2, intersected with the union of regions below surfaces 3 and 4, and finally intersected with the region to the right of surface 5. Cell 2 contains four concave corners (all but between surfaces 3 and 4), and its specification is just the converse (or complement) of cell 1. Cell 2 is the space defined by the region to the left of surface 5 plus the region below 1 plus the region to the right of 2 plus the space defined by the intersections of the regions above surfaces 3 and 4.

A simple consistency check can be noted with the twocell cards above. All intersections for cell 1 become unions for cell 2 and vice versa. The senses are also reversed.

Note that in this example, all corners less than 180 degrees in a cell are handled by intersections and all corners greater than 180 degrees are handled by unions.

To illustrate some of the concepts about parentheses, assume an intersection is thought of mathematically as multiplication and a union is thought of mathematically as addition. Parentheses are removed first, with multiplication being performed before addition. The cell cards for the example cards above from Figure 1.4 may be written in the form

$$\begin{array}{ll} 1 & a \cdot b \cdot (c + d) \cdot e \\ 2 & e + a + b + c \cdot d \end{array}$$

Note that parentheses are required for the first cell but not for the second, although the second could have been written as  $e + a + b + (c \cdot d)$ ,  $(e + a + b) + (c \cdot d)$ ,  $(e) + (a) + (b) + (c \cdot d)$ , etc.

Several more examples using the union operator are given in Chapter 4. Study them to get a better understanding of this powerful operator that can greatly simplify geometry setups.

### ***B. Surface Type Specification***

The first- and second-degree surfaces plus the fourth-degree elliptical and degenerate tori of analytical geometry are all available in MCNP. The surfaces are designated by mnemonics such as C/Z for a cylinder parallel to the z-axis. A cylinder at an arbitrary orientation is designated by the general quadratic GQ mnemonic. A paraboloid parallel to a coordinate axis is designated by the special quadratic SQ mnemonic. The 29 mnemonics representing various types of surfaces are listed in Table 3.1 on page 3–14.

### ***C. Surface Parameter Specification***

There are two ways to specify surface parameters in MCNP: (1) by supplying the appropriate coefficients needed to satisfy the surface equation, and (2) by specifying known geometrical points on a surface that is rotationally symmetric about a coordinate axis.

#### **1. Coefficients for the Surface Equations**

The first way to define a surface is to use one of the surface-type mnemonics from Table 3.1 on page 3–14 and to calculate the appropriate coefficients needed to satisfy the surface equation. For example, a sphere of radius 3.62-cm with the center located at the point (4,1,-3) is specified by

$$S \quad 4 \quad 1 \quad -3 \quad 3.62$$

An ellipsoid whose axes are not parallel to the coordinate axes is defined by the GQ mnemonic plus up to 10 coefficients of the general quadratic equation. Calculating the coefficients can be (and frequently is) nontrivial, but the task is greatly simplified by defining an auxiliary coordinate system whose axes coincide with the axes of the ellipsoid. The ellipsoid is easily defined in terms of the auxiliary coordinate system, and the relationship between the auxiliary coordinate system and the main coordinate system is specified on a TRn card, described on page 3–30.

The use of the SQ (special quadratic) and GQ (general quadratic) surfaces is determined by the orientation of the axes. One should always use the simplest possible surface in describing

## CHAPTER 1

### MCNP INPUT FOR SAMPLE PROBLEM

geometries; for example, using a GQ surface instead of an S to specify a sphere will require more computational effort for MCNP.

#### 2. Points that Define a Surface

The second way to define a surface is to supply known points on the surface. This method is convenient if you are setting up a geometry from something like a blueprint where you know the coordinates of intersections of surfaces or points on the surfaces. When three or more surfaces intersect at a point, this second method also produces a more nearly perfect point of intersection if the common point is used in the surface specification. It is frequently difficult to get complicated surfaces to meet at one point if the surfaces are specified by the equation coefficients. Failure to achieve such a meeting can result in the unwanted loss of particles.

There are, however, restrictions that must be observed when specifying surfaces by points that do not exist when specifying surfaces by coefficients. Surfaces described by points must be either skew planes or surfaces rotationally symmetric about the x, y, or z axes. They must be unique, real, and continuous. For example, points specified on both sheets of a hyperboloid are not allowed because the surface is not continuous. However, it is valid to specify points that are all on one sheet of the hyperboloid. (See the X,Y,Z, and P input cards description on page 3–16 for additional explanation.)

## IV. MCNP INPUT FOR SAMPLE PROBLEM

The main input file for the user is the INP (the default name) file that contains the input information to describe the problem. We will present here only the subset of cards required to run the simple fixed source demonstration problem. All input cards are discussed in Chapter 3 and summarized in Table 3.8 starting on page 3–148.

MCNP does extensive input checking but is not foolproof. A geometry should be checked by looking at several different views with the geometry plotting option. You should also surround the entire geometry with a sphere and flood the geometry with particles from a source with an inward cosine distribution on the spherical surface, using a VOID card to remove all materials specified in the problem. If there are any incorrectly specified places in your geometry, this procedure will usually find them. Make sure the importance of the cell just inside the source sphere is not zero. Then run a short job and study the output to see if you are calculating what you think you are calculating.

The basic constants used in MCNP are printed in optional print table 98 in the output file. The units used are:

1. lengths in centimeters,
2. energies in MeV,
3. times in shakes ( $10^{-8}$  sec),

4. temperatures in MeV ( $kT$ ),
5. atomic densities in units of atoms/barn-cm,
6. mass densities in  $\text{g/cm}^3$ ,
7. cross sections in barns ( $10^{-24} \text{ cm}^2$ ),
8. heating numbers in MeV/collision, and
9. atomic weight ratio based on a neutron mass of 1.008664967. In these units, Avogadro's number is  $0.59703109 \times 10^{-24}$ .

A simple sample problem illustrated in Figure 1.7 is referred to throughout the remainder of this chapter. We wish to start 14-MeV neutrons at a point isotropic source in the center of a small sphere of oxygen that is embedded in a cube of carbon. A small sphere of iron is also embedded in the carbon. The carbon is a cube 10 cm on each side; the spheres have a 0.5-cm radius and are centered between the front and back faces of the cube. We wish to calculate the total and energy-dependent flux in increments of 1 MeV from 1 to 14 MeV, where bin 1 will be the tally from 0 to 1 MeV

1. on the surface of the iron sphere and
2. averaged in the iron sphere volume.

This geometry has four cells, indicated by circled numbers, and eight surfaces—six planes and two spheres. Surface numbers are written next to the appropriate surfaces. Surface 5 comes out from the page in the +x direction and surface 6 goes back into the page in the -x direction.

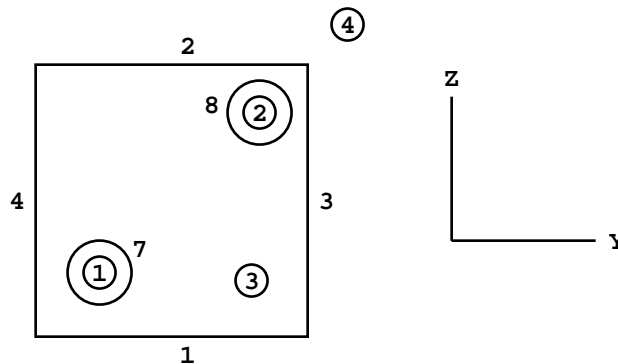

**Figure 1-7.**

With knowledge of the cell card format, the sense of a surface, and the union and intersection operators, we can set up the cell cards for the geometry of our example problem. To simplify this step, assume the cells are void, for now. Cells 1 and 2 are described by the following cards:

```

1  0  -7
2  0  -8

```

where the negative signs denote the regions inside (negative sense) surfaces 7 and 8. Cell 3 is everything in the universe above surface 1 intersected with everything below surface 2 intersected with everything to the left of surface 3 and so forth for the remaining three surfaces. The region in

## CHAPTER 1

### MCNP INPUT FOR SAMPLE PROBLEM

common to all six surfaces is the cube, but we need to exclude the two spheres by intersecting everything outside surface 7 and outside surface 8. The card for cell 3 is

```
3 0 1 -2 -3 4 -5 6 7 8
```

Cell 4 requires the use of the union operator and is similar to the idea illustrated in Figure 1.6. Cell 4 is the outside world, has zero importance, and is defined as everything in the universe below surface 1 plus everything above surface 2 plus everything to the right of surface 3 and so forth. The cell card for cell 4 is

```
4 0 -1 : 2 : 3 : -4 : 5 : -6
```

#### A. *INP File*

An input file has the following form:

```
Message Block      } Optional  
Blank Line Delimiter }  
One Line Problem Title Card  
Cell Cards  
:  
Blank Line Delimiter  
Surface Cards  
:  
Blank Line Delimiter  
Data Cards  
:  
Blank Line Terminator (optional)
```

All input lines are limited to 80 columns. Alphabetic characters can be upper, lower, or mixed case. A \$ (dollar sign) terminates data entry. Anything that follows the \$ is interpreted as a comment. Blank lines are used as delimiters and as an optional terminator. Data entries are separated by one or more blanks.

Comment cards can be used anywhere in the INP file after the problem title card and before the optional blank terminator card. Comment lines must have a C somewhere in columns 1-5 followed by at least one blank and can be a total of 80 columns long.

Cell, surface, and data cards must all begin within the first five columns. Entries are separated by one or more blanks. Numbers can be integer or floating point. MCNP makes the appropriate conversion. A data entry item, e.g., IMP:N or 1.1e2, must be completed on one line.

Blanks filling the first five columns indicate a continuation of the data from the last named card. An & (ampersand) ending a line indicates data will continue on the following card, where data on the continuation card can be in columns 1-80.

The optional message block, discussed in detail on page 3-1, is used to change file names and specify running options such as a continuation run. On most systems these options and files may alternatively be specified with an execution line message (see page 1-32). Message block entries supersede execution line entries. The blank line delimiter signals the end of the message block.

The first card in the file after the optional message block is the required problem title card. If there is no message block, this must be the first card in the INP file. It is limited to one 80-column line and is used as a title in various places in the MCNP output. It can contain any information you desire but usually contains information describing the particular problem.

MCNP makes extensive checks of the input file for user errors. A FATAL error occurs if a basic constraint of the input specification is violated, and MCNP will terminate before running any particles. The first fatal error is real; subsequent error messages may or may not be real because of the nature of the first fatal message.

### ***B. Cell Cards***

The cell number is the first entry and must begin in the first five columns.

The next entry is the cell material number, which is arbitrarily assigned by the user. The material is described on a material card (Mn) that has the same material number (see page 1-29). If the cell is a void, a zero is entered for the material number. The cell and material numbers cannot exceed 5 digits.

Next is the cell material density. A positive entry is interpreted as atom density in units of  $10^{24}$  atoms/cm<sup>3</sup>. A negative entry is interpreted as mass density in units of g/cm<sup>3</sup>. No density is entered for a void cell.

A complete specification of the geometry of the cell follows. This specification includes a list of the signed surfaces bounding the cell where the sign denotes the sense of the regions defined by the surfaces. The regions are combined with the Boolean intersection and union operators. A space indicates an intersection and a colon indicates a union.

Optionally, after the geometry description, cell parameters can be entered. The form is keyword=value. The following line illustrates the cell card format:

```
1 1 -0.0014 -7 IMP:N=1
```



**CHAPTER 1**  
**MCNP INPUT FOR SAMPLE PROBLEM**

Cell 1 contains material 1 with density 0.0014 g/cm<sup>3</sup>, is bounded by only one surface (7), and has an importance of 1. If cell 1 were a void, the cell card would be

```
1 0 -7 IMP:N=1
```

The complete cell card input for this problem (with 2 comment cards) is

```
c cell cards for sample problem
1 1 -0.0014 -7
2 2 -7.86 -8
3 3 -1.60 1 -2 -3 4 -5 6 7 8
4 0 -1:2:3:-4:5:-6
c end of cell cards for sample problem
blank line delimiter
```

The blank line terminates the cell card section of the INP file. We strongly suggest that the cells be numbered sequentially starting with one. A complete explanation of the cell card input is found in Chapter 3, page 3–9.

**C. Surface Cards**

The surface number is the first entry. It must begin in columns 1-5 and not exceed 5 digits. The next entry is an alphabetic mnemonic indicating the surface type. Following the surface mnemonic are the numerical coefficients of the equation of the surface in the proper order. This simplified description enables us to proceed with the example problem. For a full description of the surface card see page 3–12.

Our problem uses planes normal to the x, y, and z axes and two general spheres. The respective mnemonics are PX, PY, PZ, and S. Table 1.2 shows the equations that determine the sense of the surface for the cell cards and the entries required for the surface cards. A complete list of available surface equations is contained in Table 3.1 on page 3–14.

**TABLE 1.2:**  
**Surface Equations**

<u>Mnemonic</u>	<u>Equation</u>	<u>Card Entries</u>
PX	$x - D = 0$	D
PY	$y - D = 0$	D
PZ	$z - D = 0$	D
S	$(x - \bar{x})^2 + (y - \bar{y})^2 + (z - \bar{z})^2 - R^2 = 0$	$\bar{x}\bar{y}\bar{z}R$

For the planes, D is the point where the plane intersects the axis. If we place the origin in the center of the 10-cm cube shown in Figure 1.7, the planes will be at  $x = -5$ ,  $x = 5$ , etc. The two spheres are not centered at the origin or on an axis, so we must give the  $x,y,z$  of their center as well as their radii. The complete surface card input for this problem is shown below. A blank line terminates the surface card portion of the input.

```

C Beginning of surfaces for cube
  1 PZ   -5
  2 PZ    5
  3 PY    5
  4 PY   -5
  5 PX    5
  6 PX   -5
C End of cube surfaces
  7 S 0  -4 -2.5  .5 $ oxygen sphere
  8 S 0   4  4   .5 $ iron sphere
blank line delimiter

```

#### *D. Data Cards*

The remaining data input for MCNP follows the second blank card delimiter, or third blank card if there is a message block. The card name is the first entry and must begin in the first five columns. The required entries follow, separated by one or more blanks.

Several of the data cards require a particle designator to distinguish between input data for neutrons, data for photons, and data for electrons. The particle designator consists of the symbol : (colon) and the letter N or P or E immediately following the name of the card. For example, to enter neutron importances, use an IMP:N card; enter photon importances on an IMP:P card; enter electron importances on an IMP:E card. No data card can be used more than once with the same mnemonic, that is, M1 and M2 are acceptable, but two M1 cards are not allowed. Defaults have been set for cards in some categories. A summary starting on page 3–147 shows which cards are required, which are optional, and whether defaults exist and if so, what they are. The sample problem will use cards in the following categories:

	<u>MCNP card name</u>
1. mode,	MODE
2. cell and surface parameters,	IMP:N
3. source specification,	SDEF
4. tally specification,	Fn, En
5. material specification, and	Mn
6. problem cutoffs.	NPS

## CHAPTER 1

### MCNP INPUT FOR SAMPLE PROBLEM

A complete description of the data cards is found on page 3–22 in Chapter 3.

#### 1. MODE Card

MCNP can be run in several different modes:

Mode	N	— neutron transport only (default)
	N P	— neutron and neutron-induced photon transport
	P	— photon transport only
	E	— electron transport only
	P E	— photon and electron transport
	N P E	— neutron, neutron-induced photon and electron transport

The MODE card consists of the mnemonic MODE followed by the choices shown above. If the MODE card is omitted, mode N is assumed.

Mode N P does not account for photo-neutrons but only neutron-induced photons. Photon-production cross sections do not exist for all nuclides. If they are not available for a Mode N P problem, MCNP will print out warning messages. To find out whether a particular table for a nuclide has photon-production cross sections available, check the Appendix G cross-section list.

Mode P or mode N P problems generate bremsstrahlung photons with a computationally expensive thick-target bremsstrahlung approximation. This approximation can be turned off with the PHYS:E card.

The sample problem is a neutron-only problem, so the MODE card can be omitted because MODE N is the default.

#### 2. Cell and Surface Parameter Cards

Most of these cards define values of cell parameters. Entries correspond in order to the cell or surface cards that appear earlier in the INP file. A listing of all available cell and surface parameter cards is found on page 3–32. A few examples are neutron and photon importance cards (IMP:N,IMP:P), weight window cards (WWE:N, WWE:P, WWNi:N, WWNi:P), etc. Some method of specifying relative cell importances is required; the majority of the other cell parameter cards are for optional variance reduction techniques. The number of entries on a cell or surface parameter card must equal the number of cells or surfaces in the problem or MCNP prints out a WARNING or FATAL error message. In the case of a WARNING, MCNP assumes zeros.

The IMP:N card is used to specify relative cell importances in the sample problem. There are four cells in the problem, so the IMP:N card will have four entries. The IMP:N card is used (a) for terminating the particle's history if the importance is zero and (b) for geometry splitting and

Russian roulette to help particles move more easily to important regions of the geometry. An IMP:N card for the sample problem is

```
IMP:N 1 1 1 0
```

Cell parameters also can be defined on cell cards using the keyword=value format. If a cell parameter is specified on **any** cell card, it must be specified **only** on cell cards and **not at all** in the data card section.

### 3. Source Specification Cards

A source definition card SDEF is one of four available methods of defining starting particles. Chapter 3 has a complete discussion of source specification. The SDEF card defines the basic source parameters, some of which are

POS = x y z	default is 0 0 0;
CEL = starting cell number	
ERG = starting energy	default is 14 MeV;
WGT = starting weight	default is 1;
TME = time	default is 0;
PAR = source particle type	1 for N, N P, N P E; 2 for P, P E; 3 for E.

MCNP will determine the starting cell number for a point isotropic source, so the CEL entry is not always required. The default starting direction for source particles is isotropic.

For the example problem, a fully specified source card is

```
SDEF POS = 0 -4 -2.5 CEL = 1 ERG = 14 WGT = 1 TME = 0 PAR = 1
```

Neutron particles will start at the center of the oxygen sphere (0 -4 -2.5), in cell 1, with an energy of 14 MeV, and with weight 1 at time 0. All these source parameters except the starting position are the default values, so the most concise source card is

```
SDEF POS = 0 -4 -2.5
```

If all the default conditions applied to the problem, only the mnemonic SDEF would be required.

### 4. Tally Specification Cards

The tally cards are used to specify what you want to learn from the Monte Carlo calculation, perhaps current across a surface, flux at a point, etc. You request this information with one or more tally cards. Tally specification cards are not required, but if none is supplied, no tallies will be

# CHAPTER 1

## MCNP INPUT FOR SAMPLE PROBLEM

printed when the problem is run and a warning message is issued. Many of the tally specification cards describe tally “bins.” A few examples are energy (En), time (Tn), and cosine (Cn) cards.

MCNP provides six standard neutron, six standard photon, and four standard electron tallies, all normalized to be per starting particle. Some tallies in criticality calculations are normalized differently. Chapter 2, page 2–76, discusses tallies more completely, and Chapter 3, page 3–73, lists all the tally cards and fully describes each one.

Tally Mnemonic			Description
F1:N	or F1:P	or F1:E	Surface current
F2:N	or F2:P	or F2:E	Surface flux
F4:N	or F4:P	or F4:E	Track length estimate of cell flux
F5a:N	or F5a:P		Flux at a point (point detector)
F6:N	or F6:N,P		Track length estimate of energy deposition
	or F6:P		
F7:N			Track length estimate of fission energy deposition
	F8:P	or F8:E	Energy distribution of pulses created
	or F8:P,E		in a detector

The tallies are identified by tally type and particle type. Tallies are given the numbers 1, 2, 4, 5, 6, 7, 8, or increments of 10 thereof, and are given the particle designator :N or :P or :E (or :N,P only in the case of tally type 6 or P,E only for tally type 8). Thus you may have as many of any basic tally as you need, each with different energy bins or flagging or anything else. F4:N, F14:N, F104:N, and F234:N are all legitimate neutron cell flux tallies; they could all be for the same cell(s) but with different energy or multiplier bins, for example. Similarly F5:P, F15:P, and F305:P are all photon point detector tallies. Having both an F1:N card and an F1:P card in the same INP file is not allowed. The tally number may not exceed three digits.

For our sample problem we will use Fn cards (Tally type) and En cards (Tally energy).

a. **Tally (Fn) Cards:** The sample problem has a surface flux tally and a track length cell flux tally. Thus, the tally cards for the sample problem shown in Figure 1.7 are

```
F2:N  8  $  flux across surface 8
F4:N  2  $  track length in cell 2
```

Printed out with each tally bin is the relative error of the tally corresponding to one estimated standard deviation. Read page 1–6 for an explanation of the relative error. Results are not reliable until they become stable as a function of the number of histories run. Much information is provided for one bin of each tally in the tally fluctuation charts at the end of the output file to help determine tally stability. The user is strongly encouraged to look at this information carefully.

b. Tally Energy (En) Card: We wish to calculate flux in increments of 1 MeV from 14 to 1 MeV. Another tally specification card in the sample input deck establishes these energy bins.

The entries on the En card are the upper bounds in MeV of the energy bins for tally n. The entries must be given in order of increasing magnitude. If a particle has an energy greater than the last entry, it will not be tallied, and a warning is issued. MCNP automatically provides the total over all specified energy bins unless inhibited by putting the symbol NT as the last entry on the selected En card.

The following cards will create energy bins for the sample problem:

```
E2    1 2 3 4 5 6 7 8 9 10 11 12 13 14
E4    1 12I 14
```

If no En card exists for tally n, a single bin over all energy will be used. To change this default, an E0 (zero) card can be used to set up a default energy bin structure for all tallies. A specific En card will override the default structure for tally n. We could replace the E2 and E4 cards with one E0 card for the sample problem, thus setting up identical bins for both tallies.

## 5. Materials Specification

The cards in this section specify both the isotopic composition of the materials and the cross-section evaluations to be used in the cells. For a comprehensive discussion of materials specification, see page 3–108.

a. Material (Mm) Card: The following card is used to specify a material for all cells containing material m, where m cannot exceed 5 digits:

```
Mm  ZAID1  fraction1  ZAID2  fraction2  ...
```

The m on a material card corresponds to the material number on the cell card (see page 1–23). The consecutive pairs of entries on the material card consist of the identification number (ZAID) of the constituent element or nuclide followed by the atomic fraction (or weight fraction if entered as a negative number) of that element or nuclide, until all the elements and nuclides needed to define the material have been listed.

- i. Nuclide Identification Number (ZAID). This number is used to identify the element or nuclide desired. The form of the number is ZZZAAA.nnX, where
  - ZZZ is the atomic number of the element or nuclide,
  - AAA is the mass number of the nuclide, ignored for photons and electrons,
  - nn is the cross-section evaluation identifier; if blank or zero, a default cross-section evaluation will be used, and

## CHAPTER 1

### MCNP INPUT FOR SAMPLE PROBLEM

X is the class of data: C is continuous energy; D is discrete reaction; T is thermal; Y is dosimetry; P is photon; E is electron; and M is multigroup.

For naturally occurring elements, AAA=000. Thus ZAID=74182 represents the isotope  $^{182}_{74}\text{W}$ , and ZAID=74000 represents the element tungsten.

- ii. Nuclide Fraction. The nuclide fractions may be normalized to 1 or left unnormalized. For example, if the material is H<sub>2</sub>O, the fractions can be entered as .667 and .333, or as 2 and 1 for H and O respectively. If the fractions are entered with negative signs, they are weight fractions; otherwise they are atomic fractions. Weight fractions and atomic fractions cannot be mixed on the same Mm card.

The material cards for the sample problem are

M1	8016	1	\$ oxygen 16
M2	26000	1	\$ natural iron
M3	6000	1	\$ carbon

b. VOID Card: The VOID card removes all materials and cross sections in a problem and sets all nonzero importances to unity. It is very effective for finding errors in the geometry description because many particles can be run in a short time. Flooding the geometry with many particles increases the chance of particles going to most parts of the geometry—in particular, to an incorrectly specified part of the geometry—and getting lost. The history of a lost particle often helps locate the geometry error. The other actions of and uses for the VOID card are discussed on page 3–113.

The sample input deck could have a VOID card while testing the geometry for errors. When you are satisfied that the geometry is error-free, remove the VOID card.

#### 6. Problem Cutoffs

Problem cutoff cards are used to specify parameters for some of the ways to terminate execution of MCNP. The full list of available cards and a complete discussion of problem cutoffs is found on page 3–124. For our problem we will use only the history cutoff (NPS) card. The mnemonic NPS is followed by a single entry that specifies the number of histories to transport. MCNP will terminate after NPS histories unless it has terminated earlier for some other reason.

7. Sample Problem Summary

The entire input deck for the sample problem follows. Recall that the input can be upper, lower, or mixed case.

```

Sample Problem Input Deck
c      cell cards for sample problem
1      1 -0.0014  -7
2      2 -7.86    -8
3      3 -1.60      1 -2 -3 4 -5 6 7 8
4      0          -1:2:3:-4:5:-6
c      end of cell cards for sample problem
C      Beginning of surfaces for cube
1      PZ  -5
2      PZ   5
3      PY   5
4      PY  -5
5      PX   5
6      PX  -5
C      End of cube surfaces
7      S 0 -4 -2.5 .5          $ oxygen sphere
8      S 0  4  4.5           $ iron sphere
blank line delimiter
IMP:N  1  1  1  0
SDEF  POS=0 -4 -2.5
F2:N   8          $ flux across surface 8
F4:N   2          $ track length in cell 2
E0     1 12I 14
M1     8016  1    $ oxygen 16
M2     26000 1    $ natural iron
M3     6000  1    $ carbon
NPS    100000
blank line delimiter (optional)

```

**V. HOW TO RUN MCNP**

This section assumes a basic knowledge of UNIX. Lines the user will type are shown in **lower case typewriter style** type. Press the RETURN key after each input line. MCNP is the executable binary file and XSDIR is the cross-section directory. If XSDIR is not in your current directory, you may need to set the environmental variable:

```
setenv DATAPATH /ab/cd
```



# CHAPTER 1

## HOW TO RUN MCNP

where `/ab/cd` is the directory containing both XSDIR and the data libraries.

### A. *Execution Line*

The MCNP execution line has the following form:

```
mcnp Files Options
```

*Files* and *Options* are described below. Their order on the execution line is irrelevant. If there are no changes in default file names, nothing need be entered for *Files* and *Options*.

#### 1. Files

MCNP uses several files for input and output. The file names cannot be longer than eight characters. The files pertinent to the sample problem are shown in Table 1.3. File INP must be present as a local file. MCNP will create OUTP and RUNTPE.

**TABLE 1.3:**  
**MCNP Files**

<u>Default File Name</u>	<u>Description</u>
INP	Problem input specification
OUTP	BCD output for printing
RUNTPE	Binary start-restart data
XSDIR	Cross-section directory

The default name of any of the files in Table 1.3 can be changed on the MCNP execution line by entering

```
default_file_name=newname
```

For example, if you have an input file called MCIN and want the output file to be MCOUT and the runtpe to be MCRUNTPE, the execution line is

```
mcnp inp=mcin outp=mcout runtpe=mcruntpe
```

Only enough letters of the default name are required to uniquely identify it. For example,

```
mcnp i=mcin o=mcout ru=mcrntpe
```

also works. If a file in your local file space has the same name as a file MCNP needs to create, the file is created with a different unique name by changing the last letter of the name of the new file

to the next letter in the alphabet. For example, if you already have an OUTF, MCNP will create OUTQ.

Sometimes it is useful for all files from one run to have similar names. If your input file is called JOB1, the following line

```
mcnp name=job1
```

will create an OUTF file called JOB1O and a RUNTPE file called JOB1R. If these files already exist, MCNP will NOT overwrite them, but will issue a message that JOB1O already exists and then will terminate.

## 2. Options

There are two kinds of options: program module execution options and other options. Execution options are discussed next.

MCNP consists of five distinct execution operations, each given a module name. These operations, their corresponding module names, and a one-letter mnemonic for each operation are listed in Table 1.4.

**TABLE 1.4:**  
**Execution Options**

<u>Mnemonic</u>	<u>Module</u>	<u>Operation</u>
i	IMCN	Process problem input file
p	PLOT	Plot geometry
x	XACT	Process cross sections
r	MCRUN	Particle transport
z	MCPLOT	Plot tally results or cross section data

When *Options* are omitted, the default is **ixr**. The execution of the modules is controlled by entering the proper mnemonic on the execution line. If more than one operation is desired, combine the single characters (in any order) to form a string. Examples of use are as follows: **i** to look for input errors, **ip** to debug a geometry by plotting, **ixz** to plot cross-section data, and **z** to plot tally results from the RUNTPE file.

After a job has been run, the BCD print file OUTF can be examined with an editor on the computer and/or sent to a printer. Numerous messages about the problem execution and statistical quality of the results are displayed at the terminal.

## CHAPTER 1 HOW TO RUN MCNP

The “other” options add more flexibility when running MCNP and are shown in Table 1.5.

**TABLE 1.5:  
Other Options**

<u>Mnemonic</u>	<u>Operation</u>
C m	Continue a run starting with m <sup>th</sup> dump. If m is omitted, last dump is used. See page 3–2
CN	Like C, but dumps are written immediately after the fixed part of the RUNTPE, rather than at the end. See page 3–2
DEBUG n	Write debug information every n particles. See DBCN card, page 3–130
NOTEK	Indicates that your terminal has no graphics capability. PLOT output is in PLOTM.PS. Equivalent to TERM=0. See
FATAL	Transport particles and calculate volumes even if fatal errors are found.
PRINT	Create the full output file; equivalent to PRINT card. See page 3–134
TASKS n	Invokes multiprocessing on common or distributed memory systems. n=number of processors to be used. –n is allowed only on distributed memory systems to disable load balancing and fault tolerance, increasing system efficiency.

The TASK option must be used to invoke multiprocessing on common or distributed memory computer systems and is followed by the number of tasks or CPUs to be used for particle tracking. The multiprocessing capability must be invoked at the time of compilation to create a compatible executable. Two compilation options exist: common memory systems (UNICOS, etc.) and distributed memory systems (workstation clusters, Cray T3D, etc.) While multiprocessing on common memory systems is invoked and handled by the compiler with compiler directives, on distributed memory systems it is performed by the software communications package Parallel Virtual Machine<sup>9</sup> (PVM). Thus, using this capability on distributed memory systems requires the installation and execution of PVM.<sup>10</sup> On such systems, a negative entry following the TASKS option will maximize efficiency for homogeneous dedicated systems (e.g., workstation with multiple CPUs). For heterogeneous or multiuser systems, a positive entry should be used, in which case load balancing and fault tolerance are enabled.<sup>11</sup> In either case, the absolute value of this entry indicates the number of hosts (or CPUs) available for use during particle tracking. On both common and distributed memory systems, a table is provided in the output file that lists the number of particles tracked by each host.

```
mcnp i=input o=output tasks 8
```

Indicates eight processors are to be used for particle tracking. On a common memory system, eight tasks are initiated (if fewer processors are actually available, multiple tasks are run on each processor.) On a distributed memory system, the master task and one subtask are initiated on the primary host (i.e., machine from which the execution is initiated), and a subtask is initiated on each of the seven secondary hosts.

```
mcnp name=inp tasks -4
```

A negative entry following the TASKS option is allowed only on a distributed memory system and is recommended for homogeneous dedicated systems. As in the previous example, the master task and one subtask are initiated on the primary host, and a subtask is initiated on each of the three secondary hosts. The negative entry disables load balancing and fault tolerance, increasing system efficiency.

### ***B. Interrupts***

MCNP allows four interactive interrupts while it is running:

(ctrl c)<cr>	(default)	MCNP status
(ctrl c)s		MCNP status
(ctrl c)m		Make interactive plots of tallies
(ctrl c)q		Terminate MCNP normally after current history
(ctrl c)k		Kill MCNP immediately

The (ctrl c)s interrupt prints the computer time used so far, the number of particles run so far, and the number of collisions. In the IMCN module, it prints the input line being processed. In the XACT module, it prints the cross section being processed.

The (ctrl c)q interrupt has no effect until MCRUN is executed. (Ctrl c)q causes the code to stop after the current particle history, to terminate “gracefully,” and to produce a final print output file and RUNTPE file.

The (ctrl c)k interrupt kills MCNP immediately, without normal termination. If (ctrl c)k fails, enter (ctrl c) three or more times in a row.

### ***C. Running MCNP***

To run the example problem, have the input file in your current directory. For illustration, assume the file is called SAMPLE. Type

```
mcnp n=sample
```

where n uniquely identifies NAME. MCNP will produce an output file SAMPLEO that you can examine at your terminal, send to a printer, or both. To look at the geometry with the PLOT module using an interactive graphics terminal, type in

```
mcnp ip n=sample
```

## CHAPTER 1

### TIPS FOR CORRECT AND EFFICIENT PROBLEMS

After the plot prompt *plot >* appears, type in

```
px=0    ex=20
```

This plot will show an intersection of the surfaces of the problem by the plane  $X = 0$  with an extent in the x-direction of 20 cm on either side of the origin. If you want to do more with PLOT, see the instructions on page B-1. Otherwise type “end” after the next prompt to terminate the session.

## VI. TIPS FOR CORRECT AND EFFICIENT PROBLEMS

This section has a brief checklist of helpful hints that apply to three phases of your calculation: defining and setting up the problem, preparing for the long computer runs that you may require, and making the runs that will give you results. Not everything mentioned in the checklist has been covered in this chapter, but the list can serve as a springboard for further reading in preparation for tackling more difficult problems.

### A. Problem Setup

1. Model the geometry and source distribution accurately.
2. Use the best problem cutoffs.
3. Use zero (default) for the neutron energy cutoff (MODE N P).
4. Do not use too many variance reduction techniques.
5. Use the most conservative variance reduction techniques.
6. Do not use cells with many mean free paths.
7. Use simple cells.
8. Use the simplest surfaces.
9. Study warning messages.
10. Always plot the geometry.
11. Use the VOID card when checking geometry.
12. Use separate tallies for the fluctuation chart.
13. Generate the best output (consider PRINT card).
14. RECHECK the INP file (materials, densities, masses, sources, etc.).
15. GARBAGE into code = GARBAGE out of code.

### B. Preproduction

1. Run some short jobs.
2. Examine the outputs carefully.
3. Study the summary tables.
4. Study the statistical checks on tally quality and the sources of variance.
5. Compare the figures of merit and variance of the variance.

6. Consider the collisions per source particle.
7. Examine the track populations by cell.
8. Scan the mean free path column.
9. Check detector diagnostic tables.
10. Understand large detector contributions.
11. Strive to eliminate unimportant tracks.
12. Check MODE N P photon production.
13. Do a back-of-the-envelope check of the results.
14. DO NOT USE MCNP AS A BLACK BOX.

**C. *Production***

1. Save RUNTPE for expanded output printing, continue run, tally plotting.
2. Look at figure of merit stability.
3. Make sure answers seem reasonable.
4. Make continue runs if necessary.
5. See if stable errors decrease by  $1/\sqrt{N}$  (that is, be careful of the brute force approach).
6. Remember, accuracy is only as good as the nuclear data, modeling, MCNP sampling approximations, etc.

## CHAPTER 1 REFERENCES

### VII. REFERENCES

1. R. Kinsey, "Data Formats and Procedures for the Evaluated Nuclear Data File, ENDF," Brookhaven National Laboratory report BNL-NCS-50496 (ENDF 102) 2nd Edition (ENDF/B-V) (October 1979).
2. R. J. Howerton, D. E. Cullen, R. C. Haight, M. H. MacGregor, S. T. Perkins, and E. F. Plechaty, "The LLL Evaluated Nuclear Data Library (ENDL): Evaluation Techniques, Reaction Index, and Descriptions of Individual Reactions," Lawrence Livermore National Laboratory report UCRL-50400, Vol. 15, Part A (September 1975).
3. M. A. Gardner and R. J. Howerton, "ACTL: Evaluated Neutron Activation Cross-Section Library-Evaluation Techniques and Reaction Index," Lawrence Livermore National Laboratory report UCRL-50400, Vol. 18 (October 1978).
4. E. D. Arthur and P. G. Young, "Evaluated Neutron-Induced Cross Sections for  $^{54,56}\text{Fe}$  to 40 MeV," Los Alamos Scientific Laboratory report LA-8626-MS (ENDF-304) (December 1980).
5. D. G. Foster, Jr. and E. D. Arthur, "Average Neutronic Properties of "Prompt" Fission Products," Los Alamos National Laboratory report LA-9168-MS (February 1982).
6. E. D. Arthur, P. G. Young, A. B. Smith, and C. A. Philis, "New Tungsten Isotope Evaluations for Neutron Energies Between 0.1 and 20 MeV," *Trans. Am. Nucl. Soc.* **39**, 793 (1981).
7. R. E. MacFarlane, D. W. Muir, and R. M. Boicourt, "The NJOY Nuclear Data Processing System, Volume I: User's Manual," Los Alamos National Laboratory report LA-9303-M, Vol. I (ENDF-324) (May 1982).  
R. E. MacFarlane, D. W. Muir, and R. M. Boicourt, "The NJOY Nuclear Data Processing System, Volume II: The NJOY, RECONR, BROADR, HEATR, and THERMR Modules," Los Alamos National Laboratory report LA-9303-M, Vol. II (ENDF-324) (May 1982).
8. R. A. Forster, R. C. Little, J. F. Briesmeister, and J. S. Hendricks, "MCNP Capabilities For Nuclear Well Logging Calculations," *IEEE Transactions on Nuclear Science*, **37** (3), 1378 (June 1990)
9. A. Geist et al, "PVM 3 User's Guide and Reference Manual," ORNL/TM-12187, Oak Ridge National Laboratory (1993).
10. G. McKinney, "A Practical Guide to Using MCNP with PVM," *Trans. Am. Nucl. Soc.* **71**, 397 (1994).
11. G. McKinney, "MCNP4B Multiprocessing Enhancements Using PVM," LANL memo X-6:GWM-95-212 (1995).

## CHAPTER 2

### GEOMETRY, DATA, PHYSICS, AND MATHEMATICS

#### I. INTRODUCTION

Chapter 2 discusses the mathematics and physics of MCNP, including geometry, cross-section libraries, sources, variance reduction schemes, Monte Carlo simulation of neutron and photon transport, and tallies. This discussion is not meant to be exhaustive; many details of the particular techniques and of the Monte Carlo method itself will be found elsewhere. Carter and Cashwell's book *Particle-Transport Simulation with the Monte Carlo Method*,<sup>1</sup> a good general reference on radiation transport by Monte Carlo, is based upon what is in MCNP. A more recent reference is Lux and Koblinger's book, *Monte Carlo Particle Transport Methods: Neutron and Photon Calculations*.<sup>2</sup> Methods of sampling from standard probability densities are discussed in the Monte Carlo samplers by Everett and Cashwell.<sup>3</sup>

MCNP was originally developed by the Monte Carlo Group, currently the Diagnostic Applications Group, (Group X-5) in the Applied Physics Division (X Division) at the Los Alamos National Laboratory. Group X-5 improves MCNP (releasing a new version every two to three years), maintains it at Los Alamos and at other laboratories where we have collaborators or sponsors, and provides limited free consulting and support for MCNP users. MCNP is distributed to other users through the Radiation Safety Information Computational Center (RSICC) at Oak Ridge, Tennessee, and the OECD/NEA data bank in Paris, France.

MCNP has approximately 48,000 lines of FORTRAN and 1000 lines of C source coding, including comments, and with the COMMON blocks listed only once and not in every subroutine. There are about 385 subroutines. There is only one source code; it is used for all systems. At Los Alamos, there are about 250 active users. Worldwide, there are about 3000 active users at about 200 installations.

MCNP takes advantage of parallel computer architectures. It is supported in multitasking mode on some mainframes and in multiprocessing mode on a cluster of workstations where the distributed processing uses the Parallel Virtual Machine (PVM) software from Oak Ridge.

MCNP has not been successfully vectorized because the overhead required to set up and break apart vector queues at random decision points is greater than the savings from vectorizing the simple arithmetic between the decision points. MCNP (and any general Monte Carlo code) is little more than a collection of random decision points with some simple arithmetic in between. Because MCNP does not take advantage of vectorization, it is fairly inefficient on vectorized computers. In particular, many workstations and PCs run MCNP as fast or faster than mainframes. MCNP has been made as system independent as possible to enhance its portability,



## CHAPTER 2 INTRODUCTION

and has been written to comply with the ANSI FORTRAN 77 standard. With one source code, MCNP is maintained on many platforms.

### A. *History*

The Monte Carlo method is generally attributed to scientists working on the development of nuclear weapons in Los Alamos during the 1940s. However, its roots go back much farther.

Perhaps the earliest documented use of random sampling to solve a mathematical problem was that of Comte de Buffon in 1772.<sup>4</sup> A century later people performed experiments in which they threw a needle in a haphazard manner onto a board ruled with parallel straight lines and inferred the value of  $\pi$  from observations of the number of intersections between needle and lines.<sup>5,6</sup> Laplace suggested in 1786 that  $\pi$  could be evaluated by random sampling.<sup>7</sup> Lord Kelvin appears to have used random sampling to aid in evaluating some time integrals of the kinetic energy that appear in the kinetic theory of gasses<sup>8</sup> and acknowledged his secretary for performing calculations for more than 5000 collisions.<sup>9</sup>

According to Emilio Segrè, Enrico Fermi's student and collaborator, Fermi invented a form of the Monte Carlo method when he was studying the moderation of neutrons in Rome.<sup>9,10</sup> Though Fermi did not publish anything, he amazed his colleagues with his predictions of experimental results. After indulging himself, he would reveal that his “guesses” were really derived from the statistical sampling techniques that he performed in his head when he couldn't fall asleep.

During World War II at Los Alamos, Fermi joined many other eminent scientists to develop the first atomic bomb. It was here that Stan Ulam became impressed with electromechanical computers used for implosion studies. Ulam realized that statistical sampling techniques were considered impractical because they were long and tedious, but with the development of computers they could become practical. Ulam discussed his ideas with others like John von Neumann and Nicholas Metropolis. Statistical sampling techniques reminded everyone of games of chance, where randomness would statistically become resolved in predictable probabilities. It was Nicholas Metropolis who noted that Stan had an uncle who would borrow money from relatives because he “just had to go to Monte Carlo” and thus named the mathematical method “Monte Carlo.”<sup>10</sup>

Meanwhile, a team of wartime scientists headed by John Mauchly was working to develop the first electronic computer at the University of Pennsylvania in Philadelphia. Mauchly realized that if Geiger counters in physics laboratories could count, then they could also do arithmetic and solve mathematical problems. When he saw a seemingly limitless array of women cranking out firing tables with desk calculators at the Ballistic Research Laboratory at Aberdeen, he proposed<sup>10</sup> that an electronic computer be built to deal with these calculations. The result was ENIAC (Electronic Numerical Integrator and Computer), the world's first computer, built for

Aberdeen at the University of Pennsylvania. It had 18,000 double triode vacuum tubes in a system with 500,000 solder joints.<sup>10</sup>

John von Neumann was a consultant to both Aberdeen and Los Alamos. When he heard about ENIAC, he convinced the authorities at Aberdeen that he could provide a more exhaustive test of the computer than mere firing-table computations. In 1945 John von Neumann, Stan Frankel, and Nicholas Metropolis visited the Moore School of Electrical Engineering at the University of Pennsylvania to explore using ENIAC for thermonuclear weapon calculations with Edward Teller at Los Alamos.<sup>10</sup> After the successful testing and dropping of the first atomic bombs a few months later, work began in earnest to calculate a thermonuclear weapon. On March 11, 1947, John von Neumann sent a letter to Robert Richtmyer, leader of the Theoretical Division at Los Alamos, proposing use of the statistical method to solve neutron diffusion and multiplication problems in fission devices.<sup>10</sup> His letter was the first formulation of a Monte Carlo computation for an electronic computing machine. In 1947, while in Los Alamos, Fermi invented a mechanical device called FERMIAC<sup>11</sup> to trace neutron movements through fissionable materials by the Monte Carlo Method.

By 1948 Stan Ulam was able to report to the Atomic Energy Commission that not only was the Monte Carlo method being successfully used on problems pertaining to thermonuclear as well as fission devices, but also it was being applied to cosmic ray showers and the study of partial differential equations.<sup>10</sup> In the late 1940s and early 1950s, there was a surge of papers describing the Monte Carlo method and how it could solve problems in radiation or particle transport and other areas.<sup>12,13,14</sup> Many of the methods described in these papers are still used in Monte Carlo today, including the method of generating random numbers<sup>15</sup> used in MCNP. Much of the interest was based on continued development of computers such as the Los Alamos MANIAC (Mechanical Analyzer, Numerical Integrator, and Computer) in March, 1952.

The Atomic Energy Act of 1946 created the Atomic Energy Commission to succeed the Manhattan Project. In 1953 the United States embarked upon the “Atoms for Peace” program with the intent of developing nuclear energy for peaceful applications such as nuclear power generation. Meanwhile, computers were advancing rapidly. These factors led to greater interest in the Monte Carlo method. In 1954 the first comprehensive review of the Monte Carlo method was published by Herman Kahn<sup>16</sup> and the first book was published by Cashwell and Everett<sup>17</sup> in 1959.

At Los Alamos, Monte Carlo computer codes developed along with computers. The first Monte Carlo code was the simple 19–step computing sheet in John von Neumann's letter to Richtmyer. But as computers became more sophisticated, so did the codes. At first the codes were written in machine language and each code would solve a specific problem. In the early 1960s, better computers and the standardization of programming languages such as FORTRAN made possible more general codes. The first Los Alamos general–purpose particle transport Monte Carlo code was MCS,<sup>18</sup> written in 1963. Scientists who were not necessarily experts in computers and

## CHAPTER 2 INTRODUCTION

Monte Carlo mathematical techniques now could take advantage of the Monte Carlo method for radiation transport. They could run the MCS code to solve modest problems without having to do either the programming or the mathematical analysis themselves. MCS was followed by MCN<sup>19</sup> in 1965. MCN could solve the problem of neutrons interacting with matter in a three-dimensional geometry and used physics data stored in separate, highly-developed libraries.

In 1973 MCN was merged with MCG,<sup>20</sup> a Monte Carlo gamma code that treated higher energy photons, to form MCNG, a coupled neutron-gamma code. In 1977 MCNG was merged with MCP,<sup>20</sup> a Monte Carlo Photon code with detailed physics treatment down to 1 keV, to accurately model neutron-photon interactions. The code has been known as MCNP ever since. Though at first MCNP stood for Monte Carlo Neutron Photon, now it stands for Monte Carlo N-Particle. Other major advances in the 70s included the present generalized tally structure, automatic calculation of volumes, and a Monte Carlo eigenvalue algorithm to determine  $k_{eff}$  for nuclear criticality (KCODE).

In 1983 MCNP3 was released, entirely rewritten in ANSI standard FORTRAN 77. MCNP3 was the first MCNP version internationally distributed through the Radiation Shielding and Information Center at Oak Ridge, Tennessee. Other 1980s versions of MCNP were MCNP3A (1986) and MCNP3B (1988), that included tally plotting graphics (MCPLLOT), the present generalized source, surface sources, repeated structures/lattice geometries, and multigroup/adjoint transport.

MCNP4 was released in 1990 and was the first UNIX version of the code. It accommodated N-particle transport and multitasking on parallel computer architectures. MCNP4 added electron transport (patterned after the Integrated TIGER Series (ITS) continuous-slowing-down approximation physics),<sup>21</sup> the pulse height tally (F8), a thick-target bremsstrahlung approximation for photon transport, enabled detectors and DXTRAN with the  $S(\alpha,\beta)$  thermal treatment, provided greater random number control, and allowed plotting of tally results while the code was running.

MCNP4A, released in 1993, featured enhanced statistical analysis, distributed processor multitasking for running in parallel on a cluster of scientific workstations, new photon libraries, ENDF/B-VI capabilities, color X-Windows graphics, dynamic memory allocation, expanded criticality output, periodic boundaries, plotting of particle tracks via SABRINA, improved tallies in repeated structures, and many smaller improvements.

MCNP4B, released in 1997, featured differential operator perturbations, enhanced photon physics equivalent to ITS3.0, PVM load balance and fault tolerance, cross section plotting, postscript file plotting, 64-bit workstation upgrades, PC X-windows, inclusion of LAHET HMCNP, lattice universe mapping, enhanced neutron lifetimes, coincident-surface lattice capability, and many smaller features and improvements.

MCNP4C, released in 2000 features an unresolved resonance treatment, macrobodies, superimposed importance mesh, perturbation enhancements, electron physics enhancements, an alpha eigenvalue search, plotter upgrades, cumulative tallies, parallel enhancements and other small features and improvements.

Large production codes such as MCNP have revolutionized science — not only in the way it is done, but also by becoming the repositories for physics knowledge. MCNP represents about 500 person-years of sustained effort. The knowledge and expertise contained in MCNP is formidable.

Current MCNP development is characterized by a strong emphasis on quality control, documentation, and research. New features continue to be added to the code to reflect new advances in computer architecture, improvements in Monte Carlo methodology, and better physics models. MCNP has a proud history and a promising future.

### ***B. MCNP Structure***

MCNP is written in the style of Dr. Thomas N. K. Godfrey, the principal MCNP programmer from 1975–1989. Variable dimensions for arrays are achieved by massive use of EQUIVALENCE statements and offset indexing. All variables local to a routine are no more than two characters in length, and all COMMON variables are between three and six characters in length. The code strictly complies with the ANSI FORTRAN 77 standard. The principal characteristic of Tom Godfrey’s style is its terseness. Everything is accomplished in as few lines of code as possible. Thus MCNP does more than some other codes that are more than ten times larger. It was Godfrey’s philosophy that anyone can understand code at the highest level by making a flow chart and anyone can understand code at the lowest level (one FORTRAN line); it is the intermediate level that is most difficult. Consequently, by using a terse programming style, subroutines could fit within a few pages and be most easily understood. Tom Godfrey’s style is clearly counter to modern computer science programming philosophies, but it has served MCNP well and is preserved to provide stylistic consistency throughout.

The general structure of MCNP is as follows:

Initiation (IMCN):

- Read input file (INP) to get dimensions (PASS1);
- Set up variable dimensions or dynamically allocated storage (SETDAS);
- Re-read input file (INP) to load input (RDPROB);
- Process source (ISOURC);
- Process tallies (ITALLY);
- Process materials specifications (STUFF) including masses without loading the data files;
- Calculate cell volumes and surface areas (VOLUME).

## CHAPTER 2 INTRODUCTION

Interactive Geometry Plot (PLOT).

Cross Section Processing (XACT):

- Load libraries (GETXST);
- Eliminate excess neutron data outside problem energy range (EXPUNG);
- Doppler broaden elastic and total cross sections to the proper temperature if the problem temperature is higher than the library temperature (BROADN);
- Process multigroup libraries (MGXSPT);
- Process electron libraries (XSGEN) including calculation of range tables, straggling tables, scattering angle distributions, and bremsstrahlung.

MCRUN sets up multitasking and multiprocessing, runs histories (by calling TRNSPT, which calls HSTORY), and returns to OUTPUT to print, write RUNTPE dumps, or process another criticality (KCODE) cycle.

Under MCRUN, MCNP runs neutron, photon, or electron histories (HSTORY), calling ELECTR for electron tracks:

- Start a source particle (STARTP);
- Find the distance to the next boundary (TRACK), cross the surface (SURFAC) and enter the next cell (NEWCEL);
- Find the total neutron cross section (ACETOT) and process neutron collisions (COLIDN) producing photons as appropriate (ACEGAM);
- Find the total photon cross section (PHOTOT) and process photon collisions (COLIDP) producing electrons as appropriate (EMAKER);
- Use the optional thick-target bremsstrahlung approximation if no electron transport (TTBR);
- Follow electron tracks (ELECTR);
- Process optional multigroup collisions (MGCOLN, MGCOLP, MGACOL);
- Process detector tallies (TALLYD) or DXTRAN;
- Process surface, cell, and pulse height tallies (TALLY).

Periodically write output file, restart dumps, update to next criticality (KCODE) cycle, rendezvous for multitasking and updating detector and DXTRAN Russian roulette criteria, etc. (OUTPUT):

- Go to the next criticality cycle (KCALC);
- Print output file summary tables (SUMARY, ACTION);
- Print tallies (TALLYP);
- Generate weight windows (OUTWWG).

Plot tallies, cross sections, and other data (MC PLOT).

GKS graphics simulation routines.

PVM distributed processor multiprocessing routines.

Random number generator and control (RANDOM).

Mathematics, character manipulation, and other slave routines.

*C. History Flow*

The basic flow of a particle history for a coupled neutron/photon/electron problem is handled in subroutine HISTORY. HISTORY is called from TRNSPT after the random number sequence is set up and the number of the history, NPS, is incremented. The flow of HISTORY is then as follows.

First, STARTP is called. The flag IPT is set for the type of particle being run: 1 for a neutron, 2 for a photon, and 3 for an electron. Some arrays and variables (such as NBNK, the number of particles in the bank) are initialized to zero. The starting random number is saved (RANB, RANS, RNRTC0), and the branch of the history, NODE, is set to 1.

Next, the appropriate source routine is called. Source options are the standard fixed sources (SOURCB), the surface source (SURSRC), the KCODE criticality source (SOURCK), or a user-provided source (SOURCE). All of the parameters describing the particle are set in these source routines, including position, direction of flight, energy, weight, time, and starting cell (and possibly surface), by sampling the various distributions described on the source input control cards. Several checks are made at this time to verify that the particle is in the correct cell or on the correct surface, and directed toward the correct cell; then control is returned to STARTP.

Next in STARTP, the initial parameters of the first fifty particle histories are printed. Then some of the summary information is incremented (see Appendix E for an explanation of these arrays). Energy, time, and weight are checked against cutoffs. A number of error checks are made. TALLYD is called to score any detector contributions, and then DXTRAN is called (if used in the problem) to create particles on the spheres. The particles are saved with BANKIT for later tracking. TALPH is called to start the bookkeeping for the pulse height cell tally energy balance. The weight window game is played, with any additional particles from splitting put into the bank and any losses to Russian roulette terminated. Control is returned to HISTORY.

Back in HISTORY, the actual particle transport is started. For an electron source, ELECTR is called and electrons are run separately. For a neutron or photon source, TRACK is called to calculate the intersection of the particle trajectory with each bounding surface of the cell. The minimum positive distance DLS to the cell boundary indicates the next surface JSU the particle is heading toward. The distance to the nearest DXTRAN sphere DXL is calculated, as is the distance to time cutoff DTC, and energy boundary for multigroup charged particles DEB. The cross sections for cell ICL are calculated using a binary table lookup in ACETOT for neutrons and in PHOTOT for photons. The total cross section is modified in EXTRAN by the exponential transformation if necessary. The distance PMF to the next collision is determined (if a forced collision is required, FORCOL is called and the uncollided part is banked). The track length D of the particle in the cell is found as the minimum of the distance PMF to collision, the distance DLS to the surface JSU, the distance DXL to a DXTRAN sphere, the distance DTC to time cutoff, or the distance DEB to energy boundary. TALLY then is called to increment any track

## CHAPTER 2 INTRODUCTION

length cell tallies. Some summary information is incremented. The particle's parameters (time, position, and energy) are then updated. If the particle's distance DXL to a DXTRAN sphere (of the same type as the current particle) is equal to the minimum track length D, the particle is terminated because particles reaching the DXTRAN sphere are already accounted for by the DXTRAN particles from each collision. If the particle exceeds the time cutoff, the track is terminated. If the particle was detected leaving a DXTRAN sphere, the DXTRAN flag IDX is set to zero and the weight cutoff game is played. The particle is either terminated to weight cutoff or survives with an increased weight. Weight adjustments then are made for the exponential transformation.

If the minimum track length D is equal to the distance-to-surface crossing DLS, the particle is transported distance D to surface JSU and SURFAC is called to cross the surface and do any surface tallies (by calling TALLY) and to process the particle across the surface into the next cell by calling NEWCEL. It is in SURFAC that reflecting surfaces, periodic boundaries, geometry splitting, Russian roulette from importance sampling, and loss to escape are treated. For splitting, one bank entry of NPA particle tracks is made in BANKIT for an (NPA+1)-for-1 split. The bank is the IBNK array, and entries or retrievals are made with the GPBLCM and JPBLCM arrays (the bank operates strictly on a last-in, first-out basis). The history is continued by going back to HISTORY and calling TRACK.

If the distance to collision PMF is less than the distance to surface DLS, or if a multigroup charged particle reaches the distance to energy boundary DEB, the particle undergoes a collision. Everything about the collision is determined in COLIDN for neutrons and COLIDP for photons. COLIDN determines which nuclide is involved in the collision, samples the target velocity of the collision nuclide by calling TGTVEL for the free gas thermal treatment, generates and banks any photons (ACEGAM), handles analog capture or capture by weight reduction, plays the weight cutoff game, handles  $s(\alpha, \beta)$  thermal collisions (SABCOL) and elastic or inelastic scattering (ACECOL). For criticality problems, COLIDK is called to store fission sites for subsequent generations. Any additional tracks generated in the collision are put in the bank. ACECAS and ACECOS determine the energies and directions of particles exiting the collision. Multigroup and multigroup/adjoint collisions are treated separately in MGCOLN and MGACOL that are called from COLIDN. The collision process and thermal treatments are described in more detail later in this chapter (see page 2–28).

COLIDP for photons is similar to COLIDN, and it covers the simple or the detailed physics treatments. The simple physics treatment is better for free electrons; the detailed treatment is the default and includes form factors for electron binding effects, coherent (Thomson) scatter, and fluorescence from photoelectric capture (see page 2–55). COLIDP samples for the collision nuclide, treats photoelectric absorption, or capture (with fluorescence in the detailed physics treatment), incoherent (Compton) scatter (with form factors in the detailed physics treatment to account for electron binding), coherent (Thomson) scatter for the detailed physics treatment only (again with form factors), and pair production. Electrons are generated (EMAKER) for

incoherent scatter, pair production, and photoelectric absorption. These electrons may be assumed to deposit all their energy instantly if IDES=1 on the PHYS:P card, or they may produce electrons with the thick-target bremsstrahlung approximation (default for MODE P problems, IDES=0 on the PHYS:P card), or they may undergo full electron transport (default for MODE P E problems, IDES=0 on the PHYS:P card.) Multigroup or multigroup/adjoint photons are treated separately in MGCOLP or MGACOL.

After the surface crossing or collision is processed, control returns to HISTORY and transport continues by calling TRACK, where the distance to cell boundary is calculated. Or if the particle involved in the collision was killed by capture or variance reduction, the bank is checked for any remaining progeny, and if none exists, the history is terminated. Appropriate summary information is incremented, the tallies of this particular history are added to the total tally data by TALSHF, and a return is made to TRNSPT.

In TRNSPT, checks are made to see if output is required or if the job should be terminated because enough histories have been run or too little time remains to continue. For continuation, HISTORY is called again. Otherwise a return is made to MCRUN. MCRUN calls OUTPUT, which calls SUMARY to print the summary information. Then SUMARY calls TALLYP to print the tally data. Appendix E defines all of the MCNP variables that are in COMMON as well as detailed descriptions of some important arrays.

## ***II. GEOMETRY***

The basic MCNP geometry concepts, discussed in Chapter 1, include the sense of a cell, the intersection and union operators, and surface specification. Covered in this section are the complement operator; the repeated structure capability; an explanation of two surfaces, the cone and the torus; and a description of ambiguity, reflecting, white, and periodic boundary surfaces.

### ***A. Complement Operator***

This operator provides no new capability over the intersection and union operators; it is just a shorthand cell-specifying method that implicitly uses the intersection and union operators.

The symbol # is the complement operator and can be thought of as standing for *not in*. There are two basic uses of the operator:

- #*n* means that the description of the current cell is the complement of the description of cell *n*.
- #(...) means complement the portion of the cell description in the parentheses (usually just a list of surfaces describing another cell).

In the first of the two above forms, MCNP performs five operations: (1) the symbol # is removed, (2) parentheses are placed around *n*, (3) any intersections in *n* become unions, (4) any unions in



## CHAPTER 2 GEOMETRY

$n$  are replaced by back-to-back parentheses, “)(“, which is an intersection, and (5) the senses of the surfaces defining  $n$  are reversed.

A simple example is a cube. We define a two-cell geometry with six surfaces, where cell 1 is the cube and cell 2 is the outside world:

```
1  0 -1 2 -3 4 -5 6
2  0 1:-2: 3:-4: 5:-6
```

Note that cell 2 is everything in the universe that is *not in* cell 1, or

```
2  0 #1
```

The form  $\#(n)$  is not allowed; it is functionally available as the equivalent of  $-n$ .

**CAUTION:** Using the complement operator can destroy some of the necessary conditions for some cell volume and surface area calculations by MCNP. See page 4–15 for an example.

The complement operator can be easily abused if it is used indiscriminately. A simple example can best illustrate the problems. Fig. 2-1 consists of two concentric spheres inside a box. Cell 4 can be described using the complement operator as

```
4  0 #3 #2 #1
```

Although cells 1 and 2 do not touch cell 4, to omit them would be incorrect. If they were omitted, the description of cell 4 would be everything in the universe that is not in cell 3. Since cells 1 and 2 are not part of cell 3, they would be included in cell 4. Even though surfaces 1 and 2 do not physically bound cell 4, using the complement operator as in this example causes MCNP to think that all surfaces involved with the complement do bound the cell. Even though this specification is correct and required by MCNP, the disadvantage is that when a particle enters cell 4 or has a collision in cell 4, MCNP must calculate the intersection of the particle's trajectory with all real bounding surfaces of cell 4 plus any extraneous ones brought in by the complement operator. This intersection calculation is very expensive and can add significantly to the required computer time.

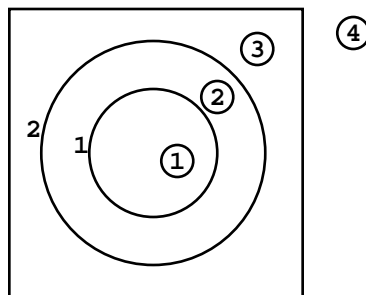

**Figure 2-1.**

A better description of cell 4 would be to complement the description of cell 3 (omitting surface 2) by reversing the senses and interchanging union and intersection operators as illustrated in the cell cards that describe the simple cube in the preceding paragraphs.

### ***B. Repeated Structure Geometry***

The repeated structure geometry feature is explained in detail starting on page 3–25. The capabilities are only introduced here. Examples are shown in Chapter 4. The cards associated with the repeated structure feature are U (universe), FILL, TRCL, and LAT (lattice) and cell cards with LIKE m BUT.

The repeated structure feature makes it possible to describe only once the cells and surfaces of any structure that appears more than once in a geometry. This unit then can be replicated at other xyz locations by using the “LIKE m BUT” construct on a cell card. The user specifies that a cell is filled with something called a universe. The U card identifies the universe, if any, to which a cell belongs. The FILL card specifies with which universe a cell is to be filled. A universe is either a lattice or an arbitrary collection of cells. The two types of lattice shapes, hexagonal prisms and hexahedra, need not be rectangular nor regular, but they must fill space exactly. Several concepts and cards combine in order to use this capability.

### ***C. Surfaces***

#### **1. Explanation of Cone and Torus**

Two surfaces, the cone and torus, require more explanation. The quadratic equation for a cone describes a cone of two sheets (just like a hyperboloid of two sheets)—one sheet is a cone of positive slope, and the other has a negative slope. A cell whose description contains a two-sheeted cone may require an ambiguity surface to distinguish between the two sheets. MCNP provides the option to select either of the two sheets; this option frequently simplifies geometry setups and eliminates any ambiguity. The +1 or the –1 entry on the cone surface card causes the one sheet cone treatment to be used. If the sign of the entry is positive, the specified sheet is the one that extends to infinity in the positive direction of the coordinate axis to which the cone axis is parallel. The converse is true for a negative entry. This feature is available only for cones whose axes are parallel to the coordinate axes of the problem.

The treatment of fourth degree surfaces in Monte Carlo calculations has always been difficult because of the resulting fourth order polynomial (“quartic”) equations. These equations must be solved to find the intersection of a particle’s line of flight with a toroidal surface. In MCNP these equations must also be solved to find the intersection of surfaces in order to compute the volumes and surface areas of geometric regions of a given problem. In either case, the quartic equation,

## CHAPTER 2 GEOMETRY

$$x^4 + Bx^3 + Cx^2 + Dx + E = 0$$

is difficult to solve on a computer because of roundoff errors. For many years the MCNP toroidal treatment required 30 decimal digits (CDC double-precision) accuracy to solve quartic equations. Even then there were roundoff errors that had to be corrected by Newton-Raphson iterations. Schemes using a single-precision quartic formula solver followed by a Newton-Raphson iteration were inadequate because if the initial guess of roots supplied to the Newton-Raphson iteration is too inaccurate, the iteration will often diverge when the roots are close together.

The single-precision quartic algorithm in MCNP basically follows the quartic solution of Cashwell and Everett.<sup>22</sup> When roots of the quartic equation are well separated, a modified Newton-Raphson iteration quickly achieves convergence. But the key to this method is that if the roots are double roots or very close together, they are simply thrown out because a double root corresponds to a particle's trajectory being tangent to a toroidal surface, and it is a very good approximation to assume that the particle then has no contact with the toroidal surface. In extraordinarily rare cases where this is not a good assumption, the particle would become "lost." Additional refinements to the quartic solver include a carefully selected finite size of zero, the use of a cubic rather than a quartic equation solver whenever a particle is transported from the surface of a torus, and a gross quartic coefficient check to ascertain the existence of any real positive roots. As a result, the single-precision quartic solver is substantially faster than double-precision schemes, portable, and also somewhat more accurate.

In MCNP, elliptical tori symmetric about any axis parallel to a coordinate axis may be specified. The volume and surface area of various tallying segments of a torus usually will be calculated automatically.

### 2. Ambiguity Surfaces

The description of the geometry of a cell must eliminate any ambiguities as to which region of space is included in the cell. That is, a particle entering a cell should be able to determine uniquely which cell it is in from the senses of the bounding surfaces. This is not possible in a geometry such as shown in Fig. 2-2 unless an *ambiguity surface* is specified. Suppose the figure is rotationally symmetric about the y-axis.

A particle entering cell 2 from the inner spherical region might think it was entering cell 1 because a test of the senses of its coordinates would satisfy the description of cell 1 as well as that of cell 2. In such cases, an ambiguity surface is introduced such as *a*, the plane  $y = 0$ . An ambiguity surface need not be a bounding surface of a cell, but it may be and frequently is. It can also be the bounding surface of some cell other than the one in question. However, the surface must be listed among those in the problem and must not be a reflecting surface (see page 2-14). The description of cells 1 and 2 in Fig. 2-2 is augmented by listing for each its sense

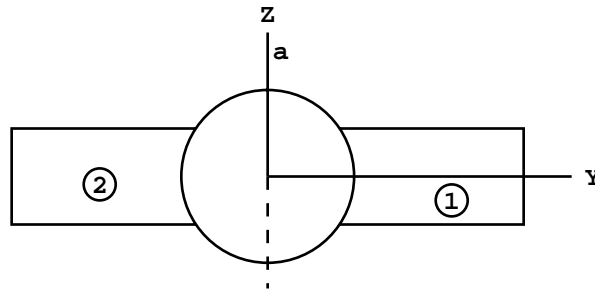

Figure 2-2.

relative to surface  $a$  as well as that of each of its other bounding surfaces. A particle in cell 1 cannot have the same sense relative to surface  $a$  as does a particle in cell 2. More than one ambiguity surface may be required to define a particular cell.

A second example may help to clarify the significance of ambiguity surfaces. We would like to describe the geometry of Fig. 2-3a. Without the use of an ambiguity surface, the result will be Fig. 2-3b. Surfaces 1 and 3 are spheres about the origin, and surface 2 is a cylinder around the  $y$ -axis. Cell 1 is both the center and outside world of the geometry connected by the region interior to surface 2.

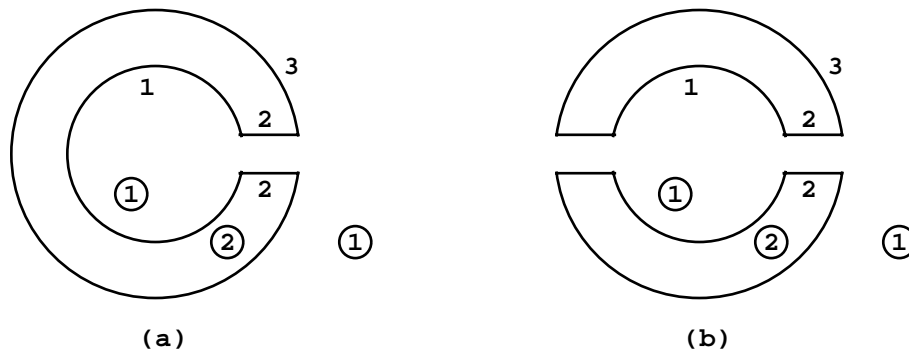

Figure 2-3.

At first glance it may appear that cell 1 can easily be specified by  $-1 : -2 : 3$  whereas cell 2 is simply #1. This results in Figure 2.3b, in which cell 1 is everything in the universe interior to surface 1 plus everything in the universe interior to surface 2 (remember the cylinder goes to plus and minus infinity) plus everything in the universe exterior to surface 3.

An ambiguity surface (a plane at  $y=0$ ) will solve the problem. Everything in the universe to the right of the ambiguity surface (call it surface 4) *intersected* with everything in the universe

## CHAPTER 2 GEOMETRY

interior to the cylinder is a cylindrical region that goes to plus infinity but terminates at  $y=0$ . Therefore,  $-1 : (4 - 2) : 3$  defines cell 1 as desired in Figure 2.3a. The parentheses in this last expression are not required because intersections are done before unions. Another expression for cell 2 rather than #1 is  $1 - 3 \#(4 - 2)$ .

For the user, ambiguity surfaces are specified the same way as any other surface—simply list the signed surface number as an entry on the cell card. For MCNP, if a particular ambiguity surface appears on cell cards with only one sense, it is treated as a true ambiguity surface. Otherwise, it still functions as an ambiguity surface but the TRACK subroutine will try to find intersections with it, thereby using a little more computer time.

### 3. Reflecting Surfaces

A surface can be designated a reflecting surface by preceding its number on the surface card with an asterisk. Any particle hitting a reflecting surface is specularly (mirror) reflected. Reflecting planes are valuable because they can simplify a geometry setup (and also tracking) in a problem. They can, however, make it difficult (or even impossible) to get the correct answer. The user is cautioned to check the source weight and tallies to ensure that the desired result is achieved. Any tally in a problem with reflecting planes should have the same expected result as the tally in the same problem without reflecting planes. Detectors or DXTRAN used with reflecting surfaces give WRONG answers (see page 2–92).

The following example illustrates the above points and hopefully makes you very cautious in the use of reflecting surfaces; they should never be used in any situation without a lot of thought.

Consider a cube of carbon 10 cm on a side sitting on top of a 5-MeV neutron source distributed uniformly in volume. The source cell is a 1-cm-thick void completely covering the bottom of the carbon cube and no more. The average neutron flux across any one of the sides (but not top or bottom) is calculated to be  $0.150 (\pm 0.5\%)$  per  $\text{cm}^2$  per starting neutron from an MCNP F2 tally, and the flux at a point at the center of the same side is  $1.55\text{e-}03 \text{ n/cm}^2 (\pm 1\%)$  from an MCNP F5 tally.

The cube can be modeled by half a cube and a reflecting surface. All dimensions remain the same except the distance from the tally surface to the opposite surface (which becomes the reflecting surface) is 5 cm. The source cell is cut in half also. Without any source normalization, the flux across the surface is now  $0.302 (\pm 0.5\%)$ , which is twice the flux in the nonreflecting geometry. The detector flux is  $2.58\text{E-}03 (\pm 1\%)$ , which is *less* than twice the point detector flux in the nonreflecting problem.

The problem is that for the surface tally to be correct, the starting weight of the source particles has to be normalized; it should be half the weight of the nonreflected source particles. The detector results will always be wrong (and lower) for the reason discussed on page 2–92.

In this particular example, the normalization factor for the starting weight of source particles should be 0.5 because the source volume is half of the original volume. Without the normalization, the full weight of source particles is started in only half the volume. These normalization factors are problem dependent and should be derived very carefully.

Another way to view this problem is that the tally surface has doubled because of the reflecting surface; two scores are being made across the tally surface when one is made across each of two opposite surfaces in the nonreflecting problem. The detector has doubled too, except that the contributions to it from beyond the reflecting surface are not being made, see page 2–92.

#### 4. White Boundaries

A surface can be designated a white boundary surface by preceding its number on the surface card with a plus. A particle hitting a white boundary is reflected with a cosine distribution,  $p(\mu) = \mu$ , relative to the surface normal; that is,  $\mu = \sqrt{\xi}$ , where  $\xi$  is a random number. White boundary surfaces are useful for comparing MCNP results with other codes that have white boundary conditions. They also can be used to approximate a boundary with an infinite scatterer. They make absolutely no sense in problems with next-event estimators such as detectors or DXTRAN (see page 2–92) and should always be used with caution.

#### 5. Periodic Boundaries

Periodic boundary conditions can be applied to pairs of planes to simulate an infinite lattice. Although the same effect can be achieved with an infinite lattice, the periodic boundary is easier to use, simplifies comparison with other codes having periodic boundaries, and can save considerable computation time. There is approximately a 55% run-time penalty associated with repeated structures and lattices that can be avoided with periodic boundaries. However, collisions and other aspects of the Monte Carlo random walk usually dominate running time, so the savings realized by using periodic boundaries are usually much smaller. A simple periodic boundary problem is illustrated in Figure 2.3c.

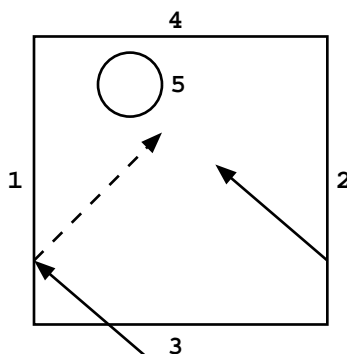

**Figure 2-3(c).**

## CHAPTER 2 CROSS SECTIONS

It consists of a square reactor lattice infinite in the z direction and 10 cm on a side in the x and y directions with an off-center 1 cm–radius cylindrical fuel pin. The MCNP surface cards are:

1	-2	px	-5			
2	-1	px	5			
3	-4	py	-5			
4	-3	py	5			
5		c/z	-2	4	1	

The negative entries before the surface mnemonics specify periodic boundaries. Card one says that surface 1 is periodic with surface 2 and is a px plane. Card two says that surface 2 is periodic with surface 1 and is a px plane. Card three says that surface 3 is periodic with surface 4 and is a py plane. Card four says that surface 4 is periodic with surface 3 and is a py plane. Card five says that surface 5 is an infinite cylinder parallel to the z–axis. A particle leaving the lattice out the left side (surface 1) re-enters on the right side (surface 2). If the surfaces were reflecting, the re-entering particle would miss the cylinder, shown by the dotted line. In a fully specified lattice and in the periodic geometry, the re-entering particle will hit the cylinder as it should.

Much more complicated examples are possible, particularly hexagonal prism lattices. In all cases, MCNP checks that the periodic surface pair matches properly and performs all the necessary surface rotations and translations to put the particle in the proper place on the corresponding periodic plane.

The following limitations apply:

- Periodic boundaries cannot be used with next event estimators such as detectors or DXTRAN (see page 2–92);
- All periodic surfaces must be planes;
- Periodic planes cannot also have a surface transformation;
- The periodic cells may be infinite or bounded by planes on the top or bottom that must be reflecting or white boundaries but not periodic;
- Periodic planes can only bound other periodic planes or top and bottom planes;
- A single zero-importance cell must be on one side of each periodic plane;
- All periodic planes must have a common rotational vector normal to the geometry top and bottom.

### ***III. CROSS SECTIONS***

The MCNP code package is incomplete without the associated nuclear data tables. The kinds of tables available and their general features are outlined in this section. The manner in which information contained on nuclear data tables is used in MCNP is described in Sec. IV of this chapter.

There are two broad objectives in preparing nuclear data tables for MCNP. First, it is our responsibility to ensure that the data available to MCNP reproduce the original evaluated data as much as is practical. Second, new data should be brought into the MCNP package in a timely fashion, thereby giving users access to the most recent evaluations.

Eight classes of nuclear data tables exist for MCNP. They are: (1) continuous-energy neutron interaction data, (2) discrete reaction neutron interaction data, (3) photon interaction data, (4) neutron dosimetry cross sections, (5) neutron  $S(\alpha,\beta)$  thermal data (6) multigroup neutron, coupled neutron/photon, and charged particles masquerading as neutrons, (7) multigroup photon, and (8) electron interaction data. It is understood that photon and electron data are atomic rather than nuclear. In Mode N problems, one continuous-energy or discrete-reaction neutron interaction table is required for each isotope or element in the problem. Likewise, one photon interaction table is required for each element in a Mode P problem, and one electron interaction table is required for each element in a Mode E problem. Dosimetry and thermal data are optional. Cross sections from dosimetry tables can be used as response functions with the FM card to determine reaction rates. Thermal  $S(\alpha,\beta)$  tables are appropriate if the neutrons are transported at sufficiently low energies where molecular binding effects are important.

MCNP can read from data tables in two formats. Data tables are transmitted between computer installations in 80-column card-image BCD format (Type-1 format). An auxiliary processing code, MAKXSF, converts the BCD files to standard unformatted binary files (Type-2 format), allowing more economical access during execution of MCNP. The data contained on a table for a specific ZAID (10-character name for a nuclear data table) are independent of the format of the table.

The format of nuclear data tables is given in considerable detail in Appendix F. This appendix may be useful for users making extensive modifications to MCNP involving cross sections or for users debugging MCNP at a fairly high level.

The available nuclear data tables are listed in Appendix G. Each nuclear data table is identified by a ZAID. The general form of a ZAID is ZZZAAA.nnX, where ZZZ is the atomic number, AAA is the atomic weight, nn is the evaluation identifier, and X indicates the class of data. For elemental evaluations AAA=000. Nuclear data tables are selected by the user with the Mn and MTn cards.

In the remainder of this section we describe several characteristics of each class of data such as evaluated sources, processing tools, and any differences between data on the original evaluation and on the MCNP data tables. The means of accessing each class of data through MCNP input will be detailed and some hints will be provided on how to select the appropriate data tables.



## CHAPTER 2 CROSS SECTIONS

### A. *Neutron Interaction Data: Continuous-Energy and Discrete-Reaction*

In neutron problems, one neutron interaction table is required for each isotope or element in the problem. The form of the ZAIDs is ZZZAAA.nnC for a continuous-energy table and ZZZAAA.nnD for a discrete reaction table. The neutron interaction tables available to MCNP are listed in Table G.2 of Appendix G. (It should be noted that although all nuclear data tables in Appendix G are available to users at Los Alamos, users at other installations will generally have only a subset of the tables available.)

For most materials there are many cross-section sets available (represented by different values of nn in the ZAIDs) because of multiple sources of evaluated data and different parameters used in processing the data. An evaluated nuclear data set is produced by analyzing experimentally measured cross sections and combining those data with the predictions of nuclear model calculations in an attempt to extract the most accurate cross-section information. Preparing evaluated cross-section sets has become a discipline in itself and has developed since the early 1960s. People in most of the national laboratories and several of the commercial reactor design firms are involved in such work. American evaluators joined forces in the mid-1960s to create the national ENDF system.<sup>23</sup> The ENDF contributors collaborate through the Cross Section Evaluation Working Group (CSEWG).

In recent years the primary evaluated source of neutron interaction data for MCNP has been the ENDF/B system. Recently evaluated neutron interaction data tables are also extracted from two other sources: Lawrence Livermore National Laboratory's Evaluated Nuclear Data Library (ENDL),<sup>24</sup> and supplemental evaluations performed in the Nuclear Theory and Applications Group at Los Alamos.<sup>25,26,27</sup> Older evaluations come from previous versions of ENDF/B and ENDL, the Los Alamos Master Data File,<sup>28</sup> and the Atomic Weapons Research Establishment in Great Britain.

MCNP does not access evaluated data directly; these data must first be processed into ACE format. The very complex processing codes used for this purpose include NJOY<sup>29</sup> for evaluated data in ENDF/B format and MCPOINT<sup>30</sup> for ENDL data.

Data on the MCNP neutron interaction tables include cross sections and much more. Cross sections for all reactions given in the evaluated data are specified. For a particular table, the cross sections for each reaction are given on one energy grid that is sufficiently dense that linear-linear interpolation between points reproduces the evaluated cross sections within a specified tolerance that is generally 1% or less. Depending primarily on the number of resolved resonances for each isotope, the resulting energy grid may contain as few as ~250 points (for example, H-1) or as many as ~22,500 points (for example, the ENDF/B-V version of AU-197). Other information, including the total absorption cross section, the total photon production cross section, and the average heating number (for energy deposition calculations), is also tabulated on the same energy grid.

Angular distributions of scattered neutrons are included in the neutron interaction tables for all reactions emitting neutrons. The distributions are given in the center-of-mass system for elastic scattering, discrete-level inelastic scattering, and for some ENDF/B-VI scattering laws, and are given in the laboratory system for all other inelastic reactions. Angular distributions are given on a reaction-dependent grid of incident neutron energies. These tables are sampled to conserve energy for many collisions but will not necessarily conserve energy for a single collision; that is, energy is conserved on average.

The sampled angle of scattering uniquely determines the secondary energy for elastic scattering and discrete-level inelastic scattering. For other inelastic reactions, energy distributions of the scattered neutrons are provided in the neutron interaction tables. As with angular distributions, the energy distributions are given on a reaction-dependent grid of incident neutron energies.

When evaluations contain data about secondary photon production, that information appears in the MCNP neutron interaction tables. Many processed data sets contain photon production cross sections, photon angular distributions, and photon energy distributions for each neutron reaction that produces secondary photons. The information is given in a manner similar to that described in the last few paragraphs for neutron cross sections and secondary neutron distributions.

Other miscellaneous information on the neutron interaction tables includes the atomic weight ratio of the target nucleus, the Q-values of each reaction, and nubar,  $\bar{\nu}$ , data (the average number of neutrons per fission) for fissionable isotopes. In many cases both prompt and total  $\bar{\nu}$  are given. Prompt  $\bar{\nu}$  is the default for all but KCODE criticality problems and total  $\bar{\nu}$  is the default for KCODE criticality problems. The TOTNU input card can be used to change the default.

Approximations must be made when processing an evaluated data set into ACE format. As mentioned above, cross sections are reproduced only within a certain tolerance, generally  $< 1\%$ ; to decrease it further would result in excessively large data tables. For many nuclides, a “thinned” neutron interaction table is available with a coarse tolerance,  $> 1\%$ , that greatly reduces the library size. Smaller library sizes also can be obtained by using discrete reaction tables or higher temperature data. Evaluated angular distributions for secondary neutrons and photons are approximated on MCNP data tables by 32 equally probable cosine bins. This approximation is clearly necessary when contrasted to the alternative that might involve sampling from a 20th-order Legendre polynomial distribution. Secondary neutron energy distributions given in tabular form by evaluators are sometimes approximated on MCNP data tables by 32 equally probable energy bins. Older cross-section tables include a 30x20 matrix approximation of the secondary photon energy spectra (described on page 2–34). On the whole, the approximations are small, and MCNP neutron interaction data tables are extremely faithful representations of evaluated data.

Discrete-reaction tables are identical to continuous-energy tables except that in the discrete reaction tables all cross sections have been averaged into 262 groups. The averaging is done with

## CHAPTER 2 CROSS SECTIONS

a flat weighting function. This is not a multigroup representation; the cross sections are simply given as histograms rather than as continuous curves. The remaining data (angular distributions, energy distributions,  $\bar{v}$ , etc.) are identical in discrete-reaction and continuous-energy tables. Discrete-reaction tables are provided primarily as a method of shrinking the required data storage to enhance the ability to run MCNP on small machines or in a time-sharing environment. The tables may also be useful for preliminary scoping studies or for isotopes that exist only in trace quantities in a problem. They are not, however, recommended as a substitute for the continuous-energy tables when performing final calculations, particularly for problems involving transport through the resonance region.

The matter of how to select the appropriate neutron interaction tables for your calculation is now discussed. Multiple tables for the same isotope are differentiated by the “nn” portion of the ZAID. The easiest choice for the user, although by no means the recommended one, is not to enter the nn at all. MCNP will select the first match found in the directory file XSDIR. The default nnX can be changed for all isotopes of a material by the NLIB keyword entry on the Mm card. The default will be overridden by fully specifying the ZAID. Default continuous-energy neutron interaction tables are accessed by entering ZZZAAA for the ZAID\ null. Including a DRXS card in the input file will force MCNP to choose the default discrete reaction tables.

Careful users will want to think about what neutron interaction tables to choose. There is, unfortunately, no strict formula for choosing the tables. The following guidelines and observations are the best that can be offered:

1. Users should be aware of the differences between the “.50C” series of data tables and the “.51C” series. Both are derived from ENDF/B-V. The “.50C” series is the most faithful reproduction of the evaluated data. The “.51C” series, also called the “thinned” series, has been processed with a less rigid tolerance than the “.50C” series. As with discrete reaction data tables, although by no means to the same extent, users should be careful when using the “thinned” data for transport through the resonance region.
2. Consider differences in evaluators' philosophies. The Physical Data Group at Livermore is justly proud of its extensive cross-section efforts; their evaluations manifest a philosophy of reproducing the data with the fewest number of points. Livermore evaluations are available mainly in the “.40C” series. We at Los Alamos are particularly proud of the evaluation work being carried out in the Nuclear Theory and Applications Group T-2; generally, these evaluations are the most complex because they are the most thorough. Recent evaluations from Los Alamos are available in the “.55C” series.
3. Be aware of the neutron energy spectrum in your problem. For high-energy problems, the “thinned” and discrete reaction data are probably not bad approximations.

Conversely, it is essential to use the most detailed continuous-energy set available for problems influenced strongly by transport through the resonance region.

4. Check the temperature at which various data tables have been processed. Do not use a set that is Doppler broadened to 12,000,000 ° K for a room temperature calculation.
5. Consider checking the sensitivity of the results to various sets of nuclear data. Try, for example, a calculation with ENDF/B-V cross sections, and then another with ENDL cross sections. If the results of a problem are extremely sensitive to the choice of nuclear data, it is advisable to find out why.
6. For a coupled neutron/photon problem, be careful that the tables you choose have photon production data available. If possible, use the more-recent sets that have been processed into expanded photon production format.
7. In general, use the best data you can afford. It is understood that the latest evaluations tend to be more complex and therefore require more memory and longer execution times. If you are limited by available memory, try to use smaller data tables such as thinned or discrete-reaction for the minor isotopes in the calculation. Discrete reaction data tables might be used for a parameter study, followed by a calculation with the full continuous-energy data tables for confirmation.

To select the neutron interaction data tables, the nn portion of the ZAIDs must be entered on the Mn card(s). For a continuous-energy set, ZZZAAA.nn is equivalent to ZZZAAA.nnC. To use a discrete-reaction table (unless there is a DRXS card in the input) the full ZAID, ZZZAAA.nnD, must be entered.

If only the integer portion of the ZAID is entered (ZZZAAA), MCNP will choose the cross-section table that it will use. Based on other cards (i.e., MODE, MGOPT, DRXS), MCNP knows which class of data is required. The code then “reads” the cross-section directory file (XSDIR) and selects the first table it finds that meets the ZZZAAA and class criteria. Thus, default cross sections are based entirely on the ordering of the entries in the XSDIR file you are using at your installation.

In conclusion, the additional time necessary to choose appropriate neutron interaction data tables rather than simply to accept the defaults often will be rewarded by increased understanding of your calculation.

### ***B. Photon Interaction Data***

Photon interaction cross sections are required for all photon problems. The form of the ZAID is ZZZ000.nnP. There are two photon interaction data libraries: nn = 01 and nn = 02.

For the ZAID=ZZZ000.01P library, the photon interaction tables for Z = 84, 85, 87, 88, 89, 91, and 93 are based on the compilation of Storm and Israel<sup>31</sup> from 1 keV to 15 MeV. For all other

## CHAPTER 2 CROSS SECTIONS

elements from  $Z = 1$  through  $Z = 94$  the photon interaction tables are based on evaluated data from ENDF<sup>32</sup> from 1 keV to 100 MeV. Fluorescence data are taken from work by Everett and Cashwell.<sup>33</sup> Energy grids are tailored specifically for each element and contain approximately 40 to 60 points.

The Z Aid = ZZZ000.02P library is a superset of the Z Aid = ZZZ000.01P library with pair production thresholds added for the Storm-Israel data. Data above 15 MeV for the Storm-Israel data and above 100 MeV for the ENDF data come from adaptation of the Livermore Evaluated Photon Data Library (EPDL)<sup>34</sup> and go up to 100 GeV. However, it usually is impractical to run above 1 GeV with MCNP because electron data only go to 1 GeV. The energy grid for the Z Aid = ZZZ000.02P library contains approximately 100 points.

For each nuclide the photon interaction libraries contain an energy grid (logarithms of energies), including the photoelectric edges and the pair production threshold. These energies are tailored specifically for each element. The logarithmic energies are followed by tables of incoherent and coherent form factors that are tabulated as a function of momentum transfer. The next tables are logarithms of the incoherent scattering, coherent scattering, photoelectric, and pair production cross sections, followed by the photon heating numbers. The total cross section is not stored, but rather summed from the other cross sections during transport.

The determination of directions and energies of scattered photons requires information different from the sets of angular and energy distributions found on neutron interaction tables. Angular distributions of secondary photons are isotropic for photoelectric effect, fluorescence, and pair production, and come from sampling the well-known Thomson and Klein-Nishina formulas for coherent and incoherent scattering. The energy of an incoherently scattered photon is calculated from the sampled scattering angle. Values of the integrated coherent form factor are tabulated on the photon interaction tables for use with next event estimators such as point detectors.

Very few approximations are made in the various processing codes used to transfer photon data from ENDF into the format of MCNP photon interaction tables. Cross sections are reproduced exactly as given. Form factors and scattering functions are reproduced as given; however, the momentum transfer grid on which they are tabulated may be different from that of the original evaluation. Heating numbers are calculated values, not given in evaluated sets, but inferred from them. Fluorescence data are not provided in ENDF; therefore the data for MCNP are extracted from a variety of sources as described in Ref. 31.

To select photon interaction data, specific Z Aid identifiers can be used, such as Z Aid = ZZZ000.02P, or selections from a library can be used by specifying PLIB=nnP on the M card. The PLIB = specification on the M card is the preferred method because the Z Aid entries may already be used to specify neutron libraries and, unlike neutrons, it usually is desirable to pick all photon data from the same library. A specification on the Mn card for a neutron interaction table with Z Aid = ZZZAAA.nnC or Z Aid = ZZZAAA.nnD immediately

causes a photon interaction table with ZAID = ZZZ000.nnP to be accessed as well, where nn is the first photon data encountered for ZZZ000 on the XSDIR cross section directory file or nn comes from PLIB = nn. The data table required for ZAID = ZZZAAA.nnP is identical to that required for ZAID = ZZZ000.nnP; however, the atomic weight used in the calculation will likely be different.

### ***C. Electron Interaction Data***

Electron interaction data tables are required both for problems in which electrons are actually transported, and for photon problems in which the thick-target bremsstrahlung model is used. Electron data tables are identified by ZAIDs of the form ZZZ000.nnE, and are selected by default when the problem mode requires them. There are two electron interaction data libraries: nn=03 and nn = 01.

The electron library contains data on an element-by-element basis for atomic numbers Z=1–94. As is the case with photons, there is no distinction between isotopes for a given element. The library data contain energies for tabulation, radiative stopping power parameters, bremsstrahlung production cross sections, bremsstrahlung energy distributions, K-edge energies, Auger electron production energies, parameters for the evaluation of the Goudsmit-Saunderson theory for angular deflections based on the Riley cross section calculation, and Mott correction factors to the Rutherford cross sections also used in the Goudsmit-Saunderson theory. The eI03 database also includes the atomic data of Carlson used in the density effect calculation. Internally, calculated data are electron stopping powers and ranges, K x-ray production probabilities, knock-on probabilities, bremsstrahlung angular distributions, and the Landau-Blunck-Leisegang theory of energy-loss fluctuations. The eI03 evaluation is derived from the ITS3.0 code system.<sup>35</sup> Discussions of the theoretical basis for these data and references to the relevant literature are presented in Section IV-E of this chapter.

The hierarchy rules for electron cross sections require that each material must use the same electron library. If a specific ZAID is selected, such as ZZZ000.01E, that choice will override any defaults. Alternatively, a default electron library for a given material can be chosen by specifying ELIB = nnE on the M card. However, one can not specify different libraries, nn=01 and nn=03, by any means; overriding this with a fatal option will result in unreliable results. In the absence of either of these specifications, MCNP will use the first electron data table listed in the XSDIR cross section directory file for the relevant element.

### ***D. Neutron Dosimetry Cross Sections***

Dosimetry cross-section tables cannot be used for transport through material. These incomplete cross-section sets provide energy-dependent neutron cross sections to MCNP for use as response

## CHAPTER 2 CROSS SECTIONS

functions with the FM tally feature. ZAIDs of dosimetry tables are of the form ZZZAAA.nnY. Remember, dosimetry cross-section tables have no effect on the particle transport of a problem.

The available dosimetry cross sections are from three sources: ENDF/B–V Dosimetry Tape 531, ENDF/B–V Activation Tape 532, and ACTL<sup>36</sup>—an evaluated neutron activation cross-section library from the Lawrence Livermore National Laboratory. Various codes have been used to process evaluated dosimetry data into the format of MCNP dosimetry tables.

Data on dosimetry tables are simply energy-cross-section pairs for one or more reactions. The energy grids for all reactions are independent of each other. Interpolation between adjacent energy points can be specified as histogram, linear-linear, linear-log, log-linear, or log-log. With the exception of the tolerance involved in any reconstruction of pointwise cross sections from resonance parameters, evaluated dosimetry cross sections can be reproduced on the MCNP data tables with no approximation.

ZAIDs for dosimetry tables must be entered on material cards that are referenced by FM cards, not on Mm cards referenced by cell cards. The complete ZAID, ZZZAAA.nnY, must be given; there are no defaults for dosimetry tables.

### *E. Neutron Thermal $S(\alpha,\beta)$ Tables*

Thermal  $S(\alpha,\beta)$  tables are not required, but they are absolutely essential to get correct answers in problems involving neutron thermalization. Thermal tables have ZAIDs of the form XXXXXX.nnT, where XXXXXX is a mnemonic character string. The data on these tables encompass those required for a complete representation of thermal neutron scattering by molecules and crystalline solids. The source of  $S(\alpha,\beta)$  data is a special set of ENDF tapes.<sup>37</sup> The THERMR and ACER modules of the NJOY<sup>29</sup> system have been used to process the evaluated thermal data into a format appropriate for MCNP.

Data are for neutron energies generally less than 4 eV. Cross sections are tabulated on table-dependent energy grids; inelastic scattering cross sections are always given and elastic scattering cross sections are sometimes given. Correlated energy-angle distributions are provided for inelastically scattered neutrons. A set of equally probable final energies is tabulated for each of several initial energies. Further, a set of equally probable cosines or cosine bins is tabulated for each combination of initial and final energies. Elastic scattering data can be derived from either an incoherent or a coherent approximation. In the incoherent case, equally probable cosines or cosine bins are tabulated for each of several incident neutron energies. In the coherent case, scattering cosines are determined from a set of Bragg energies derived from the lattice parameters. During processing, approximations to the evaluated data are made when constructing equally probable energy and cosine distributions.

ZAIDs for the thermal tables are entered on an MTn card that is associated with an existing Mn card. The thermal table generally will provide data for one component of a material—for example, hydrogen in light water. Thermal ZAIDs may be entered on the MTn card(s) as XXXXXX, XXXXXX.nn, or XXXXXX.nnT.

### ***F. Multigroup Tables***

Multigroup cross section libraries are the only libraries allowed in multigroup/adjoint problems. Neutron multigroup problems cannot be supplemented with  $S(\alpha,\beta)$  thermal libraries; the thermal effects must be included in the multigroup neutron library. Photon problems cannot be supplemented with electron libraries; the electrons must be part of the multigroup photon library. The form of the ZAID is ZZZAAA.nnM or ZZZAAA.nnG for photons only.

Although continuous-energy data are more accurate than multigroup data, the multigroup option is useful for a number of important applications: (1) comparison of deterministic ( $S_n$ ) transport codes to Monte Carlo; (2) use of adjoint calculations in problems where the adjoint method is more efficient; (3) generation of adjoint importance functions; (4) cross section sensitivity studies; (5) solution of problems for which continuous-cross sections are unavailable; and (6) charged particle transport using the Boltzmann-Fokker-Planck algorithm in which charged particles masquerade as neutrons.

Multigroup cross sections are very problem dependent. Some multigroup libraries are available from the Transport Methods Group at Los Alamos but must be used with caution. Users are encouraged to generate or get their own multigroup libraries and then use the supplementary code CRSRD<sup>38</sup> to convert them to MCNP format. Reference 38 describes the conversion procedure. This report also describes how to use both the multigroup and adjoint methods in MCNP and presents several benchmark calculations demonstrating the validity and effectiveness of the multigroup/adjoint method.

To generate cross-section tables for electron/photon transport problems that will use the multigroup Boltzmann-Fokker-Planck algorithm,<sup>39</sup> the CEPXS<sup>40</sup> code developed by Sandia National Laboratory and available from RSICC can be used. The CEPXS manuals describe the algorithms and physics database upon which the code is based; the physics package is essentially the same as ITS version 2.1. The keyword “MONTE-CARLO” is needed in the CEPXS input file to generate a cross-section library suitable for input into CRSRD; this undocumented feature of the CEPXS code should be approached with caution.

## ***IV. PHYSICS***

The physics of neutron, photon, and electron interactions is the very essence of MCNP. This section may be considered a software requirements document in that it describes the equations



## CHAPTER 2 PHYSICS

MCNP is intended to solve. All the sampling schemes essential to the random walk are presented or referenced. But first, particle weight and particle tracks, two concepts that are important for setting up the input and for understanding the output, are discussed in the following sections.

### A. *Particle Weight*

If MCNP were used only to simulate exactly physical transport, then each MCNP particle would represent one physical particle and would have unit weight. However, for computational efficiency, MCNP allows many techniques that do not exactly simulate physical transport. For instance, each MCNP particle might represent a number  $w$  of particles emitted from a source. This number  $w$  is the initial weight of the MCNP particle. The  $w$  physical particles all would have different random walks, but the one MCNP particle representing these  $w$  physical particles will only have one random walk. Clearly this is not an exact simulation; however, the true number of physical particles is preserved in MCNP in the sense of statistical averages and therefore in the limit of large particle numbers (of course including particle production or loss if they occur). Each MCNP particle result is multiplied by the weight so that the full results of the  $w$  physical particles represented by each MCNP particle are exhibited in the final results (tallies). This procedure allows users to normalize their calculations to whatever source strength they desire. The default normalization is to weight one per MCNP particle. A second normalization to the number of Monte Carlo histories is made in the results so that the expected means will be independent of the number of source particles actually initiated in the MCNP calculation.

The utility of particle weight, however, goes far beyond simply normalizing the source. Every Monte Carlo biasing technique alters the probabilities of random walks executed by the particles. The purpose of such biasing techniques is to increase the number of particles that sample some part of the problem of special interest (1) without increasing (sometimes actually decreasing) the sampling of less interesting parts of the problem, and (2) without erroneously affecting the expected mean physical result (tally). This procedure, properly applied, increases precision in the desired result compared to an unbiased calculation taking the same computing time. For example, if an event is made  $\sqrt{2}$  times as likely to occur (as it would occur without biasing), the tally ought to be multiplied by  $1/\sqrt{2}$  so that the expected average tally is unaffected. This tally multiplication can be accomplished by multiplying the particle weight by  $1/\sqrt{2}$  because the tally contribution by a particle is always multiplied by the particle weight in MCNP. Note that weights need not be integers.

In short, particle weight is a number carried along with each MCNP particle, representing that particle's relative contribution to the final tallies. Its magnitude is determined to ensure that whenever MCNP deviates from an exact simulation of the physics, the expected physical result nonetheless is preserved in the sense of statistical averages, and therefore in the limit of large MCNP particle numbers. Its utility is in the manipulation of the number of particles, sampling just a part of the problem to improve the precision of selected results obviating a full unbiased calculation—with its added cost in computing time—to achieve the same results and precision.

**B. Particle Tracks**

When a particle starts out from a source, a particle track is created. If that track is split 2 for 1 at a splitting surface, a second track is created and there are now two tracks from the original source particle, each with half the single track weight. If one of the tracks has an (n,2n) reaction, one more track is started for a total of three. A track refers to each component of a source particle during its history. Track length tallies use the length of a track in a given cell to determine a quantity of interest, such as fluence, flux, or energy deposition. Tracks crossing surfaces are used to calculate fluence, flux, or pulse-height energy deposition (surface estimators). Tracks undergoing collisions are used to calculate multiplication and criticality (collision estimators).

Within a given cell of fixed composition, the method of sampling a collision along the track is determined using the following theory. The probability of a first collision for a particle between  $l$  and  $l + dl$  along its line of flight is given by

$$p(l)dl = e^{-\Sigma_t l} \Sigma_t dl \quad ,$$

where  $\Sigma_t$  is the macroscopic total cross section of the medium and is interpreted as the probability per unit length of a collision. Setting  $\xi$  the random number on  $[0,1)$ , to be

$$\xi = \int_0^l e^{-\Sigma_t s} \Sigma_t ds = 1 - e^{-\Sigma_t l} \quad ,$$

it follows that

$$l = -\frac{1}{\Sigma_t} \ln(1 - \xi) \quad .$$

But, because  $1 - \xi$  is distributed in the same manner as  $\xi$  and hence may be replaced by  $\xi$ , we obtain the well-known expression for the distance to collision,

$$l = \frac{1}{\Sigma_t} \ln(\xi) \quad .$$

**C. Neutron Interactions**

When a particle (representing any number of neutrons, depending upon the particle weight) collides with a nucleus, the following sequence occurs:

1. the collision nuclide is identified;

## CHAPTER 2 PHYSICS

2. either the S(a,b) treatment is used or the velocity of the target nucleus is sampled for low-energy neutrons;
3. photons are optionally generated for later transport;
4. neutron capture (that is, neutron disappearance by any process) is modeled;
5. unless the S(a,b) treatment is used, either elastic scattering or an inelastic reaction is selected, and the new energy and direction of the outgoing track(s) are determined;
6. if the energy of the neutron is low enough and an appropriate S(a,b) table is present, the collision is modeled by the S(a,b) treatment instead of by step 5.

### 1. Section of Collision Nuclide

If there are  $n$  different nuclides forming the material in which the collision occurred, and if  $\xi$  is a random number on the unit interval  $[0,1)$ , then the  $k^{th}$  nuclide is chosen as the collision nuclide if

$$\sum_{i=1}^{k-1} \Sigma_{ti} < \xi \sum_{i=1}^n \Sigma_{ti} \leq \sum_{i=1}^k \Sigma_{ti}$$

where  $\Sigma_{ti}$  is the macroscopic total cross section of nuclide  $i$ . If the energy of the neutron is low enough (below about 4 eV) and the appropriate  $s(\alpha,\beta)$  table is present, the total cross section is the sum of the capture cross section from the regular cross-section table and the elastic and inelastic scattering cross sections from the  $s(\alpha,\beta)$  table. Otherwise, the total cross section is taken from the regular cross-section table and is adjusted for thermal effects as described below.

### 2. Free Gas Thermal Treatment

A collision between a neutron and an atom is affected by the thermal motion of the atom, and in most cases, the collision is also affected by the presence of other atoms nearby. The thermal motion cannot be ignored in many applications of MCNP without serious error. The effects of nearby atoms are also important in some applications. MCNP uses a thermal treatment based on the free gas approximation to account for the thermal motion. It also has an explicit S(a,b) capability that takes into account the effects of chemical binding and crystal structure for incident neutron energies below about 4 eV, but is available for only a limited number of substances and temperatures. The S(a,b) capability is described later on page 2-53.

The free gas thermal treatment in MCNP assumes that the medium is a free gas and also that, in the range of atomic weight and neutron energy where thermal effects are significant, the elastic scattering cross section at zero temperature is nearly independent of the energy of the neutron, and that the reaction cross sections are nearly independent of temperature. These assumptions allow MCNP to have a thermal treatment of neutron collisions that runs almost as fast as a completely nonthermal treatment and that is adequate for most practical problems.

With the above assumptions, the free gas thermal treatment consists of adjusting the elastic cross section and taking into account the velocity of the target nucleus when the kinematics of a collision are being calculated. Note that Doppler broadening of the inelastic cross sections is assumed to have already been done in the processing of the cross section libraries. The free gas thermal treatment effectively applies to elastic scattering only.

a. Adjusting the Elastic Cross Section: The first aspect of the free gas thermal treatment is to adjust the zero-temperature elastic cross section by raising it by the factor

$$F = (1 + 0.5/a^2) \operatorname{erf}(a) + \exp(-a^2)/(a\sqrt{\pi}) \quad ,$$

where  $a = \sqrt{AE/kT}$ ,  $A$  = atomic weight,  $E$  = neutron energy, and  $T$  = temperature. For speed,  $F$  is approximated by  $F = 1 + 0.5/a^2$  when  $a \geq 2$  and by linear interpolation in a table of 51 values of  $aF$  when  $a < 2$ . Both approximations have relative errors less than 0.0001. The total cross section also is increased by the amount of the increase in the elastic cross section.

The adjustment to the elastic and total cross sections is done partly in the setup of a problem and partly during the actual transport calculation. No adjustment is made if the elastic cross section in the data library was already processed to the temperature that is needed in the problem. If all of the cells that contain a particular nuclide have the same temperature, constant in time, that is different from the temperature of the library, the elastic and total cross sections for that nuclide are adjusted to that temperature during the setup so that the transport will run a little faster. Otherwise, these cross sections are reduced, if necessary, to zero temperature during the setup and the thermal adjustment is made when the cross sections are used. For speed, the thermal adjustment is omitted if the neutron energy is greater than  $500 kT/A$ . At that energy the adjustment of the elastic cross section would be less than 0.1%.

b. Sampling the Velocity of the Target Nucleus: The second aspect of the free gas thermal treatment consists of taking into account the velocity of the target nucleus when the kinematics of a collision are being calculated. The target velocity is sampled and subtracted from the velocity of the neutron to get the relative velocity. The collision is sampled in the target-at-rest frame and the outgoing velocities are transformed to the laboratory frame by adding the target velocity.

There are different schools of thought as to whether the relative energy between the neutron and target,  $E_r$ , or the laboratory frame incident neutron energy (target-at-rest),  $E_o$ , should be used for all the kinematics of the collision.  $E_o$  is used in MCNP to obtain the distance-to-collision, select the collision nuclide, determine energy cutoffs, generate photons, generate fission sites for the next generation of a KCODE criticality problem, for  $S(\alpha, \beta)$  scattering, and for capture.  $E_r$  is used for everything else in the collision process, namely elastic and inelastic scattering, including fission and (n,xn) reactions. It is shown in Eqn. 2.1 that  $E_r$  is based upon  $v_{rel}$  that is based upon the elastic scattering cross section, and, therefore,  $E_r$  is truly valid only for elastic

## CHAPTER 2 PHYSICS

scatter. However, the only significant thermal reactions for stable isotopes are absorption, elastic scattering, and fission.  $^{181}\text{Ta}$  has a 6 keV threshold inelastic reaction; all other stable isotopes have higher inelastic thresholds. Metastable nuclides like  $^{242\text{m}}\text{Am}$  have inelastic reactions all the way down to zero, but these inelastic reaction cross sections are neither constant nor  $1/v$  cross sections and these nuclides are generally too massive to be affected by the thermal treatment anyway. Furthermore, fission is very insensitive to incident neutron energy at low energies. The fission secondary energy and angle distributions are nearly flat or constant for incident energies below about 500 keV. Therefore, it makes no significant difference if  $E_r$  is used only for elastic scatter or for other inelastic collisions as well. At thermal energies, whether  $E_r$  or  $E_o$  is used only makes a difference for elastic scattering.

If the energy of the neutron is greater than  $400 kT$  and the target is not  $^1\text{H}$ , the velocity of the target is set to zero. Otherwise, the target velocity is sampled as follows. The free-gas kernel is a thermal interaction model that results in a good approximation to the thermal flux spectrum in a variety of applications and can be sampled without tables. The effective scattering cross section in the laboratory system for a neutron of kinetic energy  $E$  is

$$\sigma_s^{eff}(E) = \frac{1}{v_n} \iint \sigma_s(v_{rel}) v_{rel} p(V) dv \frac{d\mu_t}{2} \quad (2.1)$$

Here,  $v_{rel}$  is the relative velocity between a neutron moving with a scalar velocity  $v_n$  and a target nucleus moving with a scalar velocity  $V$ , and  $\mu_t$  is the cosine of the angle between the neutron and the target direction-of-flight vectors. The equation for  $v_{rel}$  is

$$v_{rel} = (v_n^2 + V^2 - 2v_n V \mu_t)^{\frac{1}{2}}$$

The scattering cross section at the relative velocity is denoted by  $\sigma_s(v_{rel})$ , and  $p(V)$  is the probability density function for the Maxwellian distribution of target velocities,

$$p(V) = \frac{4}{\pi^{1/2}} \beta^3 V^2 e^{-\beta^2 V^2}$$

with  $\beta$  defined as

$$\beta = \left( \frac{AM_n}{2kT} \right)^{\frac{1}{2}},$$

where  $A$  is the mass of a target nucleus in units of the neutron mass,  $M_n$  is the neutron mass in  $\text{MeV}\cdot\text{sh}^2/\text{cm}^2$ , and  $kT$  is the equilibrium temperature of the target nuclei in  $\text{MeV}$ .

The most probable scalar velocity  $V$  of the target nuclei is  $1/\beta$ , which corresponds to a kinetic energy of  $kT$  for the target nuclei. This is not the average kinetic energy of the nuclei, which is  $3kT/2$ . The quantity that MCNP expects on the TMPn input card is  $kT$  and not just  $T$  (see page 3–121). Note that  $kT$  is not a function of the particle mass and is therefore the kinetic energy at the most probable velocity for particles of any mass.

Equation (2.1) implies that the probability distribution for a target velocity  $\mathbf{n}$  and cosine  $\mu_t$  is

$$P(V, \mu_t) = \frac{\sigma_s(v_{rel})v_{rel}P(V)}{2\sigma_s^{eff}(E)v_n} .$$

It is assumed that the variation of  $\sigma_s(v)$  with target velocity can be ignored. The justification for this approximation is that (1) for light nuclei,  $\sigma_s(v_{rel})$  is slowly varying with velocity, and (2) for heavy nuclei, where  $\sigma_s(v_{rel})$  can vary rapidly, the moderating effect of scattering is small so that the consequences of the approximation will be negligible. As a result of the approximation, the probability distribution actually used is

$$P(V, \mu_t) \propto \sqrt{v_n^2 V^2 - 2Vv_n\mu_t} V^2 e^{-\beta^2 V^2} .$$

Note that the above expression can be written as

$$P(V, \mu_t) \propto \frac{\sqrt{v_n^2 + V^2 - 2Vv_n\mu_t}}{v_n + V} (V^3 e^{-\beta^2 V^2} + v_n V^2 e^{-\beta^2 V^2}) .$$

As a consequence, the following algorithm is used to sample the target velocity.

1. With probability  $\alpha = 1/(1 + (\sqrt{\pi}\beta v_n/2))$ , the target velocity  $V$  is sampled from the distribution  $P_1(V) = 2\beta^4 V^3 e^{-\beta^2 V^2}$ . The transformation  $V = \sqrt{y}/\beta$  reduces this distribution to the sampling distribution for  $P(y) = ye^{-y}$ . MCNP actually codes  $1 - \alpha$ .
2. With probability  $1 - \alpha$ , the target velocity is sampled from the distribution  $P_2(V) = (4\beta^3/\sqrt{\pi})V^2 e^{-\beta^2 V^2}$ . Substituting  $V = y/\beta$  reduces the distribution to the sampling distribution for  $y$ :  $P(y) = (4/\sqrt{\pi})y^2 e^{-y^2}$ .
3. The cosine of the angle between the neutron velocity and the target velocity is sampled uniformly on the interval  $-1 \leq \mu_t \leq +1$ .

## CHAPTER 2 PHYSICS

4. The rejection function  $R(V, \mu_t)$  is computed using

$$R(V, \mu_t) = \frac{\sqrt{v_n^2 + V^2 - 2Vv_n\mu_t}}{v_n + V} \leq 1 \quad .$$

With probability  $R(V, \mu_t)$ , the sampling is accepted; otherwise, the sampling is rejected and the procedure is repeated. The minimum efficiency of this rejection algorithm averaged over  $\mu_t$  is 68% and approaches 100% as either the incident neutron energy approaches zero or becomes much larger than  $kT$ .

### 3. Optional Generation of Photons

Photons are generated if the problem is a combined neutron/photon run and if the collision nuclide has a nonzero photon production cross section. The number of photons produced is a function of neutron weight, neutron source weight, photon weight limits (entries on the PWT card), photon production cross section, neutron total cross section, cell importance, and the importance of the neutron source cell. No more than 10 photons may be born from any neutron collision. In a KCODE calculation, secondary photon production from neutrons is turned off during the inactive cycles.

Because of the many low-weight photons typically created by neutron collisions, Russian roulette is played for particles with weight below the bounds specified on the PWT card, resulting in fewer particles, each having a larger weight. The created photon weight before Russian roulette is

$$W_p = \frac{W_n \sigma_\gamma}{\sigma_T} \quad ,$$

where  $W_p$  = photon weight

$W_n$  = neutron weight

$\sigma_\gamma$  = photon production cross section

$\sigma_T$  = total neutron cross section.

Both  $\sigma_\gamma$  and  $\sigma_T$  are evaluated at the incoming neutron energy without the effects of the thermal free gas treatment because nonelastic cross sections are assumed independent of temperature.

The Russian roulette game is played according to neutron cell importances for the collision and source cell. For a photon produced in cell  $i$  where the minimum weight set on the PWT card is

$W_i^{min}$ , let  $I_i$  be the neutron importance in cell  $i$  and let  $I_s$  be the neutron importance in the source cell. If  $W_p > W_i^{min} * I_s / I_i$ , one or more photons will be produced. The number of photons created is  $N_p$ , where  $N_p = (W_p * I_i) / (5 * W_i^{min} * I_s) + 1$ .  $N_p \leq 10$ . Each photon is stored in the bank with weight  $W_p / N_p$ . If  $W_p < W_i^{min} * I_s / I_i$ , Russian roulette is played and the photon survives with probability  $W_p * I_i / (W_i^{min} * I_s)$  and is given the weight,  $W_i^{min} * I_s / I_i$ .

If weight windows are not used and if the weight of the starting neutrons is not unity, setting all the  $W_i^{min}$  on the PWT card to negative values will make the photon minimum weight relative to the neutron source weight. This will make the number of photons being created roughly proportional to the biased collision rate of neutrons. It is recommended for most applications that negative numbers be used and be chosen to produce from one to four photons per source neutron. The default values for  $W_i^{min}$  on the PWT card are  $-1$ , which should be adequate for most problems using cell importances.

If energy-independent weight windows are used, the entries on the PWT card should be the same as on the WWN1:P card. If energy-dependent photon weight windows are used, the entries on the PWT card should be the minimum WWNn:P entry for each cell, where n refers to the photon weight window energy group. This will cause most photons to be born within the weight window bounds.

Any photons generated at neutron collision sites are temporarily stored in the bank. There are two methods for determining the exiting energies and directions, depending on the form in which the processed photon production data are stored in a library. The first method has the evaluated photon production data processed into an “expanded format.”<sup>41</sup> In this format, energy-dependent cross sections, energy distributions, and angular distributions are explicitly provided for every photon-producing neutron interaction. In the second method, used with data processed from older evaluations, the evaluated photon production data have been collapsed so that the only information about secondary photons is in a matrix of 20 equally probable photon energies for each of 30 incident neutron energy groups. The sampling techniques used in each method are now described.

a. Expanded Photon Production Method: In the expanded photon production method, the reaction  $n$  responsible for producing the photon is sampled from

$$\sum_{i=1}^{n-1} \sigma_i < \xi \sum_{i=1}^N \sigma_i \leq \sum_{i=1}^n \sigma_i$$

where  $\xi$  is a random number on the interval (0,1),  $N$  is the number of photon production reactions, and  $\sigma_i$  is the photon production cross section for reaction  $i$  at the incident neutron energy. Note that there is no correlation between the sampling of the type of photon production reaction and the sampling of the type of neutron reaction described on page 2-36.



## CHAPTER 2 PHYSICS

Just as every neutron reaction (for example,  $(n,2n)$ ) has associated energy-dependent angular and energy distributions for the secondary neutrons, every photon production reaction (for example,  $(n,p\gamma)$ ) has associated energy-dependent angular and energy distributions for the secondary photons. The photon distributions are sampled in much the same manner as their counterpart neutron distributions.

All nonisotropic secondary photon angular distributions are represented by 32 equiprobable cosine bins. The distributions are given at a number of incident neutron energies. All photon-scattering cosines are sampled in the laboratory system. The sampling procedure is identical to that described for secondary neutrons on page 2-37.

Secondary photon energy distributions are also a function of incident neutron energy. There are two representations of secondary photon energy distributions allowed in ENDF/B format: tabulated spectra and discrete (line) photons. Correspondingly, there are three laws used in MCNP for the determination of secondary photon energies. Law 4 is an exact representation of tabulated photon spectra. Law 2 is used for discrete photons. Law 44 is for discrete photon lines with a continuous background. These laws are described beginning on page 2-41.

The expanded photon production method has clear advantages over the original 30 x 20 matrix method described below. In coupled neutron/photon problems, users should attempt to specify data sets that contain photon production data in expanded format. Such data sets are identified by “YES P(E)” entries in the GPD column in Table G.2 in Appendix G.

**b. 30 x 20 Photon Production Method:** For lack of better terminology, we will refer to the photon production data contained on older libraries as “30 x 20 photon production” data. In contrast to expanded photon production data, there is no information about individual photon production reactions in the 30 x 20 data.

The only secondary photon data are a 30 x 20 matrix of photon energies; that is, for each of 30 incident neutron energy groups there are 20 equally probable exiting photon energies. There is no information regarding secondary photon angular distributions; therefore, all photons are taken to be produced isotropically in the laboratory system.

There are several problems associated with 30 x 20 photon production data. The 30 x 20 matrix is an inadequate representation of the actual spectrum of photons produced. In particular, discrete photon lines are not well represented, and the high-energy tail of a photon continuum energy distribution is not well sampled. Also, the multigroup representation is not consistent with the continuous-energy nature of MCNP. Finally, not all photons should be produced isotropically. None of these problems exists for data processed into the expanded photon production format.

#### 4. Capture

Capture is treated in one of two ways: analog or implicit. Either way, the incident incoming neutron energy does not include the relative velocity of the target nucleus from the free gas thermal treatment because nonelastic reaction cross sections are assumed to be nearly independent of temperature. That is, only the scattering cross section is affected by the free gas thermal treatment. In MCNP, “absorption” and “capture” are used interchangeably, both meaning  $(n,0n)$ , and  $\sigma_c$  and  $\sigma_a$  are used interchangeably also.

a. Analog Capture: In analog capture, the particle is killed with probability  $\sigma_a/\sigma_T$ , where  $\sigma_a$  and  $\sigma_T$  are the absorption and total cross sections of the collision nuclide at the incoming neutron energy. The absorption cross section is specially defined for MCNP as the sum of all  $(n,x)$  cross sections, where  $x$  is anything except neutrons. Thus  $\sigma_a$  is the sum of  $\sigma_{n,g}$ ,  $\sigma_{n,a}$ ,  $\sigma_{n,d}$ , ... etc. For all particles killed by analog capture, the entire particle energy and weight are deposited in the collision cell.

b. Implicit Capture: For implicit capture, the neutron weight  $W_n$  is reduced to  $W_n$  as follows:

$$W_n \doteq \left(1 - \frac{\sigma_a}{\sigma_T}\right) * W_n$$

If the new weight  $W_n$  is below the problem weight cutoff (specified on the CUT card), Russian roulette is played, resulting overall in fewer particles with larger weight.

For implicit capture, a fraction  $\sigma_a/\sigma_T$  of the incident particle weight and energy is deposited in the collision cell corresponding to that portion of the particle that was captured. Implicit capture is the default method of neutron capture in MCNP.

c. Implicit Capture Along a Flight Path: Implicit capture also can be done continuously along the flight path of a particle trajectory as is the common practice in astrophysics. In this case, the distance to scatter, rather than the distance to collision, is sampled. The distance to scatter is

$$l = -\frac{1}{\Sigma_s} \ln(1 - \xi) \ .$$

The particle weight at the scattering point is reduced by the capture loss,

$$W' = W e^{-\Sigma_a l} \ ,$$

## CHAPTER 2 PHYSICS

where  $W'$  = reduced weight after capture loss,  
 $W$  = weight before capture along flight path,  
 $\sigma_a$  = absorption cross section,  
 $\sigma_s$  = scattering cross section,  
 $\sigma_t$  =  $\sigma_s + \sigma_a$  = total cross section,  
 $l$  = distance to scatter, and  
 $\xi$  = random number.

Implicit capture along a flight path is a special form of the exponential transformation coupled with implicit capture at collisions. (See the description of the exponential transform on page 2-141.) The path length is stretched in the direction of the particle,  $\mu = 1$ , and the stretching parameter is  $p = \Sigma_a/\Sigma_t$ . Using these values the exponential transform and implicit capture at collisions yield the identical equations as does implicit capture along a flight path.

Implicit capture along a flight path is invoked in MCNP as a special option of the exponential transform variance reduction method. It is most useful in highly absorbing media, that is,  $\Sigma_a/\Sigma_t$  approaches 1. When almost every collision results in capture, it is very inefficient to sample distance to collision. However, implicit capture along a flight path is discouraged. In highly absorbing media, there is usually a superior set of exponential transform parameters. In relatively nonabsorbing media, it is better to sample the distance to collision than the distance to scatter.

### 5. Elastic and Inelastic Scattering

If the conditions for the  $S(\alpha, \beta)$  treatment are not met, the particle undergoes either an elastic or inelastic collision. The selection of an elastic collision is made with probability

$$\frac{\sigma_{el}}{\sigma_{in} + \sigma_{el}} = \frac{\sigma_{el}}{\sigma_T - \sigma_a}$$

where

$\sigma_{el}$  is the elastic scattering cross section.

$\sigma_{in}$  is the inelastic cross section; includes any neutron-out process— $(n, n')$ ,  $(n, f)$ ,  $(n, np)$ , etc.

$\sigma_a$  is the absorption cross section;  $\Sigma\sigma(n, x)$ ,  $\neq n$ , that is, all neutron disappearing reactions.

$\sigma_T$  is the total cross section,  $\sigma_T = \sigma_{el} + \sigma_{in} + \sigma_a$ .

Both  $\sigma_{el}$  and  $\sigma_T$  are adjusted for the free gas thermal treatment at thermal energies.

The selection of an inelastic collision is made with the remaining probability

$$\frac{\sigma_{in}}{\sigma_T - \sigma_a} .$$

If the collision is determined to be inelastic, the type of inelastic reaction,  $n$ , is sampled from

$$\sum_{i=1}^{n-1} \sigma_i < \xi \sum_{i=1}^N \sigma_i \leq \sum_{i=1}^n \sigma_i ,$$

where  $\xi$  is a random number on the interval  $[0,1)$ ,  $N$  is the number of inelastic reactions, and the  $\sigma_i$ 's are the inelastic reaction cross sections at the incident neutron energy.

For both elastic and inelastic scattering, the direction of exiting particles usually is determined by sampling angular distribution tables from the cross-section files. This process is described shortly. For elastic collisions and discrete inelastic scattering from levels, the exiting particle energy is determined from two body kinematics based upon the center-of-mass cosine of the scattering angle. For other inelastic processes, the energy of exiting particles is determined from secondary energy distribution laws from the cross-section files, which vary according to the particular inelastic collision modeled.

**a. Sampling of Angular Distributions:** The direction of emitted particles is sampled in the same way for most elastic and inelastic collisions. The cosine of the angle between incident and exiting particle directions,  $\mu$ , is sampled from angular distribution tables in the collision nuclide's cross-section library. The angular distribution tables consist of 32 equiprobable cosine bins and are given at a number of different incident neutron energies. The cosines are either in the center-of-mass or target-at-rest system, depending on the type of reaction. If  $E$  is the incident neutron energy, if  $E_n$  is the energy of table  $n$ , and if  $E_{n+1}$  is the energy of table  $n + 1$ , then a value of  $\mu$  is sampled from table  $n + 1$  with probability  $(E - E_n)/(E_{n+1} - E_n)$  and from table  $n$  with probability  $(E_{n+1} - E)/(E_{n+1} - E_n)$ . A random number  $\xi$  on the interval  $[0,1)$  is then used to select the  $i^{th}$  cosine bin such that  $i = 32 \xi + 1$ . The value of  $\mu$  is then computed as

$$\mu = \mu_i + (32 \xi - i)(\mu_{i+1} - \mu_i) .$$

If, for some incident neutron energy, the emitted angular distribution is isotropic,  $\mu$  is chosen from  $\mu = \xi'$ , where  $\xi'$  is a random number on the interval  $[-1,1)$ . (Strictly, in MCNP random numbers are always furnished on the interval  $[0,1)$ . Thus, to compute  $\xi'$  on  $[-1,1)$  we calculate  $\xi' = 2 \xi - 1$ , where  $\xi$  is a random number on  $[0,1)$ .)

For elastic scattering, inelastic level scattering, and some ENDF/B-VI inelastic reactions, the scattering cosine is chosen in the center-of-mass system. Conversion must then be made to  $\mu_{lab}$ , the cosine in the target-at-rest system. For other inelastic reactions, the scattering cosine is sampled directly in the target-at-rest system.

## CHAPTER 2 PHYSICS

The incident particle direction cosines,  $(u_o, v_o, w_o)$ , are rotated to new outgoing target-at-rest system cosines,  $(u, v, w)$ , through a polar angle whose cosine is  $\mu_{lab}$ , and through an azimuthal angle sampled uniformly. For random numbers  $\xi_1$  and  $\xi_2$  on the interval  $[-1,1)$  with rejection criterion  $\xi_1^2 \xi_2^2 \leq 1$ , the rotation scheme is (Ref. 2, pg. 54):

$$u = u_o \mu_{lab} + \frac{\sqrt{1 - \mu_{lab}^2} (\xi_1 u_o w_o - \xi_2 v_o)}{\sqrt{(\xi_1^2 + \xi_2^2)(1 - w_o^2)}}$$

$$v = v_o \mu_{lab} + \frac{\sqrt{1 - \mu_{lab}^2} (\xi_1 v_o w_o + \xi_2 u_o)}{\sqrt{(\xi_1^2 + \xi_2^2)(1 - w_o^2)}}$$

$$w = w_o \mu_{lab} - \frac{\xi_1 \sqrt{(1 - \mu_{lab}^2)(1 - w_o^2)}}{\sqrt{(\xi_1^2 + \xi_2^2)}} .$$

If  $1 - w_o^2 \sim 0$ , then

$$u = u_o \mu_{lab} + \frac{\sqrt{1 - \mu_{lab}^2} (\xi_1 u_o v_o + \xi_2 w_o)}{\sqrt{(\xi_1^2 + \xi_2^2)(1 - v_o^2)}}$$

$$v = v_o \mu_{lab} - \frac{\xi_1 \sqrt{(1 - \mu_{lab}^2)(1 - v_o^2)}}{\sqrt{(\xi_1^2 + \xi_2^2)}}$$

$$w = w_o \mu_{lab} + \frac{\sqrt{1 - \mu_{lab}^2} (\xi_1 w_o v_o - \xi_2 u_o)}{\sqrt{(\xi_1^2 + \xi_2^2)(1 - v_o^2)}} .$$

If the scattering distribution is isotropic in the target-at-rest system, it is possible to use an even simpler formulation that takes advantage of the exiting direction cosines,  $(u, v, w)$ , being independent of the incident direction cosines,  $(u_o, v_o, w_o)$ . In this case,

$$u = 2\xi_1^2 + 2\xi_2^2 - 1$$

$$v = \xi_1 \sqrt{\frac{1 - u^2}{\xi_1^2 + \xi_2^2}}$$

$$w = \xi_2 \sqrt{\frac{1-u^2}{\xi_1^2 + \xi_2^2}},$$

where  $\xi_1$  and  $\xi_2$  are rejected if  $\xi_1^2 + \xi_2^2 > 1$ .

b. Elastic Scattering: The particle direction is sampled from the appropriate angular distribution tables, and the exiting energy,  $E_{out}$ , is dictated by two-body kinematics:

$$\begin{aligned} E_{out} &= \frac{1}{2} E_{in} [(1 - \alpha)\mu_{cm} + 1 + \alpha] \\ &= E_{in} \left[ \frac{1 + A^2 + 2A\mu_{cm}}{(1 + A)^2} \right], \end{aligned}$$

where  $E_{in}$  = incident neutron energy,  $\mu_{cm}$  = center-of-mass cosine of the angle between incident and exiting particle directions,

$$\alpha = \left( \frac{A - 1}{A + 1} \right)^2$$

and  $A$  = mass of collision nuclide in units of the mass of a neutron (atomic weight ratio).

c. Inelastic Scattering: The treatment of inelastic scattering depends upon the particular inelastic reaction chosen. Inelastic reactions are defined as  $(n,y)$  reactions such as  $(n, n')$ ,  $(n, 2n)$ ,  $(n, f)$ ,  $(n, n'\alpha)$  in which  $y$  includes at least one neutron.

For many inelastic reactions, such as  $(n, 2n)$ , more than one neutron can be emitted for each incident neutron. The weight of each exiting particle is always the same as the weight of the incident particle minus any implicit capture. The energy of exiting particles is governed by various scattering laws that are sampled independently from the cross-section files for each exiting particle. Which law is used is prescribed by the particular cross-section evaluation used. In fact, more than one law can be specified, and the particular one used at a particular time is decided with a random number. In an  $(n, 2n)$  reaction, for example, the first particle emitted may have an energy sampled from one or more laws, but the second particle emitted may have an energy sampled from one or more different laws, depending upon specifications in the nuclear data library. Because emerging energy and scattering angle is sampled independently for each particle, there is no correlation between the emerging particles. Hence energy is not conserved in an individual reaction because, for example, a 14-MeV particle could conceivably produce two 12-MeV particles in a single reaction. But the net effect of many particle histories is unbiased because on the average the correct amount of energy is emitted. Results are biased only

## CHAPTER 2 PHYSICS

when quantities that depend upon the correlation between the emerging particles are being estimated.

Users should note that MCNP follows a very particular convention. The exiting particle energy and direction are always given in the target-at-rest (laboratory) coordinate system. For the kinematical calculations in MCNP to be performed correctly, the angular distributions for elastic, discrete inelastic level scattering, and some ENDF/B–VI inelastic reactions *must* be given in the center-of-mass system, and the angular distributions for all other reactions {it must} be given in the target-at-rest system. MCNP does not stop if this convention is not adhered to, but the results will be erroneous. In the checking of the cross-section libraries prepared for MCNP at Los Alamos, however, careful attention has been paid to ensure that these conventions are followed.

The exiting particle energy and direction in the target–at–rest (laboratory) coordinate system are related to the center–of–mass energy and direction as follows:<sup>1</sup>

$$E' = E'_{cm} + \left[ \frac{E + 2\mu_{cm}(A + 1)\sqrt{EE'_{cm}}}{(A + 1)^2} \right] ; \text{ and}$$

$$\mu_{lab} = \mu_{cm} \sqrt{\frac{E'_{cm}}{E'}} + \frac{1}{A + 1} \sqrt{\frac{E}{E'}}$$

where

- $E'$  = exiting particle energy (laboratory),
- $E'_{cm}$  = exiting particle energy (center-of-mass),
- $E$  = incident particle energy (laboratory),
- $\mu_{cm}$  = cosine of center–of–mass scattering angle,
- $\mu_{lab}$  = cosine of laboratory scattering angle,
- $A$  = atomic weight ratio (mass of nucleus divided by mass of incident particle.)

For point detectors it is necessary to convert

$$p(\mu_{lab}) = p(\mu_{cm}) \frac{d\mu_{cm}}{d\mu_{lab}} ,$$

where

$$\mu_{cm} = \mu_{lab} \sqrt{\frac{E'}{E'_{cm}}} - \frac{1}{A+1} \sqrt{\frac{E}{E'_{cm}}} \quad \text{and}^1$$

$$\frac{d\mu_{cm}}{d\mu_{lab}} = \frac{E'/E'_{cm}}{\sqrt{\frac{E'}{E'_{cm}}} - \frac{\mu_{lab}}{A+1} \sqrt{\frac{E}{E'_{cm}}}}$$

$$= \frac{\sqrt{\frac{E'}{E'_{cm}}}}{1 - \frac{\mu_{lab}}{A+1} \sqrt{\frac{E}{E'_{cm}}}}$$

d. Nonfission Inelastic Scattering and Emission Laws: Nonfission inelastic reactions are handled differently from fission inelastic reactions. For each nonfission reaction  $N_p$  particles are emitted, where  $N_p$  is an integer quantity specified for each reaction in the cross-section data library of the collision nuclide. The direction of each emitted particle is independently sampled from the appropriate angular distribution table, as was described earlier. The energy of each emitted particle is independently sampled from one of the following scattering or emission laws. Energy and angle are correlated only for ENDF/B--VI laws 44 and 67. For completeness and convenience we list all the laws together, regardless of whether the law is appropriate for nonfission inelastic scattering (for example, Law~3), fission spectra (for example, Law 11), both (for example, Law 9), or neutron-induced photon production (for example, Law 2). The conversion from center-of-mass to target-at-rest (laboratory) coordinate systems is as above.

Law 1 (ENDF law 1): Equiprobable energy bins.

The index  $i$  and the interpolation fraction  $r$  are found on the incident energy grid for the incident energy  $E_{in}$  such that

$$E_i < E_{in} < E_{i+1} \quad \text{and}$$

$$E_{in} = E_i + r(E_{i+1} - E_i) \quad .$$

A random number on the unit interval  $\xi_1$  is used to select an equiprobable energy bin  $k$  from the  $K$  equiprobable outgoing energies  $E_{ik}$

$$k = \xi_1 K + 1 \quad .$$

Then scaled interpolation is used with random numbers  $\xi_2$  and  $\xi_3$  on the unit interval. Let

$$E_1 = E_{i,1} + r(E_{i+1,1} - E_{i,1}) \quad \text{and}$$



**CHAPTER 2  
PHYSICS**

$$E_K = E_{i,K} + r(E_{i+1,K} - E_{i,K}) ; \text{ and}$$

$$l = i \text{ if } \xi_3 > r \text{ or}$$

$$l = i + 1 \text{ if } \xi_3 < r \text{ and}$$

$$E' = E_{l,k} + \xi_2(E_{l,k+1} - E_{l,k}) ; \text{ then}$$

$$E_{out} = E_1 + \frac{(E' - E_{l,1})(E_K - E_1)}{E_{l,K} - E_{l,1}} .$$

Law 2 Discrete photon energy.

The value provided in the library is  $E_g$ . The secondary photon energy

$E_{out}$  is either

$E_{out} = E_g$  for non-primary photons or

$E_{out} = E_g + [A/(A+1)]E_{in}$  for primary photons,

where  $A$  is the atomic weight to neutron weight ratio of the target and  $E_{in}$  is the incident neutron energy.

Law 3 (ENDF law 3): Inelastic scattering ( $n,n'$ ) from nuclear levels.

The value provided in the library is  $Q$ .

$$E_{out} = \left( \frac{A}{A+1} \right)^2 \left[ E_{in} - \frac{Q(A+1)}{A} \right] .$$

Law 4 Tabular distribution (ENDF law 4).

For each incident neutron energy  $E_i$  there is a pointer to a table of secondary energies  $E_{i,k}$ , probability density functions  $p_{i,k}$ , and cumulative density functions  $c_{i,k}$ . The index  $i$  and the interpolation fraction  $r$  are found on the incident energy grid for the incident energy  $E_{in}$  such that

$$E_i < E_{in} < E_{i+1} \quad \text{and}$$

$$E_{in} = E_i + r(E_{i+1} - E_i) .$$

A random number on the unit interval  $\xi_j$  is used to sample a secondary energy bin  $k$  from the cumulative density function

$$c_{i,k} + r(c_{i+1,k} - c_{i,k}) < \xi_1 < c_{i,k+1} + r(c_{i+1,k+1} - c_{i,k+1})$$

If these are discrete line spectra, then the sampled energy  $E'$  is interpolated between incident energy grids as

$$E' = E_{i,k} + r(E_{i+1,k} - E_{i,k}) \quad .$$

It is possible to have all discrete lines, all continuous spectra, or a mixture of discrete lines superimposed on a continuous background. For continuous distributions, the secondary energy bin  $k$  is sampled from

$$c_{l,k} < \xi_1 < c_{l,k+1} \quad ,$$

where  $l = i$  if  $\xi_2 > r$  and  $l = i + 1$  if  $\xi_2 < r$ , and  $\xi_2$  is a random number on the unit interval. For histogram interpolation the sampled energy is

$$E' = E_{l,k} + \frac{(\xi_1 - c_{l,k})}{p_{l,k}} \quad .$$

For linear-linear interpolation the sampled energy is

$$E' = E_{l,k} + \left\{ \frac{\sqrt{P_{l,k}^2 + 2 \left[ \frac{p_{l,k+1} - p_{l,k}}{E_{l,k+1} - E_{l,k}} \right] (\xi_1 - c_{l,k}) - p_{l,k}}}{\left[ \frac{p_{l,k+1} - p_{l,k}}{E_{l,k+1} - E_{l,k}} \right]} \right\}$$

For neutron-induced photons,  $E_{out} = E'$  and the angle is selected as described on page 2-37. That is, the photon secondary energy is sampled from either of the two bracketing incident energy bins,  $l = i$  or  $l = i + 1$ .

The neutron secondary energy must be interpolated between the incident energy bins  $i$  and  $i + 1$  to properly preserve thresholds. Let

$$E_1 = E_{i,1} + r(E_{i+1,1} - E_{i,1}) \quad \text{and}$$

$$E_K = E_{i,K} + r(E_{i+1,K} - E_{i,K}); \quad \text{then}$$

$$E_{out} = E_1 + \frac{(E' - E_{l,1})(E_K - E_1)}{(E_{l,K} - E_{l,1})} \quad .$$

## CHAPTER 2 PHYSICS

The outgoing neutron energy is then adjusted to the laboratory system, if it is in the center-of-mass system, and the outgoing angle is selected as described on page 2–37.

Law 5 (ENDF law 5): General evaporation spectrum.

The function  $g(x)$  is tabulated versus  $\chi$  and the energy is tabulated versus incident energy  $E_{in}$ . The law is then

$$f(E_{in} \rightarrow E_{out}) = g\left(\frac{E_{out}}{T(E_{in})}\right) .$$

This density function is sampled by

$$E_{out} = \chi(\xi) T(E_{in}),$$

where  $T(E_{in})$  is a tabulated function of the incident energy and  $c(\xi)$  is a table of equiprobable  $\chi$  values.

Law 7 (ENDF law 7): Simple Maxwell Fission Spectrum.

$$f(E_{in} \rightarrow E_{out}) = C * \sqrt{E_{out}} e^{-E_{out}/T(E_{in})}$$

The nuclear temperature  $T(E_{in})$  is a tabulated function of the incident energy. The normalization constant  $C$  is given by

$$C^{-1} = T^{3/2} \left[ \left( \frac{\sqrt{\pi}}{2} \right) \operatorname{erf} \left( \sqrt{\frac{(E_{in} - U)}{T}} \right) - \sqrt{\frac{(E_{in} - U)}{T}} e^{-(E_{in} - U)/T} \right]$$

$U$  is a constant provided in the library and limits  $E_{out}$  to  $0 \leq E_{out} \leq E_{in} - U$ . In MCNP this density function is sampled by the rejection scheme

$$E_{out} = -T(E_{in}) \left[ \frac{\xi_1^2 \ln \xi_3}{\xi_1^2 + \xi_2^2} + \ln \xi_4 \right] ,$$

where  $\xi_1, \xi_2, \xi_3$ , and  $\xi_4$  are random numbers on the unit interval.  $\xi_1$  and  $\xi_2$  are rejected if  $\xi_1^2 + \xi_2^2 > 1$

Law 9 (ENDF law 9): Evaporation spectrum.

$$f(E_{in} \rightarrow E_{out}) = C E_{out} e^{-E_{out}/T(E_{in})} ,$$

where the nuclear temperature  $T(E_{in})$  is a tabulated function of the incident energy. The energy  $U$  is provided in the library and is assigned so that  $E_{out}$  is limited by  $0 \leq E_{out} \leq E_{in} - U$ . The normalization constant  $C$  is given by

$$C^{-1} = T^2 [1 - e^{-(E_{in}-U)/T} (1 + (E_{in} - U)/T)] .$$

In MCNP this density function is sampled by

$$E_{out} = -T(E_{in}) \ln(\xi_1 \xi_2) ,$$

where  $\xi_1$  and  $\xi_2$  are random numbers on the unit interval, and  $\xi_1$  and  $\xi_2$  are rejected if  $E_{out} > E_{in} - U$ .

Law 11 (ENDF law 11): Energy Dependent Watt Spectrum.

$$f(E_{in} \rightarrow E_{out}) = C e^{-E_{out}/a(E_{in})} \sinh \sqrt{b(E_{in}) E_{out}} .$$

The constants  $a$  and  $b$  are tabulated functions of incident energy and  $U$  is a constant from the library. The normalization constant  $C$  is given by

$$c^{-1} = \frac{1}{2} \sqrt{\frac{\pi a^3 b}{4}} \exp\left(\frac{ab}{4}\right) \left[ \operatorname{erf}\left(\sqrt{\frac{(E_{in}-U)}{a}} - \sqrt{\frac{ab}{4}}\right) + \operatorname{erf}\left(\sqrt{\frac{(E_{in}-U)}{a}} + \sqrt{\frac{ab}{4}}\right) \right] \\ - a \exp\left[-\frac{(E_{in}-U)}{a}\right] \sinh \sqrt{b(E_{in}-U)} ,$$

where the constant  $U$  limits the range of outgoing energy so that  $0 \leq E_{out} \leq E_{in} - U$ . This density function is sampled as follows. Let

$$g = \sqrt{\left(1 + \frac{ab}{8}\right)^2 - 1} + \left(1 + \frac{ab}{8}\right). \quad \text{Then } E_{out} = -ag \ln \xi_1.$$

$E_{out}$  is rejected if

$$[(1-g)(1 - \ln \xi_1) - \ln \xi_2]^2 > bE_{out} ,$$

where  $\xi_1$  and  $\xi_2$  are random numbers on the unit interval.

## CHAPTER 2 PHYSICS

Law 22 (UK law 2): Tabular linear functions of incident energy out.

Tables of  $P_{ij}$ ,  $C_{ij}$ , and  $T_{ij}$  are given at a number of incident energies  $E_i$ . If  $E_i \leq E_{in} < E_{i+1}$  then the  $i^{th}$   $P_{ij}$ ,  $C_{ij}$ , and  $T_{ij}$  tables are used.

$$E_{out} = C_{ik}(E_{in} - T_{ik}) ,$$

where  $k$  is chosen according to

$$\sum_{j=1}^k P_{ij} < \xi \leq \sum_{j=1}^{k+1} P_{ij} ,$$

where  $\xi$  is a random number on the unit interval [0,1).

Law 24 (UK law 6): Equiprobable energy multipliers. The law is

$$E_{out} = E_{in}T(E_{in}) .$$

The library provides a table of  $K$  equiprobable energy multipliers  $T_{i,k}$  for a grid of incident neutron energies  $E_i$ . For incident energy  $E_{in}$  such that

$$E_i < E_{in} < E_{i+1} ,$$

the random numbers  $\xi_1$  and  $\xi_2$  on the unit interval are used to find  $T$ :

$$k = \xi_1 K + 1$$

$$T = T_{i,k} + \xi_2(T_{i,k+1} - T_{i,k}) \text{ and then}$$

$$E_{out} = E_{in}T .$$

Law 44 Tabular Distribution (ENDF/B-VI file 6 law=1 lang=2, Kalbach-87 correlated energy-angle scattering). Law 44 is a generalization of law 4. For each incident neutron energy  $E_i$  there is a pointer to a table of secondary energies  $E_{i,k}$ , probability density functions  $p_{i,k}$ , cumulative density functions  $c_{i,k}$ , precompound fractions  $R_{i,k}$ , and angular distribution slope values  $A_{i,k}$ . The index  $i$  and the interpolation fraction  $r$  are found on the incident energy grid for the incident energy  $E_{in}$  such that

$$E_i < E_{in} < E_{i+1} \quad \text{and}$$

$$E_{in} = E_{i+r}(E_{i+1} - E_i) .$$

A random number on the unit interval  $\xi_1$  is used to sample a secondary energy bin  $k$  from the cumulative density function

$$c_{i,k} + r(c_{i+1,k} - c_{i,k}) < \xi_1 < c_{i,k+1} + r(c_{i+1,k+1} - c_{i,k+1}) \quad .$$

If these are discrete line spectra, then the sampled energy  $E'$  is interpolated between incident energy grids as

$$E' = E_{i,k} + r(E_{i+1,k} - E_{i,k}) \quad .$$

It is possible to have all discrete lines, all continuous spectra, or a mixture of discrete lines superimposed on a continuous background. For continuous distributions, the secondary energy bin  $k$  is sampled from

$$c_{l,k} < \xi_1 < c_{l,k+1} \quad ,$$

where  $l = i$  if  $\xi_2 > r$  and  $l = i + 1$  if  $\xi_2 < r$ , and  $\xi_2$  is a random number on the unit interval. For histogram interpolation the sampled energy is

$$E' = E_{l,k} + \frac{(\xi_1 - c_{l,k})}{p_{l,k}} \quad .$$

For linear-linear interpolation the sampled energy is

$$E' = E_{l,k} + \left\{ \frac{\sqrt{p_{l,k}^2 + 2 \left[ \frac{p_{l,k+1} - p_{l,k}}{E_{l,k+1} - E_{l,k}} \right] (\xi_1 - c_{l,k}) - p_{l,k}}}{\left[ \frac{p_{l,k+1} - p_{l,k}}{E_{l,k+1} - E_{l,k}} \right]} \right\} \quad ..$$

Unlike Law 4, the sampled energy is interpolated between the incident energy bins  $i$  and  $i + 1$  for both neutron-induced photons and neutrons. Let

$$E_1 = E_{i,1} + r(E_{i+1,1} - E_{i,1}) \quad \text{and}$$

$$E_K = E_{i,K} + r(E_{i+1,K} - E_{i,K}); \quad \text{then}$$

$$E_{out} = E_1 + \frac{(E' - E_{i,1})(E_K - E_1)}{(E_{i,K} - E_{i,1})} \quad .$$

For neutron-induced photons, the outgoing angle is selected as described on page 2–37. For neutrons,  $E_{out}$  is always in the center-of-mass system and must be adjusted to the laboratory system. The outgoing neutron center-of-mass scattering angle  $\mu$  is sampled from the Kalbach-87 density function

**CHAPTER 2  
PHYSICS**

$$p(\mu, E_{in}, E_{out}) = \frac{1}{2} \frac{A}{\sinh(A)} [\cosh(A\mu) + R \sinh(A\mu)]$$

using the random numbers  $\xi_3$  and  $\xi_4$  on the unit interval as follows. If  $\xi_3 > R$ , then let

$$T = (2\xi_4 - 1) \sinh(A) \quad \text{and}$$

$$\mu = \ln(T + \sqrt{T^2 + 1}) / A \quad ,$$

or if  $\xi_3 < R$ , then

$$\mu = \ln \left[ \xi_4 e^A + (1 - \xi_4) e^{-A} \right] / A \quad .$$

$R$  and  $A$  are interpolated on both the incident and outgoing energy grids. For discrete spectra,

$$A = A_{i,k} + r(A_{i+1,k} - A_{i,k}) \quad ,$$

$$R = R_{i,k} + r(R_{i+1,k} - R_{i,k}) \quad .$$

For continuous spectra with histogram interpolation,

$$A = A_{l,k} \quad ,$$

$$R = R_{l,k} \quad .$$

For continuous spectra with linear-linear interpolation,

$$A = A_{l,k} + (A_{l,k+1} - A_{l,k})(E' - E_{l,k}) / (E_{l,k+1} - E_{l,k}) \quad ,$$

$$R = R_{l,k} + (R_{l,k+1} - R_{l,k})(E' - E_{l,k}) / (E_{l,k+1} - E_{l,k}) \quad .$$

The Kalbach-87 formalism (Law 44) is also characterized by an energy-dependent multiplicity in which the number of neutrons emerging from a collision varies. If the number is less than one, Russian roulette is played and the collision can result in a capture. If the number is greater than one, the usual MCNP approach is taken whereby the additional particles are banked and only the first one contributes to detectors and DXTRAN.

Law 66 N-body phase space distribution (ENDF/B-VI file 6 law 6).

The phase space distribution for particle  $i$  in the center-of-mass coordinate system is:

$$P_i(\mu, E_{in}, T) = C_n \sqrt{T} (E_i^{max} - T)^{3n/2 - 4} ,$$

where all energies and angles are also in the center-of-mass system and  $E_i^{max}$  is the maximum possible energy for particle  $i$ ,  $\mu$  and  $T$ .  $T$  is used for calculating  $E_{out}$ . The  $C_n$  normalization constants for  $n = 3, 4, 5$  are:

$$C_3 = \frac{4}{\pi(E_i^{max})^2} ,$$

$$C_4 = \frac{105}{32(E_i^{max})^{7/2}} , \quad \text{and}$$

$$C_5 = \frac{256}{14\pi(E_i^{max})^5} .$$

$E_i^{max}$  is a fraction of the energy available,  $E_a$ ,

$$E_i^{max} = \frac{M - m_i}{M} E_a ,$$

where  $M$  is the total mass of the  $n$  particles being treated,  $m_i$  is the mass of particle  $i$ , and

$$E_a = \frac{m_T}{m_p + m_T} E_{in} + Q ,$$

where  $m_T$  is the target mass and  $m_p$  is the projectile mass. For neutrons,

$$\frac{m_T}{m_p + m_T} = \frac{A}{A + 1}$$

and for a total mass ratio  $A_p = M/m_i$ ,

$$\frac{M - m_i}{M} = \frac{A_p - 1}{A_p} .$$

Thus,

$$E_i^{max} = \frac{A_p - 1}{A_p} \left( \frac{A}{A + 1} E_{in} + Q \right) .$$



## CHAPTER 2 PHYSICS

The total mass  $A_p$  and the number of particles in the reaction  $n$  are provided in the data library. The outgoing energy is sampled as follows.

Let  $\xi_i$ ,  $i = 1, 9$  be random numbers on the unit interval. Then from rejection technique R28 from the Monte Carlo Sampler,<sup>3</sup> accept  $\xi_1$  and  $\xi_2$  if

$$\xi_1^2 + \xi_2^2 \leq 1$$

and accept  $\xi_3$  and  $\xi_4$  if

$$\xi_3^2 + \xi_4^2 \leq 1 \quad .$$

Then let

$$p = \xi_5 \text{ if } n = 3 \text{ ,}$$

$$p = \xi_5 \xi_6 \text{ if } n = 4 \text{ , and}$$

$$p = \xi_5 \xi_6 \xi_7 \xi_8 \text{ if } n = 5 \text{ ,}$$

and let

$$x = \frac{-\xi_1 \ln(\xi_1^2 + \xi_2^2)}{(\xi_1^2 + \xi_2^2)} - \ln \xi_9 \text{ ,}$$

$$y = \frac{-\xi_3 \ln(\xi_3^2 + \xi_4^2)}{(\xi_3^2 + \xi_4^2)} - \ln p \text{ , and}$$

$$T = \frac{x}{x+y} \text{ ;}$$

then

$$E_{out} = T E_i^{max} \text{ .}$$

The cosine of the scattering angle is always sampled isotropically in the center-of-mass system using another random number  $\xi_2$  on the unit interval:

$$\mu = 2\xi_2 - 1 \text{ .}$$

Law 67 Correlated energy-angle scattering (ENDF/B-VI file 6 law 7).

For each incident neutron energy, first the exiting particle direction  $\mu$  is sampled as described on page 2–37. In other Law data, first the exiting particle energy is sampled and then the angle is sampled. The index  $i$  and the interpolation fraction  $r$  are found on the incident energy grid for the incident energy  $E_{in}$ , such that

$$E_i < E_{in} < E_{i+1} \quad \text{and}$$

$$E_{in} = E_i + r(E_{i+1} - E_i) \quad .$$

For each incident energy  $E_i$  there is a table of exiting particle direction cosines  $\mu_{i,j}$  and locators  $L_{i,j}$ . This table is searched to find which ones bracket  $\mu$ , namely,

$$\mu_{i,j} < \mu < \mu_{i,j+1} \quad .$$

Then the secondary energy tables at  $L_{i,j}$  and  $L_{i,j+1}$  are sampled for the outgoing particle energy.

The secondary energy tables consist of a secondary energy grid  $E_{i,j,k}$ , probability density functions  $p_{i,j,k}$ , and cumulative density functions  $c_{i,j,k}$ . A random number  $\xi_1$  on the unit interval is used to pick between incident energy indices: if  $\xi_1 < r$  then  $l = i + 1$ ; otherwise,  $l = i$ . Two more random numbers  $\xi_2$  and  $\xi_3$  on the unit interval are used to determine interpolation energies.

If  $\xi_2 < (\mu - \mu_{l,j}) / (\mu_{l,j+1} - \mu_{l,j})$ , then

$$E_{i,k} = E_{i,j+1,k} \quad \text{and} \quad m = j + 1, \quad \text{if} \quad l = i \quad .$$

Otherwise,

$$E_{i,k} = E_{i,j,k} \quad \text{and} \quad m = j, \quad \text{if} \quad l = i \quad .$$

If  $\xi_3 < (\mu - \mu_{i+1,j}) / (\mu_{i+1,j+1} - \mu_{i+1,j})$ , then

$$E_{i+1,k} = E_{i+1,j+1,k} \quad \text{and} \quad m = j + 1, \quad \text{if} \quad l = i + 1 \quad .$$

Otherwise,

$$E_{i+1,k} = E_{i+1,j,k} \quad \text{and} \quad m = j, \quad \text{if} \quad l = i + 1 \quad .$$

A random number  $\xi_4$  on the unit interval is used to sample a secondary energy bin  $k$  from the cumulative density function

$$c_{l,m,k} < \xi_4 < c_{l,m,k+1} \quad .$$

For histogram interpolation the sampled energy is

**CHAPTER 2**  
**PHYSICS**

$$E' = E_{l,m,k} + \frac{(\xi_4 - c_{l,m,k})}{P_{l,m,k}} .$$

For linear-linear interpolation the sampled energy is

$$E' = E_{l,m,k} + \left\{ \frac{\sqrt{P_{l,m,k}^2 + 2 \left[ \frac{P_{l,m,k+1} - P_{l,m,k}}{E_{l,m,k+1} - E_{l,m,k}} \right] (\xi_4 - c_{l,m,k}) - P_{l,m,k}}}{\left[ \frac{P_{l,m,k+1} - P_{l,m,k}}{E_{l,m,k+1} - E_{l,m,k}} \right]} \right\} .$$

The final outgoing energy  $E_{out}$  uses scaled interpolation. Let

$$E_1 = E_{i,1} + r(E_{i+1,1} - E_{i,1})$$

$$\text{and } E_K = E_{i,K} + r(E_{i+1,K} - E_{i,K}) .$$

$$\text{Then } E_{out} = E_1 + \frac{(E' - E_{l,1})(E_K - E_1)}{(E_{l,K} - E_{l,1})} .$$

e. Fission Inelastic Scattering: For any fission reaction a number of neutrons,  $N_p$ , are emitted according to the value of  $\bar{\nu}(E_{in})$ . The average number of neutrons per fission,  $\bar{\nu}(E_{in})$ , is either a tabulated function of energy or a polynomial function of energy. If  $I$  is the largest integer less than  $\bar{\nu}(E_{in})$ , then

$$N_p = I + 1 \quad \text{if } \xi \leq \bar{\nu}(E_{in}) - I$$

$$N_p = I \quad \text{if } \xi > \bar{\nu}(E_{in}) - I , \text{ where } \xi \text{ is a random number.}$$

The type of emitted neutron, either delayed or prompt, is then determined from the ratio of delayed  $\bar{\nu}_D(E_{in})$  to total  $\bar{\nu}_{tot}(E_{in})$  as

if  $\xi \leq \bar{\nu}_D(E_{in})/\bar{\nu}_{tot}(E_{in})$ , produce a delayed neutron, or

if  $\xi > \bar{\nu}_D(E_{in})/\bar{\nu}_{tot}(E_{in})$ , produce a prompt neutron.

Each delayed fission neutron energy and time of emission is determined by sampling from the abundance of each decay group and then the appropriate decay constant for time and tabular emission distribution as specified in the evaluation is used.

The energy of each prompt fission neutron is determined from the emission law as specified in the evaluation. The three laws used for prompt fission neutron spectra are 7, 9, and 11. These laws are discussed in the preceding section, starting on page 2–44.

The direction of each emitted neutron is sampled independently from the appropriate angular distribution table by the procedure described on page 2–37.

The energy of each fission neutron is determined from the appropriate (that is, as specified in the evaluation) emission law. The three laws used for fission neutron spectra are 7, 9, and 11. These laws are discussed in the preceding section, starting on page 2–44. MCNP then models the transport of the first neutron out after storing all other neutrons in the bank.

### 6. The S(α,β) treatment

The S(α,β) thermal scattering treatment is a complete representation of thermal neutron scattering by molecules and crystalline solids. Two processes are allowed: (1) inelastic scattering with cross section  $\sigma_{in}$  and a coupled energy-angle representation derived from an ENDF/B S(α,β) scattering law, and (2) elastic scattering with no change in the outgoing neutron energy for solids with cross section  $\sigma_{el}$  and an angular treatment derived from lattice parameters. The elastic scattering treatment is chosen with probability  $\sigma_{el}/(\sigma_{el} + \sigma_{in})$ . This thermal scattering treatment also allows the representation of scattering by multiatomic molecules (for example, BeO).

For the inelastic treatment, the distribution of secondary energies is represented by a set of equally probable final energies (typically 16 or 32) for each member of a grid of initial energies from an upper limit of typically 4 eV down to  $10^{-5}$  eV, along with a set of angular data for each initial and final energy. The selection of a final energy  $E'$  given an initial energy  $E$  can be characterized by sampling from the distribution

$$pE' | (E_i < E < E_{i+1}) = \frac{1}{N} \sum_{j=1}^N \delta[E' - \rho E_{i,j} - (1 - \rho)E_{i+1,j}] ,$$

where  $E_i$  and  $E_{i+1}$  are adjacent elements on the initial energy grid,

$$\rho = \frac{E_{i+1} - E}{E_{i+1} - E_i} ,$$

$N$  is the number of equally probable final energies, and  $E_{ij}$  is the  $j^{\text{th}}$  discrete final energy for incident energy  $E_i$ .

## CHAPTER 2 PHYSICS

There are two allowed schemes for the selection of a scattering cosine following selection of a final energy and final energy index  $j$ . In each case, the  $(i,j)^{th}$  set of angular data is associated with the energy transition  $E = E_i \rightarrow E' = E_{i,j}$ .

(1.) The data consist of sets of equally probable discrete cosines  $\mu_{i,j,k}$  for  $k = 1, \dots, v$  with  $v$  typically 4 or 8. An index  $k$  is selected with probability  $1/v$ , and  $\mu$  is obtained by the relation

$$\mu = \rho \mu_{i,j,k} + (1 - \rho) \mu_{i+1,j,k} .$$

(2.) The data consist of bin boundaries of equally probable cosine bins. In this case, random linear interpolation is used to select one set or the other, with  $\rho$  being the probability of selecting the set corresponding to incident energy  $E_i$ . The subsequent procedure consists of sampling for one of the equally probable bins and then choosing  $\mu$  uniformly in the bin.

For elastic scattering, the above two angular representations are allowed for data derived by an incoherent approximation. In this case, one set of angular data appears for each incident energy and is used with the interpolation procedures on incident energy described above.

For elastic scattering, when the data have been derived in the coherent approximation, a completely different representation occurs. In this case, the data actually stored are the set of parameters  $D_k$ , where

$$\begin{aligned} \sigma_{eI} &= D_k/E \quad \text{for } E_{Bk} \leq E < E_{Bk+1} \\ \sigma_{eI} &= (0)/E \quad \text{for } E < E_{B1} \end{aligned}$$

and  $E_{Bk}$  are Bragg energies derived from the lattice parameters. For incident energy  $E$  such that  $E_{Bk} \leq E \leq E_{Bk+1}$ ,

$$P_i = D_i/D_k \quad \text{for } i = 1, \dots, k$$

represents a discrete cumulative probability distribution that is sampled to obtain index  $i$ , representing scattering from the  $i^{th}$  Bragg edge. The scattering cosine is then obtained from the relationship

$$\mu = 1 - 2E_{Bi}/E .$$

Using next event estimators such as point detectors with  $S(\alpha, \beta)$  scattering cannot be done exactly because of the discrete scattering angles. MCNP uses an approximate scheme<sup>42,43</sup> that in the next event estimation calculation replaces discrete lines with histograms of width

$$\delta\mu < .1 .$$

See also page 2-95.

## 7. Unresolved Resonance Range Probability Tables

Above the resonance range ( 2 - 25 keV for  $^{235}\text{U}$  in ENDF/B-VI, 10 - 300 keV for  $^{238}\text{U}$  in ENDF/B-VI), continuous-energy neutron cross sections appear to be smooth as a function of energy. This is not because the resonances end, but rather because the resonances are so close together that they are unresolved. The cross section can, however, be represented by probabilities. The unresolved resonance range probability table method provides a table of probabilities for the cross sections in the unresolved resonance energy range. Properly sampling unresolved resonances is important to properly model resonance self-shielding effects, particularly for fast-spectra nuclear systems such as unmoderated critical assemblies.

Sampling cross sections from probability tables is straightforward. At each of a number of incident energies there is a table of cumulative probabilities (typically 20) and the value of the near-total, elastic, fission, and radiative capture cross sections and heat deposition numbers corresponding to those probabilities. These data supplement the usual continuous data; if probability tables are turned off (PHYS:N card), then the usual smooth cross section is used. But if the probability tables are turned on (default), if they exist for the nuclide of a collision, and if the energy of the collision is in the unresolved resonance energy range of the probability tables, then the cross sections are sampled from the tables. The near-total is the total of the elastic, fission, and radiative capture cross sections; it is not the total cross section, which may include other absorption or inelastic scatter in addition to the near-total. The radiative capture cross section is not the same as the usual MCNP capture cross section, which is more properly called “destruction” or absorption and includes not only radiative capture but all other reactions not emitting a neutron. Sometimes the probability tables are provided as factors (multipliers of the average or underlying smooth cross section) which adds computational complexity but now includes any structure in the underlying smooth cross section.

It is essential to maintain correlations in the random walk when using probability tables to properly model resonance self-shielding. Suppose we sample the 17th level (probability) from the table for a given collision. This position in the probability table must be maintained for the neutron trajectory until the next collision, regardless of particle splitting for variance reduction or surface crossings into various other materials whose nuclides may or may not have probability table data. Correlation must also be retained in the unresolved energy range when two or more cross-section sets for an isotope that utilize probability tables are at different temperatures.

### *D. Photon Interactions*

Sampling of a collision nuclide, analog capture, implicit capture, and many other aspects of photon interactions such as variance reduction, are the same as for neutrons. The collision physics are completely different.

MCNP has two photon interaction models: simple and detailed.

## CHAPTER 2 PHYSICS

The simple physics treatment ignores coherent (Thomson) scattering and fluorescent photons from photoelectric absorption. It is intended for high-energy photon problems or problems where electrons are free and is also important for next event estimators such as point detectors, where scattering can be nearly straight ahead with coherent scatter. The simple physics treatment uses implicit capture unless overridden with the CUT:P card, in which case it uses analog capture.

The detailed physics treatment includes coherent (Thomson) scattering and accounts for fluorescent photons after photoelectric absorption. Form factors are used to account for electron binding effects. Analog capture is always used. The detailed physics treatment is used below energy EMCPF on the PHYS:P card, and because the default value of EMCPF is 100 MeV, that means it is almost always used by default. It is the best treatment for most applications, particularly for high Z nuclides or deep penetration problems.

The generation of electrons from photons is handled three ways. These three ways are the same for both the simple and detailed photon physics treatments. (1) If electron transport is turned on (Mode P E), then all photon collisions except coherent scatter can create electrons that are banked for later transport. (2) If electron transport is turned off (no E on the Mode card), then a thick-target bremsstrahlung model (TTB) is used. This model generates electrons, but assumes that they travel in the direction of the incident photon and that they are immediately annihilated. Any bremsstrahlung photons produced by the nontransported electrons are then banked for later transport. Thus electron-induced photons are not neglected, but the expensive electron transport step is omitted. (3) If IDES = 1 on the PHYS:P card, then all electron production is turned off, no electron-induced photons are created, and all electron energy is assumed to be locally deposited.

The TTB approximation cannot be used in Mode P E problems, but it is the default for Mode P problems.

### 1. Simple Physics Treatment

The simple physics treatment is intended primarily for higher energy photons. It is inadequate for high Z nuclides or deep penetration problems. The physical processes treated are photoelectric effect, pair production, and Compton scattering on free electrons. The photoelectric effect is regarded as an absorption (without fluorescence), scattering (Compton) is regarded to be on free electrons (without use of form factors), and the highly forward coherent Thomson scattering is ignored. Thus the total cross section  $\sigma_t$  is regarded as the sum of three components:

$$\sigma_t = \sigma_{pe} + \sigma_{pp} + \sigma_s \quad .$$

a. Photoelectric effect: This is treated as a pure absorption by implicit capture with a corresponding reduction in the photon weight  $WGT$ , and hence does not result in the loss of a particle history except for Russian roulette played on the weight cutoff. The noncaptured weight  $WGT(1 - \sigma_{pe}/\sigma_t)$  is then forced to undergo either pair production or Compton scattering. The captured weight either is assumed to be locally deposited or becomes a photoelectron for electron transport or for the TTB approximation.

b. Pair production: In a collision resulting in pair production [probability  $\sigma_{pp}/(\sigma_t - \sigma_{pe})$ ], either an electron-positron pair are created for further transport (or the TTB treatment) and the photon disappears, or it is assumed that the kinetic energy  $WGT(E - 1.022)$  MeV of the electron-positron pair produced is deposited as thermal energy at the time and point of collision, with isotropic production of one photon of energy 0.511 MeV headed in one direction and another photon of energy 0.511 MeV headed in the opposite direction. The rare single 1.022-MeV annihilation photon is ignored. The simple physics treatment for pair production is the same as the detailed physics treatment that is described in detail below.

c. Compton scattering: The alternative to pair production is Compton scattering on a free electron, with probability  $\sigma_s/(\sigma_t - \sigma_{pe})$ . In the event of such a collision, the objective is to determine the energy  $E'$  of the scattered photon, and  $\mu = \cos\theta$  for the angle  $\theta$  of deflection from the line of flight. This yields at once the energy  $WGT(E - E')$  deposited at the point of collision and the new direction of the scattered photon. The energy deposited at the point of collision can then be used to make a Compton recoil electron for further transport or for the TTB approximation.

The differential cross section for the process is given by the Klein-Nishina formula<sup>1</sup>

$$K(\alpha, \mu)d\mu = \pi r_o^2 \left(\frac{\alpha'}{\alpha}\right)^2 \left[ \frac{\alpha'}{\alpha} + \frac{\alpha}{\alpha'} + \mu^2 - 1 \right] d\mu , \quad (2.2)$$

where  $r_o$  is the classical electron radius  $2.817938 \times 10^{-13}$  cm,  $\alpha$  and  $\alpha'$  are the incident and final photon energies in units of 0.511 MeV [ $\alpha = E/(mc^2)$ , where  $m$  is the mass of the electron and  $c$  is the speed of light], and  $\alpha' = \alpha/[1 + \alpha(1 - \mu)]$ .

The Compton scattering process is sampled exactly by Kahn's method<sup>44</sup> below 1.5 MeV and by Koblinger's method<sup>45</sup> above 1.5 MeV as analyzed and recommended by Blomquist and Gelbard.<sup>46</sup>

For next event estimators such as detectors and DXTRAN, the probability density for scattering toward the detector point must be calculated:



## CHAPTER 2 PHYSICS

$$p(\mu) = \frac{1}{\sigma_1^K(Z, \alpha)} K(\alpha, \mu) ,$$

where  $\sigma_1^K(Z, \alpha)$  is the total Klein-Nishina cross section obtained by integrating  $K(\alpha, \mu)$  over all angles for energy  $\alpha$ . This is a difficult integration, so the empirical formula of Hastings<sup>2</sup> is used:

$$\sigma_1^K(Z, \alpha) = \pi r_o^2 \frac{c_1 \eta^2 + c_2 \eta + c_3}{\eta^3 + d_1 \eta^2 + d_2 \eta + d_3} ,$$

where  $\eta = 1 + .222037a$ ,  $c1 = 1.651035$ ,  $c2 = 9.340220$ ,  $c3 = -8.325004$ ,  $d1 = 12.501332$ ,  $d2 = -14.200407$ , and  $d3 = 1.699075$ . Thus,

$$p(\mu) = \frac{\eta^3 + d_1 \eta^2 + d_2 \eta + d_3}{c_1 \eta^2 + c_2 \eta + c_3} \left( \frac{\alpha'}{\alpha} \right)^2 \left( \frac{\alpha'}{\alpha} + \frac{\alpha'}{\alpha} + \mu^2 - 1 \right) .$$

Above 100 MeV, where the Hastings fit is no longer valid, the approximation

$$\sigma_1^K(Z, \alpha) = \sigma_1(Z, \alpha)/Z$$

is made so that

$$p(\mu) = \frac{Z \pi r_o^2}{\sigma_1(Z, \alpha)} \left( \frac{\alpha'}{\alpha} \right)^2 \left( \frac{\alpha'}{\alpha} + \frac{\alpha'}{\alpha} + \mu^2 - 1 \right) .$$

### 2. Detailed Physics Treatment

The detailed physics treatment includes coherent (Thomson) scattering and accounts for fluorescent photons after photoelectric absorption. Form factors are used with coherent and incoherent scattering to account for electron binding effects. Analog capture is always used, as described below under photoelectric effect. The detailed physics treatment is used below energy EMC PF on the PHYS:P card, and because the default value of EMC PF is 100 MeV, that means it is almost always used by default. It is the best treatment for most applications, particularly for high Z nuclides or deep penetration problems.

The detailed physics treatment for next event estimators such as point detectors is inadvisable, as explained on page 2-62, unless the NOCOH=1 option is used on the PHYS:P card to turn off coherent scattering.

a. Incoherent (Compton) scattering: To model Compton scattering it is necessary to determine the angle  $\theta$  of scattering from the incident line of flight (and thus the new direction),

the new energy  $E'$  of the photon, and the recoil kinetic energy of the electron,  $E-E'$ . The recoil kinetic energy can be deposited locally, can be transported in Mode P E problems, or (default) can be treated with the TTB approximation.

Incoherent scattering is assumed to have the differential cross section

$\sigma_I(Z, \alpha, \mu)d\mu = I(Z, \nu)K(\alpha, \mu)d\mu$ , where  $I(Z, \nu)$  is an appropriate scattering factor modifying the Klein-Nishina cross section in Eq. (2.2).

Qualitatively, the effect of  $I(Z, \nu)$  is to decrease the Klein-Nishina cross section (per electron) more extremely in the forward direction, for low  $E$  and for high  $Z$  independently. For any  $Z$ ,  $I(Z, \nu)$  increases from  $I(Z, 0) = 0$  to  $I(Z, \infty) = Z$ . The parameter  $\nu$  is the inverse length  $\nu = \sin(\theta/2)/\lambda = \kappa\alpha\sqrt{1-\mu}$  where  $\kappa = 10^{-8} m_o c / (h\sqrt{2}) = 29.1445 \text{ cm}^{-1}$ . The maximum value of  $\nu$  is  $\nu_{max} = \kappa\alpha\sqrt{2} = 41.2166$  at  $\mu = -1$ . The essential features of  $I(Z, \nu)$  are indicated in Fig. 2-4.

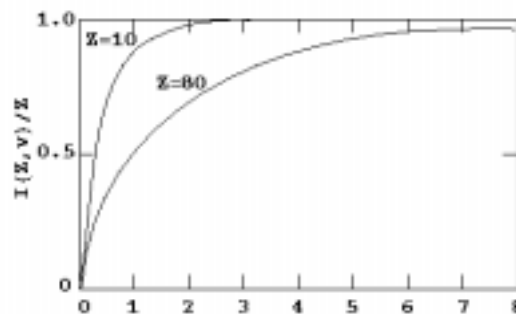

Figure 2-4.

For hydrogen, an exact expression for the form factor is used:<sup>47</sup>

$$I(1, \nu) = 1 - \frac{1}{\left(1 + \frac{1}{2}f^2\nu^2\right)^4},$$

where  $f$  is the inverse fine structure constant,  $f = 137.0393$ , and  $f/\sqrt{2} = 96.9014$ .

The Klein-Nishina formula is sampled exactly by Kahn's method<sup>44</sup> below 1.5 MeV and by Koblinger's method<sup>45</sup> above 1.5 MeV as analyzed and recommended by Blomquist and Gelbard.<sup>46</sup> The outgoing energy  $E'$  and angle  $\mu$  are rejected according to the form factors.

For next event estimators such as detectors and DXTRAN, the probability density for scattering toward the detector point must be calculated:

**CHAPTER 2  
PHYSICS**

$$p(\mu) = \frac{1}{\sigma_1(Z, \alpha)} I(Z, \nu) K(\alpha, \mu) = \frac{\pi r_o^2}{\sigma_1(Z, \alpha)} I(Z, \nu) \left(\frac{\alpha'}{\alpha}\right)^2 \left(\frac{\alpha}{\alpha'} + \frac{\alpha'}{\alpha} + \mu^2 - 1\right) .$$

where  $\pi r_o^2 = 2494351$  and  $\sigma_1(Z, \alpha)$  and  $I(Z, \nu)$  are looked up in the data library.

b. Coherent (Thomson) scattering: Thomson scattering involves no energy loss, and thus is the only photon process that cannot produce electrons for further transport and that cannot use the TTB approximation. Only the scattering angle  $\theta$  is computed, and then the transport of the photon continues.

The differential cross section is  $\sigma_2(Z, \alpha, \mu)d\mu = C^2(Z, \nu)T(\mu)d\mu$ , where  $C(Z, \nu)$  is a form factor modifying the energy-independent Thomson cross section  $T(\mu) = \pi r_o^2(1 + \mu^2)d\mu$ .

The general effect of  $C^2(Z, \nu)/Z^2$  is to decrease the Thomson cross section more extremely for backward scattering, for high  $E$ , and low  $Z$ . This effect is opposite in these respects to the effect of  $I(Z, \nu)/Z$  on  $K(\alpha, \mu)$  in incoherent (Compton) scattering. For a given  $Z$ ,  $C(Z, \nu)$  decreases from  $C(Z, 0) = Z$  to  $C(Z, \infty) = 0$ . For example,  $C(Z, \nu)$  is a rapidly decreasing function of  $\mu$  as  $\mu$  varies from +1 to -1, and therefore the coherent cross section is peaked in the forward direction. At high energies of the incoming photon, coherent scattering is strongly forward and can be ignored. The parameter  $\nu$  is the inverse length  $\nu = \sin(\theta/2)/\lambda = \kappa\alpha\sqrt{1 - \mu}$  where  $\kappa = 10^{-8} m_o c / (h\sqrt{2}) = 29.1445 cm^{-1}$ . The maximum value of  $\nu$  is  $\nu_{max} = \kappa\alpha\sqrt{2} = 41.2166\alpha$  at  $\mu = -1$ . The square of the maximum value is  $\nu_{max}^2 = 1698.8038\alpha^2$ . The qualitative features of  $C(Z, \nu)$  are shown in Fig. 2-5.

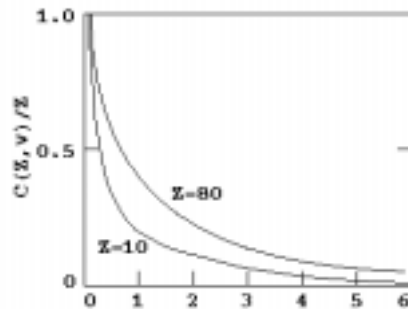

**Figure 2-5.**

For next event estimators, one must evaluate the probability density function  $p(\mu) = \pi r_o^2(1 + \mu^2)C^2(Z, \nu)/\sigma_2(Z, \alpha)$  for given  $\mu$ . Here  $\sigma_2(Z, \alpha)$  is the integrated coherent cross section. The value of  $C^2(Z, \nu)$  at  $\nu = \kappa\alpha\sqrt{1 - \mu}$  must be interpolated in the original  $C^2(Z, \nu_i)$  tables separately stored on the cross-section library for this purpose.

Note that at high energies, coherent scattering is virtually straight ahead with no energy loss; thus, it appears from a transport viewpoint that no scattering took place. For a point detector to sample this scattering, the point must lie on the original track ( $\mu \cong 1$ ), which is seldom the case. Thus, photon point detector variances generally will be much greater with detailed photon physics than with simple physics unless coherent scattering is turned off with NOCOH = 1 on the PHYS:P card, as explained on page 2–62.

c. **Photoelectric effect:** The photoelectric effect consists of the absorption of the incident photon of energy  $E$ , with the consequent emission of several fluorescent photons and the ejection (or excitation) of an orbital electron of binding energy  $e < E$ , giving the electron a kinetic energy of  $E - e$ . Zero, one, or two fluorescent photons are emitted. These three cases are now described.

(1) Zero photons greater than 1 keV are emitted. In this event, the cascade of electrons that fills up the orbital vacancy left by the photoelectric ejection produces electrons and low-energy photons (Auger effect). These particles can be followed in Mode P E problems, or be treated with the TTB approximation, or be assumed to deposit energy locally. Because no photons are emitted by fluorescence (some may be produced by electron transport or the TTB model), the photon track is terminated. This photoelectric “capture” of the photon is scored like analog capture in the summary table of the output file. Implicit capture is not possible.

(2) One fluorescent photon of energy greater than 1 keV is emitted. The photon energy  $E'$  is the difference in incident photon energy  $E$ , less the ejected electron kinetic energy  $E - e$ , less a residual excitation energy  $e'$  that is ultimately dissipated by further Auger processes. This dissipation leads to additional electrons or photons of still lower energy. The ejected electron and any Auger electrons can be transported or treated with the TTB approximation. In general,

$$E' = E - (E - e) - e' = e - e'.$$

These primary transactions are taken to have the full fluorescent yield from all possible upper levels  $e'$ , but are apportioned among the x-ray lines  $K\alpha_1$ , ( $L_3 \rightarrow K$ );  $K\alpha_2$ , ( $L_2 \rightarrow K$ );  $K\beta'_1$ , (mean  $M \rightarrow K$ ); and  $k\beta'_2$ , (mean  $N \rightarrow K$ ).

(3) Two fluorescence photons can occur if the residual excitation  $e'$  of process (2) exceeds 1 keV. An electron of binding energy  $e''$  can fill the orbit of binding energy  $e'$ , emitting a second fluorescent photon of energy  $E'' = e' - e''$ . As before, the residual excitation  $e''$  is dissipated by further Auger events and electron production that can be modeled with electron transport in Mode P E calculations, approximated with the TTB model, or assumed to deposit all energy locally. These secondary transitions come from all upper shells and go to  $L$  shells. Thus the primary transitions must be  $K\alpha_1$  or  $K\alpha_2$  to leave an  $L$  shell vacancy.

Each fluorescent photon born as discussed above is assumed to be emitted isotropically and is transported, provided that  $E'$ ,  $E'' > 1 \text{ keV}$ . The binding energies  $e$ ,  $e'$ , and  $e''$  are very nearly

## CHAPTER 2 PHYSICS

the x-ray absorption edges because the x-ray absorption cross section takes an abrupt jump as it becomes energetically possible to eject (or excite) the electron of energy first  $E \cong e''$ , then  $e'$ , then  $e$ , etc. The jump can be as much as a factor of 20 (for example, K-carbon).

A photoelectric event is terminal for elements  $Z < 12$  because the possible fluorescence energy is below 1 keV. The event is only a single fluorescence of energy above 1 keV for  $31 > Z \geq 12$ , but double fluorescence (each above 1 keV) is possible for  $Z \geq 31$ . For  $Z \geq 31$ , primary lines  $K\alpha_1$ ,  $K\alpha_2$ , and  $K\beta'_1$  are possible and, in addition, for  $Z \geq 37$ , the  $K\beta'_2$  line is possible.

In all photoelectric cases where the photon track is terminated because either no fluorescent photons are emitted or the ones emitted are below the energy cutoff, the termination is considered to be caused by analog capture in the output file summary table (and not energy cutoff).

**d. Pair Production:** This process is considered only in the field of a nucleus. The threshold is  $2mc^2[1 + (m/M)] \cong 1.022$  MeV, where  $M$  is the nuclear mass and  $m$  is the mass of the electron. There are three cases:

(1) In the case of electron transport (Mode P E), the electron and positron are created and banked and the photon track terminates.

(2) For Mode P problems with the TTB approximation, both an electron and positron are produced but not transported. Both particles can make TTB approximation photons. If the positron is below the electron energy cutoff, then it is not created and a photon pair is created as in case (3).

(3) For Mode P problems when positrons are not created by the TTB approximation, the incident photon of energy  $E$  vanishes. The kinetic energy of the created positron/electron pair, assumed to be  $E - 2mc^2$ , is deposited locally at the collision point. The positron is considered to be annihilated with an electron at the point of collision, resulting in a pair of photons, each with the incoming photon weight, and each with an energy of  $mc^2 = 0.511$  MeV. The first photon is emitted isotropically, and the second is emitted in the opposite direction. The very rare single-annihilation photon of 1.022 MeV is omitted.

**e. Caution for detectors and coherent scattering:** The use of the detailed photon physics treatment is not recommended for photon next event estimators (such as point detectors and ring detectors) nor for DXTRAN, unless coherent scatter is turned off with the NOCOH = 1 option on the PHYS:P card. Alternatively, the simple physics treatment (EMCPF < .001 on the PHYS:P card) can be used. Turning off coherent scattering can improve the figure of merit (see page 2-108) by more than a factor of 10 for tallies with small relative errors because coherent scattering is highly peaked in the forward direction. Consequently, coherent scattering becomes undersampled because the photon must be traveling directly at the detector point and undergo

coherent scattering event. When the photon is traveling nearly in the direction of the point detector or the chosen point on a ring detector or DXTRAN sphere, the PSC term,  $p(\mu)$ , of the point detector (see page 2–85) becomes very large, causing a huge score for the event and severely affecting the tally. Remember that  $p(\mu)$  is not a probability (that can be no larger than unity); it is a probability density function (the derivative of the probability) and can approach infinity for highly forward-peaked scattering. Thus the undersampled coherent scattering event is characterized by many low scores to the detector when the photon trajectory is away from the detector ( $p(\mu) = \textit{small}$ ) and a very few very large scores ( $p(\mu) = \textit{huge}$ ) when the trajectory is nearly aimed at the detector. Such undersampled events cause a sudden increase in both the tally and the variance, a sudden drop in the figure of merit, and a failure to pass the statistical checks for the tally as described on page 2–121.

### *E. Electron Interactions*

The transport of electrons and other charged particles is fundamentally different from that of neutrons and photons. The interaction of neutral particles is characterized by relatively infrequent isolated collisions, with simple free flight between collisions. By contrast, the transport of electrons is dominated by the long-range Coulomb force, resulting in large numbers of small interactions. As an example, a neutron in aluminum slowing down from 0.5 MeV to 0.0625 MeV will have about 30 collisions, while a photon in the same circumstances will experience fewer than ten. An electron accomplishing the same energy loss will undergo about  $10^5$  individual interactions. This great increase in computational complexity makes a single-collision Monte Carlo approach to electron transport unfeasible for most situations of practical interest.

Considerable theoretical work has been done to develop a variety of analytic and semi-analytic multiple-scattering theories for the transport of charged particles. These theories attempt to use the fundamental cross sections and the statistical nature of the transport process to predict probability distributions for significant quantities, such as energy loss and angular deflection. The most important of these theories for the algorithms in MCNP are the Goudsmit-Saunderson<sup>48</sup> theory for angular deflections, the Landau<sup>49</sup> theory of energy-loss fluctuations, and the Blunck-Leisegang<sup>50</sup> enhancements of the Landau theory. These theories rely on a variety of approximations that restrict their applicability, so that they cannot solve the entire transport problem. In particular, it is assumed that the energy loss is small compared to the kinetic energy of the electron.

In order to follow an electron through a significant energy loss, it is necessary to break the electron's path into many steps. These steps are chosen to be long enough to encompass many collisions (so that multiple-scattering theories are valid) but short enough that the mean energy loss in any one step is small (so that the approximations necessary for the multiple-scattering theories are satisfied). The energy loss and angular deflection of the electron during each of the steps can then be sampled from probability distributions based on the appropriate multiple-

## CHAPTER 2 PHYSICS

scattering theories. This subsumption of the effects of many individual collisions into single steps that are sampled probabilistically constitutes the “condensed history” Monte Carlo method.

The most influential reference for the condensed history method is the 1963 paper by Martin J. Berger.<sup>51</sup> Based on the techniques described in that work, Berger and Stephen M. Seltzer developed the ETRAN series of electron/photon transport codes.<sup>52</sup> These codes have been maintained and enhanced for many years at the National Bureau of Standards (now the National Institute of Standards and Technology). The ETRAN codes are also the basis for the Integrated TIGER Series,<sup>53</sup> a system of general-purpose, application-oriented electron/photon transport codes developed and maintained by John A. Halbleib and his collaborators at Sandia National Laboratories in Albuquerque, New Mexico. The electron physics in MCNP is essentially that of the Integrated TIGER Series.

### 1. Electron Steps and Substeps

The condensed random walk for electrons can be considered in terms of a sequence of sets of values

$$(0, E_0, t_0, \mathbf{u}_0, \mathbf{r}_0), (s_1, E_1, t_1, \mathbf{u}_1, \mathbf{r}_1), (s_2, E_2, t_2, \mathbf{u}_2, \mathbf{r}_2), \dots$$

where  $s_n$ ,  $E_n$ ,  $t_n$ ,  $\mathbf{u}_n$ , and  $\mathbf{r}_n$  are the total path length, energy, time, direction, and position of the electron at the end of  $n$  steps. On the average, the energy and path length are related by

$$E_{n-1} - E_n = - \int_{s_{n-1}}^{s_n} \frac{dE}{ds} ds \quad , \quad (2.3)$$

where  $-dE/ds$  is the total stopping power in energy per unit length. This quantity depends on energy and on the material in which the electron is moving. ETRAN-based codes customarily choose the sequence of path lengths  $\{s_n\}$  such that

$$\frac{E_n}{E_{n-1}} = k \quad , \quad (2.4)$$

for a constant  $k$ . The most commonly used value is  $k = 2^{-1/8}$ , which results in an average energy loss per step of 8.3%.

Electron steps with (energy-dependent) path lengths  $s = s_n - s_{n-1}$  determined by Eqs. 2.3-2.4 are called *major steps* or *energy steps*. The condensed random walk for electrons is structured in terms of these energy steps. For example, all precalculated and tabulated data for electrons are stored on an energy grid whose consecutive energy values obey the ratio in Eq. 2.4. In addition, the Landau and Blunck-Leisegang theories for energy straggling are applied once per energy

step. For a single step, the angular scattering could also be calculated with satisfactory accuracy, since the Goudsmit-Saunders theory is valid for arbitrary angular deflections. However, the representation of the electron's trajectory as the result of many small steps will be more accurate if the angular deflections are also required to be small. Therefore, the ETRAN codes and MCNP further break the electron steps into smaller substeps. A major step of path length  $s$  is divided into  $m$  substeps, each of path length  $s/m$ . Angular deflections and the production of secondary particles are sampled at the level of these substeps. The integer  $m$  depends only on material (average atomic number  $Z$ ). Appropriate values for  $m$  have been determined empirically, and range from  $m = 2$  for  $Z < 6$  to  $m = 15$  for  $Z > 91$ .

In some circumstances, it may be desirable to increase the value of  $m$  for a given material. In particular, a very small material region may not accommodate enough substeps for an accurate simulation of the electron's trajectory. In such cases, the user can increase the value of  $m$  with the ESTEP option on the material card. The user can gain some insight into the selection of  $m$  by consulting Print Table 85 in the MCNP output. Among other information, this table presents a quantity called DRANGE as a function of energy. DRANGE is the size of an energy step in  $\text{g}/\text{cm}^2$ . Therefore,  $\text{DRANGE}/m$  is the size of a substep in the same units, and if  $\rho$  is the material density in  $\text{g}/\text{cm}^3$ , then  $\text{DRANGE}/(m\rho)$  is the length of a substep in cm. This quantity can be compared with the smallest dimension of a material region. A reasonable rule of thumb is that an electron should make at least ten substeps in any material of importance to the transport problem.

## 2. Condensed Random Walk

In the initiation phase of a transport calculation involving electrons, all relevant data are either precalculated or read from the electron data file and processed. These data include the electron energy grid, stopping powers, electron ranges, energy step ranges, substep lengths, and probability distributions for angular deflections and the production of secondary particles. Although the energy grid and electron steps are selected according to Eqs. 2.3-2.4, energy straggling, the analog production of bremsstrahlung, and the intervention of geometric boundaries and the problem time cutoff will cause the electron's energy to depart from a simple sequence  $s_n$  satisfying Eq. 2.4. Therefore, the necessary parameters for sampling the random walk will be interpolated from the points on the energy grid.

At the beginning of each major step, the collisional energy loss rate is sampled. In the absence of energy straggling, this will be a simple average value based on the nonradiative stopping power described in the next section. In general, however, fluctuations in the energy loss rate will occur. The number of substeps  $m$  per energy step will have been preset, either from the empirically-determined default values, or by the user, based on geometric considerations. At most  $m$  substeps will be taken in the current major step, i. e., with the current value for the energy loss rate. The number of substeps may be reduced if the electron's energy falls below the boundary of the current major step, or if the electron reaches a geometric boundary. In these



## CHAPTER 2 PHYSICS

circumstances, or upon the completion of  $m$  substeps, a new major step is begun, and the energy loss rate is resampled.

Except for the energy loss and straggling calculation, the detailed simulation of the electron history takes place in the sampling of the substeps. The Goudsmit-Saunderson<sup>48</sup> theory is used to sample from the distribution of angular deflections, so that the direction of the electron can change at the end of each substep. Based on the current energy loss rate and the substep length, the projected energy for the electron at the end of the substep is calculated. Finally, appropriate probability distributions are sampled for the production of secondary particles. These include electron-induced fluorescent X-rays, “knock-on” electrons (from electron-impact ionization), and bremsstrahlung photons.

Note that the length of the substep ultimately derives from the total stopping power used in Eq. 2.3, but the projected energy loss for the substep is based on the nonradiative stopping power. The reason for this difference is that the sampling of bremsstrahlung photons is treated as an essentially analog process. When a bremsstrahlung photon is generated during a substep, the photon energy is subtracted from the projected electron energy at the end of the substep. Thus the radiative energy loss is explicitly taken into account, in contrast to the collisional (nonradiative) energy loss, which is treated probabilistically and is not correlated with the energetics of the substep. Two biasing techniques are available to modify the sampling of bremsstrahlung photons for subsequent transport. However, these biasing methods do not alter the linkage between the analog bremsstrahlung energy and the energetics of the substep.

MCNP uses identical physics for the transport of electrons and positrons, but distinguishes between them for tallying purposes, and for terminal processing. Electron and positron tracks are subject to the usual collection of terminal conditions, including escape (entering a region of zero importance), loss to time cutoff, loss to a variety of variance-reduction processes, and loss to energy cutoff. The case of energy cutoff requires special processing for positrons, which will annihilate at rest to produce two photons, each with energy  $m c^2 = 0.511008$  MeV.

### 3. Stopping Power

#### 3a. Collisional Stopping Power

Berger<sup>51</sup> gives the restricted electron collisional stopping power, i. e., the energy loss per unit path length to collisions resulting in fractional energy transfers  $\epsilon$  less than an arbitrary maximum value  $\epsilon_m$ , in the form

$$-\left(\frac{dE}{ds}\right)_{\epsilon_m} = NZC \left\{ \ln \frac{E^2(\tau + 2)}{2I^2} + f^-(\tau, \epsilon_m) - \delta \right\}, \quad (2.5)$$

where

$$f^-(\tau, \epsilon_m) = -1 - \beta^2 + \left(\frac{\tau}{\tau+1}\right)^2 \frac{\epsilon_m^2}{2} + \frac{2\tau+1}{(\tau+1)^2} \ln(1 - \epsilon_m) \quad (2.6)$$

$$+ \ln[4\epsilon_m(1 - \epsilon_m)] + \frac{1}{1 - \epsilon_m} .$$

Here  $\epsilon$  and  $\epsilon_m$  represent energy transfers as fractions of the electron kinetic energy  $E$ ;  $I$  is the mean ionization potential in the same units as  $E$ ;  $\beta$  is  $v/c$ ;  $\tau$  is the electron kinetic energy in units of the electron rest mass;  $\delta$  is the density effect correction (related to the polarization of the medium);  $Z$  is the average atomic number of the medium;  $N$  is the atom density of the medium in  $\text{cm}^{-3}$ ; and the coefficient  $C$  is given by

$$C = \frac{2\pi e^4}{mv^2} , \quad (2.7)$$

where  $m$ ,  $e$ , and  $v$  are the rest mass, charge, and speed of the electron, respectively. The density effect correction  $\delta$  is calculated using the prescriptions of Sternheimer, Berger and Seltzer<sup>54</sup> in the e103 evaluation and using the method of Sternheimer and Peierls<sup>55</sup> for the e11 evaluation.

The ETRAN codes and MCNP do not make use of restricted stopping powers, but rather treat all collisional events in an uncorrelated, probabilistic way. Thus, only the total energy loss to collisions is needed, and Eqs. 2.5-2-6 can be evaluated for the special value  $\epsilon_m = 1/2$ . The reason for the  $1/2$  is the indistinguishability of the two outgoing electrons. The electron with the larger energy is, by definition, the primary. Therefore, only the range  $\epsilon < 1/2$  is of interest. With  $\epsilon_m = 1/2$ , Eq. 2.6 becomes

$$f^-(\tau, \epsilon_m) = -\beta^2 + (1 - \ln 2) + \left(\frac{1}{8} + \ln 2\right) \left(\frac{\tau}{\tau+1}\right)^2 . \quad (2.8)$$

On the right side of Eq. 2.5, we can express both  $E$  and  $I$  in units of the electron rest mass. Then  $E$  can be replaced by  $\tau$  on the right side of the equation. We also introduce supplementary constants

$$C2 = \ln(2I^2) ,$$

$$C3 = 1 - \ln 2 , \quad (2.9)$$

$$C4 = \frac{1}{8} + \ln 2 ,$$

## CHAPTER 2 PHYSICS

so that Eq. 2.5 becomes

$$-\left(\frac{dE}{ds}\right) = NZ \frac{2\pi e^4}{mv^2} \left\{ \ln[\tau^2(\tau + 2)] - C2 + C3 - \beta^2 + C4 \left(\frac{\tau}{\tau + 1}\right)^2 - \delta \right\} \quad (2.10)$$

This is the collisional energy loss rate in MeV/cm in a particular medium. In MCNP, we are actually interested in the energy loss rate in units of MeV barns (so that different cells containing the same material need not have the same density). Therefore, we divide Eq. 2.10 by  $N$  and multiply by the conversion factor  $10^{24}$  barns/cm<sup>2</sup>. We also use the definition of the fine structure constant

$$\alpha = \frac{2\pi e^2}{hc} ,$$

where  $h$  is Planck's constant, to eliminate the electronic charge  $e$  from Eq. 2.10. The result is as follows:

$$-\left(\frac{dE}{ds}\right) = \frac{10^{24} \alpha^2 h^2 c^2}{2\pi m c^2} Z \left\{ \ln[\tau^2(\tau + 2)] - C2 + C3 - \beta^2 + C4 \left(\frac{\tau}{\tau + 1}\right)^2 - \delta \right\} \frac{1}{\beta^2} \quad (2.11)$$

This is the form actually used in MCNP to preset the collisional stopping powers at the energy boundaries of the major energy steps.

The mean ionization potential and density effect correction depend upon the state of the material, either gas or solid. In the fit of Sternheimer and Peierls<sup>55</sup> the physical state of the material also modifies the density effect calculation. In the Sternheimer, Berger and Seltzer<sup>54</sup> treatment, the calculation of the density effect uses the conduction state of the material to determine the contribution of the outermost conduction electron to the ionization potential. The occupation numbers and atomic binding energies used in the calculation are from Carlson.<sup>56</sup>

### 3b. Radiative Stopping Power

The radiative stopping power is

$$\left. \frac{dE}{ds} \right|_{rad} = 10^{24} Z(Z + \bar{\eta}) (\alpha r_e^2) (T + mc^2) \Phi_{rad}^{(n)}$$

where  $\Phi_{rad}^{(n)}$  is the scaled electron-nucleus radiative energy-loss cross section based upon evaluations by Berger and Seltzer for either e11 and e103 (details of the numerical values of the

el03 evaluation can be found in Ref. 57, Ref. 58, and Ref. 59;  $\bar{\eta}$  is a parameter to account for the effect of electron-electron bremsstrahlung (it is unity in the el1 evaluation and, in the el03 evaluation, it is based upon the work of S. Seltzer and M. Berger<sup>57,58,59</sup> and can be different from unity);  $\alpha$  is the fine structure constant,  $mc^2$  is the mass energy of an electron, and  $r_e$  is the classical electron radius. The dimensions of the radiative stopping power are the same as the collisional stopping power.

#### 4. Energy Straggling

Because an energy step represents the cumulative effect of many individual random collisions, fluctuations in the energy loss rate will occur. Thus the energy loss will not be a simple average  $\bar{\Delta}$ ; rather there will be a probability distribution  $f(s, \Delta) d\Delta$  from which the energy loss  $\Delta$  for the step of length  $s$  can be sampled. Landau<sup>49</sup> studied this situation under the simplifying assumptions that the mean energy loss for a step is small compared with the electron's energy, that the energy parameter  $\xi$  defined below is large compared with the mean excitation energy of the medium, that the energy loss can be adequately computed from the Rutherford<sup>60</sup> cross section, and that the formal upper limit of energy loss can be extended to infinity. With these simplifications, Landau found that the energy loss distribution can be expressed as

$$f(s, \Delta)d\Delta = \phi(\lambda)d\lambda$$

in terms of  $\phi(\lambda)$ , a universal function of a single scaled variable

$$\lambda = \frac{\Delta}{\xi} - \ln \left[ \frac{2\xi m v^2}{(1 - \beta^2) I^2} \right] + \delta + \beta^2 - 1 + \gamma.$$

Here  $m$  and  $v$  are the mass and speed of the electron,  $\delta$  is the density effect correction,  $\beta$  is  $v/c$ ,  $I$  is the mean excitation energy of the medium, and  $\gamma$  is Euler's constant ( $\gamma = 0.5772157\dots$ ). The parameter  $\xi$  is defined by

$$\xi = \frac{2\pi e^4 N Z}{m v^2} s,$$

where  $e$  is the charge of the electron and  $N Z$  is the number density of atomic electrons, and the universal function is

$$\phi(\lambda) = \frac{1}{2\pi i} \int_{x-i\infty}^{x+i\infty} e^{\mu \ln \mu + \lambda \mu} d\mu,$$

where  $x$  is a positive real number specifying the line of integration.

## CHAPTER 2 PHYSICS

For purposes of sampling,  $\phi(\lambda)$  is negligible for  $\lambda < -4$ , so that this range is ignored. Börsch-Supan<sup>61</sup> originally tabulated  $\phi(\lambda)$  in the range  $-4 \leq \lambda \leq 100$ , and derived for the range  $\lambda > 100$  the asymptotic form

$$\phi(\lambda) \approx \frac{1}{w^2 + \pi^2},$$

in terms of the auxiliary variable  $w$ , where

$$\lambda = w + \ln w + \gamma - \frac{3}{2}.$$

Recent extensions<sup>62</sup> of Börsch-Supan's tabulation have provided a representation of the function in the range  $-4 \leq \lambda \leq 100$  in the form of five thousand equally probable bins in  $\lambda$ . In MCNP, the boundaries of these bins are saved in the array `eqbm(mlam)`, where `mlam` = 5001. Sampling from this tabular distribution accounts for approximately 98.96% of the cumulative probability for  $\phi(\lambda)$ . For the remaining large- $\lambda$  tail of the distribution, MCNP uses the approximate form  $\phi(\lambda) \approx w^{-2}$ , which is easier to sample than  $(w^2 + \pi^2)^{-1}$ , but is still quite accurate for  $\lambda > 100$ .

Blunck and Leisegang<sup>50</sup> have extended Landau's result to include the second moment of the expansion of the cross section. Their result can be expressed as a convolution of Landau's distribution with a Gaussian distribution:

$$f^*(s, \Delta) = \frac{1}{\sqrt{2\pi}\sigma} \int_{-\infty}^{+\infty} f(s, \Delta') \exp\left[-\frac{(\Delta - \Delta')^2}{2\sigma^2}\right] d\Delta'.$$

Blunck and Westphal<sup>63</sup> provided a simple form for the variance of the Gaussian:

$$\sigma_{BW}^2 = 10eV \cdot Z^{4/3} \bar{\Delta}.$$

Subsequently, Chechin and Ermilova<sup>64</sup> investigated the Landau/Blunck-Leisegang theory, and derived an estimate for the relative error

$$\varepsilon_{CE} \approx \left[ \frac{10\xi}{I} \left( 1 + \frac{\xi}{10I} \right)^3 \right]^{-\frac{1}{2}}$$

caused by the neglect of higher-order moments. Based on this work, Seltzer<sup>65</sup> describes and recommends a correction to the Blunck-Westphal variance:

$$\sigma = \frac{\sigma_{BW}}{1 + 3\varepsilon_{CE}} .$$

This value for the variance of the Gaussian is used in MCNP.

Examination of the asymptotic form for  $\phi(\lambda)$  shows that unrestricted sampling of  $\lambda$  will not result in a finite mean energy loss. Therefore, a material- and energy-dependent cutoff  $\lambda_c$  is imposed on the sampling of  $\lambda$ . In the initiation phase of an MCNP calculation, the code makes use of two preset arrays, **flam(mlanc)** and **avlm(mlanc)**, with **mlanc** = 1591. The array **flam** contains candidate values for  $\lambda_c$  in the range  $-4 \leq \lambda_c \leq 50000$ ; the array **avlm** contains the corresponding expected mean values for the sampling of  $\lambda$ . For each material and electron energy, the code uses the known mean collisional energy loss  $\bar{\Delta}$ , interpolating in this tabular function to select a suitable value for  $\lambda_c$ , which is then stored in the dynamically-allocated array **flc**. During the transport phase of the calculation, the value of **flc** applicable to the current material and electron energy is used as an upper limit, and any sampled value of  $\lambda$  greater than the limit is rejected. In this way, the correct mean energy loss is preserved.

### 5. Angular Deflections

The ETRAN codes and MCNP rely on the Goudsmit-Saunderson<sup>48</sup> theory for the probability distribution of angular deflections. The angular deflection of the electron is sampled once per substep according to the distribution

$$F(s, \mu) = \sum_{l=0}^{\infty} \left( l + \frac{1}{2} \right) \exp(-sG_l) P_l(\mu) ,$$

where  $s$  is the length of the substep,  $\mu = \cos\theta$  is the angular deflection from the direction at the beginning of the substep,  $P_l(\mu)$  is the  $l^{\text{th}}$  Legendre polynomial, and  $G_l$  is

$$G_l = 2\pi N \int_{-1}^{+1} \frac{d\sigma}{d\Omega} [1 - P_l(\mu)] d\mu ,$$

in terms of the microscopic cross section  $d\sigma/d\Omega$ , and the atom density  $N$  of the medium.

For electrons with energies below 0.256 MeV, the microscopic cross section is taken from numerical tabulations developed from the work of Riley.<sup>66</sup> For higher-energy electrons, the microscopic cross section is approximated as a combination of the Mott<sup>67</sup> and Rutherford<sup>60</sup> cross sections, with a screening correction. Seltzer<sup>52</sup> presents this “factored cross section” in the form

## CHAPTER 2 PHYSICS

$$\frac{d\sigma}{d\Omega} = \frac{Z^2 e^2}{p^2 v^2 (1 - \mu + 2\eta)^2} \left[ \frac{(d\sigma/d\Omega)_{Mott}}{(d\sigma/d\Omega)_{Rutherford}} \right],$$

where  $e$ ,  $p$ , and  $v$  are the charge, momentum, and speed of the electron, respectively. The screening correction  $\eta$  was originally given by Molière<sup>68</sup> as

$$\eta = \frac{1}{4} \left( \frac{\alpha mc}{0.885 p} \right)^2 Z^{2/3} [1.13 + 3.76(\alpha Z/\beta)^2],$$

where  $\alpha$  is the fine structure constant,  $m$  is the rest mass of the electron, and  $\beta = v/c$ . MCNP now follows the recommendation of Seltzer,<sup>52</sup> and the implementation in the Integrated TIGER Series, by using the slightly modified form

$$\eta = \frac{1}{4} \left( \frac{\alpha mc}{0.885 p} \right)^2 Z^{2/3} \left[ 1.13 + 3.76(\alpha Z/\beta)^2 \sqrt{\frac{4}{\tau + 1}} \right],$$

where  $\tau$  is the electron energy in units of electron rest mass. The multiplicative factor in the final term is an empirical correction which improves the agreement at low energies between the factored cross section and the more accurate partial-wave cross sections of Riley.

### 6. Bremsstrahlung

In the el1 evaluation, for the sampling of bremsstrahlung photons, MCNP relies primarily on the Bethe-Heitler<sup>69</sup> Born-approximation results that have been used until rather recently<sup>57</sup> in ETRAN. A comprehensive review of bremsstrahlung formulas and approximations relevant to the present level of the theory in MCNP can be found in the paper of Koch and Motz.<sup>70</sup> Particular prescriptions appropriate to Monte Carlo calculations have been developed by Berger and Seltzer.<sup>71</sup> For the ETRAN-based codes, this body of data has been converted to tables including bremsstrahlung production probabilities, photon energy distributions, and photon angular distributions.

In the el03 evaluation, the production cross section for bremsstrahlung photons and energy spectra are from the evaluation by Seltzer and Berger.<sup>57,58,59</sup> We summarize the salient features of the evaluation below; more details can be found in the evaluators' documentation. The evaluation uses detailed calculations of the electron-nucleus bremsstrahlung cross section for electrons with energies below 2 MeV and above 50 MeV. The evaluation below 2 MeV uses the results of Pratt, Tseng, and collaborators, based on numerical phase-shift calculations.<sup>72,73,74</sup> For 50 MeV and above, the analytical theory of Davies, Bethe, Maximom, and Olsen<sup>75</sup> is used and is supplemented by the Elwert Coulomb<sup>76</sup> correction factor and the theory of the high-frequency limit or tip region given by Jabbur and Pratt.<sup>77</sup> Screening effects are accounted for by the use of Hartree-Fock atomic form factors.<sup>78</sup> The values between these firmly grounded theoretical limits

are found by a cubic-spline interpolation as described in Ref. 57 and Ref. 58. Seltzer reports good agreement between interpolated values and those calculated by Tseng and Pratt<sup>79</sup> for 5 and 10 MeV electrons in aluminum and uranium. Electron-electron bremsstrahlung is also included in the cross section evaluation based on the theory of Haug<sup>80</sup> with screening corrections derived from Hartree-Fock incoherent scattering factors.<sup>78</sup> The energy spectra for the bremsstrahlung photons are provided in the evaluation. No major changes were made to the tabular angular distributions, which are internally calculated when using the el1 evaluation, except to make finer energy bins over which the distribution is calculated.

MCNP addresses the sampling of bremsstrahlung photons at each electron substep. The tables of production probabilities are used to determine whether a bremsstrahlung photon will be created. In the el03 evaluation, the bremsstrahlung production is sampled according to a Poisson distribution along the step so that none, one or more photons could be produced; the el1 evaluation allows for either none or one bremsstrahlung photon in a substep. If a photon is produced, the new photon energy is sampled from the energy distribution tables. By default, the angular deflection of the photon from the direction of the electron is also sampled from the tabular data. The direction of the electron is unaffected by the generation of the photon, because the angular deflection of the electron is controlled by the multiple scattering theory. However, the energy of the electron at the end of the substep is reduced by the energy of the sampled photon, because the treatment of electron energy loss, with or without straggling, is based only on nonradiative processes.

There is an alternative to the use of tabular data for the angular distribution of bremsstrahlung photons. If the fourth entry on the PHYS:E card is 1, then the simple, material-independent probability distribution

$$p(\mu)d\mu = \frac{1 - \beta^2}{2(1 - \beta\mu)^2}d\mu \quad , \quad (2.12)$$

where  $\mu = \cos\theta$  and  $\beta = v/c$ , will be used to sample for the angle of the photon relative to the direction of the electron according to the formula

$$\mu = \frac{2\xi - 1 - \beta}{2\xi\beta - 1 - \beta} \quad ,$$

where  $\xi$  is a random number. This sampling method is of interest only in the context of detectors and DXTRAN spheres. A set of source contribution probabilities  $p(\mu)$  consistent with the tabular data is not available. Therefore, detector and DXTRAN source contributions are made using Eq. 2.12. Specifying that the generation of bremsstrahlung photons rely on Eq. 2.12 allows the user to force the actual transport to be consistent with the source contributions to detectors and DXTRAN.



## CHAPTER 2 PHYSICS

### 7. K-shell electron impact ionization and Auger transitions

The eI03 evaluation does not change the K-shell impact ionization calculation (based upon ITS1.0) except for how the emission of relaxation photons is treated; the eI03 evaluation model has been modified to be consistent with the photo-ionization relaxation model. In the eI1 evaluation, a K-shell impact ionization event generated a photon with the average K-shell energy. The eI03 evaluation generates photons with energies given by Everett and Cashwell.<sup>33</sup> Both eI03 and eI1 treatments only take into account the highest Z component of a material. Thus inclusion of trace high Z impurities could mask K-shell impact ionization from other dominant components.

Auger transitions are handled the same in the eI03 and eI1 evaluations. If an atom has undergone an ionizing transition and can undergo a relaxation, if it does not emit a photon it will emit an Auger electron. The difference between eI1 and eI03 is the energy with which an Auger electron is emitted, given by  $E_A = E_{\bar{K}}$  or  $E_A = E_{\bar{K}} - 2E_{\bar{L}}$  for eI1 or eI03, respectively. The eI1 value is that of the highest energy Auger electron while the eI03 value is the energy of the most probable Auger electron. It should be noted that both models are somewhat crude.

### 8. Knock-On Electrons

The Møller cross section<sup>81</sup> for scattering of an electron by an electron is

$$\frac{d\sigma}{d\varepsilon} = \frac{C}{E} \left\{ \frac{1}{\varepsilon^2} + \frac{1}{(1-\varepsilon)^2} + \left( \frac{\tau}{\tau+1} \right)^2 - \frac{2\tau+1}{(\tau+1)^2} \frac{1}{\varepsilon(1-\varepsilon)} \right\}, \quad (2.13)$$

where  $\varepsilon$ ,  $\tau$ ,  $E$ , and  $C$  have the same meanings as in Eqs. 2.5-2.7. When calculating stopping powers, one is interested in all possible energy transfers. However, for the sampling of transportable secondary particles, one wants the probability of energy transfers greater than some  $\varepsilon_c$  representing an energy cutoff, below which secondary particles will not be followed. This probability can be written

$$\sigma(\varepsilon_c) = \int_{\varepsilon_c}^{1/2} \frac{d\sigma}{d\varepsilon} d\varepsilon.$$

The reason for the upper limit of  $1/2$  is the same as in the discussion of Eq. 2.8. Explicit integration of Eq. 2.13 leads to

$$\sigma(\varepsilon_c) = \frac{C}{E} \left\{ \frac{1}{\varepsilon_c} - \frac{1}{1-\varepsilon_c} + \left( \frac{\tau}{\tau+1} \right)^2 \left( \frac{1}{2} - \varepsilon_c \right) - \frac{2\tau+1}{(\tau+1)^2} \ln \frac{1-\varepsilon_c}{\varepsilon_c} \right\}.$$

Then the normalized probability distribution for the generation of secondary electrons with  $\varepsilon > \varepsilon_c$  is given by

$$g(\varepsilon, \varepsilon_c)d\varepsilon = \frac{1}{\sigma(\varepsilon_c)} \frac{d\sigma}{d\varepsilon} d\varepsilon \quad . \quad (2.14)$$

At each electron substep, MCNP uses  $\sigma(\varepsilon_c)$  to determine randomly whether knock-on electrons will be generated. If so, the distribution of Eq. 2.14 is used to sample the energy of each secondary electron. Once an energy has been sampled, the angle between the primary direction and the direction of the newly generated secondary particle is determined by momentum conservation. This angular deflection is used for the subsequent transport of the secondary electron. However, neither the energy nor the direction of the primary electron is altered by the sampling of the secondary particle. On the average, both the energy loss and the angular deflection of the primary electron have been taken into account by the multiple scattering theories.

### 9. Multigroup Boltzmann–Fokker–Planck Electron Transport

The electron physics described above can be implemented into a multigroup form using a hybrid multigroup/continuous-energy method for solving the Boltzmann–Fokker–Planck equation as described by Morel.<sup>39</sup> The multigroup formalism for performing charged particle transport was pioneered by Morel and Lorence<sup>40</sup> for use in deterministic transport codes. With a first order treatment for the continuous slowing down approximation (CSDA) operator, this formalism is equally applicable to a standard Monte Carlo multigroup transport code as discussed by Sloan.<sup>82</sup> Unfortunately, a first order treatment is not adequate for many applications. Morel, et.al. have addressed this difficulty by developing a hybrid multigroup/continuousenergy algorithm for charged particles that retains the standard multigroup treatment for large-angle scattering, but treats exactly the CSDA operator. As with standard multigroup algorithms, adjoint calculations are performed readily with the hybrid scheme.

The process for performing an MCNP/MGBFP calculation for electron/photon transport problems involves executing three codes. First the CEPXS<sup>40</sup> code is used to generate coupled electron–photon multigroup cross sections. Next the CRSRD code casts these cross sections into a form suitable for use in MCNP by adjusting the discrete ordinate moments into a Radau quadrature form that can be used by a Monte Carlo code. CRSRD also generates a set of multigroup response functions for dose or charge deposition that can be used for response estimates for a forward calculation or for sources in an adjoint calculation. Finally, MCNP is executed using these adjusted multigroup cross sections. Some applications of this capability for electron/photon transport have been presented in Ref. 83.

## CHAPTER 2 TALLIES

### V. TALLIES

MCNP provides seven standard neutron tallies, six standard photon tallies, and four standard electron tallies. These basic tallies can be modified by the user in many ways. All tallies are normalized to be per starting particle except in KCODE criticality problems.

Tally Mnemonic				Description	
F1:N	or	F1:P	or	F1:E	Surface current
F2:N	or	F2:P	or	F2:E	Surface flux
F4:N	or	F4:P	or	F4:E	Track length estimate of cell flux
F5a:N	or	F5a:P			Flux at a point or ring detector
F6:N	or	F6:P	or	F6:N,P	Track length estimate of energy deposition
F7:N					Track length estimate of fission energy deposition
F8:N	or	F8:P	or	F8:E	Pulse height tally
			or	F8:P,E	

The above seven tally categories represent the basic MCNP tally types. To have many tallies of a given type, add multiples of 10 to the tally number. For example, F1, F11, F21...F981, F991 are all type F1 tallies. Particle type is specified by appending a colon and the particle designator. For example, F11:N and F96:N are neutron tallies and F2:P and F25:P are photon tallies. F6 tallies can be for both neutrons and photons – F16:N,P. F8 tallies are for both photons and electrons: F8:P, F8:E, and F8:P,E are all identical. F8:N is also allowed, though not advised, because MCNP neutron transport does not currently sample joint collision exit densities in an analog way.

Thought should be given to selecting a tally and to comparing one tally with another. For example, if the flux is varying as  $1/R^2$  in a cell, an average flux in the cell determined by the F4 tally will be higher than the flux at a point in the center of the cell determined by a detector. This same consideration applies to the average flux provided by DXTRAN spheres (see page 2–150).

Standard summary information that gives the user a better insight into the physics of the problem and the adequacy of the Monte Carlo simulation includes a complete accounting of the creation and loss of all tracks and their energy; the number of tracks entering and reentering a cell plus the track population in the cell; the number of collisions in a cell; the average weight, mean free path, and energy of tracks in a cell; the activity of each nuclide in a cell; and a complete weight balance for each cell.

The quantities actually scored in MCNP before the final normalization per starting particle are presented in Table 2.1. Note that adding an asterisk (\*Fn) changes the units and multiplies the tally as indicated in the last column of Table 2.1. For an F8 pulse height tally the asterisk changes the tally from deposition of pulses to an energy deposition tally. Table 2.1 also defines much of the notation used in the remainder of this section.

Extensive statistical analysis of tally convergence also is applied to one bin of each tally. Ten statistical checks are made, including the variance of the variance and the Pareto slope of the tally density function. These are described in detail starting on page 2-99.

**TABLE 2.1:**  
**Tally Quantities Scored**

Tally	Fn Quantity	Fn Units	*Fn Multiplier	*Fn Units
F1	W		E	MeV
F2	$W/( \mu  * A)$	1/cm <sup>2</sup>	E	MeV/cm <sup>2</sup>
F4	$W * T_l/V$	1/cm <sup>2</sup>	E	MeV/cm <sup>2</sup>
F5	$W * p(\mu) * exp(-\lambda)/(2\pi R^2)$	1/cm <sup>2</sup>	E	MeV/cm <sup>2</sup>
F6	$W * T_l * \sigma_T(E) * H(E) * \rho_a/m$	MeV/gm	1.60219E-22	jerks/gm
F7	$W * T_l * \sigma_f(E) * Q * \rho_a/m$	MeV/gm	1.60219E-22	jerks/gm
F8	$W_s$ put in bin $E * W/W_s$	pulses	E	MeV

- $W$  = particle weight
- $W_s$  = source weight
- $E$  = particle energy (MeV)
- $|\mu|$  = absolute value of cosine of angle between surface normal and particle trajectory.  
If  $|\mu| < .1$ , set  $|\mu| = .05$ .
- $A$  = surface area (cm<sup>2</sup>)
- $T_l$  = track length (cm) = transit time \* velocity
- $V$  = volume (cm<sup>3</sup>)
- $p(\mu)$  = probability density function:  $\mu$  = cosine of angle between particle trajectory and detector
- $\lambda$  = total mean free path to detector
- $R$  = distance to detector (cm)
- $\sigma_T(E)$  = microscopic total cross section (barns)
- $H(E)$  = heating number (MeV/collision)
- $\rho_a$  = atom density (atoms/barn-cm)
- $m$  = cell mass (gm)

## CHAPTER 2 TALLIES

$$\begin{aligned}\sigma_f(E) &= \text{microscopic fission cross section (barns)} \\ Q &= \text{fission heating Q-value (MeV)}\end{aligned}$$

The following MCNP definitions of current and flux come from reactor theory but are related to similar quantities in radiative transfer theory. The MCNP particle angular flux multiplied by the particle energy is the same as the intensity in radiative transfer theory. The MCNP particle total flux at energy  $E$  multiplied by the particle energy equals the integrated energy density times the speed of light in radiative transfer theory. The MCNP particle current multiplied by the particle energy is analogous to the radiative flux crossing an area in radiative transfer theory. The MCNP particle current uses  $|\mu|$  in the definition, whereas the radiative transfer flux uses  $\mu$  in its definition. MCNP current is neither net nor positive nor negative current; it is the number of particles crossing a surface in a particular direction. The MCNP particle fluence multiplied by the particle energy is the same as the fluence in radiative transfer theory.

### A. *Surface Current Tally*

The F1 surface current tally estimates the following quantity:

$$\begin{aligned}F1 &= \int_A \int_{\mu} \int_t \int_E J(\vec{r}, E, t, \mu) dE dt d\mu dA \\ *F1 &= \int_A \int_{\mu} \int_t \int_E E *J(\vec{r}, E, t, \mu) dE dt d\mu dA .\end{aligned}$$

This tally is the number of particles (quantity of energy for \*F1) crossing a surface. The scalar current is related to the flux as  $J(\vec{r}, E, t, \mu) = |\mu| \Phi(\vec{r}, E, t) A$ . The range of integration over area, energy, time, and angle ( $A, E, t, \mu$ ) can be controlled by FS, E, T, and C cards, respectively. The FT card can be used to change the vector relative to which  $\mu$  is calculated (FRV option) or to segregate electron current tallies by charge (ELC option).

### B. *Flux Tallies*

The F2, F4 and F5 flux tallies are estimates of

$$\begin{aligned}F_2 &= \int_A \int_t \int_E \Phi(\vec{r}, E, t) dt \frac{dA}{A} \\ *F_2 &= \int_A \int_t \int_E E * \Phi(\vec{r}, E, t) dE dt \frac{dA}{A}\end{aligned}$$

$$F_4 = \int_V \int_t \int_E \Phi(\vec{r}, E, t) dE dt \frac{dV}{V}$$

$$*F_4 = \int_V \int_t \int_E E * \Phi(\vec{r}, E, t) dE dt \frac{dV}{V}$$

$$F_5 = \int_t \int_E \Phi(\vec{r}, E, t) dE dt$$

$$*F_5 = \int_t \int_E E * \Phi(r, E, t) dE dt$$

The range of integration over energy and time is controlled by E and T cards. The F2 surface flux and F4 cell flux tallies are discussed below. The F5 detector flux tally, a major topic, is discussed on page 2–85.

The units of the flux tally are the units of the source. If the source has units of particles per unit time, the tally is also particles per unit time. When the source has units of particles, this tally represents a fluence tally. A steady-state flux solution can be obtained by having a source with units of particles per unit time and integrating over all time (that is, omitting the Tn card). The flux can be obtained from the fluence tally for a time-dependent source by dividing the tally by the time bin width. These tallies can all be made per unit energy by dividing by the energy bin width.

### 1. Track Length Estimate of Cell Flux (F4)

The definition of particle flux is  $\Phi(\vec{r}, E, t) = vN(\vec{r}, E, t)$ , where  $v$  = particle velocity and  $N$  = particle density = particle weight/unit volume. Roughly speaking, the time integrated flux is

$$\int_V \int_t \int_E \Phi(\vec{r}, E, t) dE dt \frac{dV}{V} = Wv t/V = WT_l/V \quad .$$

More precisely, let  $ds = vdt$ . Then the time-integrated flux is

$$\int_V \int_E \int_t \left( \Phi(\vec{r}, E, t) dt dE \frac{dV}{V} \right) = \int_v \int_E \int_s N(\vec{r}, E, t) ds dE \frac{dV}{V} \quad .$$

Because  $N(\vec{r}, E, t) ds$  is a track length density, MCNP estimates this integral by summing  $WT_l/V$  for all particle tracks in the cell, time range, and energy range. Because of the track length term  $T_l$  in the numerator, this tally is known as a track length estimate of the flux. It is generally quite reliable because there are frequently many tracks in a cell (compared to the number of collisions), leading to many contributions to this tally.

**CHAPTER 2  
TALLIES**

**2. Surface Flux (F2)**

The surface flux is a surface estimator but can be thought of as the limiting case of the cell flux or track length estimator when the cell becomes infinitely thin as illustrated in Fig. 2-6.

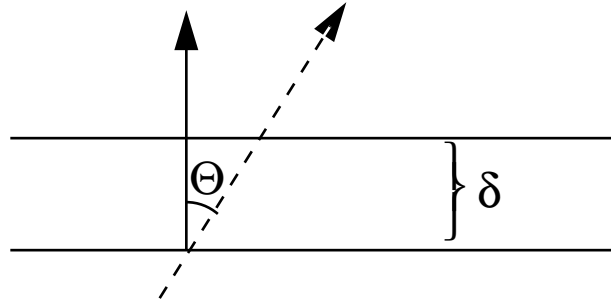

**Figure 2-6.**

$$F2 = \lim_{\delta \rightarrow 0} WT_l/V$$

$$= (W\delta/|\cos\theta|)/(A\delta) = W/(A|\mu|)$$

As the cell thickness  $\delta$  approaches zero, the volume approaches  $A\delta$  and the track length approaches  $\delta/|\mu|$ , where  $\mu = \cos\theta$ , the angle between the surface normal and the particle trajectory. This definition of flux also follows directly from the relation between flux and current,  $J(\vec{r}, E, t, \mu) = |\mu|\Phi(\vec{r}, E, t)A$ . MCNP sets  $|\mu| = .05$  when  $|\mu| < .1$ . The F2 tally is essential for stochastic calculation of surface areas when the normal analytic procedure fails.

**C. *Track Length Cell Energy Deposition Tallies***

The F6 and F7 cell heating and energy deposition tallies are the following track length estimates

$$F_{6,7} = \rho_a/\rho_g \int_V \int_t \int_E H(E)\Phi(\vec{r}, E, t)dE dt \frac{dV}{V} ,$$

where

- $\rho_a$  = atom density (atoms/barn-cm)
- $\rho_g$  = gram density (grams/cm<sup>3</sup>)
- $H(E)$  = heating response (summed over nuclides in a material)

The units of the heating tally are MeV/gm. An asterisk ( $*F_{6,7}$ ) changes the units to jerks/gm (1 MeV = 1.60219E-22 jerks). The asterisk causes the  $F_{6,7}$  tally to be modified by a constant rather

than by energy as in other tallies. Note that the heating tallies are merely flux tallies (F4) multiplied by an energy-dependent multiplier (FM card).

Energy deposition for photons and electrons can be computed with the \*F8 tally, which is a surface estimator rather than a track length estimator. See page 2–83 .

The F7 tally includes the gamma heating because the photons are deposited locally. The F6 tally deposits the photons elsewhere, so it does not include gamma heating. Thus for fissionable materials, the F7 result often will be greater than the F6 result even though F7 includes only fission and F6 includes all reactions. The true heating is found by summing the neutron and photon F6 tallies in a coupled neutron/photon calculation. In a neutron-only problem, F6 will give the right heating of light materials only if all photons escape the geometry. F7 will give about the right heating of fissionable materials only if no photons come from elsewhere, all fission photons are immediately captured, and nonfission reactions can be ignored. The F7 tally cannot be used for photons. Examples of combining the neutron and photon F6 tallies are F6:N,P and F516:P,N

The heating response  $H(E)$  has different meanings, depending upon context as follows:

1. F6 Neutrons

$H(E) = \sigma_T(E) H_{avg}(E)$ , where the heating number is

$$H_{avg}(E) = E - \sum_i p_i(E) [\bar{E}_{out_i}(E) - Q_i + \bar{E}_{\gamma_i}(E)] \quad ,$$

and

- $\sigma_T$  = total neutron cross section,
- $E$  = incident neutron energy,
- $p_i(E)$  = probability of reaction  $i$ ,
- $E_{out_i}$  = average exiting neutron energy for reaction  $i$ ,
- $Q_i$  = Q-value of reaction  $i$ ,
- $\bar{E}_{\gamma_i}$  = average energy of exiting gammas for reaction  $i$ .

2. F6 Photons

$H(E) = \sigma_T(E) H_{avg}(E)$ , where the heating number is

$$H_{avg}(E) = \sum_{i=1}^3 p_i(E) * (E - \bar{E}_{out})$$



## CHAPTER 2 TALLIES

$i = 1$  incoherent (Compton) scattering with form factors

$i = 2$  pair production  $\bar{E}_{out} = 1.022016 = 2m_0c^2$

$i = 3$  photoelectric.

All energy transferred to electrons is assumed to be deposited locally.

### 3. F7 Neutrons

$$H(E) = \sigma_f(E)Q \quad ,$$

where

$\sigma_f(E)$  = total fission cross section and  
 $Q$  = fission Q-value (MeV).

The Q-values as tabulated represent the total prompt energy release per fission and are printed in optional PRINT TABLE 98. The total fission cross section is (n,f) + (n,nf) + ... .

### 4. F7 Photons

$H(E)$  is undefined because photofission is not included in MCNP.

### 5. Equivalence of F4, F6, and F7 Tallies

The F6 and F7 heating tallies are special cases of the F4 track length estimate of cell flux with energy-dependent multipliers. The following F4 and FM4 combinations give exactly the same results as the F6 and F7 tallies. In this example, material 9 in cell 1 is  $^{235}\text{U}$  with an atom density ( $\rho_a$ ) of .02 atoms/barn-cm and a gram density ( $\rho_g$ ) of 7.80612 g/cm<sup>3</sup> for an atom/gram ratio of .0025621.

F4:N 1  
 FM4 .0025621 9 1 4 gives the same result as F6:N 1

F14:N 1  
 FM14 .0025621 9 -6 8 gives the same result as F17:N 1

F24:P 1  
 FM24 .0025621 9 5 6 gives the same result as F26:P 1

For the photon results to be identical, both electron transport and the thick target bremsstrahlung approximation must be turned off by PHYS:P j 1. In the F6 tally, if a photon produces an electron that produces a photon, the second photon is not counted again. It is already tallied in the first photon heating. In the F4 tally, the second photon track is counted, so the F4 tally will slightly overpredict the tally.

The photon heating tally also can be checked against the \*F8 energy deposition tally (divided by cell mass to give answers in MeV per gram). Results will not be identical because the tallies are totally independent and use different estimators.

The FM card can be used to make the surface flux tally (F2) and point and ring detector tallies (F5) calculate heating as well.

#### ***D. Pulse Height Tallies***

The pulse height tally provides the energy distribution of pulses created in a cell that models a physical detector. It also can provide the energy deposition in a cell. Although the entries on the F8 card are cells, this is not a track length cell tally. F8 tallies are made at source points and at surface crossings.

The pulse height tally is analogous to a physical detector. The F8 energy bins correspond to the total energy deposited in a detector in the specified channels by each physical particle. All the other MCNP tallies record the energy of a scoring track in the energy bin.

In an experimental configuration, suppose a source emits 100 photons at 10 MeV, and ten of these get to the detector cell. Further, suppose that the first photon (and any of its progeny created in the cell) deposits 1 keV in the detector before escaping, the second deposits 2 keV, and so on up to the tenth photon which deposits 10 keV. Then the pulse height measurement at the detector would be one pulse in the 1 keV energy bin, 1 pulse in the 2 keV energy bin, and so on up to 1 pulse in the 10 keV bin.

In the analogous MCNP pulse height tally, the source cell is credited with the energy times the weight of the source particle. When a particle crosses a surface, the energy times the weight of the particle is subtracted from the account of the cell that it is leaving and is added to the account of the cell that it is entering. The energy is the kinetic energy of the particle plus  $2m_0c^2 = 1.022016$  if the particle is a positron. At the end of the history, the account in each tally cell is divided by the source weight. The resulting energy determines which energy bin the score is put in. The value of the score is the source weight for an F8 tally and the source weight times the energy in the account for a \*F8 tally. The value of the score is zero if no track entered the cell during the history.

The pulse height tally is an inherently analog process. Therefore, it does not work well with neutrons, which are inherently non analog, and it does not work at all with most variance reduction schemes. The pulse height tally depends on sampling the joint density of all particles exiting a collision event. MCNP does not currently sample this joint density for neutron collisions. Thus neutron F8 tallies must be done with extreme caution when more than one neutron can exit a collision. Suppose in the above example, the photon that deposited 10 keV in the detector cell underwent a 2-for-1 split. Then if only one of the split halves entered the cell,

## CHAPTER 2 TALLIES

the tally would be incorrectly put in the 5 keV bin rather than the 10 keV bin. Or if the particle survived a Russian roulette event, its weight would be double and the score would be put into the 20 keV bin. Similar scenarios can be given for other variance reduction methods. The MCNP pulse height tally will not work with any variance reduction other than source biasing. It doesn't work well with neutrons even without variance reduction because the MCNP neutron physics is nonanalog (in the joint density sampling), particularly in the way that multiple neutrons exiting a collision are totally uncorrelated and don't even conserve energy except in an average sense over many neutron histories.

Another aspect of the pulse height tally that is different from other MCNP tallies is that F8:P, F8:E and F8:P,E are all equivalent. All the energy from both photons and electrons, if present, will be deposited in the cell, no matter which tally is specified.

When the pulse height tally is used with energy bins, care must be taken because of negative scores from nonanalog processes and zero scores caused by particles passing through the pulse height cell without depositing energy. In some codes, like the Integrated Tiger Series, these events cause large contributions to the lowest energy bin pulse height score. In other codes no contribution is made. MCNP compromises by counting these events in a zero bin and an epsilon bin so that these scores can be segregated out. It is recommended that your energy binning for an F8 tally be something like

E8 0 1 E -5 E1 E2 E3 E4 E5 ...

Knock-on electrons in MCNP are nonanalog in that the energy loss is included in the multiple scattering energy loss rate rather than subtracted out at each knock-on event. Thus knock-ons can cause negative energy pulse height scores. These scores will be caught in the 0 energy bin. If they are a large fraction of the total F8 tally, then the tally is invalid because of nonanalog events. Another situation is differentiating zero contributions from particles not entering the cell and particles entering the cell but not depositing any energy. These are differentiated in MCNP by causing an arbitrary 1.E-12 energy loss for particles just passing through the cell. These will appear in the 0-epsilon bin.

When the \*F8 energy deposition tally is used and no energy bins are specified, variance reduction of all kinds is allowed. The analog requirement to put a score in the proper energy bin is removed in this special case of \*F8 with no energy binning. If the tally had energy bins, the total energy deposition is correct even though the tallies in the energy bins are wrong. When Russian roulette is played at a surface bounding a pulse height tally, the variance can become large because the roulette is played after the energy-times-weight entering the cell is recorded. Particles terminated by roulette deposit all their energy in the cell. Particles surviving the roulette have increased weight that can now record more energy-times-weight leaving the cell than entered. On average, the total energy deposition is correct, but the negative and positive scores cause an unbounded variance. Therefore, do not play roulette at pulse height cell boundaries.

*E. Flux at a Detector*

Flux can be estimated at a point with either point or ring detector next-event estimators. Detectors can yield anomalous statistics and must be used with caution. Detectors also have special variance reduction features, such as a highly advantageous DD card Russian roulette game. Whenever a user-supplied source is specified, a user-supplied source angle probability density function must be provided also.

1. Point Detector

A point detector is a deterministic estimate (from the current event point) of the flux at a point in space. Contributions to the point detector tally are made at source and collision events throughout the random walk. Suppose  $p(\mu, \varphi)d\Omega$  is the probability of the particle's scattering or being born into the solid angle  $d\Omega$  about the direction  $(\mu, \varphi)$ , where  $\varphi$  is the azimuthal angle and  $\mu$  is the cosine of the angle between the incident particle direction and the direction from the collision point to the detector. If  $R$  is the distance to the detector from the collision or source point, then

$$p(\mu, \varphi)d\Omega \cdot e^{-\int_0^R \Sigma_t(s)ds}$$

yields the probability of scattering into  $d\Omega$  about  $(\mu, \varphi)$  and arriving at the detector point with no further collisions. The attenuation of a beam of monoenergetic particles passing through a material medium is given by  $\exp[-\int_0^R \Sigma_t(s)ds]$  where  $s$  is measured along the direction from the collision or source point to the detector and  $\Sigma_t(s)$  is the macroscopic total cross section at  $s$ . If  $dA$  is an element of area normal to the scattered line of flight to the detector,  $d\Omega = dA/R^2$  and therefore

$$p(\mu, \varphi) \frac{dA}{R^2} e^{-\int_0^R \Sigma_t(s)ds}$$

is the expression giving the probability of scattering toward the detector and passing through the element of area  $dA$  normal to the line of flight to the detector. Because the flux is by definition the number of particles passing through a unit area normal to the scattered direction, the general expression for the contribution to the flux is given by

$$\frac{p(\mu, \varphi)}{R^2} e^{-\int_0^R \Sigma_t(s)ds} .$$

In all the MCNP scattering distributions and in the standard sources, we assume azimuthal symmetry. Therefore,

## CHAPTER 2 TALLIES

$$p(\mu) = \int_0^{2\pi} p(\mu, \varphi) d\varphi$$

and  $\varphi$  is sampled uniformly on  $(0, 2\pi)$ . That is,  $p(\mu, \varphi) = p(\mu)/2\pi$ .

If  $p(\mu, \varphi) = p(\mu)/2\pi$  is substituted in the expression for the flux, the expression used in MCNP is arrived at:

$$\Phi(\vec{r}, E, t, \mu) = Wp(\mu)e^{-\lambda}/(2\pi R^2) \quad ,$$

when

- $W$  = particle weight;
- $\lambda = \int_0^R \Sigma_t(s) ds$  = total number of mean free paths integrated over the trajectory from the source or collision point to the detector;
- $R$  = distance from source or collision event to detector; and
- $p(\mu)$  = value of probability density function at  $\mu$ , the cosine of the angle between the particle trajectory and the direction to the detector.

A point detector is known as a “next-event estimator” because it is a tally of the flux at a point if the next event is a trajectory without further collision directly to the point detector.

A contribution to the point detector is made at every source or collision event. The  $e^{-\lambda}$  term accounts for attenuation between the present event and the detector point. The  $1/2\pi R^2$  term accounts for the solid angle effect. The  $p(\mu)$  term accounts for the probability of scattering toward the detector instead of the direction selected in the random walk. For an isotropic source or scatter,  $p(\mu) = 0.5$  and the solid angle terms reduce to the expected  $1/4\pi R^2$ . (Note that  $p(\mu)$  can be larger than unity, because it is the value of a density function and not a probability.) Each contribution to the detector can be thought of as the transport of a pseudoparticle to the detector.

The  $R^2$  term in the denominator of the point detector causes a singularity that makes the theoretical variance of this estimator infinite. That is, if a source or collision event occurs near the detector point,  $R$  approaches zero and the flux approaches infinity. The technique is still valid and unbiased, but convergence is slower and often impractical. If the detector is not in a source or scattering medium, a source or collision close to the detector is impossible. For problems where there are many scattering events near the detector, a cell or surface estimator should be used instead of a point detector tally. If there are so few scattering events near the detector that cell and surface tallies are impossible, a point detector can still be used with a specified average flux region close to the detector. This region is defined by a fictitious sphere of radius  $R_o$  surrounding the point detector.  $R_o$  can be specified either in centimeters or in mean free paths. If  $R_o$  is specified in centimeters and if  $R < R_o$ , the point detector estimation inside  $R_o$  is assumed to be the average flux uniformly distributed in volume.

$$\begin{aligned}\Phi(R < R_o) &= \frac{\int \Phi dV}{\int dV} \\ &= Wp(\mu) \frac{\int_0^{R_o} e^{(-\Sigma_t r)} 4\pi r^2 dr}{\frac{4}{3}\pi R_o^3} \\ &= \frac{Wp(\mu)(1 - e^{-\Sigma_t R_o})}{\frac{2}{3}\pi R_o^3 \Sigma_t} .\end{aligned}$$

If  $\Sigma_t = 0$ , the detector is not in a scattering medium, no collision can occur, and

$$\Phi(R < R_o, \Sigma_t = 0) = \frac{Wp(\mu)R_o}{\frac{2}{3}\pi R_o^3} .$$

If the fictitious sphere radius is specified in mean free paths  $\lambda_0$ , then  $\lambda_0 = \Sigma_t R_o$  and

$$\Phi(\lambda < \lambda_0) = \frac{Wp(\mu)(1 - e^{-\lambda_0})\Sigma_t^2}{\frac{2}{3}\pi \lambda_0^3} .$$

The choice of  $R_o$  may require some experimentation. For a detector in a void region or a region with very few collisions (such as air),  $R_o$  can be set to zero. For a typical problem, setting  $R_o$  to a mean free path or some fraction thereof is usually adequate. If  $R_o$  is in centimeters, it should correspond to the mean free path for some average energy in the sphere. Be certain when defining  $R_o$  that the sphere it defines does not encompass more than one material unless you understand the consequences. This is especially true when defining  $R_o$  in terms of mean free path because  $R_o$  becomes a function of energy and can vary widely. In particular, if  $R_o$  is defined in terms of mean free paths and if a detector is on a surface that bounds a void on one side and a material on the other, the contribution to the detector from the direction of the void will be zero even though the importance of the void is nonzero. The reason is simply that the volume of the artificial sphere is infinite in a void. Contributions to the detector from the other direction (that is, across the material) will be accounted for.

Detectors differing only in  $R_o$  are coincident detectors (see page 2-94), and there is little cost incurred by experimenting with several detectors that differ only by  $R_o$  in a single problem.

## CHAPTER 2 TALLIES

### 2. Ring Detector

A ring detector<sup>84</sup> tally is a point detector tally in which the point detector location is not fixed but rather sampled from some location on a ring. Most of the previous section on point detectors applies to ring detectors as well. In MCNP three ring detector tallies FX, FY, and FZ correspond to rings located rotationally symmetric about the  $x$ ,  $y$ , and  $z$  coordinate axes. A ring detector usually enhances the efficiency of point detectors for problems that are rotationally symmetric about a coordinate axis. Ring detectors also can be used for problems where the user is interested in the average flux at a point on a ring about a coordinate axis.

Although the ring detector is based on the point detector that has a  $1/R^2$  singularity and an unbounded variance, the ring detector has a finite variance and only a  $1/R_{min}$  singularity, where  $R_{min}$  is the minimum distance between the contributing point and the detector ring.<sup>85</sup>

In a cylindrically symmetric system, the flux is constant on a ring about the axis of symmetry. Hence, one can sample uniformly for positions on the ring to determine the flux at any point on the ring. The ring detector efficiency is improved by biasing the selection of point detector locations to favor those near the contributing collision or source point. This bias results in the same total number of detector contributions, but the large contributions are sampled more frequently, reducing the relative error.

For isotropic scattering in the lab system, experience has shown that a good biasing function is proportional to  $e^{-P}R^{-2}$ , where  $P$  is the number of mean free paths and  $R$  is the distance from the collision point to the detector point. For most practical applications, using a biasing function involving  $P$  presents prohibitive computational complexity except for homogeneous medium problems. For air transport problems, a biasing function resembling  $e^{-P}$  has been used with good results. A biasing function was desired that would be applicable to problems involving dissimilar scattering media and would be effective in reducing variance. The function  $R^{-2}$  meets these requirements.

In Fig. 2-7, consider a collision point,  $(x_o, y_o, z_o)$  at a distance  $R$  from a point detector location  $(x, y, z)$ . The point  $(x, y, z)$  is to be selected from points on a ring of radius  $r$  that is symmetric about the  $y$ -axis in this case.

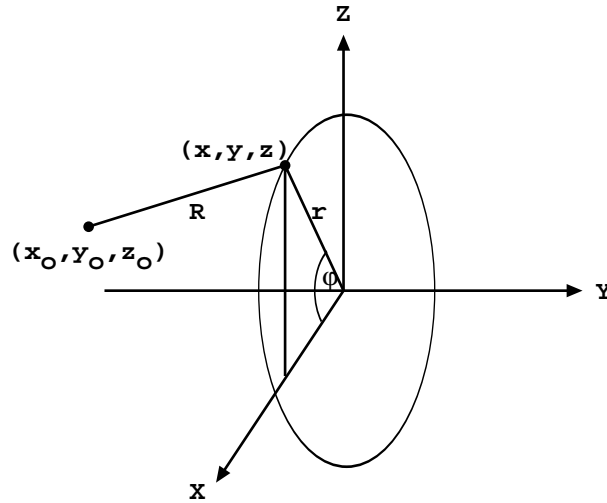

Figure 2-7.

To sample a position  $(x, y, z)$  on the ring with a  $1/R^2$  bias, we pick  $\phi$  from the density function  $p(\phi) = C/(2\pi R^2)$ , where  $C$  is a normalization constant. To pick  $\phi$  from  $p(\phi)$ , let  $\xi$  be a random number on the unit interval. Then

$$\begin{aligned} \xi &= \frac{C}{2\pi} \int_{-\pi}^{\phi} \frac{d\phi'}{R^2} \\ &= \frac{C}{2\pi} \int_{-\pi}^{\phi} \frac{d\phi'}{(x_o - r \cos \phi')^2 + (y_o - y)^2 + (z_o - r \sin \phi')^2} \\ &= \frac{C}{2\pi} \int_{-\pi}^{\phi} \frac{d\phi'}{a + b \cos \phi' + c \sin \phi'} \\ &= \frac{1}{\pi} \tan^{-1} \left\{ \frac{1}{C} \left[ (a - b) \tan \frac{\phi}{2} + c \right] \right\} + \frac{1}{2} \quad , \end{aligned}$$

where

$$\begin{aligned} a &= r^2 + x_o^2 + (y - y_o)^2 + z_o^2 \\ b &= -2rx_o \\ c &= -2rz_o \\ C &= (a^2 - b^2 - c^2)^{1/2}. \end{aligned}$$



## CHAPTER 2 TALLIES

The above expression is valid if  $a^2 > b^2 + c^2$ , which is true except for collisions exactly on the ring.

Solving for  $\tan \frac{\phi}{2}$ ,

$$\tan \frac{\phi}{2} = \frac{1}{a-b} \left\{ C \tan \left[ \pi \left( \xi - \frac{1}{2} \right) \right] - c \right\} .$$

Letting  $t = \tan \phi/2$ ,

$$\begin{aligned} \text{then } x &= r \cos \phi = r(1-t^2)/(1+t^2) \\ y &= y \text{ (fixed)} \\ z &= r \sin \phi = 2rt/(1+t^2). \end{aligned}$$

For ring detectors, the  $1/R^2$  biasing has been supplemented when it is weak to include a biasing based on angle to select the point on the ring. This angle is in the plane of the ring and is relative to the shortest line from the collision point to the detector ring. The angle that would most likely be selected would pick the same point on the ring as a straight line through the axis of the problem, the collision point, and the ring. The angle least likely to be picked would choose the point on the opposite side of the ring. This approach will thus make scores with smaller attenuations more often. This supplemental biasing is achieved by requiring that

$$a \leq 3/2(b^2 + c^2)^{1/2} \text{ in the above equation.}$$

If the radius of the ring is very large compared to the dimensions of the scattering media (such that the detector sees essentially a point source in a vacuum), the ring detector is still more efficient than a point detector. The reason for this unexpected behavior is that the individual scores to the ring detector for a specific history have a mean closer to the true mean than to the regular point detector contributions. That is, the point detector contributions from one history will tend to cluster about the wrong mean because the history will not have collisions uniformly in volume throughout the problem, whereas the ring detector will sample many paths through the problem geometry to get to different points on the ring.

### 3. General Considerations of Point Detector Estimators

a. Pseudoparticles and detector reliability: Point and ring detectors are Monte Carlo methods wherein the simulation of particle transport from one place to another is deterministically short-circuited. Transport from the source or collision point to the detector is replaced by a deterministic estimate of the potential contribution to the detector. This transport between the source or collision point and the detector can be thought of as being via

“pseudoparticles.” Pseudoparticles undergo no further collisions. These particles do not reduce the weight or otherwise affect the random walk of the particles that produced them. They are merely estimates of a potential contribution. The only resemblance to Monte Carlo particles is that the quantity they estimate requires an attenuation term that must be summed over the trajectory from the source or collision to the detector. Thus most of the machinery for transporting particles can also be used for the pseudoparticles. No records (for example, tracks entering) are kept about pseudoparticle passage.

Because detectors rely on pseudoparticles rather than particle simulation by random walk, they should be considered only as a very useful last resort. Detectors are unbiased estimators, but their use can be tricky, misleading, and occasionally unreliable. Consider the problem illustrated in Fig. 2-8.

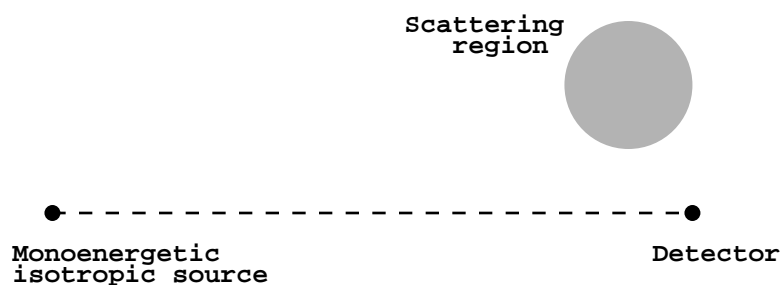

Figure 2-8.

The monoenergetic isotropic point source always will make the same contribution to the point detector, so the variance of that contribution will be zero. If no particles have yet collided in the scattering region, the detector tally will be converged to the source contribution, which is wrong and misleading. But as soon as a particle collides in the scattering region, the detector tally and its variance will jump. Then the detector tally and variance will steadily decrease until the next particle collides in the scattering region, at which time there will be another jump.

These jumps in the detector score and variance are characteristic of undersampling important regions. Next event estimators are prone to undersampling as already described on page 2-62 for the  $p(\mu)$  term of photon coherent scattering. The jump discussed here is from the sudden change in the  $R$  and possibly  $\lambda$  terms. Jumps in the tally caused by undersampling can be eliminated only by better sampling of the undersampled scattering region that caused them.

Biasing Monte Carlo particles toward the tally region would cause the scattering region to be sampled better, thus eliminating the jump problem. It is recommended that detectors be used with caution and with a complete understanding of the nature of next event estimators. When detectors are used, the tally fluctuation charts printed in the output file should be examined closely to see the degree of the fluctuations. Also the detector diagnostic print tables should be examined to see if any one pseudoparticle trajectory made an unusually large contribution to the

## CHAPTER 2 TALLIES

tally. Detector results should be viewed suspiciously if the relative error is greater than 5%. Close attention should be paid to the tally statistical analysis and the ten statistical checks described on page 2-121.

b. Detectors and reflecting, white or periodic surfaces: Detectors used with reflecting, white, or periodic surfaces give wrong answers because pseudoparticles travel only in straight lines. Consider Fig. 2-9, with a point detector and eight source cells. The imaginary cells and point detector are also shown on the other side of the mirror. The solid line shows the source contribution from the indicated cell. MCNP does not allow for the dashed-line contribution on the other side of the reflecting surface. The result is that contributions to the detector will always be from the solid path instead of from a mixture of solid and dashed contributions. This same situation occurs at every collision. Therefore, the detector tally will be lower (with the same starting weight) than the correct answer and should not be used with reflecting, white, or periodic surfaces. The effect is even worse for problems with multiple reflecting, white or periodic surfaces.

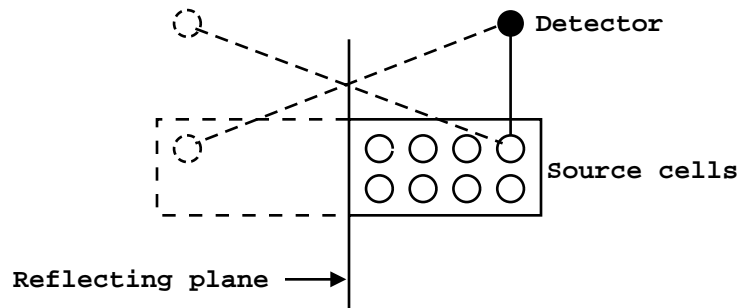

Figure 2-9.

c. Variance reduction schemes for detectors: Pseudoparticles of point detectors are not subject to the variance reduction schemes applied to particles of the random walk. They do not split according to importances, weight windows, etc., although they are terminated by entering zero importance cells. However, two Russian roulette games are available specifically for detector pseudoparticles.

The PD card can be used to specify the pseudoparticle generation probability for each cell. The entry for each cell  $i$  is  $p_i$  where  $0 \leq p_i \leq 1$ . Pseudoparticles are created with probability  $p_i$  and weight  $1/p_i$ . If  $p_i = 1$ , which is the default, every source or collision event produces a pseudoparticle. If  $p_i = 0$ , no pseudoparticle is produced. Setting  $p_i = 0$  in a cell that can actually contribute to a detector erroneously biases the detector tally by eliminating such contributions. Thus  $p_i = 0$  should be used only if the true probability of scoring is zero or if the score from cell  $i$  is unwanted for some legitimate reason such as problem diagnostics. Fractional entries of  $p_i$  should be used with caution because the PD card applies equally to all pseudoparticles. The DD card can be used to Russian roulette just the unimportant pseudoparticles. However, the DD card

roulette game often requires particles to travel some distance along their trajectory before being killed. When cells are many mean free paths from the detector, the PD card may be preferable.

The DD card controls both the detector diagnostic printing and a Russian roulette game played on pseudoparticles in transit to detectors. The Russian roulette game is governed by the input parameter  $k$  that controls a comparison weight  $w_c$  internal to MCNP, such that

$$\begin{aligned} w_c &= -k \text{ if } k < 0; \\ w_c &= 0 \text{ if } k = 0; \\ w_c &= 0 \text{ if } k > 0 \text{ and } N \leq 200; \\ w_c &= (k/N)\sum_i^I \phi_i \text{ if } k > 0 \text{ and } N > 200, \end{aligned}$$

where  $N$ =number of histories run so far,  
 $I$ =number of pseudoparticles started so far,  
 $\phi_i = Wp(\mu)e^{-\lambda}/(2\pi R^2)$ ,  
 $I$ =contribution of the  $i^{\text{th}}$  pseudoparticle to the detector tally.

When each pseudoparticle is generated,  $W$ ,  $p(\mu)$ , and  $R$  are already known before the expensive tracking process is undertaken to determine  $\lambda$ . If  $Wp(\mu)/(2\pi R^2) < w_c$ , the pseudoparticle contribution to the detector  $\phi_i$  will be less than the comparison weight. Playing Russian roulette on all pseudoparticles with  $\phi_i < w_c$  avoids the expensive tracking of unimportant pseudoparticles. Most are never started. Some are started but are rouletted as soon as  $\lambda$  has increased to the point where  $Wp(\mu)e^{-\lambda}/(2\pi R^2) < w_c$ . Rouletting pseudoparticles whose expected detector contribution is small also has the added benefit that those pseudoparticles surviving Russian roulette now have larger weights, so the disparity in particle weights reaching the detector is reduced. Typically, using the DD card will increase the efficiency of detector problems by a factor of ten. This Russian roulette is so powerful that it is one of two MCNP variance reduction options that is turned on by default. The default value of  $k$  is 0.1. The other default variance reduction option is implicit capture.

The DD card Russian roulette game is almost foolproof. Performance is relatively insensitive to the input value of  $k$ . For most applications the default value of  $k = 0.1$  is adequate. Usually, choose  $k$  so that there are 1–5 transmissions (pseudoparticle contributions) per source history. If  $k$  is too large, too few pseudoparticles are sampled; thus  $k \geq 1$  is a fatal error.

Because a random number is used for the Russian roulette game invoked by  $k > 0$ , the addition of a detector tally affects the random walk tracking processes. Detectors are the only tallies that affect results. If any other tally type is added to a problem, the original problem tallies remain unchanged. Because detectors use the default DD card Russian roulette game, and that game affects the random number sequence, the whole problem will track differently and the original tallies will agree only to within statistics. Because of this tracking difference, it is recommended

## CHAPTER 2 TALLIES

that  $k < 0$  be used once a good guess at  $w_c$  can be made. This is especially important if a problem needs to be debugged by starting at some history past the first one. Also,  $k < 0$  makes the first 200 histories run faster.

There are two cases when it is beneficial to turn off the DD card Russian roulette game by setting  $k = 0$ . First, when looking at the tail of a spectrum or some other low probability event, the DD card roulette game will preferentially eliminate small scores and thus eliminate the very phenomenon of interest. For example, if energy bias is used to preferentially produce high energy particles, these biased particles will have a lower weight and thus preferentially will be rouletted by the DD card game. Second, in very deep penetration problems, pseudoparticles will sometimes go a long way before being rouletted. In this rare case it is wasteful to roulette a pseudoparticle after a great deal of time has been spent following it and perhaps a fractional PD card should be used or, if possible, a cell or surface tally.

d. Coincident detectors: Because tracking pseudoparticles is very expensive, MCNP uses a single pseudoparticle for multiple detectors, known as coincident detectors, that must be identical in:

- geometric location,
- particle type (that is, neutron or photon),
- upper time bin limit,
- DD card Russian Roulette control parameter,  $k$ , and
- PD card entries, if any.

Energy bins, time bins, tally multipliers, response functions, fictitious sphere radii, user-supplied modifications (TALLYX), etc., can all be different. Coincident detectors require little additional computational effort because most detector time is spent in tracking a pseudoparticle. Multiple detectors using the same pseudoparticle are almost “free.”

e. Direct vs. total contribution: Unless specifically turned off by the user, MCNP automatically prints out both the direct and total detector contribution. Recall that pseudoparticles are generated at source and collision events. The direct contribution is that portion of the tally from pseudoparticles born at source events. The total contribution is the total tally from both source and collision events. For Mode N P problems with photon detectors, the direct contribution is from pseudophotons born in neutron collisions. The direct contributions for detailed photon physics will be smaller than the simple physics direct results because coherent scattering is included in the detailed physics total cross section and omitted in the simple physics treatment.

f. Angular distribution functions for point detectors: All detector estimates require knowledge of the  $p(\mu)$  term, the value of the probability density function at an angle  $\theta$ , where  $\mu = \cos \theta$ . This quantity is available to MCNP for the standard source and for all kinds of collisions. For user-supplied source subroutines, MCNP assumes an isotropic distribution

$$p(\mu)d\mu = \frac{d\Omega}{4\pi} = \int_0^{2\pi} \frac{d\mu d\phi}{4\pi} = \frac{1}{2}d\mu \quad .$$

Therefore, the variable  $PSC=p(\mu) = 1/2$ . If the source distribution is not isotropic in a user-supplied source subroutine, the user must also supply a subroutine SRCDX if there are any detectors or DXTRAN spheres in the problem. In subroutine SRCDX, the variable PSC must be set for each detector and DXTRAN sphere. An example of how this is done and also a description of several other source angular distribution functions is in Chapter 4.

g. Detectors and the  $S(\alpha,\beta)$  thermal treatment: The  $S(\alpha,\beta)$  thermal treatment poses special challenges to next event estimators because the probability density function for angle has discrete lines to model Bragg scattering and other molecular effects. Therefore, MCNP has an approximate model<sup>42</sup> that, for the PSC calculation (not the transport calculation), replaces the discrete lines with finite histograms of width  $\mu < .1$

This approximation has been demonstrated to accurately model the discrete line  $S(\alpha,\beta)$  data. In cases where continuous data is approximated with discrete lines, the approximate scheme cancels the errors and models the scattering better than the random walk.<sup>43</sup> Thus the  $S(\alpha,\beta)$  thermal treatment can be used with confidence with next event estimators like detectors and DXTRAN.

## ***F. Additional Tally Features***

The standard MCNP tally types can be controlled, modified, and beautified by other tally cards. These cards are described in detail in Chapter 3; an overview is given here.

### 1. Bin limit control

The integration limits of the various tally types are controlled by E, T, C, and FS cards. The E card establishes energy bin ranges; the T card establishes time bin ranges; the C card establishes cosine bin ranges; and the FS card segments the surface or cell of a tally into subsurface or subcell bins.

### 2. Flagging

Cell and surface flagging cards, CF and SF, determine what portion of a tally comes from where.

Example: F4      1  
          CF4     2 3 4

The flux tally for cell 1 is output twice: first, the total flux in cell 1; and second, the flagged tally, or that portion of the flux caused by particles having passed through cells 2, 3, or 4.

## CHAPTER 2 TALLIES

### 3. Multipliers and modification

MCNP tallies can be modified in many different ways. The EM, TM, and CM cards multiply the quantities in each energy, time, or cosine bin by a different constant. This capability is useful for modeling response functions or changing units. For example, a surface current tally can have its units changed to per steradian by entering the inverse steradian bin sizes on the CM card.

The DE and DF cards allow modeling of an energy-dependent dose function that is a continuous function of energy from a table whose data points need not coincide with the tally energy bin structure (E card). An example of such a dose function is the flux-to-radiation dose conversion factor given in Appendix H.

The FM card multiplies the F1, F2, F4, and F5 tallies by any continuous-energy quantity available in the data libraries. For example, average heating numbers  $H_{avg}(E)$  and total cross section  $\sigma_T(E)$  are stored on the MCNP data libraries. An F4 tally multiplied by  $\sigma_T H_{avg}(E) \rho_a / \rho_g$  converts it to an F6 tally, or an F5 detector tally multiplied by the same quantity calculates heating at a point (see page 2–82). The FM card can modify any flux or current tally of the form  $\int \phi(E) dE$  into  $\int R(E) \phi(E) dE$ , where  $R(E)$  is any combination of sums and products of energy-dependent quantities known to MCNP.

The FM card can also model attenuation. Here the tally is converted to  $\int \phi(E) e^{-\sigma_t(E) \rho_a x} dE$ , where  $x$  is the thickness of the attenuator,  $\rho_a$  is its atom density, and  $\sigma_t$  is its total cross section. Double parentheses allow the calculation of  $\int \phi(E) e^{-\sigma_t(E) \rho_a x} R(E) dE$ . More complex expressions of  $\sigma_t(E) \rho_a x$  are allowed so that many attenuators may be stacked. This is useful for calculating attenuation in line-of-sight pipes and through thin foils and detector coatings, particularly when done in conjunction with point and ring detector tallies. Beware, however, that attenuation assumes that the attenuated portion of the tally is lost from the system by capture or escape and cannot be scattered back in.

Two special FM card options are available. The first option sets  $R(E) = 1/\phi(E)$  to score tracks or collisions. The second option sets  $R(E) = 1/velocity$  to score population or prompt removal lifetime.

### 4. Special Treatments

A number of special tally treatments are available using the FT tally card. A brief description of each one follows.

a. Change current tally reference vector: F1 current tallies measure bin angles relative to the surface normal. They can be binned relative to any arbitrary vector with the FRV option.

b. Gaussian energy broadening: The GEB option can be used to better simulate a physical radiation detector in which energy peaks exhibit Gaussian energy broadening. The tallied energy is broadened by sampling from the Gaussian:

$$f(E) = Ce^{-\left(\frac{E-E_o}{A}\right)^2},$$

where  $E$  = the broadened energy;  
 $E_o$  = the unbroadened energy of the tally;  
 $C$  = a normalization constant; and  
 $A$  = the Gaussian width.

The Gaussian width is related to the full width half maximum (FWHM) by

$$A = \frac{FWHM}{2\sqrt{\ln 2}} = .60056120439322 * FWHM$$

The desired FWHM is specified by the user-provided constants, a, b, and c, where

$$FWHM = a + b\sqrt{E + cE^2}.$$

The FWHM is defined as  $FWHM = 2(E_{FWHM} - E_o)$ ,

where  $E_{FWHM}$  is such that  $f(E_{FWHM}) = \frac{1}{2} f(E_o)$

and  $f(E_o)$  is the maximum value of  $f(E)$ .

c. Time convolution: Because the geometry and material compositions are independent of time, except in the case of time-dependent temperatures, the expected tally  $T(t, t + \tau)$  at time  $t + \tau$  from a source particle emitted at time  $t$  is identical to the expected tally  $T(0, \tau)$  from a source particle emitted at time 0. Thus, if a calculation is performed with all source particles started at  $t = 0$ , one has an estimate of  $T(0, \tau)$  and the tallies  $T_{Q_i}$  from a number of time-distributed sources.  $Q_i(t)$  can be calculated at time  $\eta$  as

$$T_{Q_i}(\eta) = \int_a^b Q_i(t)T(t, \eta)dt = \int_a^b Q_i(t)T(0, \eta - t)dt,$$

by sampling  $t$  from  $Q_i(t)$  and recording each particle's tally (shifted by  $t$ ), or after the calculation by integrating  $Q_i(t)$  multiplied by the histogram estimate of  $T(0, \eta - t)$ . The latter method is used in MCNP to simulate a source as a square pulse starting at time  $a$  and ending at time  $b$ , where  $a$  and  $b$  are supplied by the TMC option.



## CHAPTER 2

### TALLIES

d. Binning by the number of collisions: Tallies can be binned by the number of collisions that caused them with the INC option and an FU card. A current tally, for example, can be subdivided into the portions of the total current coming from particles that have undergone zero, one, two, three, ... collisions before crossing the surface. In a point detector tally, the user can determine what portion of the score came from particles having their 1st, 2nd, 3rd, ... collision. Collision binning is particularly useful with the exponential transform because the transform reduces variance by reducing the number of collisions. If particles undergoing many collisions are the major contributor to a tally, then the exponential transform is ill-advised. When the exponential transform is used, the portion of the tally coming from particles having undergone many collisions should be small.

e. Binning by detector cell: The ICD option with an FU card is used to determine what portion of a detector tally comes from what cells. This information is similar to the detector diagnostics print, but the FT card can be combined with energy and other binning cards. The contribution to the normalized rather than unnormalized tally is printed.

f. Binning by source distribution: The SCX and SCD options are used to bin a tally score according to what source distribution caused it.

g. Binning by multigroup particle type: The PTT option with an FU card is used to bin multigroup tallies by particle type. The MCNP multigroup treatment is available for neutron, coupled neutron/photon, and photon problems. However, charged particles or any other combinations of particles can be run with the various particles masquerading as neutrons and are printed out in the OUTP file as if they were neutrons. With the PTT option, the tallies can be segregated into particle types by entering atomic weights in units of MeV on the FU card. The FU atomic weights must be specified to within 0.1% of the true atomic weight in MeV units: thus FU .511 specifies an electron, but .510 is not recognized.

h. Binning by particle charge: The ELC option allows binning F1 current tallies by particle charge. There are three ELC options:

1. cause negative electrons to make negative scores and positrons to make positive scores. Note that by tallying positive and negative numbers the relative error is unbounded and this tally may be difficult to converge;
2. segregate electrons and positrons into separate bins plus a total bin. There will be three bins (positron, electron, and total) all with positive scores. The total bin will be the same as the single tally bin without the ELC option.
3. segregate electrons and positrons into separate bins plus a total bin, with the electron bin scores being all negative to reflect their charge. The bins will be for positrons (positive scores), electrons (negative scores), and total. The total bin will be the same as the single bin with the first ELC option above (usually with negative scores because there are more electrons than positrons).

**5. User modification**

If the above capabilities do not provide exactly what is desired, tallies can be modified by a user-supplied TALLYX subroutine (FU card). As with a user-supplied SOURCE subroutine, which lets the user provide his own specialized source, the TALLYX subroutine lets the user modify any tally, with all the programming changes conveniently located in a single subroutine.

**6. Tally output format**

Not only can users change the contents of MCNP tallies, the output format can be modified as well. Any desired descriptive comment can be added to the tally title by the tally comment (FC) card. The printing order can be changed (FQ card) so that instead of, for instance, getting the default output blocks in terms of time vs. energy, they could be printed in blocks of segment vs. cosine. The tally bin that is monitored for the tally fluctuation chart printed at the problem end and used in the statistical analysis of the tally can be selected (TF card). Detector tally diagnostic prints are controlled with the DD card. Finally, the PRINT card controls what optional tables are displayed in the output file.

**VI. *ESTIMATION OF THE MONTE CARLO PRECISION***

Monte Carlo results represent an average of the contributions from many histories sampled during the course of the problem. An important quantity equal in stature to the Monte Carlo answer (or tally) itself is the statistical error or uncertainty associated with the result. The importance of this error and its behavior vs. the number of histories cannot be overemphasized because the user not only gains insight into the quality of the result, but also can determine if a tally appears statistically well behaved. If a tally is not well behaved, the estimated error associated with the result generally will not reflect the true confidence interval of the result and, thus, the answer could be completely erroneous. MCNP contains several quantities that aid the user in assessing the quality of the confidence interval.<sup>86</sup>

The purpose of this section is to educate MCNP users about the proper interpretation of the MCNP estimated mean, relative error, variance of the variance, and history score probability density function. Carefully check tally results and the associated tables in the tally fluctuation charts to ensure a well-behaved and properly converged tally.

**A. *Monte Carlo Means, Variances, and Standard Deviations***

Monte Carlo results are obtained by sampling possible random walks and assigning a score  $x_i$  (for example,  $x_i$  = energy deposited by the  $i^{\text{th}}$  random walk) to each random walk. Random walks typically will produce a range of scores depending on the tally selected and the variance reduction chosen.

## CHAPTER 2 ESTIMATION OF THE MONTE CARLO PRECISION

Suppose  $f(x)$  is the history score probability density function for selecting a random walk that scores  $x$  to the tally being estimated. The true answer (or mean) is the expected value of  $x$ ,  $E(x)$ , where

$$E(x) = \int xf(x)dx = \text{true mean.}$$

The function  $f(x)$  is seldom explicitly known; thus,  $f(x)$  is implicitly sampled by the Monte Carlo random walk process. The true mean then is estimated by the sample mean  $\bar{x}$  where

$$\bar{x} = \frac{1}{N} \sum_{i=1}^N x_i \quad , \quad (2.15)$$

where  $x_i$  is the value of  $x$  selected from  $f(x)$  for the  $i^{\text{th}}$  history and  $N$  is the number of histories calculated in the problem. The Monte Carlo mean  $\bar{x}$  is the average value of the scores  $x_i$  for all the histories calculated in the problem. The relationship between  $E(x)$  and  $\bar{x}$  is given by the Strong Law of Large Numbers<sup>1</sup> that states that if  $E(x)$  is finite,  $\bar{x}$  tends to the limit  $E(x)$  as  $N$  approaches infinity.

The variance of the population of  $x$  values is a measure of the spread in these values and is given by<sup>1</sup>

$$\sigma^2 = \int (x - E(x))^2 f(x)dx = E(x^2) - (E(x))^2 \quad .$$

The square root of the variance is  $\sigma$ , which is called the standard deviation of the population of scores. As with  $E(x)$ ,  $\sigma$  is seldom known but can be estimated by Monte Carlo as  $S$ , given by (for large  $N$ )

$$S^2 = \frac{\sum_{i=1}^N (x_i - \bar{x})^2}{N - 1} \sim \overline{x^2} - \bar{x}^2 \quad (2.16a)$$

and

$$\overline{x^2} = \frac{1}{N} \sum_{i=1}^N x_i^2 \quad . \quad (2.16b)$$

The quantity  $S$  is the estimated standard deviation of the population of  $x$  based on the values of  $x_i$  that were actually sampled.

The estimated variance of  $\bar{x}$  is given by

$$S_{\bar{x}}^2 = \frac{S^2}{N} . \quad (2.17)$$

These formulae do not depend on any restriction on the distribution of  $x$  or  $\bar{x}$  (such as normality) beyond requiring that  $E(x)$  and  $\sigma^2$  exist and are finite. The estimated standard deviation of the mean  $\bar{x}$  is given by  $S_{\bar{x}}$ .

It is important to note that  $S_{\bar{x}}$  is proportional to  $1/\sqrt{N}$ , which is the inherent drawback to the Monte Carlo method. To halve  $S_{\bar{x}}$ , four times the original number of histories must be calculated, a calculation that can be computationally expensive. The quantity  $S_{\bar{x}}$  can also be reduced for a specified  $N$  by making  $S$  smaller, reducing the inherent spread of the tally results. This can be accomplished by using variance reduction techniques such as those discussed in section VII of this chapter.

**B. Precision and Accuracy**

There is an extremely important difference between precision and accuracy of a Monte Carlo calculation. As illustrated in Fig. 2-10, precision is the uncertainty in  $\bar{x}$  caused by the statistical

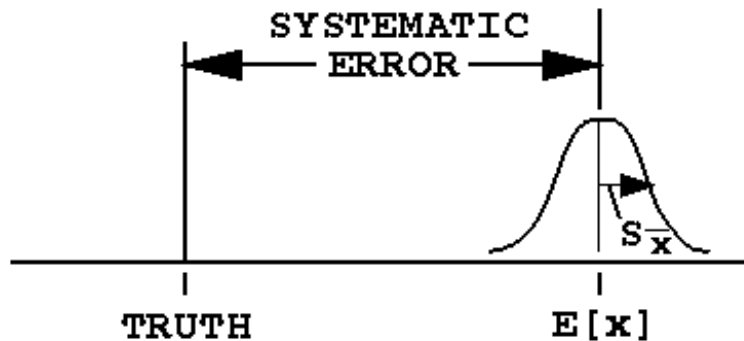

**Figure 2-10.**

fluctuations of the  $x_i$ 's for the portion of physical phase space sampled by the Monte Carlo process. Important portions of physical phase space might not be sampled because of problem cutoffs in time or energy, inappropriate use of variance reduction techniques, or an insufficient sampling of important low-probability events. Accuracy is a measure of how close the expected value of  $\bar{x}$ ,  $E(x)$ , is to the true physical quantity being estimated. The difference between this true value and  $E(x)$  is called the systematic error, which is seldom known. Error or uncertainty estimates for the results of Monte Carlo calculations refer only to the precision of the result and not to the accuracy. It is quite possible to calculate a highly precise result that is far from the physical truth because nature has not been modeled faithfully.

## CHAPTER 2

### ESTIMATION OF THE MONTE CARLO PRECISION

#### 1. Factors Affecting Problem Accuracy

Three factors affect the accuracy of a Monte Carlo result: (1) the code, (2) problem modeling, and (3) the user. Code factors encompass: the physics features included in a calculation as well as the mathematical models used; uncertainties in the data, such as the transport and reaction cross sections, Avogadro's number, atomic weights, etc.; the quality of the representation of the differential cross sections in energy and angle; and coding errors (bugs). All of the applicable physics must be included in a calculation to produce accurate results. Even though the evaluations are not perfect, more faithful representation of the evaluator's data should produce more accurate results. The descending order of preference for Monte Carlo data for calculations is continuous energy, thinned continuous energy, discrete reaction, and multigroup. Coding errors can always be a problem because no large code is bug-free. MCNP, however, is a very mature, heavily used production code. With steadily increasing use over the years, the likelihood of a serious coding error continues to diminish.

The second area, problem-modeling factors, can quite often contribute to a decrease in the accuracy of a calculation. Many calculations produce seemingly poor results because the model of the energy and angular distribution of the radiation source is not adequate. Two other problem-modeling factors affecting accuracy are the geometrical description and the physical characteristics of the materials in the problem.

The third general area affecting calculational accuracy involves user errors in the problem input or in user-supplied subroutines and patches to MCNP. The user can also abuse variance reduction techniques such that portions of the physical phase space are not allowed to contribute to the results. Checking the input and output carefully can help alleviate these difficulties. A last item that is often overlooked is a user's thorough understanding of the relationship of the Monte Carlo tallies to any measured quantities being calculated. Factors such as detector efficiencies, data reduction and interpretation, etc., must be completely understood and included in the calculation, or the comparison is not meaningful.

#### 2. Factors Affecting Problem Precision

The precision of a Monte Carlo result is affected by four user-controlled choices: (1) forward vs. adjoint calculation, (2) tally type, (3) variance reduction techniques, and (4) number of histories run.

The choice of a forward vs. adjoint calculation depends mostly on the relative sizes of the source and detector regions. Starting particles from a small region is easy to do, whereas transporting particles to a small region is generally hard to do. Because forward calculations transport particles from source to detector regions, forward calculations are preferable when the detector (or tally) region is large and the source region is small. Conversely, because adjoint calculations transport particles backward from the detector region to the source region, adjoint calculations

## CHAPTER 2

### ESTIMATION OF THE MONTE CARLO PRECISION

are preferable when the source (or tally) region is large and the detector region is small. MCNP can be run in multigroup adjoint mode. There is no continuous-energy adjoint capability.

As alluded to above, the smaller the tally region, the harder it becomes to get good tally estimates. An efficient tally will average over as large a region of phase space as practical. In this connection, tally dimensionality is extremely important. A one-dimensional tally is typically 10 to 100 times easier to estimate than a two-dimensional tally, which is 10 to 100 times easier than a three-dimensional tally. This fact is illustrated in Fig. 2-15 later in this section.

Variance reduction techniques can be used to improve the precision of a given tally by increasing the nonzero tallying efficiency and by decreasing the spread of the nonzero history scores. These two components are depicted in a hypothetical  $f(x)$  shown in Fig. 2-11. See page 2-113 for more

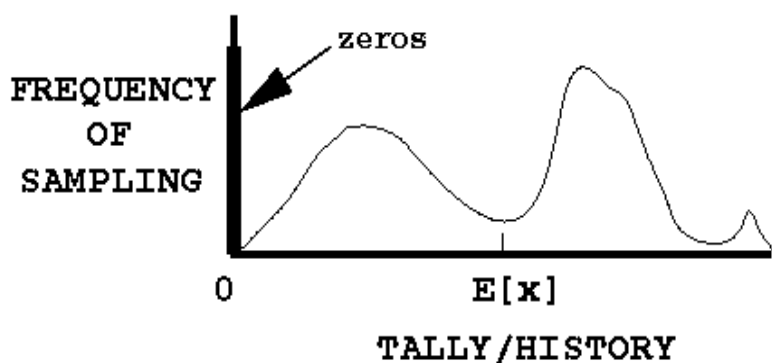

**Figure 2-11.**

discussion about the empirical  $f(x)$  for each tally fluctuation chart bin. A calculation will be more precise when the history-scoring efficiency is high and the variance of the nonzero scores is low. The user should strive for these conditions in difficult Monte Carlo calculations. Examples of these two components of precision are given on page 2-109.

More histories can be run to improve precision (see section C following). Because the precision is proportional to  $1/\sqrt{N}$ , running more particles is often costly in computer time and therefore is viewed as the method of last resort for difficult problems.

#### **C. The Central Limit Theorem and Monte Carlo Confidence Intervals**

To define confidence intervals for the precision of a Monte Carlo result, the Central Limit Theorem<sup>1</sup> of probability theory is used, stating that

$$\lim_{N \rightarrow \infty} Pr \left[ E(x) + \alpha \frac{\sigma}{\sqrt{N}} < \bar{x} < E(x) + \beta \frac{\sigma}{\sqrt{N}} \right] = \frac{1}{2\pi} \int_{\alpha}^{\beta} e^{-t^2/2} dt \quad ,$$

## CHAPTER 2 ESTIMATION OF THE MONTE CARLO PRECISION

where  $\alpha$  and  $\beta$  can be any arbitrary values and  $\text{Pr}[Z]$  means the probability of  $Z$ . In terms of the estimated standard deviation of  $\bar{x}$ ,  $S_{\bar{x}}$ , this may be rewritten in the following approximation for large  $N$ :

$$\text{Pr}\left[\alpha S_{\bar{x}} < \frac{\bar{x} - E(x)}{\sigma \sqrt{N}} < \beta S_{\bar{x}}\right] \sim \frac{1}{\sqrt{2\pi}} \int_{\alpha}^{\beta} e^{-t^2/2} dt \quad .$$

This crucial theorem states that for large values of  $N$  (that is, as  $N$  tends to infinity) and identically distributed independent random variables  $x_i$  with finite means and variances, the distribution of the  $\bar{x}$ 's approaches a normal distribution. Therefore, for any distribution of tallies (an example is shown in Fig. 2-11), the distribution of resulting  $\bar{x}$ 's will be approximately normally distributed, as shown in Fig. 2-10, with a mean of  $E(x)$ . If  $S$  is approximately equal to  $\sigma$ , which is valid for a statistically significant sampling of a tally (i.e,  $N$  has tended to infinity), then

$$\bar{x} - 2S_{\bar{x}} < E(x) < \bar{x} + S_{\bar{x}}, \sim 68\% \text{ of the time and} \quad (2.18a)$$

$$\bar{x} - 2S_{\bar{x}} < E(x) < \bar{x} + 2S_{\bar{x}}, \sim 95\% \text{ of the time} \quad (2.18b)$$

from standard tables for the normal distribution function. Eq. (2.18a) is a 68% confidence interval and Eq. (2.18b) is a 95% confidence interval.

The key point about the validity of these confidence intervals is that the physical phase space must be adequately sampled by the Monte Carlo process. If an important path in the geometry or a window in the cross sections, for example, has not been well sampled, both  $\bar{x}$  and  $S_{\bar{x}}$  will be unknowingly incorrect and the results will be wrong, usually tending to be too small. The user must take great care to be certain that adequate sampling of the source, transport, and any tally response functions have indeed taken place. Additional statistical quantities to aid in the assessment of proper confidence intervals are described in later portions of section VI.

### ***D. Estimated Relative Errors in MCNP***

All standard MCNP tallies are normalized to be per starting particle history (except for some criticality calculations) and are printed in the output with a second number, which is the estimated relative error defined as

$$R \equiv S_{\bar{x}}/\bar{x} \quad (2.19a)$$

The relative error is a convenient number because it represents statistical precision as a fractional result with respect to the estimated mean.

**CHAPTER 2**  
**ESTIMATION OF THE MONTE CARLO PRECISION**

Combining Eqs. (2.15), (2.16), and (2.17),  $R$  can be written (for large  $N$ ) as

$$R = \left[ \frac{1}{N} \left( \frac{\overline{x^2}}{\bar{x}^2} - 1 \right) \right]^{1/2} = \left[ \frac{\sum_{i=1}^N x_i^2}{(\sum_{i=1}^N x_i)^2} - \frac{1}{N} \right]^{1/2} . \quad (2.19b)$$

Several important observations about the relative error can be made from Eq. (2.19b). First, if all the  $x_i$ 's are nonzero and equal,  $R$  is zero. Thus, low-variance solutions should strive to reduce the spread in the  $x_i$ 's. If the  $x_i$ 's are all zero,  $R$  is defined to be zero. If only one nonzero score is made,  $R$  approaches unity as  $N$  becomes large. Therefore, for  $x_i$ 's of the same sign,  $S_{\bar{x}}$  can never be greater than  $\bar{x}$  because  $R$  never exceeds unity. For positive and negative  $x_i$ 's,  $R$  can exceed unity. The range of  $R$  values for  $x_i$ 's of the same sign is therefore between zero and unity.

To determine what values of  $R$  lead to results that can be stated with confidence using Eqs. (2.6), consider Eq. (2.19b) for a difficult problem in which nonzero scores occur very infrequently. In this case,

$$\frac{1}{N} \ll \frac{\sum_{i=1}^N x_i^2}{(\sum_{i=1}^N x_i)^2} . \quad (2.20a)$$

For clarity, assume that there are  $n$  out of  $N$  ( $n \ll N$ ) nonzero scores that are identical and equal to  $x$ . With these two assumptions,  $R$  for "difficult problems" becomes

$$R_{D.P.} \sim \left[ \frac{nx^2}{n^2 x^2} \right]^{1/2} = \frac{1}{\sqrt{n}}, n \ll N . \quad (2.20b)$$

This result is expected because the limiting form of a binomial distribution with infrequent nonzero scores and large  $N$  is the Poisson distribution, which is the form in Eq. (2.20b) used in detector "counting statistics."

**TABLE 2.2:**  
**Estimated Relative Error  $R$  vs. Number of Identical Tallies  $n$  for Large  $N$**

$n$	1	4	16	25	100	400
$R$	1.0	0.5	0.25	0.20	0.10	0.05

Through use of Eqs. (2.8), a table of  $R$  values versus the number of tallies or "counts" can be generated as shown in Table 2.2. A relative error of 0.5 is the equivalent of four counts, which is hardly adequate for a statistically significant answer. Sixteen counts is an improvement,



**CHAPTER 2**  
**ESTIMATION OF THE MONTE CARLO PRECISION**

reducing  $R$  to 0.25, but still is not a large number of tallies. The same is true for  $n$  equals 25. When  $n$  is 100,  $R$  is 0.10, so the results should be much improved. With 400 tallies, an  $R$  of 0.05 should be quite good indeed.

Based on this qualitative analysis and the experience of Monte Carlo practitioners, Table 2.3 presents the recommended interpretation of the estimated  $1\sigma$  confidence interval  $\bar{x}(1 \pm R)$  for various values of  $R$  associated with an MCNP tally. These guidelines were determined empirically, based on years of experience using MCNP on a wide variety of problems. Just before the tally fluctuation charts, a “Status of Statistical Checks” table prints how many tally bins of each tally have values of  $R$  exceeding these recommended guidelines.

**TABLE 2.3:**  
**Guidelines for Interpreting the Relative Error  $R^a$**

Range of $R$	Quality of the Tally
0.5 to 1	Garbage
0.2 to 0.5	Factor of a few
0.1 to 0.2	Questionable
< 0.10	Generally reliable except for point detector
< 0.05	Generally reliable for point detector

<sup>a</sup> $R = S_{\bar{x}}/\bar{x}$  and represents the estimated statistical relative error at the  $1\sigma$  level. These interpretations of  $R$  assume that all portions of the problem phase space have been well sampled by the Monte Carlo process.

Point detector tallies generally require a smaller value of  $R$  for valid confidence interval statements because some contributions, such as those near the detector point, are usually extremely important and may be difficult to sample well. Experience has shown that for  $R$  less than 0.05, point detector results are generally reliable. For an  $R$  of 0.10, point detector tallies may only be known within a factor of a few and sometimes not that well (see the pathological example on page 2–123.)

MCNP calculates the relative error for each tally bin in the problem using Eq. (2.19b). Each  $x_i$  is defined as the total contribution from the  $i^{\text{th}}$  starting particle and all resulting progeny. This definition is important in many variance reduction methods, multiplying physical processes such as fission or  $(n, xn)$  neutron reactions that create additional neutrons, and coupled neutron/ photon/electron problems. The  $i^{\text{th}}$  source particle and its offspring may thus contribute many times to a tally and all of these contributions are correlated because they are from the same source particle.

Figure 2.12 represents the MCNP process of calculating the first and second moments of each tally bin and relevant totals using three tally storage blocks of equal length for each tally bin. The

## CHAPTER 2

### ESTIMATION OF THE MONTE CARLO PRECISION

hypothetical grid of tally bins in the bottom half of Fig. 2-12 has 24 tally bins including the time and energy totals. During the course of the  $i^{\text{th}}$  history, sums are performed in the first MCNP tally storage block. Some of the tally bins receive no contributions and others receive one or more contributions. At the conclusion of the  $i^{\text{th}}$  history, the sums are added to the second MCNP tally storage block. The sums in the first MCNP tally storage block are squared and added to the third tally storage block. The first tally storage block is then filled with zeros and history  $i + 1$  begins. After the last history  $N$ , the estimated tally means are computed using the second MCNP tally storage block and Eq. (2.15). The estimated relative errors are calculated using the second and third MCNP tally storage blocks and Eq. (2.19b). This method of estimating the statistical uncertainty of the result produces the best estimate because the batch size is one, which minimizes the variance of the variance.<sup>87,88</sup>

Note that there is no guarantee that the estimated relative error will decrease inversely proportional to the  $\sqrt{N}$  as required by the Central Limit Theorem because of the statistical nature of the tallies. Early in the problem,  $R$  will generally have large statistical fluctuations. Later, infrequent large contributions may cause fluctuations in  $S_{\bar{x}}$  and to a lesser extent in  $\bar{x}$  and therefore in  $R$ . MCNP calculates a *FOM* for one bin of each numbered tally to aid the user in determining the statistical behavior as a function of  $N$  and the efficiency of the tally.

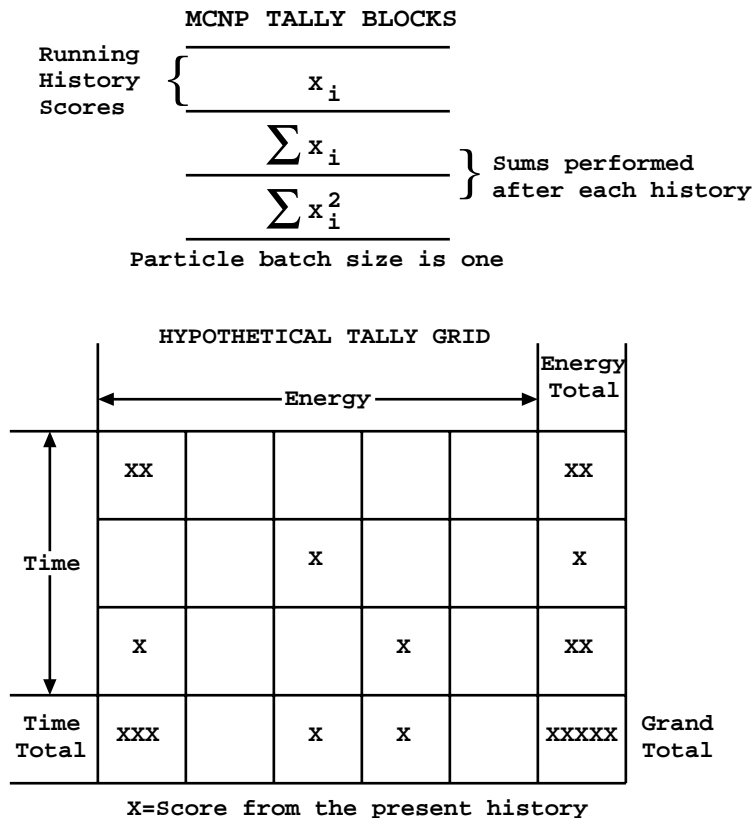

**Figure 2-12.**

**CHAPTER 2**  
**ESTIMATION OF THE MONTE CARLO PRECISION**

*E. MCNP Figure of Merit*

The estimated relative error squared  $R^2$  should be proportional to  $1/N$ , as shown by Eq. (2.19a). The computer time  $T$  used in an MCNP problem should be directly proportional to  $N$ ; therefore,  $R^2T$  should be approximately a constant within any one Monte Carlo run. It is convenient to define a figure of merit ( $FOM$ ) of a tally to be

$$FOM \equiv \frac{1}{R^2 T} \quad (2.21a)$$

MCNP prints the  $FOM$  for one bin of each numbered tally as a function of  $N$ , where the unit of computer time  $T$  is minutes. The table is printed in particle increments of 1000 up to 20,000 histories. Between 20,000 and 40,000 histories, the increment is doubled to 2000. This trend continues, producing a table of up to 20 entries. The default increment can be changed by the 5th entry on the PRDMP card.

The  $FOM$  is a very important statistic about a tally bin and should be studied by the user. It is a tally reliability indicator in the sense that if the tally is well behaved, the  $FOM$  should be approximately a constant with the possible exception of statistical fluctuations very early in the problem. An order-of-magnitude estimate of the expected fractional statistical fluctuations in the  $FOM$  is  $2R$ . This result assumes that both the relative statistical uncertainty in the relative error is of the order of the relative error itself and the relative error is small compared to unity. The user should always examine the tally fluctuation charts at the end of the problem to check that the  $FOM$ s are approximately constant as a function of the number of histories for each tally.

The numerical value of the  $FOM$  can be better appreciated by considering the relation

$$R = 1/\sqrt{FOM * T} \quad (2.21b)$$

Table 2.4 shows the expected value of  $R$  that would be produced in a one-minute problem ( $T = 1$ ) as a function of the value of the  $FOM$ . It is clearly advantageous to have a large  $FOM$  for a problem because the computer time required to reach a desired level of precision is proportionally reduced. Examination of Eq. (2.21b) shows that doubling the  $FOM$  for a problem will reduce the computer time required to achieve the same  $R$  by a factor of two.

**TABLE 2.4:**  
 **$R$  Values as a Function of the  $FOM$  for  $T = 1$  Minute**

$FOM$	1	10	100	1000	10000
$R$	1.0	0.32	0.10	0.032	0.010

In summary, the *FOM* has three uses. The most important use is as a tally reliability indicator. If the *FOM* is not approximately a constant (except for statistical fluctuations early in the problem), the confidence intervals may not overlap the expected score value,  $E(x)$ , the expected fraction of the time. A second use for the *FOM* is to optimize the efficiency of the Monte Carlo calculation by making several short test runs with different variance reduction parameters and then selecting the problem with the largest *FOM*. Remember that the statistical behavior of the *FOM* (i.e.,  $R$ ) for a small number of histories may cloud the selection of techniques competing at the same level of efficiency. A third use for the *FOM* is to estimate the computer time required to reach a desired value of  $R$  by using  $T \sim 1/R^2 FOM$ .

***F. Separation of Relative Error into Two Components***

Three factors that affect the efficiency of a Monte Carlo problem are (1) history-scoring efficiency, (2) dispersions in nonzero history scores, and (3) computer time per history. All three factors are included in the *FOM*. The first two factors control the value of  $R$ ; the third is  $T$ .

The relative error can be separated into two components: the nonzero history-scoring efficiency component  $R_{eff}^2$  and the intrinsic spread of the nonzero  $x_i$  scores  $R_{int}^2$ . Defining  $q$  to be the fraction of histories producing nonzero  $x_i$ 's, Eq. 2.19b can be rewritten as

$$R = \frac{\sum_{i=1}^N x_i^2}{(\sum_{i=1}^N x_i)^2} - \frac{1}{N} = \frac{\sum_{x_i \neq 0} x_i^2}{(\sum_{x_i \neq 0} x_i)^2} - \frac{1}{N} = \frac{\sum_{x_i \neq 0} x_i^2}{(\sum_{x_i \neq 0} x_i)^2} - \frac{1}{qN} + \frac{1-q}{qN} . \quad (2.22a)$$

Note by Eq. 2.19b that the first two terms are the relative error of the  $qN$  nonzero scores. Thus defining,

$$R_{int}^2 = \frac{\sum_{x_i \neq 0} x_i^2}{(\sum_{x_i \neq 0} x_i)^2} - \frac{1}{qN} \quad \text{and} \quad (2.22b)$$

$$R_{eff}^2 = (1-q)/(qN) \quad \text{yields} \quad (2.22c)$$

$$R^2 = R_{eff}^2 + R_{int}^2 . \quad (2.22d)$$

For identical nonzero  $x_i$ 's,  $R_{int}^2$  is zero and for a 100% scoring efficiency,  $R_{eff}^2$  is zero. It is usually possible to increase  $q$  for most problems using one or more of the MCNP variance reduction techniques. These techniques alter the random walk sampling to favor those particles that produce a nonzero tally. The particle weights are then adjusted appropriately so that the expected tally is preserved. This topic is described in Sec. VII (Variance Reduction) beginning

**CHAPTER 2**  
**ESTIMATION OF THE MONTE CARLO PRECISION**

on page 2-127 . The sum of the two terms of Eq. (2.22d) produces the same result as Eq. (2.19b). Both  $R_{int}^2$  and  $R_{eff}^2$  are printed for the tally fluctuation chart bin of each tally so that the dominant component of  $R$  can be identified as an aid to making the calculation more efficient.

These equations can be used to better understand the effects of scoring inefficiency; that is, those histories that do not contribute to a tally. Table 2.5 shows the expected values of  $R_{eff}$  as a function of  $q$  and the number of histories  $N$ . This table is appropriate for identical nonzero scores and represents the theoretical minimum relative error possible for a specified  $q$  and  $N$ . It is no surprise that small values of  $q$  require a compensatingly large number of particles to produce precise results.

**TABLE 2.5:**  
**Expected Values of  $R_{eff}$  as a Function of  $q$  and  $N$**

$q$ $N$	0.001	0.01	0.1	0.5
$10^5$	0.999	0.315	0.095	0.032
$10^4$	0.316	0.099	0.030	0.010
$10^5$	0.100	0.031	0.009	0.003
$10^6$	0.032	0.010	0.003	0.001

A practical example of scoring inefficiency is the case of infrequent high-energy particles in a down-scattering-only problem. If only a small fraction of all source particles has an energy in the highest energy tally bin, the dominant component of the relative error will probably be the scoring efficiency because only the high-energy source particles have a nonzero probability of contributing to the highest energy bin. For problems of this kind, it is often useful to run a separate problem starting only high-energy particles from the source and to raise the energy cutoff. The much-improved scoring efficiency will result in a much larger  $FOM$  for the high-energy tally bins.

To further illustrate the components of the relative error, consider the five examples of selected discrete probability density functions shown in Fig. 2-13. Cases I and II have no dispersion in the nonzero scores, cases III and IV have 100% scoring efficiency, and case V contains both elements contributing to  $R$ . The most efficient problem is case III. Note that the scoring inefficiency contributes 75% to  $R$  in case V, the second worst case of the five.

FIVE CASES WITH A MEAN OF 0.5

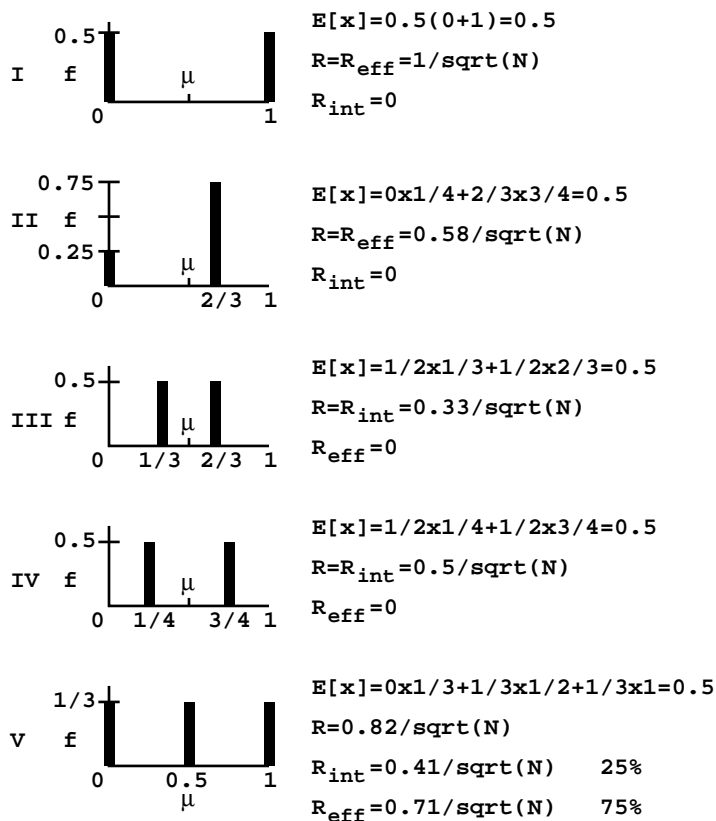

**Figure 2-13.**

**G. Variance of the Variance**

Previous sections have discussed the relative error  $R$  and figure of merit FOM as measures of the quality of the mean. A quantity called the relative variance of the variance (VOV) is another useful tool that can assist the user in establishing more reliable confidence intervals. The VOV is the estimated relative variance of the estimated  $R$ . The VOV involves the estimated third and fourth moments of the empirical history score probability density function (PDF)  $f(x)$  and is much more sensitive to large history score fluctuations than is  $R$ . The magnitude and NPS behavior of the VOV are indicators of tally fluctuation chart (TFC) bin convergence. Early work was done by Estes and Cashwell<sup>87</sup> and Pederson<sup>89</sup> later reinvestigated this statistic to determine its usefulness.

The VOV is a quantity that is analogous to the square of the  $R$  of the mean, except it is for  $R$  instead of the mean. The estimated relative VOV of the mean is defined as

**CHAPTER 2**  
**ESTIMATION OF THE MONTE CARLO PRECISION**

$$VOV = S^2(S_{\bar{x}}^2)/S_{\bar{x}}^4$$

where  $S_{\bar{x}}^2$  is the estimated variance of  $\bar{x}$  and  $S^2(S_{\bar{x}}^2)$  is the estimated variance in  $S_{\bar{x}}^2$ . The VOV is a measure of the relative statistical uncertainty in the estimated R and is important because S must be a good approximation of  $\sigma$  to use the Central Limit Theorem to form confidence intervals.

The VOV for a tally bin<sup>89</sup> is

$$VOV = \Sigma(x_i - \bar{x})^4 / (\Sigma(x_i - \bar{x})^2)^2 - 1/N . \tag{2.23}$$

This is the fourth central moment minus the second central moment squared normed by the product of N and the second central moment squared.

When Eq. (2.23) is expanded in terms of sums of powers of  $x_i$ , it becomes

$$VOV = \frac{\Sigma x_i^4 - 4\Sigma x_i \Sigma x_i^3 / N + 6\Sigma x_i^2 (\Sigma x_i)^2 / N^2 - 3(\Sigma x_i)^4 / N^3}{(\Sigma x_i^2 - (\Sigma x_i)^2 / N)^2} - \frac{1}{N}$$

or

$$VOV = \frac{\Sigma x_i^4 - 4\Sigma x_i \Sigma x_i^3 / N + 8\Sigma x_i^2 (\Sigma x_i)^2 / N^2 - 4(\Sigma x_i)^4 / N^3 - (\Sigma x_i^2)^2 / N}{(\Sigma x_i^2 - (\Sigma x_i)^2 / N)^2} \tag{2.24}$$

Now consider the truncated Cauchy formula for the following analysis. The truncated Cauchy is similar in shape to some difficult Monte Carlo tallies. After numerous statistical experiments on sampling a truncated positive Cauchy distribution

$$Cauchy f(x) = 2/\pi(1 + x^2), 0 \leq x \leq x_{max} , \tag{2.25}$$

it is concluded that the VOV should be below 0.1 to improve the probability of forming a reliable confidence interval. The quantity 0.1 is a convenient value and is why the VOV is used for the statistical check and not the square root of the VOV (R of the R). Multiplying numerator and denominator of Eq. (2.24) by  $1/N$  converts the terms into  $\bar{x}^n$  averages and shows that the VOV is expected to decrease as  $1/N$ .

It is interesting to examine the VOV for the  $n$  identical history scores  $x$  ( $n \ll N$ ) that were used to analyze R in Table 2.2, page 2–105. The VOV behaves as  $1/n$  in this limit. Therefore, ten

identical history scores would be enough to satisfy the VOV criterion, a factor of at least ten less than the R criterion. There are two reasons for this phenomenon: 1) it is more important to know R well than the VOV in forming confidence intervals; and 2) the history scores will ordinarily not be identical and thus the fourth moment terms in the VOV will increase rapidly over the second moment terms in R.

The behavior of the VOV as a function of  $N$  for the TFC bin is printed in the OUTF file. Because the VOV involves third and fourth moments, the VOV is a much more sensitive indicator to large history scores than the R, which is based on first and second moments. The desired VOV behavior is to decrease inversely with  $N$ . This criterion is deemed to be a necessary, but not sufficient, condition for a statistically well-behaved tally result. A tally with a VOV that matches this criteria is NOT guaranteed to produce a high quality confidence interval because undersampling of high scores will also underestimate the higher score moments.

To calculate the VOV of every tally bin, put a nonzero 15th entry on the DBCN card. This option creates two additional history score moment tables each of length MXF in the TAL array to sum  $x_i^3$  and  $x_i^4$  (see Fig. 2-12). This option is not the default because the amount of tally storage will increase by 2/5, which could be prohibitive for a problem with many tally bins. The magnitude of the VOV in each tally bin is reported in the "Status of Statistical Checks" table. History-dependent checks of the VOV of all tally bins can be done by printing the tallies to the output file at some frequency using the PRDMP card.

## ***H. Empirical History Score Probability Density Function $f(x)$***

### **1. Introduction**

This section discusses another statistic that is useful in assessing the quality of confidence intervals from Monte Carlo calculations. Consider a generic Monte Carlo problem with difficult to sample, but extremely important, large history scores. This type of problem produces three possible scenarios.<sup>86</sup>

The first, and obviously desired, case is a correctly converged result that produces a statistically correct confidence interval. The second case is the sampling of an infrequent, but very large, history score that causes the mean and R to increase and the FOM to decrease significantly. This case is easily detectable by observing the behavior of the FOM and the R in the TFCs.

The third and most troublesome case yields an answer that appears statistically converged based on the accepted guidelines described previously, but in fact may be substantially smaller than the correct result because the large history tallies were not well sampled. This situation of too few large history tallies is difficult to detect. The following sections discuss the use of the empirical history score probability density function (PDF)  $f(x)$  to gain insight into the TFC bin result. A pathological example to illustrate the third case follows.



## CHAPTER 2 ESTIMATION OF THE MONTE CARLO PRECISION

### 2. The History Score Probability Density Function $f(x)$

A history score posted to a tally bin can be thought of as having been sampled from an underlying and generally unknown history score PDF  $f(x)$ , where the random variable  $x$  is the score from one complete particle history to a tally bin. The history score can be either positive or negative. The quantity  $f(x)dx$  is the probability of selecting a history score between  $x$  and  $x + dx$  for the tally bin. Each tally bin will have its own  $f(x)$ .

The most general form for expressing  $f(x)$  mathematically is

$$f(x) = f_c(x) + \sum_{i=1}^n p_i \delta(x - x_i) \quad ,$$

where  $f_c(x)$  is the continuous nonzero part and  $\sum_{i=1}^n p_i \delta(x - x_i)$  represents the  $n$  different discrete components occurring at  $x_i$  with probability  $p_i$ . An  $f(x)$  could be composed of either or both parts of the distribution. A history score of zero is included in  $f(x)$  as the discrete component  $\delta(x - 0)$ .

By the definition of a PDF,

$$\int_{-\infty}^{\infty} f(x)dx \equiv 1 \quad .$$

As discussed on page 2-99,  $f(x)$  is used to estimate the mean, variance, and higher moment quantities such as the VOV.

### 3. The Central Limit Theorem and $f(x)$

As discussed on page 2-103, the Central Limit Theorem (CLT) states that the estimated mean will appear to be sampled from a normal distribution with a known standard deviation  $\sigma / (\sqrt{N})$  when  $N$  approaches infinity. In practice,  $\sigma$  is NOT known and must be approximated by the estimated standard deviation  $S$ . The major difficulty in applying the CLT correctly to a Monte Carlo result to form a confidence interval is knowing when  $N$  has approached infinity.

The CLT requires the first two moments of  $f(x)$  to exist. Nearly all MCNP tally estimators (except point detectors with zero neighborhoods in a scattering material and some exponential transform problems) satisfy this requirement. Therefore, the history score PDF  $f(x)$  also exists. One can also examine the behavior of  $f(x)$  for large history scores to assess if  $f(x)$  appears to have been “completely” sampled. If “complete” sampling has occurred, the largest values of the sampled  $x$ 's should have reached the upper bound (if such a bound exists) or should decrease faster than  $1/x^3$  so that  $E(x^2) = \int_{-\infty}^{\infty} x^2 f(x)dx$  exists ( $\sigma$  is assumed to be finite in the CLT).

Otherwise,  $N$  is assumed not to have approached infinity in the sense of the CLT. This is the basis for the use of the empirical  $f(x)$  to assess Monte Carlo tally convergence.

The argument should be made that since  $S$  must be a good estimate of  $\sigma$ , the expected value of the fourth history score moment  $E(x^4) = \int_{-\infty}^{\infty} x^4 f(x) dx$  should exist. It will be assumed that only the second moment needs to exist so that the  $f(x)$  convergence criterion will be relaxed somewhat. Nevertheless, this point should be kept in mind.

#### 4. Analytic Study of $f(x)$ for Two-State Monte Carlo Problems

Booth<sup>90,91</sup> examined the distribution of history scores analytically for both an analog two-state splitting problem and two exponential transform problems. This work provided the theoretical foundation for statistical studies<sup>92</sup> on relevant analytic functions to increase understanding of confidence interval coverage rates for Monte Carlo calculations.

It was found that the two-state splitting problem  $f(x)$  decreases geometrically as the score increases by a constant increment. This is equivalent to a negative exponential behavior for a continuous  $f(x)$ . The  $f(x)$  for the exponential transform problem decreases geometrically with geometrically increasing  $x$ . Therefore, the splitting problem produces a linearly decreasing  $f(x)$  for the history score on a lin-log plot of the score probability versus score. The exponential transform problem generates a linearly decreasing score behavior (with high score negative exponential roll off) on a log-log plot of the score probability versus score plot. In general, the exponential transform problem is the more difficult to sample because of the larger impact of the low probability high scores.

The analytic shapes were compared with a comparable problem calculated with a modified version of MCNP. These shapes of the analytic and empirical  $f(x)$ s were in excellent agreement.<sup>92</sup>

#### 5. Proposed Uses for the Empirical $f(x)$ in Each TFC Bin

Few papers discuss the underlying or empirical  $f(x)$  for Monte Carlo transport problems.<sup>93,86</sup> MCNP provides a visual inspection and analysis of the empirical  $f(x)$  for the TFC bin of each tally. This analysis helps to determine if there are any unsampled regions (holes) or spikes in the empirical history score PDF  $f(x)$  at the largest history scores.

The most important use for the empirical  $f(x)$  is to help determine if  $N$  has approached infinity in the sense of the CLT so that valid confidence intervals can be formed. It is assumed that the underlying  $f(x)$  satisfies the CLT requirements; therefore, so should the empirical  $f(x)$ . Unless there is a largest possible history score, the empirical  $f(x)$  must eventually decrease more steeply than  $x^{-3}$  for the second moment  $\left( \int_{-\infty}^{\infty} x^2 f(x) dx \right)$  to exist. It is postulated<sup>94</sup> that if such

## CHAPTER 2 ESTIMATION OF THE MONTE CARLO PRECISION

decreasing behavior in the empirical  $f(x)$  with no upper bound has not been observed, then  $N$  is not large enough to satisfy the CLT because  $f(x)$  has not been completely sampled. Therefore, a larger  $N$  is required before a confidence interval can be formed. It is important to note that this convergence criterion is NOT affected by any correlations that may exist between the estimated mean and the estimated R. In principle, this lack of correlation should make the  $f(x)$  diagnostic robust in assessing “complete” sampling.

Both the analytic and empirical history score distributions suggest that large score fill-in and one or more extrapolation schemes for the high score tail of the  $f(x)$  could provide an estimate of scores not yet sampled to help assess the impact of the unsampled tail on the mean. The magnitude of the unsampled tail will surely affect the quality of the tally confidence interval.

### 6. Creation of $f(x)$ for TFC Bins

The creation of the empirical  $f(x)$  in MCNP automatically covers nearly all TFC bin tallies that a user might reasonably be expected to make, including the effect of large and small tally multipliers. A logarithmically spaced grid is used for accumulating the empirical  $f(x)$  because the tail behavior is assumed to be of the form  $1/x^n$ ,  $n > 3$  (unless an upper bound for the history scores exists). This grid produces an equal width histogram straight line for  $f(x)$  on a log-log plot that decreases  $n$  decades in  $f(x)$  per decade increase in  $x$ .

Ten bins per  $x$  decade are used and cover the unnormalized tally range from  $10^{-30}$  to  $10^{30}$ . The term “unnormalized” indicates that normalizations that are not performed until the end of the problem, such as cell volume or surface area, are not included in  $f(x)$ . The user can multiply this range at the start of the problem by the 16th entry on the DBCN card when the range is not sufficient. Both history score number and history score for the TFC bin are tallied in the  $x$  grid.

With this  $x$  grid in place, the average empirical  $f(\bar{x}_i)$  between  $x_i$  and  $x_{i+1}$  is defined to be

$$f(\bar{x}_i) = (\text{number of history scores in } i^{\text{th}} \text{ score bin})/N(x^{i+1} - x^i),$$

where  $x^{i+1} = 1.2589 x^i$ . The quantity 1.2589 is  $10^{0.1}$  and comes from 10 equally spaced log bins per decade. The calculated  $f(\bar{x}_i)$ s are available on printed plots or by using the “z” plot option (MC PLOT) with the TFC command mnemonics. Any history scores that are outside the  $x$  grid are counted as either above or below to provide this information to the user.

Negative history scores can occur for some electron charge deposition tallies. The MCNP default is that any negative history score will be lumped into one bin below the lowest history score in the built-in grid (the default is  $1 \times 10^{-30}$ ). If DBCN(16) is negative,  $f(-x)$  will be created from the negative scores and the absolute DBCN(16) value will be used as the score grid multiplier. Positive history scores then will be lumped into the lowest bin because of the sign change.

## CHAPTER 2

### ESTIMATION OF THE MONTE CARLO PRECISION

Figures 2.14 and 2.15 show two simple examples of empirical  $f(x)$ s from MCNP for 10 million histories each. Figure 2.14 is from an energy leakage tally directly from a source that is uniform in energy from 0 to 10 MeV. The analytic  $f(x)$  is a constant 0.1 between 0 and 10 MeV. The empirical  $f(x)$  shows the sampling, which is 0.1 with statistical noise at the lower  $x$  bins where fewer samples are made in the smaller bins.

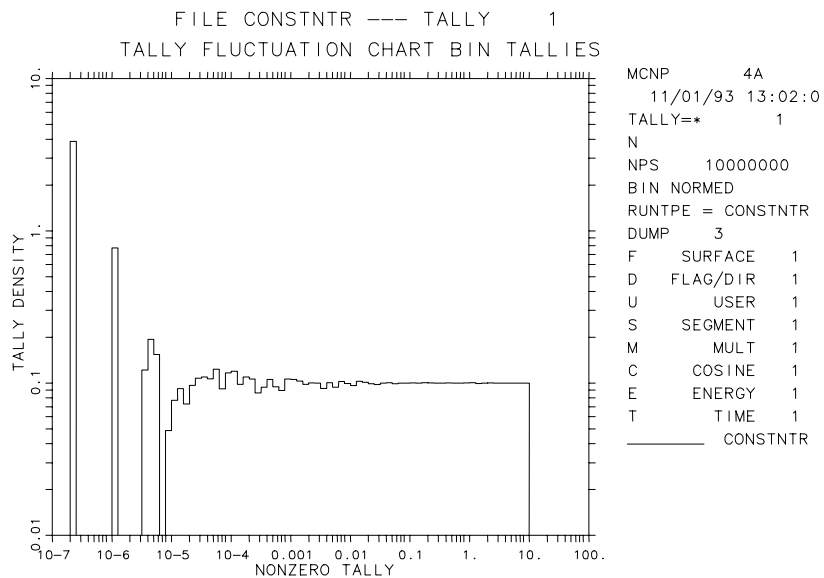

**Figure 2-14.**

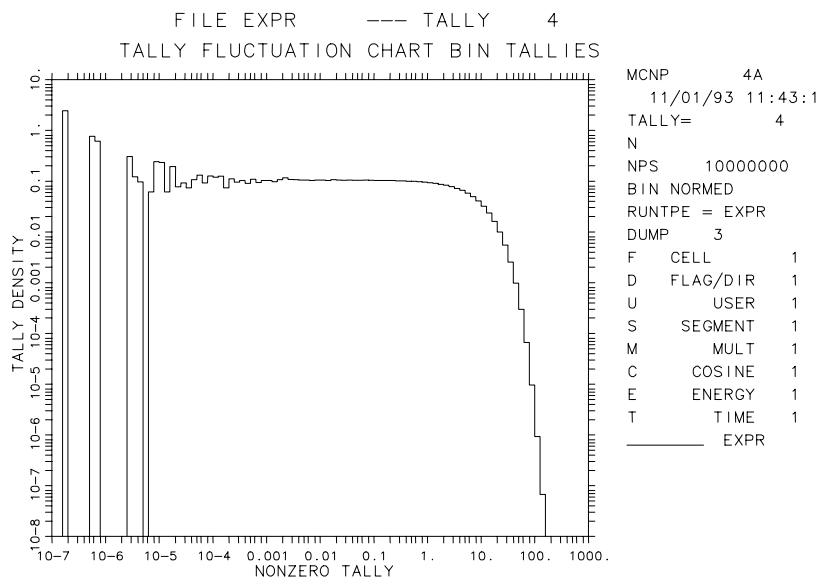

**Figure 2-15.**

## CHAPTER 2

### ESTIMATION OF THE MONTE CARLO PRECISION

Figure 2.15 shows the sampled distance to first collision in a material that has a macroscopic cross section of about  $0.1 \text{ cm}^{-1}$ . This analytic function is a negative exponential given by  $f(x) = \Sigma \exp^{-\Sigma x}$  (see page 2–27) with a mean of 10. The empirical  $f(x)$  transitions from a constant 0.1 at values of  $x$  less than unity to the expected negative exponential behavior.

#### 7. Pareto Fit to the Largest History Scores for the TFC Bin

The slope  $n$  in  $1/x^n$  of the largest history tallies  $x$  must be estimated to determine if and when the largest history scores decrease faster than  $1/x^3$ . The 201 largest history scores for each TFC bin are continuously updated and saved during the calculation. A generalized Pareto function<sup>95</sup>

$$\text{Pareto } f(x) = a^{-1}(1 + kx/a)^{-(1/k)-1}$$

is used to fit the largest  $x$ 's. This function fits a number of extreme value distributions including  $1/x^n$ , exponential ( $k = 0$ ), and constant ( $k = -1$ ). The large history score tail fitting technique uses the robust “simplex” algorithm,<sup>96</sup> which finds the values of  $a$  and  $k$  that best fit the largest history scores by maximum likelihood estimation.

The number of history score tail points used for the Pareto fit is a maximum of 201 points because this provides about 10% precision<sup>95</sup> in the slope estimator at  $n = 3$ . The precision increases for smaller values of  $n$  and vice versa. The number of points actually used in the fit is the lesser of 5% of the nonzero history scores or 201. The minimum number of points used for a Pareto fit is 25 with at least two different values, which requires 500 nonzero history scores with the 5% criterion. If less than 500 history scores are made in the TFC bin, no Pareto fit is made.

From the Pareto fit, the slope of  $f(x_{large})$  is defined to be

$$SLOPE \equiv (1/k) + 1 \quad .$$

A SLOPE value of zero is defined to indicate that not enough  $f(x_{large})$  tail information exists for a SLOPE estimate. The SLOPE is not allowed to exceed a value of 10 (a “perfect score”), which would indicate an essentially negative exponential decrease. If the 100 largest history scores all have values with a spread of less than 1%, an upper limit is assumed to have been reached and the SLOPE is set to 10. The SLOPE should be greater than 3 to satisfy the second moment existence requirement of the CLT. Then,  $f(x)$  will appear to be “completely” sampled and hence  $N$  will appear to have approached infinity.

A printed plot of  $f(x)$  is automatically generated in the OUTP file if the SLOPE is less than 3 (or if any of the other statistical checks described in the next section do not pass). If  $0 < SLOPE < 10$ , several “S’s” appear on the printed plot to indicate the Pareto fit, allowing the quality of the fit to the largest history scores to be assessed visually. If the largest scores are not Pareto in shape, the SLOPE value may not reflect the best estimate of the largest history score

decrease. A new SLOPE can be estimated graphically. A blank or 162 on the PRINT card also will cause printed plots of the first two cumulative moments of the empirical  $f(x)$  to be made. Graphical plots of various  $f(x)$  quantities can be made using the “z” plot option (MCPLOT) with the TFC plot command. These plots should be examined for unusual behavior in the empirical  $f(x)$ , including holes or spikes in the tail. MCNP tries to assess both conditions and prints a message if either condition is found.

### ***I. Forming Statistically Valid Confidence Intervals***

The ultimate goal of a Monte Carlo calculation is to produce a valid confidence interval for each tally bin. Section VI has described different statistical quantities and the recommended criteria to form a valid confidence interval. Detailed descriptions of the information available in the output for all tally bins and the TFC bins are now discussed.

#### **1. Information Available for Forming Statistically Valid Confidence**

The R is calculated for every user-specified tally bin in the problem. The VOV and the shifted confidence interval center, discussed below, can be obtained for all bins with a nonzero entry for the 15th entry on the DBCN card at problem initiation.

a. R Magnitude Comparisons With MCNP Guidelines: The quality of MCNP Monte Carlo tallies historically has been associated with two statistical checks that have been the responsibility of the user: 1) for all tally bins, the estimated relative error magnitude rules-of-thumb that are shown in Fig. 2-3 (i.e.,  $R < 0.1$  for nonpoint detector tallies and  $R < 0.05$  for point detector tallies); and 2) a statistically constant FOM in the user-selectable (TFn card) TFC bin so that the estimated R is decreasing by  $1/\sqrt{N}$  as required by the CLT.

In an attempt to make the user more aware of the seriousness of checking these criteria, MCNP provides checks of the R magnitude for all tally bins. A summary of the checks is printed in the “Status of Statistical Checks” table. Messages are provided to the user giving the results of these checks.

b. Asymmetric Confidence Intervals: A correlation exists between the estimated mean and the estimated uncertainty in the mean.<sup>89</sup> If the estimated mean is below the expected value, the estimated uncertainty in the mean  $S_{\bar{x}}$  will most likely be below its expected value. This correlation is also true for higher moment quantities such as the VOV. The worst situation for forming valid confidence intervals is when the estimated mean is much smaller than the expected value, resulting in smaller than predicted coverage rates. To correct for this correlation and improve coverage rates, one can estimate a statistic shift in the midpoint of the confidence interval to a higher value. The estimated mean is unchanged.

## CHAPTER 2 ESTIMATION OF THE MONTE CARLO PRECISION

The shifted confidence interval midpoint is the estimated mean plus a term proportional to the third central moment. The term arises from an Edgeworth expansion<sup>89</sup> to attempt to correct the confidence interval for non-normality effects in the estimate of the mean. The adjustment term is given by

$$SHIFT = \Sigma(x_i - \bar{x})^3 / (2S^2N) \quad .$$

Substituting for the estimated mean and expanding produces

$$SHIFT = (\Sigma x_i^3 - 3\Sigma x_i^2 \Sigma x_i / N + 2(\Sigma x_i)^3 / N^2) / (2(N\Sigma x_i^2 - (\Sigma x_i)^2)) \quad .$$

The *SHIFT* should decrease as  $1/N$ . This term is added to the estimated mean to produce the midpoint of the now asymmetric confidence interval about the mean. This value of the confidence interval midpoint can be used to form the confidence interval about the estimated mean to improve coverage rates of the true, but unknown, mean  $E(x)$ . The estimated mean plus the *SHIFT* is printed automatically for the TFC bin for all tallies. A nonzero entry for the 15th DBCN card entry produces the shifted value for all tally bins.

This correction approaches zero as  $N$  approaches infinity, which is the condition required for the CLT to be valid. Kalos<sup>97</sup> uses a slightly modified form of this correction to determine if the requirements of the CLT are “substantially satisfied.” His relation is

$$\left| \Sigma(x_i - \bar{x})^3 \right| \ll S^3 \sqrt{N} \quad ,$$

which is equivalent to

$$SHIFT \ll S_{\bar{x}} / 2 \quad .$$

The user is responsible for applying this check.

c. Forming Valid Confidence Intervals for Non-TFC Bins: The amount of statistical information available for non-TFC bins is limited to the mean and R. The VOV and the center of the asymmetric confidence can be obtained for all tally bins with a nonzero 15th entry on the DBCN card in the initial problem. The magnitude criteria for R (and the VOV, if available) should be met before forming a confidence interval. If the shifted confidence interval center is available, it should be used to form asymmetric confidence intervals about the estimated mean.

History dependent information about R (and the VOV, if available) for non-TFC bins can be obtained by printing out the tallies periodically during a calculation using the PRDMP card. The  $N$ -dependent behavior of R can then be assessed. The complete statistical information available can be obtained by creating a new tally and selecting the desired tally bin with the TF $n$  card.

2. Information Available for Forming Statistically Valid Confidence Intervals for TFC Bins

Additional information about the statistical behavior of each TFC bin result is available. A TFC bin table is produced by MCNP after each tally to provide the user with detailed information about the apparent quality of the TFC bin result. The contents of the table are discussed in the following subsections, along with recommendations for forming valid confidence intervals using this information.

a. TFC Bin Tally Information: The first part of the TFC bin table contains information about the TFC bin result including the mean,  $R$ , scoring efficiency, the zero and nonzero history score components of  $R$  (see page 2-109), and the shifted confidence interval center. The two components of  $R$  can be used to improve the problem efficiency by either improving the history scoring efficiency or reducing the range of nonzero history scores.

b. The Largest TFC Bin History Score Occurs on the Next History: There are occasions when the user needs to make a conservative estimate of a tally result. Conservative is defined so that the results will not be less than the expected result. One reasonable way to make such an estimate is to assume that the largest observed history score would occur again on the very next history,  $N + 1$ .

MCNP calculates new estimated values for the mean,  $R$ , VOV, FOM, and shifted confidence interval center for the TFC bin result for this assumption. The results of this proposed occurrence are summarized in the TFC bin information table. The user can assess the impact of this hypothetical happening and act accordingly.

c. Description of the 10 Statistical Checks for the TFC Bin: MCNP prints the results of ten statistical checks of the tally in the TFC bin at each print. In a “Status of Statistical Checks” table, the results of these ten checks are summarized at the end of the output for all TFC bin tallies. The quantities involved in these checks are the estimated mean,  $R$ , VOV, FOM, and the large history score behavior of  $f(x)$ . Passing all of the checks should provide additional assurance that any confidence intervals formed for a TFC bin result will cover the expected result the correct fraction of the time. At a minimum, the results of these checks provide the user with more information about the statistical behavior of the result in the TFC bin of each tally.

The following 10 statistical checks are made on the TFCs printed at the end of the output for desirable statistical properties of Monte Carlo solutions:

MEAN

- (1) a nonmonotonic behavior (no up or down trend) in the estimated mean as a function of the number histories  $N$  for the last half of the problem;



## CHAPTER 2 ESTIMATION OF THE MONTE CARLO PRECISION

R

- (2) an acceptable magnitude of the estimated R of the estimated mean ( $< 0.05$  for a point detector tally or  $< 0.10$  for a non-point detector tally);
- (3) a monotonically decreasing R as a function of the number histories  $N$  for the last half of the problem;
- (4) a  $1/\sqrt{N}$  decrease in the R as a function of  $N$  for the last half of the problem;

VOV

- (5) the magnitude of the estimated VOV should be less than 0.10 for all types of tallies;
- (6) a monotonically decreasing VOV as a function of  $N$  for the last half of the problem;
- (7) a  $1/N$  decrease in the VOV as a function of  $N$  for the last half of the problem;

FOM

- (8) a statistically constant value of the FOM as a function of  $N$  for the last half of the problem;
- (9) a nonmonotonic behavior in the FOM as a function of  $N$  for the last half of the problem; and

$f(x)$

- (10) the SLOPE (see page 2–118) of the 25 to 201 largest positive (negative with a negative DBCN(16) entry) history scores  $x$  should be greater than 3.0 so that the second moment  $\int_{-\infty}^{\infty} x^2 f(x) dx$  will exist if the SLOPE is extrapolated to infinity.

The seven  $N$ -dependent checks for the TFC bin are for the last half of the problem. The last half of the problem should be well behaved in the sense of the CLT to form the most valid confidence intervals. “Monotonically decreasing” in checks 3 and 5 allows for some increases in both R and the VOV. Such increases in adjacent TFC entries are acceptable and usually do not, by themselves, cause poor confidence intervals. A TFC bin R that does not pass check 3, by definition in MCNP, does not pass check 4. Similarly, a TFC bin VOV that does not pass check 6, by definition, does not pass check 7.

A table is printed after each tally for the TFC bin result that summarizes the results and the pass or no-pass status of the checks. Both asymmetric and symmetric confidence intervals are printed for the one, two, and three  $\sigma$  levels when all of the statistical checks are passed. These intervals can be expected to be correct with improved probability over historical rules of thumb. This is NOT A GUARANTEE, however; there is always a possibility that some as-yet-unsampled portion of the problem would change the confidence interval if more histories were calculated.

## CHAPTER 2

### ESTIMATION OF THE MONTE CARLO PRECISION

A WARNING is printed if one or more of these ten statistical checks is not passed, and one page of printed plot information about  $f(x)$  is produced for the user to examine.

An additional information-only check is made on the largest five  $f(x)$  score grid bins to determine if there are bins that have no samples or if there is a spike in an  $f(x)$  that does not appear to have an upper limit. The result of the check is included in the TFC summary table for the user to consider. This check is not a pass or no-pass test because a hole in the tail may be appropriate for a discrete  $f(x)$  or an exceptional sample occurred with so little impact that none of the ten checks was affected. The empirical  $f(x)$  should be examined to assess the likelihood of “complete” sampling.

d. Forming Valid TFC Bin Confidence Intervals: For TFC bin results, the highest probability of creating a valid confidence interval occurs when all of the statistical checks are passed. Not passing several of the checks is an indication that the confidence interval is less likely to be correct. A monotonic trend in the mean for the last half of the problem is a strong indicator that the confidence interval is likely to produce incorrect coverage rates. The magnitudes of R and the VOV should be less than the recommended values to increase the likelihood of a valid confidence interval. Small jumps in the R, VOV, and/or the FOM as a function of  $N$  are not threatening to the quality of a result. The slope of  $f(x)$  is an especially strong indicator that  $N$  has not approached infinity in the sense of the CLT. If the slope appears too shallow ( $< 3$ ), check the printed plot of  $f(x)$  to see that the estimated Pareto fit is adequate. The use of the shifted confidence interval is recommended, although it will be a small effect for a well-converged problem.

The last half of the problem is determined from the TFC. The more information available about the last half of the problem, the better the  $N$ -dependent checks will be. Therefore, a problem that has run 40,000 histories will have 20 TFC  $N$  entries, which is more  $N$  entries than a 50,000 history problem with 13 entries. It is possible that a problem that passes all tests at 40,000 may not pass all the tests at 40,001. As is always the case, the user is responsible for deciding when a confidence interval is valid. These statistical diagnostics are designed to aid in making this decision.

#### ***J. A Statistically Pathological Output Example***

A statistically pathological test problem is discussed in this section. The problem calculates the surface neutron leakage flux above 12 MeV from an isotropic 14 MeV neutron point source of unit strength at the center of a 30 cm thick concrete shell with an outer radius of 390 cm. Point and ring detectors were deliberately used to estimate the surface neutron leakage flux with highly inefficient, long-tailed  $f(x)$ s. The input is shown on page 5–50.

The variance reduction methods used were implicit capture with weight cutoff, low-score point detector Russian roulette, and a 0.5 mean free path (4 cm) neighborhood around the detectors to

## CHAPTER 2

### ESTIMATION OF THE MONTE CARLO PRECISION

produce large, but finite, higher moments. Other tallies or variance reduction methods could be used to make this calculation much more efficient, but that is not the object of this example. A surface flux estimator would have been over a factor of 150 to 30,000 times more efficient than ring and point detectors, respectively.

Figure 2.16 shows MCNP plots of the estimated mean, R, VOV and slope of the history score PDF as a function of  $N$  values of 20,000 (left column) and 5 million (right column). The ring detector results are shown as the solid line and the point detector result is the dashed line.

Column 1 shows the results as a function of  $N$  for 20,000 histories. The point detector result at 14,000 histories (not shown) was  $1.41 \times 10^{-8} n/cm^2/s$  (R=0.041). The FOM varied somewhat randomly between about 800 and 1160 for the last half of the problem. With no other information, this result could be accepted by even a careful Monte Carlo practitioner. However, the VOV never gets close to the required 0.1 value and the slope of the unbounded  $f(x)$  is less than 1.4. This slope could not continue indefinitely because even the mean of  $f(x)$  would not exist. Therefore, a confidence interval should not be formed for this tally. At 20,000 histories, R increases substantially and the FOM crashes, indicating serious problems with the result.

The ring detector result is having problems of its own. The ring detector result for 14,000 histories was  $4.60 \times 10^{-8} n/cm^2/s$  (R=0.17, VOV=0.35, slope=2.1, FOM=67). None of the plotted quantities satisfies the required convergence criteria. The correct detector result, obtained from a 5 million history ring detector tally, is  $5.72 \times 10^{-8} n/cm^2/s$  (R=0.0169, VOV=0.023, slope=4.6, FOM=19). The apparently converged 14,000 history point detector result is a factor of four below the correct result!

If you were to run 200,000 histories, you would see the point detector result increasing to  $3.68 \times 10^{-8} n/cm^2/s$  (R=0.20, VOV=0.30, slope=1.6, FOM=1.8). The magnitudes of R and the VOV are much too large for the point detector result to be accepted. The slope of  $f(x)$  is slowly increasing, but has only reached a value of 1.6. This slope is still far too shallow compared to the required value of 3.0.

The ring detector result of  $5.06 \times 10^{-8} n/cm^2/s$  (R=0.0579, VOV=0.122, slope=2.8, FOM=22) at 192,000 histories is interesting. All of these values are close to being acceptable, but just miss the requirements. The ring detector result is more than two estimated standard deviations below the correct result.

Column 2 shows the results as a function of  $N$  for 5 million histories. The ring detector result of  $5.72 \times 10^{-8} n/cm^2/s$  (R=0.0169, VOV=0.023, slope=4.6, FOM=19) now appears very well behaved in all categories. This tally passed all 10 statistical checks. There appears to be no reason to question the validity of this tally. The point detector result is  $4.72 \times 10^{-8} n/cm^2/s$  (R=0.11, VOV=0.28, slope=2.1, FOM=0.45). The result is clearly improving, but does not meet the acceptable criteria for convergence. This tally did not pass 3 out 10 statistical checks.

## CHAPTER 2

### ESTIMATION OF THE MONTE CARLO PRECISION

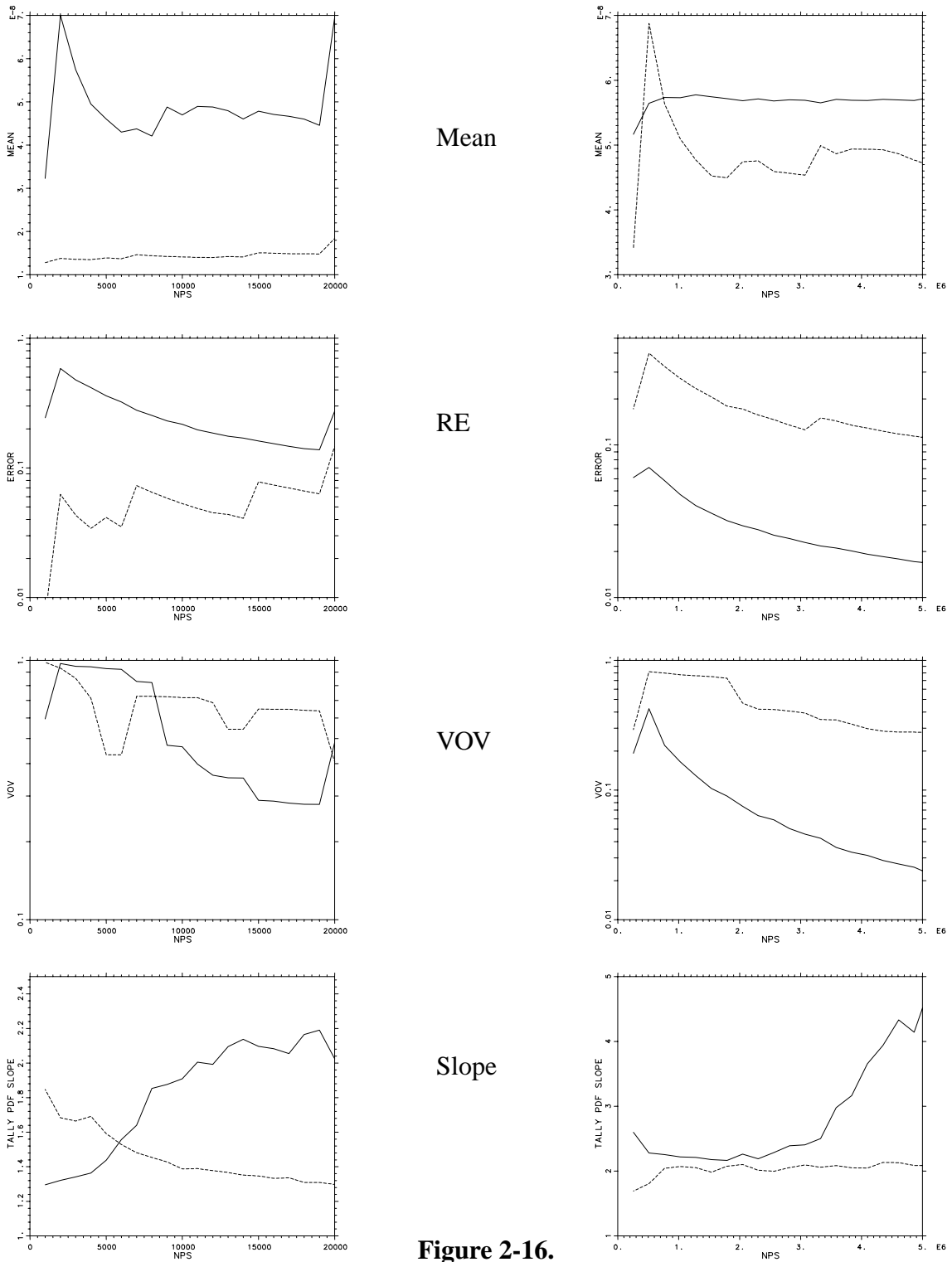

## CHAPTER 2

### ESTIMATION OF THE MONTE CARLO PRECISION

When you compare the empirical point detector  $f(x)$ s for 14,000 and 200 million histories you see that the 14,000 history  $f(x)$  clearly has unsampled regions in the tail, indicating incomplete  $f(x)$  sampling.<sup>94</sup> For the point detector, seven decades of  $x$  have been sampled by 200 million histories compared to only three decades for 14,000 histories. The largest  $x$ 's occur from the extremely difficult to sample histories that have multiple small energy loss collisions close to the detector. The 200 million history point detector result is  $5.41 \times 10^{-8} \text{ n/cm}^2/\text{s}$  ( $R=0.035$ ,  $VOV=0.60$ ,  $\text{slope}=2.4$ ,  $FOM=0.060$ ). The point detector  $f(x)$  slope is increasing, but still is not yet completely sampled. This tally did not pass 6 of 10 checks with 200 million histories. The result is about 1.5 estimated standard deviations below the correct answer. It is important to note that calculating a large number of histories DOES NOT guarantee a precise result. The more compact empirical ring  $f(x)$  for 20 million histories appears to be completely sampled because of the large slope. The results for 1 billion histories are shown in Ref. 86.

For difficult to sample problems such as this example, it is possible that an even larger history score could occur that would cause the VOV and possibly the slope to have unacceptable values. The mean and RE will be much less affected than the VOV. The additional running time required to reach acceptable values for the VOV and the slope could be prohibitive. The large history score should NEVER be discarded from the tally result. It is important that the cause for the large history score be completely understood. If the score was created by a poorly sampled region of phase space, the problem should be modified to provide improved phase space sampling. It is also possible that the large score was created by an extremely unlikely set of circumstances that occurred "early" in the calculation. In this situation, if the RE is within the guidelines, the empirical  $f(x)$  appears to be otherwise completely sampled, and the largest history score appears to be a once in a lifetime occurrence, a good confidence interval can still be formed. If a conservative (large) answer is required, the printed result that assumes the largest history score occurs on the very next history can be used.

Comparing several empirical  $f(x)$ s for the above problem with 200 million histories that have been normalized so that the mean of each  $f(x)$  is unity, you see that the point detector at 390 cm clearly is quite Cauchy-like (see Eq. (2.25) for many decades.<sup>93</sup> The point detector at 4000 cm is a much easier tally (by a factor of 10,000) as exhibited by the much more compact empirical  $f(x)$ . The large-score tail decreases in a manner similar to the negative exponential  $f(x)$ . The surface flux estimator is the most compact  $f(x)$  of all. The blip on the high-score tail is caused by the average cosine approximation of 0.05 between cosines of 0 and 0.1 (see page 2-80). This tally is 30,000 times more efficient than the point detector tally.

## **VII. VARIANCE REDUCTION**

### **A. General Considerations**

#### 1. Variance Reduction and Accuracy

Variance-reducing techniques in Monte Carlo calculations reduce the computer time required to obtain results of sufficient precision. Note that precision is only one requirement for a good Monte Carlo calculation. Even a zero variance calculation cannot accurately predict natural behavior if other sources of error are not minimized. Factors affecting accuracy were discussed in Section VI beginning on page 2-99.

#### 2. Two Choices That Affect Efficiency

The efficiency of a Monte Carlo calculation is affected by two choices, tally type and random walk sampling. The tally choice (for example, point detector flux tally vs. surface crossing flux tally) amounts to trying to obtain the best results from the random walks sampled. The chosen random walk sampling amounts to preferentially sampling “important” random walks at the expense of “unimportant” random walks. (A random walk is important if it has a large affect on a tally.) These two choices usually affect the time per history and the history variance as described in Sec. 3 below. MCNP estimates tallies of the form

$$\langle T \rangle = \int d\vec{r} \int d\vec{v} \int dt N(\vec{r}, \vec{v}, t) T(\vec{r}, \vec{v}, t)$$

by sampling particle histories that statistically produce the correct particle density  $N(\vec{r}, \vec{v}, t)$ . The tally function  $T(\vec{r}, \vec{v}, t)$  is zero except where a tally is required. For example, for a surface crossing tally (*FI*),  $T$  will be one on the surface and zero elsewhere. MCNP variance reduction techniques allow the user to try to produce better statistical estimates of  $N$  where  $T$  is large, usually at the expense of poorer estimates where  $T$  is zero or small.

There are many ways to statistically produce  $N(\vec{r}, \vec{v}, t)$ . Analog Monte Carlo simply samples the events according to their natural physical probabilities. In this way, an analog Monte Carlo calculation estimates the number of physical particles executing any given random walk. Nonanalog techniques do not directly simulate nature. Instead, nonanalog techniques are free to do anything if  $N$ , hence  $\langle T \rangle$ , is preserved. This preservation is accomplished by adjusting the weight of the particles. The weight can be thought of as the number of physical particles represented by the MCNP particle (see page 2-26). Every time a decision is made, the nonanalog techniques require that the expected weight associated with each outcome be the same as in the analog game. In this way, the expected number of physical particles executing any given random walk is the same as in the analog game.

## CHAPTER 2 VARIANCE REDUCTION

For example, if an outcome “A” is made  $q$  times as likely as in the analog game, when a particle chooses outcome “A,” its weight must be multiplied by  $q^{-1}$  to preserve the expected weight for outcome “A.” Let  $p$  be the analog probability for outcome “A”; then  $pq$  is the nonanalog probability for outcome “A.” If  $w_0$  is the current weight of the particle, then the expected weight for outcome “A” in the analog game is  $w_0 * p$  and the expected weight for outcome “A” in the nonanalog game is  $(w_0/q) * pq$ .

MCNP uses three basic types of nonanalog games: (1) splitting, (2) Russian roulette, and (3) sampling from nonanalog probability density functions. The previous paragraph discusses type 3. Splitting refers to dividing the particle's weight among two or more daughter particles and following the daughter particles independently. Usually the weight is simply divided evenly among  $k$  identical daughter particles whose characteristics are identical to the parent except for a factor  $1/k$  in weight (for example, splitting in the weight window). In this case the expected weight is clearly conserved because the analog technique has one particle of weight  $w_0$  at  $(\vec{r}, \vec{v}, t)$ , whereas the splitting results in  $k$  particles of weight  $w_0/k$  at  $(\vec{r}, \vec{v}, t)$ . In both cases the outcome is weight  $w_0$  at  $(\vec{r}, \vec{v}, t)$ .

Other splitting techniques split the parent particle into  $k$ , typically two, differing daughter particles. The weight of the  $j^{\text{th}}$  daughter represents the expected number of physical particles that would select outcome  $j$  from a set of  $k$  mutually exclusive outcomes. For example, the MCNP forced collision technique considers two outcomes: (1) the particle reaches a cell boundary before collision, or (2) the particle collides before reaching a cell boundary. The forced collision technique divides the parent particle representing  $w_0$  physical particles into two daughter particles, representing  $w_1$  physical particles that are uncollided and  $w_2$  physical particles that collide. The uncollided particle of weight  $w_1$  is then put on the cell boundary. The collision site of the collided particle of weight  $w_2$  is selected from a conditional distance-to-collision probability density, the condition being that the particle must collide in the cell. This technique preserves the expected weight colliding at any point in the cell as well as the expected weight not colliding. A little simple mathematics is required to demonstrate this technique.

Russian roulette takes a particle at  $(\vec{r}, \vec{v}, t)$  of weight  $w_0$  and turns it into a particle of weight  $w_1 > w_0$  with probability  $w_0/w_1$  and kills it (that is, weight=0) with probability  $(1 - (w_0/w_1))$ . The expected weight at  $(\vec{r}, \vec{v}, t)$  is  $w_1 * (w_0/w_1) + (1 - (w_0/w_1)) * 0 = w_0$ , the same as in the analog game.

Some techniques use a combination of these basic games and DXTRAN uses all three.

### 3. Efficiency, Time per History, and History Variance

Recall from page 2–108 that the measure of efficiency for MCNP calculations is the *FOM*:  $FOM \equiv 1/(R^2 T)$ , where

$R^2$  = sample relative standard deviation of the mean and  
 $T$  = computer time for the calculation (in minutes).

Recall from Eqns. 2.17 and 2.19a that  $R = (S/\sqrt{N})/\bar{x}$ , where

$S^2$  = sample history variance,  
 $N$  = number of particles, and  
 $\bar{x}$  = sample mean.

Generally we are interested in obtaining the smallest  $R$  in a given time  $T$ . The equation above indicates that to decrease  $R$  it is desirable to: 1) decrease  $S$  and 2) increase  $N$ ; that is, decrease the time per particle history. Unfortunately, these two goals usually conflict. Decreasing  $S$  normally requires more time because better information is required. Increasing  $N$  normally increases  $S$  because there is less time per history to obtain information. However, the situation is not hopeless. It is often possible either to decrease  $S$  substantially without decreasing  $N$  too much or to increase  $N$  substantially without increasing  $S$  too much, so that  $R$  decreases.

Many variance reduction techniques in MCNP attempt to decrease  $R$  by either producing or destroying particles. Some techniques do both. In general, techniques that produce tracks work by decreasing  $S$  (we hope much faster than  $N$  decreases) and techniques that destroy tracks work by increasing  $N$  (we hope much faster than  $S$  increases).

#### 4. Strategy

Successful use of MCNP variance reduction techniques is often difficult, tending to be more art than science. The introduction of the weight window generator has improved things, but the user is still fundamentally responsible for the choice and proper use of variance reducing techniques. Each variance reduction technique has its own advantages, problems, and peculiarities. However, there are some general principles to keep in mind while developing a variance reduction strategy.

Not surprisingly, the general principles all have to do with understanding both the physical problem and the variance reduction techniques available to solve the problem. If an analog calculation will not suffice to calculate the tally, there must be something special about the particles that tally. The user should understand the special nature of those particles that tally. Perhaps, for example, only particles that scatter in particular directions can tally. After the user understands why the tallying particles are special, MCNP techniques can be selected (or developed by the user) that will increase the number of special particles followed.

After the MCNP techniques are selected the user typically has to supply appropriate parameters to the variance reduction techniques. This is probably more difficult than is the selection of



## CHAPTER 2

### VARIANCE REDUCTION

techniques. The first guess at appropriate parameters typically comes either from experience with similar problems or from experience with an analog calculation of the current problem. It is usually better to err on the conservative side; that is, too little biasing rather than too much biasing. After the user has supplied parameters for the variance reduction techniques, a short Monte Carlo run is done so that the effectiveness of the techniques and parameters can be monitored with the MCNP output.

The MCNP output contains much information to help the user understand the sampling. This information should be examined to ensure that

- (1) the variance reduction techniques are improving the sampling of the particles that tally;
- (2) the variance reduction techniques are working cooperatively; that is, one is not destructively interfering with another;
- (3) the *FOM* table is not erratic, which would indicate poor sampling; and
- (4) there is nothing that looks obviously ridiculous.

Unfortunately, analyzing the output information requires considerable thought and experience. Reference 98 shows in detail strategies and analysis for a particular problem.

After ascertaining that the techniques are improving the calculation, the user makes a few more short runs to refine the parameters until the sampling no longer improves. The weight window generator can also be turned on to supply information about the importance function in different regions of the phase space. This rather complex subject is described on page 2–139.

#### 5. Erratic Error Estimates

Erratic error estimates are sometimes observed in MCNP calculations. In fact, the primary reason for the Tally Fluctuation Chart (TFC) table in the MCNP output is to allow the user to monitor the *FOM* and the relative error as a function of the number of histories. With few exceptions, such as an analog point detector embedded in a scattering medium with  $R_o = 0$  (a practice highly discouraged), MCNP tallies are finite variance tallies. For finite variance tallies the relative error should decrease roughly as  $\sqrt{N}$  so the *FOM* should be roughly constant and the ten statistical checks of the tallies (see page 2–121) should all be passed. If the statistical checks are not passed, the error estimates should be considered erratic and unreliable, no matter how small the relative error estimate is.

Erratic error estimates occur typically because a high-weight particle tallies from an important region of phase space that has not been well sampled. A high-weight particle in a given region of phase space is a particle whose weight is some nontrivial fraction of  $\overline{\text{all}}$  the weight that has tallied from that region because of all previous histories. A good example is a particle that collides very close to a point or ring detector. If not much particle weight has previously

collided that close to the detector, the relative error estimate will exhibit a jump for that history. Another example is coherent photon scattering towards a point detector (see page 2–62).

To avoid high-weight particles in important regions, the user should try to ensure that these regions are well sampled by many particles and try to minimize the weight fluctuation among these particles. Thus the user should try to use biasing techniques that preferentially push particles into important regions without introducing large weight fluctuations in these regions. The weight window can often be very useful in minimizing weight fluctuations caused by other variance reduction techniques.

If, despite a user's efforts, an erratic error estimate occurs, the user should obtain event logs for those particles causing the estimate to be erratic. The event logs should be studied to learn what is special about these particles. When the special nature of these particles is understood, the user can adjust the variance reduction techniques to sample these particles more often. Thus their weight will be smaller and they will not be as likely to cause erratic estimates. *Under absolutely no circumstances should these particles be discarded or ignored!* The fact that these particles contribute very heavily to the tally indicates that they are important to the calculation and the user should try to sample more of them.

#### 6. Biasing Against Random Walks of Presumed Low Importance

It was mentioned earlier that one should be cautious and conservative when applying variance reduction techniques. Many more people get into trouble by overbiasing than by underbiasing. Note that preferentially sampling some random walks means that some walks will be sampled (for a given computer time) less frequently than they would have been in an analog calculation. Sometimes these random walks are so heavily biased against that very few, or even none, are ever sampled in an actual calculation because not enough particles are run.

Suppose that (on average) for every million histories only one track enters cell 23. Further suppose that a typical run is 100,000 histories. On any given run it is unlikely that a track enters cell~23. Now suppose that tracks entering cell 23 turn out to be much more important than a user thought. Maybe 10% of the answer should come from tracks entering cell 23. The user could run 100,000 particles and get 90% of the true tally with an estimated error of 1%, with absolutely no indication that anything is amiss. However, suppose the biasing had been set such that (on average) for every 10,000 particles, one track entered cell 23, about 10 tracks total. The tally probably will be severely affected by at least one high weight particle and will hover closer to the true tally with a larger and perhaps erratic error estimate. The essential point is this: following ten tracks into cell 23 does not cost much computer time and it helps ensure that the estimated error cannot be low when the tally is seriously in error. Always make sure that all regions of the problem are sampled enough to be certain that they are unimportant.

## CHAPTER 2 VARIANCE REDUCTION

### *B. Variance Reduction Techniques*

There are four classes of variance reduction techniques<sup>99</sup> that range from the trivial to the esoteric.

*Truncation Methods* are the simplest of variance reduction methods. They speed up calculations by truncating parts of phase space that do not contribute significantly to the solution. The simplest example is geometry truncation in which unimportant parts of the geometry are simply not modeled. Specific truncation methods available in MCNP are energy cutoff and time cutoff.

*Population Control Methods* use particle splitting and Russian roulette to control the number of samples taken in various regions of phase space. In important regions many samples of low weight are tracked, while in unimportant regions few samples of high weight are tracked. A weight adjustment is made to ensure that the problem solution remains unbiased. Specific population control methods available in MCNP are geometry splitting and Russian roulette, energy splitting/roulette, weight cutoff, and weight windows.

*Modified Sampling Methods* alter the statistical sampling of a problem to increase the number of tallies per particle. For any Monte Carlo event it is possible to sample from any arbitrary distribution rather than the physical probability as long as the particle weights are then adjusted to compensate. Thus with modified sampling methods, sampling is done from distributions that send particles in desired directions or into other desired regions of phase space such as time or energy, or change the location or type of collisions. Modified sampling methods in MCNP include the exponential transform, implicit capture, forced collisions, source biasing, and neutron-induced photon production biasing.

*Partially-Deterministic Methods* are the most complicated class of variance reduction methods. They circumvent the normal random walk process by using deterministic-like techniques, such as next event estimators, or by controlling of the random number sequence. In MCNP these methods include point detectors, DXTRAN, and correlated sampling.

The available MCNP variance reduction techniques now are described.

#### 1. Energy Cutoff

The energy cutoff in MCNP is either a single user-supplied, problem-wide energy level or a cell-dependent energy level. Particles are terminated when their energy falls below the energy cutoff. The energy cutoff terminates tracks and thus decreases the time per history. The energy cutoff should be used only when it is known that low-energy particles are either of zero or almost zero importance. An energy cutoff is like a Russian roulette game with zero survival probability. A number of pitfalls exist.

1. Remember that low-energy particles can often produce high-energy particles (for example, fission or low-energy neutrons inducing high-energy photons). Thus, even if a detector is not sensitive to low-energy particles, the low-energy particles may be important to the tally.
2. The CUT card energy cutoff is the same throughout the entire problem. Often low-energy particles have zero importance in some regions and high importance in others, and so a cell-dependent energy cutoff is also available with the ELPT card.
3. The answer will be biased (low) if the energy cutoff is killing particles that might otherwise have contributed. Furthermore, as  $N \rightarrow \infty$  the apparent error will go to zero and therefore mislead the unwary. Serious consideration should be given to two techniques discussed later, energy roulette and space-energy weight window, that are always unbiased.

The energy cutoff has one advantage not directly related to variance reduction. A lower energy cutoff requires more cross sections so that computer memory requirements go up and interactive computing with a timesharing system is degraded.

## 2. Time Cutoff

The time cutoff in MCNP is a single user-supplied, problem-wide time value. Particles are terminated when their time exceeds the time cutoff. The time cutoff terminates tracks and thus decreases the computer time per history. A time cutoff is like a Russian roulette game with zero survival probability. The time cutoff should only be used in time-dependent problems where the last time bin will be earlier than the cutoff.

Although the energy and time cutoffs are similar, more caution must be exercised with the energy cutoff because low energy particles can produce high energy particles, whereas a late time particle cannot produce an early time particle.

## 3. Geometry Splitting with Russian Roulette

Geometry splitting/Russian roulette is one of the oldest and most widely used variance-reducing techniques in Monte Carlo codes. When used judiciously, it can save substantial computer time. As particles migrate in an important direction, they are increased in number to provide better sampling, but if they head in an unimportant direction, they are killed in an unbiased manner to avoid wasting time on them. Oversplitting, however, can substantially waste computer time. Splitting generally decreases the history variance but increases the time per history, whereas Russian roulette generally increases the history variance but decreases the time per history.

Each cell in the problem geometry setup is assigned an importance  $I$  by the user on the IMP input card. The number  $I$  should be proportional to the estimated value that particles in the cell have for the quantity being scored. When a particle of weight  $W$  passes from a cell of importance  $I$  to

## CHAPTER 2

### VARIANCE REDUCTION

one of higher importance  $I'$ , the particle is split into a number of identical particles of lower weight according to the following recipe. If  $I'/I$  is an integer  $n$  ( $n \geq 2$ ), the particle is split into  $n$  identical particles, each weighing  $W/n$ . Weight is preserved in the integer splitting process. If  $I'/I$  is not an integer but still greater than 1, splitting is done probabilistically so that the expected number of splits is equal to the importance ratio. Denoting  $n = [I'/I]$  to be the largest integer in  $I'/I$ ,  $p = I'/I - n$  is defined. Then with probability  $p$ ,  $n + 1$  particles are used, and with probability  $1 - p$ ,  $n$  particles are used. For example, if  $I'/I$  is 2.75, 75% of the time split 3 for 1 and 25% of the time split 2 for 1. The weight assigned to each particle is  $W \cdot I/I'$ , which is the expected weight, to minimize dispersion of weights.

On the other hand, if a particle of weight  $W$  passes from a cell of importance  $I$  to one of lower importance  $I'$ , so that  $I'/I < 1$ , Russian roulette is played and the particle is killed with probability  $1 - (I'/I)$ , or followed further with probability  $I'/I$  and weight  $W \cdot I/I'$ .

Geometry splitting with Russian roulette is very reliable. It can be shown that the weights of all particle tracks are the same in a cell no matter which geometrical path the tracks have taken to get to the cell, assuming that no other biasing techniques, e.g. implicit capture, are used. The variance of any tally is reduced when the possible contributors all have the same weight.

The assigned cell importances can have any value—they are not limited to integers. However, adjacent cells with greatly different importances place a greater burden on reliable sampling. Once a sample track population has deteriorated and lost some of its information, large splitting ratios (like 20 to 1) can build the population back up, but nothing can regain the lost information. It is generally better to keep the ratio of adjacent importances small (for example, a factor of a few) and have cells with optical thicknesses in the penetration direction less than about two mean free paths. MCNP prints a warning message if adjacent importances or weight windows have a ratio greater than 4. PRINT TABLE 120 in the OUTP file lists the affected cells and ratios.

Generally, in a deep penetration shielding problem the sample size (number of particles) diminishes to almost nothing in an analog simulation, but splitting helps keep the size built up. A good rule is to keep the population of tracks traveling in the desired direction more or less constant—that is, approximately equal to the number of particles started from the source. A good initial approach is to split the particles 2 for 1 wherever the track population drops by a factor of 2. Near-optimum splitting usually can be achieved with only a few iterations and additional iterations show strongly diminishing returns. Note that in a combined neutron/photon problem, importances will probably have to be set individually for neutrons and for photons.

MCNP never splits into a void, although Russian roulette can be played entering a void. Splitting into a void accomplishes nothing except extra tracking because all the split particles must be tracked across the void and they all make it to the next surface. The split should be done according to the importance ratio of the last nonvoid cell departed and the first nonvoid cell entered. Note four more items:

1. Geometry splitting/Russian roulette works well only in problems that do not have extreme angular dependence. In the extreme case, splitting/Russian roulette can be useless if no particles ever enter an important cell where the particles can be split.
2. Geometry splitting/Russian roulette will preserve weight variations. The technique is “dumb” in that it never looks at the particle weight before deciding appropriate action. An example is geometry splitting/Russian roulette used with source biasing.
3. Geometry splitting/Russian roulette are turned on or off together.
4. Particles are killed immediately upon entering a zero importance cell, acting as a geometry cutoff.

#### 4. Energy Splitting/Roulette

Energy splitting and roulette typically are used together, but the user can specify only one if desired. Energy splitting/roulette is independent of spatial cell. If the problem has a space-energy dependence, the space-energy dependent weight window is normally a better choice.

1. Splitting: In some cases, particles are more important in some energy ranges than in others. For example, it may be difficult to calculate the number of  $^{235}\text{U}$  fissions because the thermal neutrons are also being captured and not enough thermal neutrons are available for a reliable sample. In this case, once a neutron falls below a certain energy level it can be split into several neutrons with an appropriate weight adjustment. A second example involves the effect of fluorescent emission after photoelectric absorption. With energy splitting, the low-energy photon track population can be built up rather than rapidly depleted, as would occur naturally with the high photoelectric absorption cross section. Particles can be split as they move up or down in energy at up to five different energy levels.

Energy splitting can increase as well as decrease tally variances. Currently, the MCNP weight cutoff game does not take into account whether a particle has undergone energy splitting or not. Consequently, particles undergoing energy splitting may then be rouletted by the weight cutoff game, defeating any advantages of the energy splitting.

With only a minor modification to MCNP, the mechanics for energy splitting can be used for time splitting.

2. Russian roulette: In many cases the number of tracks increases with decreasing energy, especially neutrons near the thermal energy range. These tracks can have many collisions requiring appreciable computer time. They may be important to the problem and cannot be completely eliminated with an energy cutoff, but their number can be reduced by playing a Russian roulette game to reduce their number and computer time.

## CHAPTER 2 VARIANCE REDUCTION

If a track's energy drops through a prescribed energy level, the roulette game is played, based on the input value of the survival probability. If the game is won, the track's history is continued, but its weight is increased by the reciprocal of the survival probability to conserve weight.

### 5. Weight Cutoff

In weight cutoff, Russian roulette is played if a particle's weight drops below a user-specified weight cutoff. The particle is either killed or its weight is increased to a user-specified level. The weight cutoff was originally envisioned for use with geometry splitting/Russian roulette and implicit capture, see page 2–144. Because of this intent,

1. The weight cutoffs in cell  $j$  depend not only on  $WC1$  and  $WC2$  on the CUT card, but also on the cell importances.
2. Implicit capture is always turned on (except in detailed photon physics) whenever a nonzero  $WC1$  is specified.

Referring to item 1 above, the weight cutoff is applied when the particle's weight falls below  $R_j * WC2$ , where  $R_j$  is the ratio of the source cell importance (IMP card) to cell  $j$ 's importance. With probability  $W/(WC1 * R_j)$  the particle survives with new weight  $WC1 * R_j$ ; otherwise the particle is killed. When  $WC1$  and  $WC2$  on the CUT card are negative, the weight cutoff is scaled to the minimum source weight of a particle so that source particles are not immediately killed by falling below the cutoff.

As mentioned earlier, the weight cutoff game was originally envisioned for use with geometry splitting and implicit capture. To illustrate the need for a weight cutoff when using implicit capture, consider what can happen without a weight cutoff. Suppose a particle is in the interior of a very large medium and there are neither time nor energy cutoffs. The particle will go from collision to collision, losing a fraction of its weight at each collision. Without a weight cutoff, a particle's weight would eventually be too small to be representable in the computer, at which time an error would occur. If there are other loss mechanisms (for example, escape, time cutoff, or energy cutoff), the particle's weight will not decrease indefinitely, but the particle may take an unduly long time to terminate.

Weight cutoff's dependence on the importance ratio can be easily understood if one remembers that the weight cutoff game was originally designed to solve the low-weight problem sometimes produced by implicit capture. In a high-importance region, the weights are low by design, so it makes no sense to play the same weight cutoff game in high- and low-importance regions.

Comments: Many techniques in MCNP cause weight change. The weight cutoff was really designed with geometry splitting and implicit capture in mind. Care should be taken in the use of other techniques.

Weight cutoff games are unlike time and energy cutoffs. In time and energy cutoffs, the random walk is always terminated when the threshold is crossed. Potential bias may result if the particle's importance was not zero. A weight cutoff (weight roulette would be a better name) does not bias the game because the weight is increased for those particles that survive.

Setting the weight cutoff is not typically an easy task and requires thought and experimentation. Essentially the user must guess what weight is worth following and start experimenting with weight cutoffs in that vicinity.

**6. Weight Window**

The weight window (Fig. 2-17) is a space-energy-dependent splitting and Russian roulette technique. For each space-energy phase space cell, the user supplies a lower weight bound. The upper weight bound is a user-specified multiple of the lower weight bound. These weight bounds define a window of acceptable weights. If a particle is below the lower weight bound, Russian roulette is played and the particle's weight is either increased to a value within the window or the particle is terminated. If a particle is above the upper weight bound, it is split so that all the split particles are within the window. No action is taken for particles within the window.

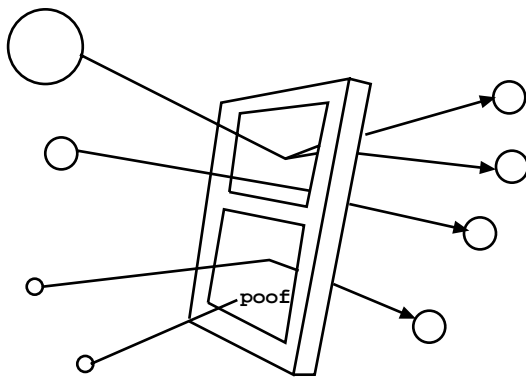

**Figure 2-17.**

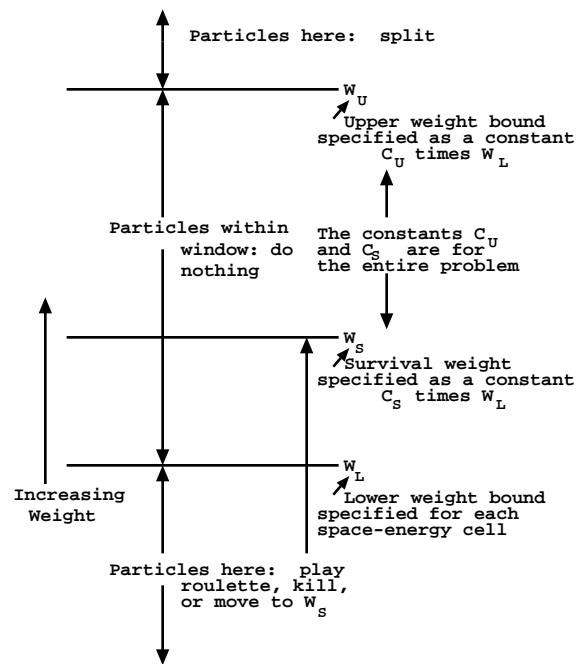

**Figure 2-18.**

Figure 2.18 is a more detailed picture of the weight window. Three important weights define the weight window in a space-energy cell



## CHAPTER 2

### VARIANCE REDUCTION

1.  $W_L$ , the lower weight bound,
2.  $W_S$ , the survival weight for particles playing roulette, and
3.  $W_U$ , the upper weight bound.

The user specifies  $W_L$  for each space-energy cell on WWN cards.  $W_S$  and  $W_U$  are calculated using two problem-wide constants,  $C_S$  and  $C_U$  (entries on the WWP card), as  $W_S = C_S W_L$  and  $W_U = C_U W_L$ . Thus all cells have an upper weight bound  $C_U$  times the lower weight bound and a survival weight  $C_S$  times the lower weight bound.

Although the weight window can be effective when used alone, it was designed for use with other biasing techniques that introduce a large variation in particle weight. In particular, a particle may have several “unpreferred” samplings, each of which will cause the particle weight to be multiplied by a weight factor substantially larger than one. Any of these weight multiplications by itself is usually not serious, but the cumulative weight multiplications can seriously degrade calculational efficiency. Worse, the error estimates may be misleading until enough extremely high-weight particles have been sampled. Monte Carlo novices are prone to be misled because they do not have enough experience reading and interpreting the summary information on the sampling supplied by MCNP. Hence, a novice may put more faith in an answer than is justified.

Although it is impossible to eliminate all pathologies in Monte Carlo calculations, a properly specified weight window goes far toward eliminating the pathology referred to in the preceding paragraph. As soon as the weight gets above the weight window, the particle is split and subsequent weight multiplications will thus be multiplying only a fraction of the particle’s weight (before splitting). Thus, it is hard for the tally to be severely perturbed by a particle of extremely large weight. In addition, low-weight particles are rouletted, so time is not wasted following particles of trivial weight.

One cannot ensure that every history contributes the same score (a zero variance solution), but by using a window inversely proportional to the importance, one can ensure that the mean score from any track in the problem is roughly constant. (A weight window generator exists to estimate these importance reciprocals; see page 2–139.) In other words, the window is chosen so that the track weight times the mean score (for unit track weight) is approximately constant. Under these conditions, the variance is due mostly to the variation in the number of contributing tracks rather than the variation in track score.

Thus far, two things remain unspecified about the weight window: the constant of inverse proportionality and the width of the window. It has been observed empirically that an upper weight bound five times the lower weight bound works well, but the results are reasonably insensitive to this choice anyway. The constant of inverse proportionality is chosen so that the

lower weight bound in some reference cell is chosen appropriately. In most instances the constant should be chosen so that the source particles start within the window.

1. Weight Window Compared to Geometry Splitting: Although both techniques use splitting and Russian roulette, there are some important differences.
  - a. The weight window is space-energy dependent. Geometry splitting is only space dependent.
  - b. The weight window discriminates on particle weight before deciding appropriate action. Geometry splitting is done regardless of particle weight.
  - c. The weight window works with absolute weight bounds. Geometry splitting is done on the ratio of the importance across a surface.
  - d. The weight window can be applied at surfaces, collision sites, or both. Geometry splitting is applied only at surfaces.
  - e. The weight window can control weight fluctuations introduced by other biasing techniques by requiring all particles in a cell to have weight  $W_L < W < W_U$ . The geometry splitting will preserve any weight fluctuations because it is weight independent.
  - f. In the rare case where no other weight modification schemes are present, importances will cause all particles in a given cell to have the same weight. Weight windows will merely bound the weight.
  - g. The weight windows can be turned off for a given cell or energy regime by specifying a zero lower bound. This is useful in long or large regions where no single importance function applies. Care should be used because when the weight window is turned off at collisions, the weight cutoff game is turned on, sometimes causing too many particles to be killed.
2. The Weight Window Generator: The generator is a method that automatically generates weight window importance functions.<sup>100</sup> The task of choosing importances by guessing, intuition, experience, or trial and error is simplified and insight into the Monte Carlo calculation is provided.

Although the window generator has proved very useful, two caveats are appropriate. The generator is by no means a panacea for all importance sampling problems and certainly is not a substitute for thinking on the user's part. In fact, in most instances, the user will have to decide when the generator's results look reasonable and when they do not. After these disclaimers, one might wonder what use to make of a

## CHAPTER 2 VARIANCE REDUCTION

generator that produces both good and bad results. To use the generator effectively, it is necessary to remember that the generated parameters are only statistical estimates and that these estimates can be subject to considerable error. Nonetheless, practical experience indicates that a user can learn to use the generator effectively to solve some very difficult transport problems.

Examples of the weight window generator are given in Ref. 98 and Ref. 100 and should be examined before using the generator. Note that this importance estimation scheme works regardless of what other variance reduction techniques are used in a calculation.

3. Theory: The importance of a particle at a point  $P$  in phase space equals the expected score a unit weight particle will generate. Imagine dividing the phase space into a number of phase space “cells” or regions. The importance of a cell then can be defined as the expected score generated by a unit weight particle after entering the cell. Thus, with a little bookkeeping, the cell’s importance can be estimated as

$$\text{Importance (expected score)} = \frac{\text{total score because of particles (and their progeny) entering the cell}}{\text{total weight entering the cell}}$$

After the importances have been generated, MCNP assigns weight windows inversely proportional to the importances. Then MCNP supplies the weight windows in an output file suitable for use as an input file in a subsequent calculation. The spatial portion of the phase space is divided using either standard MCNP cells or a superimposed mesh grid, which can be either rectangular or cylindrical. The energy portion of the phase space is divided using the WWGE card. The time portion of the phase space can be divided also. The constant of proportionality is specified on the WWG card.

4. Limitations of the Weight-Window Generator: The principal problem encountered when using the generator is bad estimates of the importance function because of the statistical nature of the generator. In particular, unless a phase space region is sampled adequately, there will be either no generator importance estimate or an unreliable one. The generator often needs a very crude importance guess just to get any tally; that is, the generator needs an initial importance function to estimate a (we hope) better one for subsequent calculations.

Fortunately, in most problems the user can guess some crude importance function sufficient to get enough tallies for the generator to estimate a new set of weight windows. Because the weight windows are statistical, several iterations usually are

required before the optimum importance function is found for a given tally. The first set of generated weight windows should be used in a subsequent calculation, which generates a better set of windows, etc.

In addition to iterating on the generated weight windows, the user must exercise some degree of judgment. Specifically, in a typical generator calculation, some generated windows will look suspicious and will have to be reset. In MCNP, this task is simplified by an algorithm that automatically scrutinizes cell-based importance functions, either input by the user or generated by a generator. By flagging the generated windows that are more than a factor of 4 different from those in adjacent spatial regions, often it is easy to determine which generated weight windows are likely to be statistical flukes that should be revised before the next generator iteration. For example, suppose the lower weight bounds in adjacent cells were 0.5, 0.3, 0.9, 0.05, 0.03, 0.02, etc.; here the user would probably want to change the 0.9 to something like 0.1 to fit the pattern, reducing the 18:1 ratio between cells 3 and 4.

The weight window generator also will fail when phase space is not sufficiently subdivided and no single set of weight window bounds is representative of the whole region. It is necessary to turn off the weight windows (by setting a lower bound of zero) or to further subdivide the geometry or energy phase space. Use of a superimposed importance mesh grid for weight window generation is a good way to subdivide the spatial portion of the phase space without complicating the MCNP cell geometry.

On the other hand, the weight window generator will also fail if the phase space is too finely subdivided and subdivisions are not adequately sampled. Adequate sampling of the important regions of phase space is always key to accurate Monte Carlo calculations and the weight window generator is a tool to help the user determine the important phase space regions. When using the mesh-based weight window generator, resist the temptation to create mesh cells that are too small.

## 7. Exponential Transform

The exponential transform samples the distance to collision from a nonanalog probability density function. Although many impressive results are claimed for the exponential transform, it should be remembered that these results are usually obtained for one-dimensional geometries and quite often for energy-independent problems. A review article by Clark<sup>101</sup> gives theoretical background and sample results for the exponential transform. Sarkar and Prasad<sup>102</sup> have done a purely analytical analysis for the optimum transform parameter for an infinite slab and one energy group. The exponential transform allows particle walks to move in a preferred direction by artificially reducing the macroscopic cross section in the preferred direction and increasing the cross section in the opposite direction according to

**CHAPTER 2**  
**VARIANCE REDUCTION**

$$\Sigma_t^* = \Sigma_t(1 - p\mu) \quad ,$$

where  $\Sigma_t^*$  = fictitious transformed cross section,  
 $\Sigma_t$  = true total cross section,  
 $\Sigma_a$  = absorption cross section,  
 $\Sigma_s$  = scattering cross section,  
 $p$  = the exponential transform parameter used to vary the degree of biasing  $|p| < 1$ . Can be a constant or  $p = \Sigma_a/\Sigma_t$ , in which case  $\Sigma_t^* = \Sigma_s$ , and  
 $\mu$  = cosine of the angle between the preferred direction and the particle's direction.  $|\mu| \leq 1$ . The preferred direction can be specified on a VECT card.

At a collision a particle's weight is multiplied by a factor  $w_c$  (derived below) so that the expected weight colliding at any point is preserved. The particle's weight is adjusted such that the weight multiplied by the probability that the next collision is in  $ds$  about  $s$  remains constant.

The probability of colliding in  $ds$  about  $s$  is

$$\Sigma e^{-\Sigma s} ds \quad ,$$

where  $\Sigma$  is either  $\Sigma_t$  or  $\Sigma_t^*$ , so that preserving the expected collided weight requires

$$\Sigma_t e^{-\Sigma_t s} ds = w_c \Sigma_t e^{-\Sigma_t^* s} ds \quad ,$$

or

$$w_c = \frac{\Sigma_t e^{-\Sigma_t s}}{\Sigma_t^* e^{-\Sigma_t^* s}} = \frac{e^{-\rho \Sigma_t \mu s}}{1 - p\mu} \quad .$$

If the particle reaches a cell surface, time cutoff, DXTRAN sphere, or tally segment instead of colliding, the particle's weight is adjusted so that the weight, multiplied by the probability that the particle travels a distance  $s$  to the surface, remains constant. The probability of traveling a distance  $s$  without collision is

$$e^{-\Sigma s} \quad ,$$

so that preserving the expected uncollided weight requires

$$e^{-\Sigma_t s} = w_s e^{-\Sigma_t^* s} \quad , \text{ or}$$

$$w_s = \frac{e^{-\Sigma_t s}}{e^{-\Sigma_t s}} = e^{-\rho \Sigma_t \mu s} .$$

For one-dimensional deep penetration through highly absorbing media, the variance typically will decrease as  $p$  goes from zero to some  $p'$ , and then increase as  $p$  goes from  $p'$  to one. For  $p < p'$ , the solution is “underbiased” and for  $p > p'$ , the solution is “overbiased.”

Choosing  $p'$  is usually a matter of experience, although some insight may be gleaned by understanding what happens in severely underbiased and severely overbiased calculations. For illustration, apply the variance analysis of page 2–109 to a deep penetration problem when the exponential transform is the only nonanalog technique used. In a severely underbiased calculation ( $p \rightarrow 0$ ), very few particles will score, but those that do will all contribute unity. Thus the variance in an underbiased system is caused by a low scoring efficiency rather than a large dispersion in the weights of the penetrating particles. In a severely overbiased system ( $p \rightarrow 1$ ) particles will score, but there will be a large dispersion in the weights of the penetrating particles with a resulting increase in variance.

Comments: MCNP gives a warning message if the exponential transform is used without a weight window. There are numerous examples where an exponential transform without a weight window gives unreliable means and error estimates. However, with a good weight window both the means and errors are well behaved. The exponential transform works best on highly absorbing media and very poorly on highly scattering media. For neutron penetration of concrete or earth, experience indicates that a transform parameter  $p = 0.7$  is about optimal. For photon penetration of high-Z material, even higher values such as  $p = 0.9$  are justified.

The following explains what happens with an exponential transform without a weight window. For simplicity consider a slab of thickness  $T$  with constant  $\Sigma_t$ . Let the tally be a simple count (F1 tally) of the weight penetrating the slab and let the exponential transform be the only nonanalog technique used. Suppose for a given penetrating history that there are  $k$  flights,  $m$  that collide and  $n$  that do not collide. The penetrating weight is thus:

$$w_p = \prod_{i=1}^m \frac{e^{-\rho \Sigma_t \mu_i s_i}}{(1 - p \mu_i)} \prod_{j=m+1}^k e^{-\rho \Sigma_t \mu_j s_j} .$$

However, the particle's penetration of the slab means that

$$\sum_{l=1}^k \mu_l s_l = T \quad \text{and hence}$$

## CHAPTER 2 VARIANCE REDUCTION

$$w_p = e^{-\rho \Sigma_t T} \prod_{i=1}^m (1 - p\mu_i)^{-1} .$$

The only variation in  $w_p$  is because of the  $(1 - p\mu)^{-1}$  factors that arise only from collisions. For a perfectly absorbing medium, every particle that penetrates scores exactly  $e^{-\rho \Sigma_t T}$ . If a particle has only a few collisions, the weight variation will be small compared to a particle that has many collisions. The weight window splits the particle whenever the weight gets too large, depriving the particle of getting a whole series of weight multiplications upon collision that are substantially greater than one.

By setting  $p = \Sigma_a / \Sigma_t$  and  $\mu = 1$  so that  $\Sigma^* = \Sigma_s$ , we sample distance to scatter rather than distance to collision. It is preferable to sample distance to scatter in highly absorbing media — in fact, this is the standard procedure for astrophysics problems. Sampling distance to scatter is also equivalent to implicit capture along a flight path (see page 2–35). However, in such highly absorbing media there is usually a more optimal choice of transform parameter,  $p$ , and it is usually preferable to take advantage of the directional component by not fixing  $\mu = 1$ .

=

### 8. Implicit Capture

“Implicit capture,” “survival biasing,” and “absorption by weight reduction” are synonymous. Implicit capture is a variance reduction technique applied in MCNP after the collision nuclide has been selected. Let

$$\begin{aligned} \sigma_{ti} &= \text{total microscopic cross section for nuclide } i \text{ and} \\ \sigma_{ai} &= \text{microscopic absorption cross section for nuclide } i. \end{aligned}$$

When implicit capture is used rather than sampling for absorption with probability  $\sigma_{ai} / \sigma_{ti}$ , the particle always survives the collision and is followed with new weight:  $W * (1 - \sigma_{ai} / \sigma_{ti})$ . Implicit capture is a splitting process where the particle is split into absorbed weight (which need not be followed further) and surviving weight.

Implicit capture can also be done along a flight path rather than at collisions when a special form of the exponential transform is used. See page 2–35 for details.

Two advantages of implicit capture are

1. a particle that has finally, against considerable odds, reached the tally region is not absorbed just before a tally is made, and
2. the history variance, in general, decreases when the surviving weight (that is, 0 or  $W$ ) is not sampled, but an expected surviving weight is used instead (see weight cutoff, page 2–136).

Two disadvantages are

1. a fluctuation in particle weight is introduced, and
2. the time per history is increased (see weight cutoff, page 2–136).

9. Forced Collisions

The forced collision method is a variance reduction scheme that increases sampling of collisions in specified cells. Because detector contributions and DXTRAN particles arise only from collisions and at the source, it is often useful in certain cells to increase the number of collisions that can produce large detector contributions or large weight DXTRAN particles. Sometimes we want to sample collisions in a relatively thin cell (a fraction of a mean free path) to improve the estimate of quantities like a reaction rate or energy deposition or to cause collisions that are important to some other part of the problem.

The forced collision method splits particles into collided and uncollided parts. The collided part is forced to collide within the current cell. The uncollided part exits the current cell without collision and is stored in the bank until later when its track is continued at the cell boundary. Its weight is

$$W = W_o e^{-\Sigma_t d} ,$$

where  $W_o$  = current particle weight before forced collision,  
 $d$  = distance to cell surface in the particle's direction, and  
 $\Sigma_t$  = macroscopic total cross section of the cell material.

That is, the uncollided part is the current particle weight multiplied by the probability of exiting the cell without collision.

The collided part has weight  $W = W_o(1 - e^{-\Sigma_t d})$ , which is the current particle weight multiplied by the probability of colliding in the cell. The uncollided part is always produced. The collided part may be produced only a fraction  $f$  of the time, in which case the collided weight is  $W_o(1 - e^{-\Sigma_t d})/f$ . This is useful when several forced collision cells are adjacent or when too much time is spent producing and following forced collision particles.

The collision distance is sampled as follows. If  $P(x)$  is the unconditional probability of colliding within a distance  $x$ ,  $P(x)/P(d)$  is the conditional probability of colliding within a distance  $x$  given that a collision is known to occur within a distance  $d$ . Thus the position  $x$  of the collision must be sampled on the interval  $0 < x < d$  within the cell according to  $\xi = P(x)/P(d)$ , where  $P(x) = 1 - e^{-x\Sigma_t}$  and  $\xi$  is a random number. Solving for  $x$ , one obtains



## CHAPTER 2 VARIANCE REDUCTION

$$x = -\frac{1}{\Sigma_t} \ln[1 - \xi(1 - e^{-d\Sigma_t})] .$$

Because a forced collision usually yields a collided particle having a relatively small weight, care must be taken with the weight-cutoff game (page 2–136), the weight-window game (page 2–137), and subsequent collisions of the particle within the cell. The weight window game is not played on the surface of a forced collision cell that the particle is entering. For collisions inside the cell the user has two options.

Option 1: (negative entry for the cell on the forced collision card.) After the forced collision, subsequent collisions of the particle are sampled normally. The weight cutoff game is turned off and detector contributions and DXTRAN particles are made before the weight window game is played. If weight windows are used, they should be set to the weight of the collided particle weight or set to zero if detector contributions or DXTRAN particles are desired.

Option 2: (positive entry for the cell on the forced collision card.) After the forced collision, detector contributions or DXTRAN particles are made and either the weight cutoff or weight window game is played. Surviving collided particles undergo subsequent forced collisions. If weight windows are used, they should bracket the weight of particles entering the cell.

### 10. Source Variable Biasing

Provision is made for biasing the MCNP sources in any or all of the source variables specified. MCNP's source biasing, although not completely general, allows the production of more source particles, with suitably reduced weights, in the more important regimes of each variable. For example, one may start more “tracks” at high energies and in strategic directions in a shielding problem while correcting the distribution by altering the weights assigned to these tracks. Sizable variance reductions may result from such biasing of the source. Source biasing samples from a nonanalog probability density function.

If negative weight cutoff values are used on the CUT card, the weight cutoff is made relative to the lowest value of source particle weight generated by the biasing schemes.

Source biasing is the only variance reduction scheme allowed with F8 tallies having energy binning (see page 2–83).

1. **Biasing by Specifying Explicit Sampling Frequencies:** The SB input card determines source biasing for a particular variable by specifying the frequency at which source particles will be produced in the variable regime. If this fictitious frequency does not correspond to the fraction of actual source particles in a variable bin, the corrected weight of the source particles in a particular bin is determined by the ratio of the actual frequency (defined on the SP card) divided by the fictitious frequency (defined on the

SB card) except for the lin-lin interpolation where it is defined to be the ratio of the actual to fictitious frequency evaluated at the exact value of the interpolated variable. The total weight of particles started in a given SI bin interval is thus conserved.

2. **Biassing by Standard Prescription:** Source biassing can use certain built-in prescriptions similar in principle to built-in analytic source distributions. These biassing options are detailed in the sections below for the appropriate source variables. The SB card input is analogous to that of an SP card for an analytic source distribution; that is, the first entry is a negative prescription number for the type of biassing required, followed by one or more optional user-specified parameters, which are discussed in the following sections.

- a. **Direction Biassing:** The source direction can be biassed by sampling from a continuous exponential function or by using cones of fixed size and starting a fixed fraction of particles within each cone. The user can bias particles in any arbitrary direction or combination of directions.

In general, continuous biassing is preferable to fixed cone biassing because cone biassing can cause problems from the discontinuities of source track weight at the cone boundaries. However, if the cone parameters (cone size and fraction of particles starting in the cone) are optimized through a parameter study and the paths that tracks take to contribute to tallies are understood, fixed cone biassing sometimes can outperform continuous biassing. Unfortunately, it is usually time consuming (both human and computer) and difficult to arrive at the necessary optimization.

Source directional biassing can be sampled from an exponential probability density function  $p(\mu) = Ce^{K\mu}$ , where  $C$  is a norming constant equal to  $K/(e^K - e^{-K})$  and  $\mu = \cos\theta$ , where  $\theta$  is an angle relative to the biassing direction.  $K$  is typically about 1;  $K = 3.5$  defines the ratio of weight of tracks starting in the biassing direction to tracks starting in the opposite direction to be 1/1097. This ratio is equal to  $e^{-2K}$ .

Table 2.6 may help to give you a feel for the biassing parameter  $K$ .

**TABLE 2.6:**  
**Exponential Biassing Parameter**

K	Cumulative Probability	Theta	Weight	<u>K</u>	Cumulative Probability	Theta	Weight
.01	0	0	0.990	2.0	0	0	.245
	.25	60	0.995		.25	31	.325
	.50	90	1.000		.50	48	.482
	.75	120	1.005		.75	70	.931
	1.00	180	1.010		1.00	180	13.40

**CHAPTER 2**  
**VARIANCE REDUCTION**

**TABLE 2.6:**  
**Exponential Biasing Parameter**

1.0	0	0	.432	3.5	0	0	.143
	.25	42	.552		.25	23	.190
	.50	64	.762		.50	37	.285
	.75	93	1.230		.75	53	.569
	1.00	180	3.195		1.00	180	156.5

From this table for  $K = 1$ , we see that half the tracks start in a cone of  $64^\circ$  opening about the axis, and the weight of tracks at  $64^\circ$  is 0.762 times the unbiased weight of source particles.  $K = 0.01$  is almost equivalent to no biasing, and  $K = 3.5$  is very strong.

Cone directional biasing can be invoked by specifying cone cosines on the SI card, the true distribution on the SP card, and the desired biasing probabilities on the SB card. Both histogram and linear interpolation can be used. For example, consider the following case in which the true distribution is isotropic:

$$SI n - 1 \nu 1$$

$$SP n 0 \frac{1 + \nu}{2} \frac{1 - \nu}{2}$$

$$SB n 0 p_1 p_2$$

The direction cosine relative to the reference direction, say  $\nu$ , is sampled uniformly within the cone  $\nu < \nu < 1$  with probability  $p_2$  and within  $-1 < \nu < \nu$  with the complementary probability  $p_1$ . The weights assigned are  $W(1 - \nu)/(2p_2)$  and  $W(1 + \nu)/(2p_1)$ , respectively. Note that for a very small cone defined by  $\nu$  and a high probability  $p_2 \gg p_1$  for being within the cone, the few source particles generated outside the cone will have a very high weight that can severely perturb a tally. The sampling of the direction cosines azimuthal to the reference axis is not biased.

**b. Covering Cylinder Extent Biasing:** This biasing prescription for the SDEF EXT variable allows the automatic spatial biasing of source particles in a cylindrical-source-covering-volume along the axis of the cylinder. Such biasing can aid in the escape of source particles from optically thick source regions and thus represents a variance reduction technique.

**c. Covering Cylinder or Sphere Radial Biasing:** This biasing prescription for the SDEF RAD variable allows for the radial spatial biasing of source particles in either a spherical or cylindrical source covering volume. Like the previous example of extent biasing, this biasing can be used to aid in the escape of source particles from optically thick source regions.

3. **Biasing Standard Analytic Source Functions:**<sup>103</sup> The preceding examples discuss the biasing of source variables by either input of specific sampling frequencies corresponding to SP card entries or by standard analytic biasing functions. A third biasing category can be used in conjunction with standard analytic source probability functions (for example, a Watt fission spectrum).

A negative entry on an SP card, that is,

```
SPn -i a b
```

causes MCNP to sample source distribution  $n$  from probability function  $i$  with input variables  $a, b, \dots$ . Sampling schemes are typically unbiased. For example, for

```
SPn -5 a
```

the evaporation spectrum  $f(E) = C E \exp(-E/a)$  is sampled according to the sampling prescription  $E = -a \log(\xi_1 * \xi_2)$ , where  $\xi_{i_1}$  and  $\xi_{i_2}$  are random numbers. Biasing this sampling scheme is usually very difficult or impossible. Fortunately, there is an approximate method available in MCNP for biasing any arbitrary probability function.<sup>103</sup> The code approximates the function as a table, then uses the usual SB card biasing scheme to bias this approximate table function. The user inputs a coarse bin structure to govern the bias and the code adds up to 300 additional equiprobable bins to assure accuracy. For example, suppose we wish to sample the function

$$f(E) = C E \exp(-E/a)$$

and suppose that we want half the source to be in the range  $.005 < E < .1$  and the other half to be in the range  $.1 < E < 20$ . Then the input is

```
SPn -5 a
```

```
SIn .005 .1 20
```

```
SBn C 0 .5 1 .
```

MCNP breaks up the function into 150 equiprobable bins below  $E = .1$  and 150 more equiprobable bins above  $E = .1$ . Half the time  $E$  is chosen from the upper set of bins and half the time it is chosen from the lower set. Particles starting from the upper bins have a different weight than that of particles starting from the lower bins to adjust for the bias, and a detailed summary is provided when the PRINT option is used.

Note that in the above example the probability distribution function is truncated below  $E = .005$  and above  $E = 20$ . MCNP prints out how much of the distribution is lost in this manner and reduces the weight accordingly.

It is possible for the user to choose a foolish biasing scheme. For example,

```
SPn -5 a
```

```
SIn .005 297I .1 20
```

```
SBn 0 1 298R
```

## CHAPTER 2

### VARIANCE REDUCTION

causes each of the 299 bins to be chosen with equal probability. This would be all right except that since there are never more than 300 equiprobable bins, this allocates only 1 equiprobable bin per user-supplied bin. The single equiprobable bin for  $.1 < E < 20$  is inadequate to describe the distribution function over this range. Thus the table no longer approximates the function and the source will be sampled erroneously. MCNP issues an error message whenever too much of the source distribution is allocated to a single equiprobable bin, alerting users to a poor choice of binning which might inadequately represent the function. The coarse bins used for biasing should be chosen so that the probability function is roughly equally distributed among them.

#### 11. Point Detector Tally

The point detector is a tally and does not bias random walk sampling. Recall from Section VI, however, that the tally choice affects the efficiency of a Monte Carlo calculation. Thus, a little will be said here in addition to the discussion in the tally section.

Although flux is a point quantity, flux at a point cannot be estimated by either a track-length tally (F4) or a surface flux tally (F2) because the probability of a track entering the volume or crossing the surface of a point is zero. For very small volumes, a point detector tally can provide a good estimate of the flux where it would be almost impossible to get either a track-length or surface-crossing estimate because of the low probability of crossing into the small volume.

It is interesting that a DXTRAN sphere of vanishingly small size with a surface-crossing tally across the diameter normal to the particle's trajectory is equivalent to a point detector. Thus, many of the comments on DXTRAN are appropriate and the DXC cards essentially are identical to the PD cards.

For a complete discussion of point detectors, see page 2–75.

#### 12. DXTRAN

DXTRAN typically is used when a small region is being inadequately sampled because particles have a very small probability of scattering toward that region. To ameliorate this situation, the user can specify in the input file a DXTRAN sphere that encloses the small region. Upon collision (or exiting the source) outside the sphere, DXTRAN creates a special “DXTRAN particle” and deterministically scatters it toward the DXTRAN sphere and deterministically transports it, without collision, to the surface of the DXTRAN sphere. The collision itself is otherwise treated normally, producing a non-DXTRAN particle that is sampled in the normal way, with no reduction in weight. However, the non-DXTRAN particle is killed if it tries to enter the DXTRAN sphere. DXTRAN uses a combination of splitting, Russian roulette, and sampling from a nonanalog probability density function.

The subtlety about DXTRAN is how the extra weight created for the DXTRAN particles is balanced by the weight killed as non-DXTRAN particles cross the DXTRAN sphere. The non-DXTRAN particle is followed without any weight correction, so if the DXTRAN technique is to be unbiased, the extra weight put on the DXTRAN sphere by DXTRAN particles must somehow (on average) balance the weight of non-DXTRAN particles killed on the sphere.

1. DXTRAN Viewpoint 1: One can view DXTRAN as a splitting process (much like the forced collision technique) wherein each particle is split upon departing a collision (or source point) into two distinct pieces:
  - a. the weight that does not enter the DXTRAN sphere on the next flight, either because the particle is not pointed toward the DXTRAN sphere or because the particle collides before reaching the DXTRAN sphere, and
  - b. the weight that enters the DXTRAN sphere on the next flight.

Let  $w_o$  be the weight of the particle before exiting the collision, let  $p_1$  be the analog probability that the particle does not enter the DXTRAN sphere on its next flight, and let  $p_2$  be the analog probability that the particle does enter the DXTRAN sphere on its next flight. The particle must undergo one of these mutually exclusive events, thus  $p_1 + p_2 = 1$ . The expected weight not entering the DXTRAN sphere is  $w_1 = w_o p_1$ , and the expected weight entering the DXTRAN sphere is  $w_2 = w_o p_2$ . Think of DXTRAN as deterministically splitting the original particle with weight  $w_o$  into two particles, a non-DXTRAN (particle 1) particle of weight  $w_1$  and a DXTRAN (particle 2) particle of weight  $w_2$ . Unfortunately, things are not quite that simple.

Recall that the non-DXTRAN particle is followed with unreduced weight  $w_o$  rather than weight  $w_1 = w_o p_1$ . The reason for this apparent discrepancy is that the non-DXTRAN particle (#1) plays a Russian roulette game. Particle 1's weight is increased from  $w_1$  to  $w_o$  by playing a Russian roulette game with survival probability  $p_1 = w_1/w_o$ . The reason for playing this Russian roulette game is simply that  $p_1$  is not known, so assigning weight  $w_1 = p_1 w_o$  to particle 1 is impossible. However, it is possible to play the Russian roulette game without explicitly knowing  $p_1$ . It is not magic, just slightly subtle.

The Russian roulette game is played by sampling particle 1 normally and keeping it only if it does not enter (on its next flight) the DXTRAN sphere; that is, particle 1 survives (by definition of  $p_1$ ) with probability  $p_1$ . Similarly, the Russian roulette game is lost if particle 1 enters (on its next flight) the DXTRAN sphere; that is, particle 1 loses the roulette with probability  $p_2$ . To restate this idea, with probability  $p_1$ , particle 1 has weight  $w_o$  and does not enter the DXTRAN sphere and with probability  $p_2$ , the particle enters the DXTRAN sphere and is killed. Thus, the expected weight not entering the DXTRAN sphere is  $w_o p_1 + 0 * p_2 = w_1$ , as desired.

So far, this discussion has concentrated on the non-DXTRAN particle and ignored exactly what happens to the DXTRAN particle. The sampling of the DXTRAN particle will be discussed after a second viewpoint on the non-DXTRAN particle.

## CHAPTER 2 VARIANCE REDUCTION

2. DXTRAN Viewpoint 2: This second way of viewing DXTRAN does not see DXTRAN as a splitting process but as an accounting process in which weight is both created and destroyed on the surface of the DXTRAN sphere. In this view, DXTRAN estimates the weight that should go to the DXTRAN sphere upon collision and creates this weight on the sphere as DXTRAN particles. If the non-DXTRAN particle does not enter the sphere, its next flight will proceed exactly as it would have without DXTRAN, producing the same tally contributions and so forth. However, if the non-DXTRAN particle's next flight attempts to enter the sphere, the particle must be killed or there would be (on average) twice as much weight crossing the DXTRAN sphere as there should be because the weight crossing the sphere has already been accounted for by the DXTRAN particle.
3. The DXTRAN Particle: Although the DXTRAN particle does not confuse people nearly as much as the non-DXTRAN particle, the DXTRAN particle is nonetheless subtle.

The most natural approach for scattering particles toward the DXTRAN sphere would be to sample the scattering angle  $\Omega$  proportional to the analog density. This approach is not used because it is too much work to sample proportional to the analog density and because it is sometimes useful to bias the sampling.

To sample  $\Omega$  in an unbiased fashion when it is known that  $\Omega$  points to the DXTRAN sphere, one samples the conditional density

$$P_{con}(\Omega) = P(\Omega) / \int_{S(\Omega)} P(\Omega) d\Omega \quad (\text{the set } S(\Omega) \text{ points toward the sphere})$$

and multiplies the weight by  $\int_{S(\Omega)} P(\Omega) d(\Omega)$ , the probability of scattering into the cone (see Fig. 2-19). However, it is too much work to calculate the above integral for each collision. Instead, an arbitrary density function  $P_{arb}(\Omega)$  is sampled and the weight is multiplied by

$$\frac{P_{con}(\Omega)}{P_{arb}(\Omega)} = \frac{P(\Omega)}{P_{arb}(\Omega) \int_{S(\Omega)} P(\Omega) d(\Omega)}$$

The total weight multiplication is the product of the fraction of the weight scattering into the cone,  $\int_{S(\Omega)} P(\Omega) d\Omega$ , and the weight correction for sampling  $P_{arb}(\Omega)$  instead of  $P_{con}(\Omega)$ . Thus, the weight correction on scattering is

$$P(\Omega)P_{arb}(\Omega).$$

If  $\mu$  is the cosine of the angle between the scattering direction and the particle's incoming direction, then  $P(\Omega) = P(\mu)/(2\pi)$  because the scattering is symmetric in the azimuthal angle. If  $\eta$  is the cosine of the angle with respect to the cone axis (see Fig. 2-19) and if the azimuthal angle about the cone axis is uniformly sampled, then  $P_{arb}(\Omega) = P_{arb}(\eta)/(2\pi)$ . Thus

$$\frac{P(\mu)}{P_{arb}(\eta)} = \text{weight multiplier for DXTRAN particle.}$$

This result can be obtained more directly, but the other derivation does not explain why  $P_{con}(\Omega)$  is not sampled.

Because  $P_{arb}(\eta)$  is arbitrary, MCNP can choose a scheme that samples  $\eta$  from a two-step density that favors particles within the larger  $\eta$  interval. In fact, the inner DXTRAN sphere has to do only with this arbitrary density and is not essential to the DXTRAN concept. The DXTRAN particles are always created on the outside DXTRAN sphere, with the inner DXTRAN sphere defining only the boundary between the two steps in the density function.

After  $\eta = \cos \theta$  has been chosen, the azimuthal angle  $\phi$  is sampled uniformly on  $[0, 2\pi]$ ; this completes the scattering. Recall, however, that the DXTRAN particle arrives at the DXTRAN sphere without collision. Thus the DXTRAN particle also has its weight multiplied by the negative exponential of the optical path between the collision site and the sphere.

4. Inside the DXTRAN Sphere: So far, only collisions outside the DXTRAN sphere have been discussed. At collisions inside the DXTRAN sphere, the DXTRAN game is not played because first, the particle is already in the desired region, and second, it is impossible to define the angular cone of Fig. 2-19. If there are several DXTRAN spheres and the collision occurs in sphere  $i$ , DXTRAN will be played for all spheres except sphere  $i$ .
5. Terminology—Real particle and Pseudoparticle: Sometimes the DXTRAN particle is called a pseudoparticle and the non-DXTRAN particle is called the original or real particle. The terms “real particle” and “pseudoparticle” are potentially misleading. Both particles are equally real: both execute random walks, both carry nonzero weight, and both contribute to tallies. The only sense in which the DXTRAN particle should be considered “pseudo” or “not real” is during creation. A DXTRAN particle is created on the DXTRAN sphere, but creation involves determining what weight the DXTRAN particle should have upon creation. Part of this weight determination requires calculating the optical path between the collision site and the DXTRAN sphere. This is done in the same way as point detectors (see point detector pseudoparticles on page 2–90.) MCNP determines the optical path by tracking a



**CHAPTER 2**  
**VARIANCE REDUCTION**

pseudoparticle from the collision site to the DXTRAN sphere. This pseudoparticle is deterministically tracked to the DXTRAN sphere simply to determine the optical path. No distance to collision is sampled, no tallies are made, and no records of the pseudoparticle's passage are kept (for example, tracks entering). In contrast, once the DXTRAN particle is created at the sphere's surface, the particle is no longer a pseudoparticle. The particle has real weight, executes random walks, and contributes to tallies.

6. DXTRAN Details: To explain how the scheme works, consider the neighborhood of interest to be a spherical region surrounding a designated point in space. In fact, consider two spheres of arbitrary radii about the point  $P_o = (x_o, y_o, z_o)$ . Further, assume that the particle having direction  $(u, v, w)$  collides at the point  $P_I = (x, y, z)$ , as shown in Fig. 2-19.

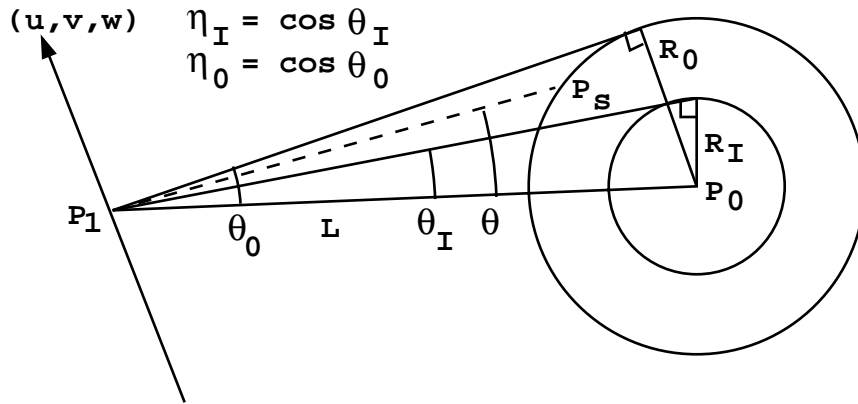

**Figure 2-19.**

The quantities  $\theta_I$ ,  $\theta_O$ ,  $\eta_I$ ,  $\eta_O$ ,  $R_I$ , and  $R_O$  are defined in the figure. Thus  $L$ , the distance between the collision point and center of the spheres, is

$$L = \sqrt{(x - x_o)^2 + (y - y_o)^2 + (z - z_o)^2} .$$

On collision, a DXTRAN particle is placed at a point on the outer sphere of radius  $R_o$  as described below. Provision is made for biasing the contributions of these DXTRAN particles on the outer sphere within the cone defined by the inner sphere. The weight of the DXTRAN particle is adjusted to account for the probability of scattering in the direction of the point on the outer sphere and traversing the distance with no further collision.

The steps in sampling the DXTRAN particles are outlined:

$$\eta_I = \cos\theta_I = (L^2 - R_I^2)^{1/2}/L$$

$$\eta_O = \cos\theta_O = (L^2 - R_O^2)^{1/2}/L$$

Sample  $\eta = \eta_I + \xi(1 - \eta_I)$  uniformly in  $(\eta_I, 1)$  with probability

$$Q(1 - \eta_I)/[Q(1 - \eta_I) + \eta_I - \eta_O]$$

and with probability

$$(\eta_I - \eta_O)/[Q(1 - \eta_I) + \eta_I - \eta_O]$$

sample  $\eta = \eta_O + \xi(\eta_I - \eta_O)$  uniformly in  $(\eta_O, \eta_I)$ . The quantity  $Q$  (equal to 5 in MCNP) is a factor that measures the importance assigned to scattering in the inner cone relative to the outer cone. Therefore,  $Q$  is also the ratio of weights for particles put in the two different cones.

With  $\eta = \cos \theta$  chosen, a new direction  $(u', v', w')$  is computed by considering the rotation through the polar angle  $\theta$  (and a uniform azimuthal angle  $\phi$ ) from the reference direction

$$\left( \frac{x_o - x}{L}, \frac{y_o - y}{L}, \frac{z_o - z}{L} \right) .$$

The particle is advanced in the direction  $(u', v', w')$  to the surface of the sphere of radius  $R_O$ . The new DXTRAN particle with appropriate direction and coordinates is banked. The weight of the DXTRAN particle is determined by multiplying the weight of the particle at collision by

$$v \cdot \frac{P(\mu)\{Q(1 - \eta_I) + \eta_I - \eta_O\}e^{-\int_{P_I}^{P_S} \sigma_t(s)ds}}{Q}, \quad \eta_I \leq \eta \leq 1 \quad \text{and}$$

$$v \cdot P(\mu)\{Q(1 - \eta_I) + \eta_I - \eta_O\}e^{-\int_{P_I}^{P_S} \sigma_t(s)ds}, \quad \eta_O \leq \eta \leq \eta_I$$

where

$$\mu = uu' + vv' + ww',$$

$$P(\mu) = \text{scattering probability density function for scattering through the angle } \cos^{-1} \mu \text{ in the lab system for the event sampled at } (x, y, z),$$

## CHAPTER 2 VARIANCE REDUCTION

$v$  = number of particles emitted from the event, and

$e^{-\int_{P_I}^{P_S} \Sigma_t(s) ds}$  = the attenuation along the line between  $P_I(x,y,z)$  and  $P_S$ , the point on the sphere where the particle is placed.

In arriving at the weight factor, note that the density function for sampling  $\eta$  is given by

$$Q/[Q(1 - \eta_I) + \eta_I - \eta_O], \eta_I < \eta \leq 1$$

$$1/([Q(1 - \eta_I) + \eta_I - \eta_O]), \eta_O \leq \eta \leq \eta_I \quad .$$

Thus the weight of the DXTRAN particle is the weight of the incoming particle at  $P_I$  modified by the ratio of the probability density function for actually scattering from  $P_I$  and arriving at  $P_S$  without collision to the density function actually sampled in choosing  $P_S$ . Therefore, particles in the outer cone have weights  $Q = 5$  times higher than the weights of similar particles in the inner cone.

The attenuation is calculated at the energy obtained by scattering through the angle  $\mu$ . The energy is uniquely determined from  $\mu$  in elastic scattering (and also in level scattering), whereas for other nonelastic events, the energy is sampled from the corresponding probability density function for energy, and may not depend on  $\mu$ .

7. Auxiliary Games for DXTRAN: The major disadvantage to DXTRAN is the extra time consumed following DXTRAN particles with low weights. Three special games can control this problem:
  1. DXTRAN weight cutoffs,
  2. DXC games, and
  3. DD game.

Particles inside a DXTRAN sphere are not subject to the normal MCNP weight cutoff or weight window game. Instead DXTRAN spheres have their own weight cutoffs, allowing the user to roulette DXTRAN particles that, for one reason or another, do not have enough weight to be worth following.

Sometimes low-weighted DXTRAN particles occur because of collisions many free paths from the DXTRAN sphere. The exponential attenuation causes these particles to have extremely small weights. The DXTRAN weight cutoff will roulette these particles only after much effort has been spent producing them. The DXC cards are cell dependent and allow DXTRAN contributions to be taken only some fraction of the time. They work just like the PD cards for detectors (see page 2-92). The user

specifies a probability  $p_i$  that a DXTRAN particle will be produced at a given collision or source sampling in cell  $i$ . The DXTRAN result remains unbiased because when a DXTRAN particle is produced its weight is multiplied by  $p_i^{-1}$ . (The non-DXTRAN particle is treated exactly as before, unaffected unless it enters the DXTRAN sphere, whereupon it is killed.) To see the utility, suppose that the DXTRAN weight cutoff was immediately killing 99% of the DXTRAN particles from cell  $i$ . Only 1% of the DXTRAN particles survive anyway, so it might be appropriate to produce only 1% ( $p_i = .01$ ) and have these not be killed immediately by the DXTRAN weight cutoff. Or the  $p_i$ 's can often be set such that all DXTRAN particles from all cells are created on the DXTRAN sphere with roughly the same weight. Choosing the  $p_i$ 's is often difficult and the method works well typically when the material exponential attenuation is the major source of the weight fluctuation.

Often the weight fluctuation arises because the probability  $P(\mu)$  of scattering toward the DXTRAN sphere varies greatly, depending on what nuclide is hit and what the collision orientation is with respect to the DXTRAN sphere. For example, consider a highly forward-peaked scattering probability density. If the DXTRAN sphere were close to the particle's precollision direction,  $P(\mu)$  will be large; if the DXTRAN sphere were at  $105^\circ$  to the precollision direction,  $P(\mu)$  will be small. The DD game can be used to reduce the weight fluctuation on the DXTRAN sphere caused by these geometry effects, as well as the material exponential attenuation effects.

The DD game selectively roulettes the DXTRAN pseudoparticles during creation, depending on the DXTRAN particles' weight compared to some reference weight. This is the same game that is played on detector contributions, and is described on page 2-92. The reference weight can be either a fraction of the average of previous DXTRAN particle weights or a user input reference weight. Recall that a DXTRAN particle's weight is computed by multiplying the exit weight of the non-DXTRAN particle by a weight factor having to do with the scattering probability and the negative exponential of the optical path between collision site and DXTRAN sphere. The optical path is computed by tracking a pseudoparticle from collision to DXTRAN sphere. The weight of the pseudoparticle is monotonically decreasing, so the DD game compares the pseudoparticle's weight at the collision site and, upon exiting each cell, against the reference weight. A roulette game is played when the pseudoparticle's weight falls below the reference weight. The DD card stops tracking a pseudoparticle as soon as the weight becomes inconsequential, saving time by eliminating subsequent tracking.

8. Final Comments:
  - a. DXTRAN should be used carefully in optically thick problems. Do not rely on DXTRAN to do penetration.

## CHAPTER 2

### VARIANCE REDUCTION

- b. If the source is user supplied, some provision must be made for obtaining the source contribution to particles on the DXTRAN sphere.
- c. Extreme care must be taken when more than one DXTRAN sphere is in a problem. Cross-talk between spheres can result in extremely low weights and an excessive growth in the number of particle tracks.
- d. Never put a zero on the DXC card. A zero will bias the calculation by not creating DXTRAN particles but still killing the non-DXTRAN particle if it enters the DXTRAN sphere.
- e. Usually there should be a rough balance in the summary table of weight created and lost by DXTRAN.
- f. DXTRAN cannot be used with reflecting surfaces for the same reasons that point detectors cannot be used with reflecting surfaces. See page 2–92 for further explanation.
- g. Both DXTRAN and point detectors track pseudoparticles to a point. Therefore, most of the discussion about detectors applies to DXTRAN. Refer to the section on detectors, page 2–85, for more information.

#### 13. Correlated Sampling

Correlated sampling estimates the change in a quantity resulting from a small perturbation of any type in the problem. This technique enables the evaluation of small quantities that would otherwise be masked by the statistical errors of uncorrelated calculations. MCNP correlates a pair of runs by providing each new history in the unperturbed and perturbed problems with the same initial pseudorandom number. The same sequence of subsequent numbers is used, until a perturbation causes the sequences to diverge. This sequencing is done by incrementing the random number generator at the beginning of each history by a stride  $S$  of random numbers from the beginning of the previous history. The default value of  $S$  is 152,917. The stride should be a quantity greater than would be needed by most histories (see page 2–187).

MCNP does not provide an estimate of the error in the difference. Reference 98 shows how the error in the difference between two correlated runs can be estimated. A postprocessor code would have to be written to do this.

Correlated sampling should not be confused with more elaborate Monte Carlo perturbation schemes that calculate differences and their variances directly. MCNP has no such scheme at present.

## ***VIII. CRITICALITY CALCULATIONS***

Nuclear criticality, the ability to sustain a chain reaction by fission neutrons, is characterized by  $k_{eff}$ , the eigenvalue to the neutron transport equation. In reactor theory,  $k_{eff}$  is thought of as the ratio between the number of neutrons in successive generations, with the fission process regarded as the birth event that separates generations of neutrons.<sup>104</sup> For critical systems,  $k_{eff} = 1$  and the chain reaction will just sustain itself. For subcritical systems,  $k_{eff} < 1$  and the chain reaction will not sustain itself. For supercritical systems,  $k_{eff} > 1$  and the number of fissions in the chain reaction will increase with time. In addition to the geometry description and material cards, all that is required to run a criticality problem is a KCODE card, described below, and an initial spatial distribution of fission points using either the KSRC card, the SDEF card, or an SRCTP file.

Calculating  $k_{eff}$  consists of estimating the mean number of fission neutrons produced in one generation per fission neutron started. A generation is the life of a neutron from birth in fission to death by escape, parasitic capture, or absorption leading to fission. In MCNP, the computational equivalent of a fission generation is a  $k_{eff}$  cycle; i.e., a cycle is a computed estimate of an actual fission generation. Processes such as  $(n,2n)$  and  $(n,3n)$  are considered internal to a cycle and do not act as termination. Because fission neutrons are terminated in each cycle to provide the fission source for the next cycle, a single history can be viewed as continuing from cycle to cycle. The effect of the delayed neutrons is included by using the total  $\bar{\nu}$ . The spectrum of delayed neutrons is assumed to be the same as neutrons from prompt fission. In a Mode N,P problem, secondary photon production from neutrons is turned off during inactive cycles. MCNP uses three different estimators for  $k_{eff}$ . We recommend using, for the final  $k_{eff}$  result, the statistical combination of all three.<sup>105</sup>

It is extremely important to emphasize that the result from a criticality calculation is a confidence interval for  $k_{eff}$  that is formed using the final estimated  $k_{eff}$  and the estimated standard deviation. A properly formed confidence interval from a valid calculation should include the true answer the fraction of time used to define the confidence interval. There will always be some probability that the true answer lies outside of a confidence interval.

Reference 106 is an introduction to using MCNP for criticality calculations, focusing on the unique aspects of setting up and running a criticality problem and interpreting the results. A quickstart chapter gets the new MCNP user on the computer running a simple criticality problem as quickly as possible.

### ***A. Criticality Program Flow***

Because the calculation of  $k_{eff}$  entails running successive fission cycles, criticality calculations have a different program flow than MCNP fixed source problems. They require a special

## CHAPTER 2 CRITICALITY CALCULATIONS

criticality source that is incompatible with the surface source and user-supplied sources. Unlike fixed source problems, where the source being sampled throughout the problem never changes, the criticality source changes from cycle to cycle.

### 1. Criticality Problem Definition

To set up a criticality calculation, the user initially supplies an INP file that includes the KCODE card with the following information:

1. the nominal number of source histories,  $N$ , per  $k_{eff}$  cycle;
2. an initial guess of  $k_{eff}$ ;
3. the number of source cycles,  $I_c$ , to skip before  $k_{eff}$  accumulation;
4. the total number of cycles,  $I_t$ , in the problem.

Other KCODE entries are discussed in Chapter 3, page 3–70. The initial spatial distribution of fission neutrons can be entered by using (1) the KSRC card with sets of  $x,y,z$  point locations, (2) the SDEF card to define points uniformly in volume, or (3) a file (SRCTP) from a previous MCNP criticality calculation. If the SDEF card is used, the default WGT value should not be changed. Any KSRC points in geometric cells that are void or have zero importance are rejected. The remaining KSRC points are duplicated or rejected enough times so the total number of points  $M$  in the source spatial distribution is approximately the nominal source size  $N$ . The energy of each source particle for the first  $k_{eff}$  cycle is selected from a generic Watt thermal fission distribution if it is not available from the SRCTP file.

### 2. Particle Transport for Each $k_{eff}$ Cycle

In each  $k_{eff}$  cycle,  $M$  (varying with cycle) source particles are started isotropically. For the first cycle, these  $M$  points come from one of three user-selected source possibilities. For subsequent cycles, these points are the ones written at collision sites from neutron transport in the previous cycle. The total source weight of each cycle is a constant  $N$ . That is, the weight of each source particle is  $N/M$ , so all normalizations occur as if  $N$  rather than  $M$  particles started in each cycle.

Source particles are transported through the geometry by the standard random walk process, except that fission is treated as capture, either analog or implicit as defined on the PHYS:N or CUT:N card. At each collision point the following four steps are performed for the cycle:

1. the three prompt neutron lifetime estimates are accumulated;
2. if fission is possible, the three  $k_{eff}$  estimates are accumulated; and
3. if fission is possible,  $n \geq 0$  fission sites (including the sampled outgoing energy of the fission neutron) at each collision are stored for use as source points in the next cycle,

where

- $n$  =  $W\bar{\nu}(\sigma_f/\sigma_t)(1/k_{eff})$  + random number;
- $W$  = particle weight (before implicit capture weight reduction or analog capture);
- $\bar{\nu}$  = average number of neutrons produced by fission at the incident energy of this collision, with either prompt  $\bar{\nu}$  or total  $\bar{\nu}$  (default) used;
- $\sigma_f$  = microscopic material fission cross section;
- $\sigma_t$  = microscopic material total cross section; and
- $k_{eff}$  = estimated collision  $k_{eff}$  from previous cycle.  
For first cycle, the second KCODE card entry.

$M = \sum n$  = number of fission source points to be used in next cycle. The number of fission sites  $n$  stored at each collision is rounded up or down to an integer (including zero) with a probability proportional to its closeness to that integer. If the initial guess of  $k_{eff}$  is too low or too high, the number of fission sites written as source points for the next cycle will be, respectively, too high or too low relative to the desired nominal number  $N$ . A bad initial guess of  $k_{eff}$  causes only this consequence.

A very poor initial guess for the spatial distribution of fissions can cause the first cycle estimate of  $k_{eff}$  to be extremely low. This situation can occur when only a fraction of the fission source points enter a cell with a fissionable material. As a result, one of two error messages can be printed: (1) no new source points were generated, or (2) the new source has overrun the old source. The second message occurs when the MCNP storage for the fission source points is exceeded because the small  $k_{eff}$  that results from a poor initial source causes  $n$  to become very large.

The fission energy of the next-cycle neutron is sampled separately for each source point and stored for the next cycle. It is sampled from the same distributions as fissions would be sampled in the random walk based on the incident neutron energy and fissionable isotope. The geometric coordinates and cell of the fission site are also stored.

4. The collision nuclide and reaction are sampled (after steps 1, 2, and 3) but the fission reaction is not allowed to occur because fission is treated as capture. The fission neutrons that would have been created are accrued in three different ways to estimate  $k_{eff}$  for this cycle.

### 3. $k_{eff}$ Cycle Termination

At the end of each  $k_{eff}$  cycle, a new set of  $M$  source particles has been written from fissions in that cycle. The number  $M$  varies from cycle to cycle but the total starting weight in each cycle is a constant  $N$ . These  $M$  particles are written to the SRCTP file at certain cycle intervals. The



## CHAPTER 2 CRITICALITY CALCULATIONS

SRCTP file can be used as the initial source in a subsequent criticality calculation with a similar, though not identical, geometry. Also,  $k_{eff}$  quantities are accumulated, as is described below.

The first  $I_c$  cycles in a criticality calculation are inactive cycles, where the spatial source changes from the initial definition to the correct distribution for the problem. No  $k_{eff}$  accumulation, summary table, activity table, or tally information is accrued for inactive cycles. Photon production, perturbations, and DXTRAN are turned off during inactive cycles.  $I_c$  is an input parameter on the KCODE card for the number of  $k_{eff}$  cycles to be skipped before  $k_{eff}$  and tally accumulation. After the first  $I_c$  cycles, the fission source spatial distribution is assumed to have achieved equilibrium, active cycles begin, and  $k_{eff}$  and tallies are accumulated. Cycles are run until either a time limit is reached or the total cycles on the KCODE card have been completed.

### **B. Estimation of $k_{eff}$ Confidence Intervals and Prompt Neutron Lifetimes**

The criticality eigenvalue  $k_{eff}$  and various prompt neutron lifetimes, along with their standard deviations, are automatically estimated in every criticality calculation in addition to any user-requested tallies.  $k_{eff}$  and the lifetimes are estimated for every active cycle, as well as averaged over all active cycles.  $k_{eff}$  and the lifetimes are estimated in three different ways. These estimates are combined<sup>105</sup> using observed statistical correlations to provide the optimum final estimate of  $k_{eff}$  and its standard deviation.

It is known<sup>107</sup> that the power iteration method with a fixed source size produces a very small negative bias  $\Delta k_{eff}$  in  $k_{eff}$  that is proportional to  $1/N$ . This bias is negligible<sup>107</sup> for all practical problems where  $N$  is greater than about 200 neutrons per cycle and as long as too many active cycles are not used. It has been shown<sup>107</sup> that this bias is less, probably much less, than one-half of one standard deviation for 400 active cycles when the ratio of the true  $k_{eff}$  standard deviation to  $k_{eff}$  is 0.0025 at the problem end.

In MCNP the definition of  $k_{eff}$  is:

$$k_{eff} = \frac{\text{fission neutrons in generation } i+1}{\text{fission neutrons in generation } i}$$

$$= \frac{\rho_a \int_V \int_0^\infty \int_E \int_\Omega v \sigma_f \Phi dV dt dE d\Omega}{\int_V \int_0^\infty \int_E \int_\Omega \nabla \cdot J dV dt dE d\Omega + \rho_a \int_V \int_0^\infty \int_E \int_\Omega (\sigma_c + \sigma_f + \sigma_m) \Phi dV dt dE d\Omega}$$

where the phase-space variables are  $t$ ,  $E$ , and  $\Omega$  for time, energy, direction, and implicitly  $r$  for position with incremental volume  $dV$  around  $r$ . The denominator is the loss rate, which is the sum of leakage, capture (n,0n), fission, and multiplicity (n,xn) terms. By particle balance, the loss rate is also the source rate, which is unity in a criticality calculation. If the number of fission neutrons

produced in one generation is equal to the number in the previous generation, then the system is critical. If it is greater, the system is supercritical. If it is less, then the system is subcritical. The multiplicity term is:

$$\begin{aligned} & \rho_a \int_V \int_0^\infty \int_E \int_\Omega \sigma_m \Phi(dV dt) dE d\Omega \\ &= \rho_a \int_V \int_0^\infty \int_E \int_\Omega \sigma_{n, 2n} \Phi dV dt dE d\Omega - 2\rho_a \int_V \int_0^\infty \int_E \int_\Omega \sigma_{n, 2n} \Phi dV dt dE d\Omega \\ &+ \rho_a \int_V \int_0^\infty \int_E \int_\Omega \sigma_{n, 3n} \Phi dV dt dE d\Omega - 3\rho_a \int_V \int_0^\infty \int_E \int_\Omega \sigma_{n, 3n} \Phi dV dt dE d\Omega + \dots \end{aligned}$$

The above definition of  $k_{eff}$  comes directly from the time-integrated Boltzmann transport equation (without external sources):

$$\begin{aligned} & \int_V \int_0^\infty \int_E \int_\Omega \nabla \cdot J dV dt dE d\Omega + \rho_a \int_V \int_0^\infty \int_E \int_\Omega \sigma_T \Phi dV dt dE d\Omega \\ &= \frac{1}{k_{eff}} \rho_a \int_V \int_0^\infty \int_E \int_\Omega v \sigma_f \Phi dV dt dE d\Omega + \rho_a \int_V \int_0^\infty \int_E \int_\Omega \int_{E'} \sigma'_s \Phi' dE' dV dt dE d\Omega \end{aligned}$$

which may be rewritten to look more like the definition of  $k_{eff}$  as:

$$\begin{aligned} & \int_V \int_0^\infty \int_E \int_\Omega \nabla \cdot J dV dt dE d\Omega \\ &+ \rho_a \int_V \int_0^\infty \int_E \int_\Omega (\sigma_c + \sigma_f + \sigma_{n, 2n} + \sigma_{n, 3n} + \dots) \Phi dV dt dE d\Omega \\ &= \frac{1}{k_{eff}} \rho_a \int_V \int_0^\infty \int_E \int_\Omega v \sigma_f \Phi dV dt dE d\Omega \\ &+ \rho_a \int_V \int_0^\infty \int_E \int_\Omega (2\sigma_{n, 2n} + 3\sigma_{n, 3n} + \dots) \Phi dV dt dE d\Omega \end{aligned}$$

The loss rate is on the left and the production rate is on the right.

The neutron prompt removal lifetime is the average time from the emission of a prompt neutron in fission to the removal of the neutron by some physical process such as escape, capture, or fission. In MCNP “absorption” and “capture” are used interchangeably, both meaning (n,0n), and  $\sigma_c$  and  $\sigma_a$  are used interchangeably. Also, even with the TOTNU card to produce delayed neutrons as well as prompt neutrons (KCODE default), the neutrons are all born at time zero, so

## CHAPTER 2 CRITICALITY CALCULATIONS

the removal lifetimes calculated in MCNP are prompt removal lifetimes, even if there are delayed neutrons.

The definition of the prompt removal lifetime<sup>108</sup> is

$$\tau_r = \frac{\int_V \int_0^\infty \int_E \int_\Omega \eta dV dt dE d\Omega}{\int_V \int_0^\infty \int_E \int_\Omega \nabla \cdot J dV dt dE d\Omega + \rho_a \int_V \int_0^\infty \int_E \int_\Omega (\sigma_c + \sigma_f + \sigma_m) \Phi dV dt dE d\Omega} ,$$

where  $\eta$  is the population per unit volume per unit energy per unit solid angle. In a multiplying system in which the population is increasing or decreasing on an asymptotic period, the population changes in accordance with

$$\eta = \eta_0 e^{(k_{eff} - 1)t/\tau_r^+} ,$$

where  $\tau_r$  is the adjoint-weighted removal lifetime. MCNP calculates the nonadjoint-weighted prompt removal lifetime  $\tau_r$  that can be significantly different in a multiplying system. In a nonmultiplying system,  $k_{eff} = 0$  and  $\tau_r \rightarrow \tau_r^+$ , the population decays as

$$\eta = \eta_0 e^{-t/\tau_r} ,$$

where the nonadjoint-weighted removal lifetime  $\tau_r$  is also the relaxation time.

Noting that the flux is defined as

$$\Phi = \eta v ,$$

where  $v$  is the speed, the MCNP nonadjoint-weighted prompt removal lifetime  $\tau_r$  is defined as

$$\tau_r = \frac{\int_V \int_0^\infty \int_E \int_\Omega \frac{\Phi}{v} dV dt dE d\Omega}{\int_V \int_0^\infty \int_E \int_\Omega \nabla \cdot J dV dt dE d\Omega + \rho_a \int_V \int_0^\infty \int_E \int_\Omega (\sigma_c + \sigma_f + \sigma_m) \Phi dV dt dE d\Omega} .$$

The prompt removal lifetime is a fundamental quantity in the nuclear engineering point kinetics equation. It is also useful in nuclear well-logging calculations and other pulsed source problems because it gives the population time-decay constant.

### 1. Collision Estimators

The collision estimate for  $k_{eff}$  for any active cycle is:

$$k_{eff}^C = \frac{1}{N} \sum_i W_i \left[ \frac{\sum_k f_k \bar{v}_k \sigma_{f_k}}{\sum_k f_k \sigma_{T_k}} \right] ,$$

where  $i$  is summed over all collisions in a cycle where fission is possible;  
 $k$  is summed over all nuclides of the material involved in the  $i^{\text{th}}$  collision;  
 $\sigma_{T_k}$  = total microscopic cross section;  
 $\sigma_{f_k}$  = microscopic fission cross section;  
 $\bar{v}_k$  = average number of prompt or total neutrons produced per fission by the collision nuclide at the incident energy;  
 $f_k$  = atomic fraction for nuclide  $k$ ;  
 $N$  = nominal source size for cycle; and  
 $W_i$  = weight of particle entering collision.

Because  $W_i$  represents the number of neutrons entering the  $i^{\text{th}}$  collision,

$$W_i \left[ \frac{\sum_k f_k \bar{v}_k \sigma_{f_k}}{\sum_k f_k \sigma_{T_k}} \right]$$

is the expected number of neutrons to be produced from all fission processes in the collision. Thus  $k_{eff}^C$  is the mean number of fission neutrons produced per cycle. The collision estimator tends to be best, sometimes only marginally so, in very large systems.

The collision estimate of the prompt removal lifetime for any active cycle is the average time required for a fission source neutron to be removed from the system by either escape, capture (n,0n), or fission.

$$\tau_r^C = \frac{\sum W_e T_e + \sum (W_c + W_f) T_x}{\sum W_e + \sum (W_c + W_f)} ,$$

where  $T_e$  and  $T_x$  are the times from the birth of the neutron until escape or collision.  $W_e$  is the weight lost at each escape.  $W_c + W_f$  is the weight lost to (n,0n) and fission at each collision,

$$W_c + W_f = W_i \frac{\sum_k f_k (\sigma_{c_k} + \sigma_{f_k})}{\sum_k f_k \sigma_{T_k}} ,$$

where  $\sigma_{c_k}$  is the microscopic capture (n,0n) cross section, and  $W_i$  is the weight entering the collision.

## CHAPTER 2 CRITICALITY CALCULATIONS

### 2. Absorption Estimators

The absorption estimator for  $k_{eff}$  for any active cycle is made when a neutron interacts with a fissionable nuclide. The estimator differs for analog and implicit capture. For analog capture,

$$k_{eff}^A = \frac{1}{N} \sum_i W_i \bar{v}_k \frac{\sigma_{f_k}}{\sigma_{c_k} + \sigma_{f_k}} ,$$

where  $i$  is summed over each analog capture event in the  $k^{th}$  nuclide. Note that in analog capture, the weight is the same both before and after the collision. Because analog capture includes fission in criticality calculations, the frequency of analog capture at each collision with nuclide  $k$  is  $(\sigma_{c_k} + \sigma_{f_k})/\sigma_{T_k}$ . The analog absorption  $k_{eff}$  estimate is very similar to the collision estimator of  $k_{eff}$  except that only the  $k^{th}$  absorbing nuclide, as sampled in the collision, is used rather than averaging over all nuclides.

For implicit capture, the following is accumulated:

$$k_{eff}^A = \frac{1}{N} \sum_i W_i' \bar{v}_k \frac{\sigma_{f_k}}{\sigma_{c_k} + \sigma_{f_k}} ,$$

where  $i$  is summed over all collisions in which fission is possible and  $W_i' = W_i(\sigma_{c_k} + \sigma_{f_k})/\sigma_{T_k}$  is the weight absorbed in the implicit capture. The difference between the implicit absorption estimator  $k_{eff}^A$  and the collision estimator  $k_{eff}^C$  is that only the nuclide involved in the collision is used for the absorption  $k_{eff}$  estimate rather than an average of all nuclides in the material for the collision  $k_{eff}$  estimator.

The absorption estimator with analog capture is likely to produce the smallest statistical uncertainty of the three for systems where the ratio  $\bar{v}_k \sigma_{f_k} / (\sigma_{c_k} + \sigma_{f_k})$  is nearly constant. Such would be the case for a thermal system with a dominant fissile nuclide such that the 1/velocity cross section variation would tend to cancel.

The absorption estimate differs from the collision estimate in that the collision estimate is based upon the expected value at each collision, whereas the absorption estimate is based upon the events actually sampled at a collision. Thus all collisions will contribute to the collision estimate of  $k_{eff}^C$  and  $\tau_r^C$  by the probability of fission (or capture for  $\tau_r^C$ ) in the material. Contributions to the absorption estimator will only occur if an actual fission (or capture for  $\tau_r^A$ ) event occurs for the sampled nuclide in the case of analog capture. For implicit capture, the contribution to the absorption estimate will only be made for the nuclide sampled.

The absorption estimate of the prompt removal lifetime for any active cycle is again the average time required for a fission source neutron to be removed from the system by either escape, capture (n,0n), or fission.

For implicit capture,

$$\tau_r^A = \frac{\sum W_e T_e + \sum (W_c T_c + W_f T_f) T_x}{\sum W_e + \sum W_c + \sum W_f},$$

where

$$W_c + W_f = \frac{W_i \sigma_{c_k} + \sigma_{f_k}}{\sigma_{T_k}}.$$

For analog capture,

$$\tau_r^A = \frac{\sum W_e T_e + \sum W_c T_c + \sum W_f T_f}{\sum W_e + \sum W_c + \sum W_f},$$

where  $T_e$ ,  $T_c$ ,  $T_f$ , and  $T_x$  are the times from the birth of the neutron until escape, capture (n,0n), fission, or collision.  $W_e$  is the weight lost at each escape.  $W_c$  and  $W_f$  are the weights lost to capture (n,0n) and fission at each capture (n,0n) or fission event with the nuclide sampled for the collision.

### 3. Track Length Estimators

The track length estimator of  $k_{eff}$  is accumulated every time the neutron traverses a distance  $d$  in a fissionable material cell:

$$k_{eff}^{TL} = \frac{1}{N} \sum_i W_i \rho d \sum_k f_k \bar{v}_k \sigma_{f_k},$$

where  $i$  is summed over all neutron trajectories,  
 $\rho$  is the atomic density in the cell, and  
 $d$  is the trajectory track length from the last event.

Because  $\rho d \sum_k f_k \bar{v}_k \sigma_{f_k}$  is the expected number of fission neutrons produced along trajectory  $d$ ,  $k_{eff}^{TL}$  is a third estimate of the mean number of fission neutrons produced in a cycle per nominal fission source neutron.

The track length estimator tends to display the lowest variance for optically thin fuel cells (e.g., plates) and fast systems where large cross-section variations because of resonances may cause high variances in the other two estimators.

## CHAPTER 2 CRITICALITY CALCULATIONS

The track length estimator for the prompt removal lifetime for each cycle is accumulated every time the neutron traverses a distance  $d$  in any material in any cell:

$$\tau_r^{TL} = \frac{\sum_i W_i d/v}{W_s} ,$$

where  $W_s$  is the source weight summed over all histories in the cycle and  $v$  is the velocity. Note that  $d/v$  is the time span of the track. Note further that:

$$\sum_i W_i d/v = \rho_a \int_V \int_0^\infty \int_E \int_\Omega \frac{\Phi}{v} dV dt dE d\Omega ,$$

and in criticality problems:

$$\begin{aligned} W_s &= \frac{1}{k_{eff}} \rho_a \int_V \int_0^\infty \int_E \int_\Omega v \sigma_f \Phi dV dt dE d\Omega \\ &= \int_V \int_0^\infty \int_E \int_\Omega \nabla \cdot J dV dt dE d\Omega + \rho_a \int_V \int_0^\infty \int_E \int_\Omega (\sigma_c + \sigma_f + \sigma_m) \Phi dV dt dE d\Omega \end{aligned}$$

These relationships show how  $\tau_r^{TL}$  is related to the definition of  $\tau_r$  on page 2-164.

### 4. Other Lifetime Estimators

In addition to the collision, absorption, and track length estimators of the prompt removal lifetime  $\tau_r$ , MCNP provides the escape, capture (n,0n), and fission prompt lifespans and lifetimes for all KCODE problems having a sufficient number of settle cycles. Further, the “average time of” printed in the problem summary table is related to the lifespans, and track-length estimates of many lifetimes can be computed using the  $l/v$  tally multiplier option on the FM card for track-length tallies.

In KCODE problems, MCNP calculates the lifespan of escape  $l_e$ , capture (n,0n)  $l_c$ , fission  $l_f$ , and removal  $l_r$ :

$$\begin{aligned} l_e &= \frac{\sum W_e T_e}{\sum W_e} , \\ l_c &= \frac{\sum W_c T_c}{\sum W_c} , \\ l_f &= \frac{\sum W_f T_f}{\sum W_f} , \quad \text{and} \end{aligned}$$

$$l_r = \frac{\Sigma W_e T_e + \Sigma W_c T_c + \Sigma W_f T_f}{\Sigma W_e + \Sigma W_c + \Sigma W_f} .$$

These sums are taken over all the active histories in the calculation. (If KC8 = 0 on the KCODE card, then the sums are over both active and inactive cycle histories, but KC8 = 1, the default, is assumed for the remainder of this discussion.) The capture (n,0n) and fission contributions are accumulated at each collision with a nuclide, so these are absorption estimates. Thus,

$$l_r \approx \tau_r^A .$$

The difference is that  $\tau_r^A$  is the average of the  $\tau_r^A$  for each cycle and  $l_r$  is the average over all histories.  $l_r = \tau_r^A$  if there is precisely one active cycle, but then neither  $\tau_r^A$  nor  $l_r$  is printed out because there are too few cycles. The cycle average  $\tau_r^A$  does not precisely equal the history average  $l_r$  because they are ratios.

$l_e$  and  $l_c$  are the “average time to” escape and capture (n,0n) that is printed in the problem summary table for all neutron and photon problems.

$\frac{1}{N}\Sigma W_e$ ,  $\frac{1}{N}\Sigma W_c$ , and  $\frac{1}{N}\Sigma W_f$  are the weight lost to escape, capture (n,0n), and fission in the problem summary table.

The “fractions”  $F_x$  printed out below the lifespan in the KCODE summary table are, for x = e, c, f, or r,

$$F_x = \frac{W_x}{\Sigma W_e + \Sigma W_c + \Sigma W_f} .$$

The prompt lifetimes<sup>108</sup> for the various reactions  $\tau_x$  are then

$$\tau_x = \frac{\tau_r}{F_x} = \rho_a \frac{\int_V \int_0^\infty \frac{\Phi}{v} dV dt}{\int_V \int_0^\infty \sigma_x \Phi dV dt} .$$

Both  $\tau_r^A$  and the covariance-weighted combined estimator  $\tau_r^{(C/A/T)}$  are used. Note again that the slight differences between similar quantities are because  $l_x$  and  $F_x$  are averaged over all active histories whereas  $\tau_r^A$  and  $\tau_r^{(C/A/T)}$  are averaged within each active cycle, and then the final values are the averages of the cycle values, i.e., history-averages vs. batch-averages.

The prompt removal lifetime can also be calculated using the F4 track-length tally with the  $l/v$  multiplier option on the FM card and using the volume divided by the average source weight  $W_s$  as the multiplicative constant. The standard track length tally is then converted from



## CHAPTER 2 CRITICALITY CALCULATIONS

$$F4 = \int \Phi dt \quad \text{to}$$

$$F4 = \frac{V}{W_s} \int \frac{\Phi}{v} dt \quad .$$

Remember to multiply by volume, either by setting the FM card constant to the volume or overriding the F4 volume divide by using segment divisors of unity on the SD card.  $W_s$  should be unity for KCODE calculations. The only difference between  $\tau_r^{TL}$  and the modified F4 tally will be any variations from unity in  $W_s$  and the error estimation, which will be batch-averaged for  $\tau_r^{TL}$  and history-averaged for the F4 tally.

Lifetimes for all other processes also can be estimated by using the FM multiplier to calculate reaction rates as well (the numerator and denominator are separate tallies that must be divided by the user — see the examples in Chapter 4 and 5):

$$\tau_x^{TL} = \frac{(1/v \text{ multiplier})}{\text{reaction rate multiplier}} = \rho_a \frac{\int_V \int_0^\infty \frac{\Phi}{v} dV dt}{\int_V \int_0^\infty \sigma_x \Phi dV dt} \quad .$$

Note that the lifetimes are inversely additive:

$$\frac{1}{\tau_r} = \frac{1}{\tau_e} + \frac{1}{\tau_c} + \frac{1}{\tau_f} \quad .$$

### 5. Combined $k_{eff}$ and $\tau_r$ Estimators

MCNP provides a number of combined  $k_{eff}$  and  $\tau_r$  estimators that are combinations of the three individual  $k_{eff}$  and  $\tau_r$  estimators using two at a time or all three. The combined  $k_{eff}$ 's and  $\tau_r$ 's are computed by using a maximum likelihood estimate, as outlined by Halperin<sup>109</sup> and discussed further by Urbatsch.<sup>105</sup> This technique, which is a generalization of the inverse variance weighting for uncorrelated estimators, produces the maximum likelihood estimate for the combined average  $k_{eff}$  and  $\tau_r$ , which, for multivariate normality, is the almost–minimum variance estimate. It is “almost” because the covariance matrix is not known exactly and must be estimated. The three-combined  $k_{eff}$  and  $\tau_r$  estimators are the best final estimates from an MCNP calculation.<sup>105</sup>

This method of combining estimators can exhibit one feature that is disconcerting: sometimes (usually with highly positively correlated estimators) the combined estimate will lie outside the interval defined by the two or three individual average estimates. Statisticians at Los Alamos have shown<sup>105</sup> that this is the best estimate to use for a final  $k_{eff}$  and  $\tau_r$  value. Reference 105 shows the results of one study of 500 samples from three highly positively correlated normal

distributions, all with a mean of zero. In 319 samples, all three estimators fell on the same side of the expected value. This type of behavior occurs with high positive correlation because if one estimator is above or below the expected value, the others have a good probability of being on the same side of the expected value. The advantage of the three-combined estimator is that the Halperin algorithm correctly predicts that the true value will lie outside of the range.

### 6. Error Estimation and Estimator Combination

After the first  $I_c$  inactive cycles, during which the fission source spatial distribution is allowed to come into spatial equilibrium, MCNP begins to accumulate the estimates of  $k_{eff}$  and  $\tau_r$  with those estimates from previous active (after the inactive) cycles. The relative error  $R$  of each quantity is estimated in the usual way as

$$R = \frac{1}{\bar{x}} \sqrt{\frac{x^2 - \bar{x}^2}{M-1}}$$

where  $M$  = the number of active cycles,

$$\bar{x} = \frac{1}{M} \sum_m x_m, \quad \text{and} \quad \overline{x^2} = \frac{1}{M} \sum_m x_m^2,$$

where  $x_m$  = a quantity, such as  $k_{eff}^C$ , from cycle  $m$ . This assumes that the cycle-to-cycle estimates of each  $k_{eff}$  are uncorrelated. This assumption generally is good for  $k_{eff}$ , but not for the eigenfunction (fluxes) of optically large systems.<sup>110</sup>

MCNP also combines the three estimators in all possible ways and determines the covariance and correlations. The simple average of two estimators is defined as  $x^{ij} = (1/2)(x^i + x^j)$ , where, for example,  $x^i$  may be the collision estimator  $k_{eff}^C$  and  $x^j$  may be the absorption estimator  $k_{eff}^A$ .

The “combined average” of two estimators is weighted by the covariances as

$$x^{ij} = x^i - \frac{(x^i - x^j)(C_{ii} - C_{ij})}{(C_{ii} + C_{jj} - 2C_{ij})} = \frac{(C_{jj} - C_{ij})x^i + (C_{ii} - C_{ij})x^j}{(C_{ii} + C_{jj} - 2C_{ij})},$$

where the covariance  $C_{ij}$  is

$$C_{ij} = \frac{1}{m} \sum_m x_m^i x_m^j - \left( \frac{1}{M} \sum_m x_m^i \right) \left( \frac{1}{M} \sum_m x_m^j \right).$$

Note that  $C_{ii} = \overline{x^2} - \bar{x}^2$  for estimator  $i$ .

## CHAPTER 2 CRITICALITY CALCULATIONS

The “correlation” between two estimators is a function of their covariances and is given by

$$\text{correlation} = \frac{C_{ij}}{\sqrt{|C_{ii}C_{jj}|}} .$$

The correlation will be between unity (perfect positive correlation) and minus one (perfect anti or negative correlation). If the correlation is one, no new information has been gained by the second estimator. If the correlation is zero, the two estimators appear statistically independent and the combined estimated standard deviation should be significantly less than either. If the correlation is negative one, even more information is available because the second estimator will tend to be low, relative to the expected value, when the first estimator is high and vice versa. Even larger improvements in the combined standard deviation should occur.

The combined average estimator ( $k_{eff}$  or  $\tau_r$ ) and the estimated standard deviation of all three estimators are based on the method of Halperin<sup>109</sup> and is much more complicated than the two-combination case. The improvements to the standard deviation of the three-combined estimator will depend on the magnitude and sign of the correlations as discussed above. The details and analysis of this method are given in Ref. 105.

For many problems, all three estimators are positively correlated. The correlation will depend on what variance reduction (e.g., implicit or analog capture) is used. Occasionally, the absorption estimator may be only weakly correlated with either the collision or track length estimator. It is possible for the absorption estimator to be significantly anticorrelated with the other two estimators for some fast reactor compositions and large thermal systems. Except in the most heterogeneous systems, the collision and track length estimators are likely to be strongly positively correlated.

There may be a negative bias<sup>107</sup> in the estimated standard deviation of  $k_{eff}$  for systems with dominance ratios (second largest to largest eigenvalue) close to unity. These systems are typically large with small neutron leakage. The magnitude of this effect can be estimated by batching the cycle  $k_{eff}$  values in batch sizes much greater than one cycle,<sup>107</sup> which MCNP provides automatically. For problems where there is a reason to suspect the results, a more accurate calculation of this effect can be done by making several independent calculations of the same problem (using different random number sequences) and observing the variance of the population of independent  $k_{eff}$ 's. The larger the number of independent calculations that can be made, the better the distribution of  $k_{eff}$  values can be assessed.

### 7. Creating and Interpreting $k_{eff}$ Confidence Intervals

The result of a Monte Carlo criticality calculation (or any other type of Monte Carlo calculation) is a confidence interval. For criticality, this means that the result is not just  $k_{eff}$ , but  $k_{eff}$  plus and minus some number of estimated standard deviations to form a confidence interval (based on the

Central Limit Theorem) in which the true answer is expected to lie a certain fraction of the time. The number of standard deviations used (e.g., from a Student's t Table) determines the fraction of the time that the confidence interval will include the true answer, for a selected confidence level. For example, a valid 99% confidence interval should include the true result 99% of the time. There is always some probability (in this example, 1%) that the true result will lie outside of the confidence interval. To reduce this probability to an acceptable level, either the confidence interval must be increased according to the desired Student's t percentile, or more histories need to be run to get a smaller estimated standard deviation.

MCNP uses three different estimators for  $k_{eff}$ . The advantages of each estimator vary with the problem: no one estimator will be the best for all problems. All estimators and their estimated standard deviations are valid under the assumption that they are unbiased and consistent, therefore representative of the true parameters of the population. This statement has been validated empirically<sup>105</sup> for all MCNP estimators for small dominance ratios. The batched  $k_{eff}$  results table should be used to estimate if the calculated batch-size-of-one  $k_{eff}$  standard deviation appears to be adequate.

**The confidence interval based on the three-statistically-combined  $k_{eff}$  estimator is the recommended result to use for all final  $k_{eff}$  confidence interval quotations** because all of the available information has been used in the final result. This estimator often has a lower estimated standard deviation than any of the three individual estimators and therefore provides the smallest valid confidence interval as well. The final estimated  $k_{eff}$  value, estimated standard deviation, and the estimated 68%, 95%, and 99% confidence intervals (using the correct number of degrees of freedom) are presented in the box on the  $k_{eff}$  results summary page of the output. If other confidence intervals are wanted, they can be formed from the estimated standard deviation of  $k_{eff}$ . At least 30 active cycles need to be run for the final  $k_{eff}$  results box to appear. Thirty cycles are required so that there are enough degrees of freedom to form confidence intervals using the well-known estimated standard deviation multipliers. (When constructing a confidence interval using any single  $k_{eff}$  estimator, its standard deviation, and a Student's t Table, there are  $I_t - I_c - 1$  degrees of freedom. For the two- and three-combined  $k_{eff}$  estimators, there are  $I_t - I_c - 2$  and  $I_t - I_c - 3$  degrees of freedom, respectively.)

All of the  $k_{eff}$  estimators and combinations by two or three are provided in MCNP so that the user can make an alternate choice of confidence interval if desired. Based on statistical studies, using the individual  $k_{eff}$  estimator with the smallest estimated standard deviation is not recommended. Its use can lead to confidence intervals that do not include the true result the correct fraction of the time.<sup>105</sup> The studies have shown that the standard deviation of the three-combined  $k_{eff}$  estimator provides the correct coverage rates, assuming that the estimated standard deviations in the individual  $k_{eff}$  estimators are accurate. This accuracy can be verified by checking the batched  $k_{eff}$  results table. When significant anti-correlations occur among the estimators, the resultant much smaller estimated standard deviation of the three-combined average has been verified<sup>105</sup> by analyzing a number of independent criticality calculations.

## CHAPTER 2 CRITICALITY CALCULATIONS

### 8. Analysis to Assess the Validity of a Criticality Calculation

The two most important requirements for producing a valid criticality calculation for a specified geometry are sampling all of the fissionable material well and ensuring that the fundamental spatial mode was achieved before and maintained during the active  $k_{eff}$  cycles. MCNP has checks to assess the fulfillment of both of these conditions.

MCNP verifies that at least one fission source point was generated in each cell containing fissionable material. A WARNING message is printed on the  $k_{eff}$  results summary page that includes a list of cells that did not have any particles entering, and/or no collisions, and/or no fission source points. For repeated structures geometries, a source point in any one cell that is repeated will satisfy this test. For example, assume a problem with a cylinder and a cube that are both filled with the same universe, namely a sphere of uranium and the space outside the sphere. If a source point is placed in the sphere inside the cylinder but not in the sphere inside the cube, the test will be satisfied.

One basic assumption that is made for a good criticality calculation is that the normal spatial mode for the fission source has been achieved after  $I_c$  cycles were skipped. MCNP attempts to assess this condition in several ways. The estimated combined  $k_{eff}$  and its estimated standard deviation for the first and second active cycle halves of the problem are compared. A WARNING message is issued if either the difference of the two values of combined col/abs/track-length  $k_{eff}$  does not appear to be zero or the ratio of the larger-to-the-smaller estimated standard deviations of the two col/abs/track-length  $k_{eff}$  is larger than expected. Failure of either or both checks implies that the two active halves of the problem do not appear to be the same and the output from the calculation should be inspected carefully.

MCNP checks to determine which number of cycles skipped produces the minimum estimated standard deviation for the combined  $k_{eff}$  estimator. If this number is larger than  $I_c$ , it may indicate that not enough inactive cycles were skipped. The table of combined  $k_{eff}$ -by-number-of-cycles skipped should be examined to determine if enough inactive cycles were skipped.

It is assumed that  $N$  is large enough so that the collection of active cycle  $k_{eff}$  estimates for each estimator will be normally distributed if the fundamental spatial mode has been achieved in  $I_c$  cycles and maintained for the rest of the calculation. To test this assumption, MCNP performs normality checks<sup>111,112</sup> on each of the three  $k_{eff}$  estimator cycle data at the 95% and 99% confidence levels. A WARNING message is issued if an individual  $k_{eff}$  data set does not appear to be normally distributed at the 99% confidence level. This condition will happen to good data about 1% of the time. Unless there is a high positive correlation among the three estimators, it is expected to be rare that all three  $k_{eff}$  estimators will not appear normally distributed at the 99% confidence level when the normal spatial mode has been achieved and maintained. When the condition that all three sets of  $k_{eff}$  estimators do not appear to be normal at the 99% confidence level occurs, the box with the final  $k_{eff}$  will not be printed. The final confidence interval results

are available elsewhere in the output. Examine the calculation carefully to see if the normal mode was achieved before the active cycles began. The normality checks are also made for the batched- $k_{eff}$  and  $k_{eff}$ -by-cycles-skipped tables so that normality behavior can be studied by batch size and  $I_c$ .

These normality checks test the assumption that the individual cycle  $k_{eff}$  values behave in the assumed way. Even if the underlying individual cycle  $k_{eff}$  values are not normally distributed, the three *average*  $k_{eff}$  values and the combined  $k_{eff}$  estimator will be normally distributed if the conditions required by the Central Limit Theorem are met for the average. If required, this assumption can be tested by making several independent calculations to verify empirically that the population of average  $k_{eff}$ 's appears to be normally distributed with the same population variance as estimated by MCNP.

MCNP tests for a monotonic trend of the three-combined  $k_{eff}$  estimator over the last ten active cycles. This type of behavior is not expected in a well converged solution for  $k_{eff}$  and could indicate a problem with achieving or maintaining the normal spatial mode. A WARNING message is printed if such a monotonic trend is observed.

### 9. Normalization of Standard Tallies in a Criticality Calculation

Track length fluxes, surface currents, surface fluxes, heating and detectors—all the standard MCNP tallies—can be made during a criticality calculation. The tallies are for one fission neutron generation. Biases may exist in these criticality results, but appear to be smaller than statistical uncertainties.<sup>107</sup> These tallied quantities are accumulated only after the  $I_c$  inactive cycles are finished. The tally normalization is per active source weight  $w$ , where  $w = N * (I_t - I_c)$ , and  $N$  is the nominal source size (from the KCODE card);  $I_t$  is the total number of cycles in the problem; and  $I_c$  is the number of inactive cycles (from KCODE card). The number  $w$  is appropriately adjusted if the last cycle is only partially completed. If the tally normalization flag (on the KCODE card) is turned on, the tally normalization is the actual number of starting particles during the active cycles rather than the nominal weight above. Bear in mind, however, that the source particle weights are all set to  $W = N/M$  so that the source normalization is based upon the nominal source size  $N$  for each cycle.

An MCNP tally in a criticality calculation is for one fission neutron being born in the system at the start of a cycle. The tally results must be scaled either by the total number of neutrons in a burst or by the neutron birth rate to produce, respectively, either the total result or the result per unit time of the source. The scaling factor is entered on the Fm card.

The statistical errors that are calculated for the tallies assume that all the neutron histories are independent. They are not independent because of the cycle-to-cycle correlations that become worse as the dominance ratio approaches one. In this limit, each  $k_{eff}$  cycle effectively provides no new source information. For extremely large systems (dominance ratio  $\geq 0.995$ ), the

## CHAPTER 2 CRITICALITY CALCULATIONS

estimated standard deviation for a tally that involves only a portion of the problem could be underestimated by a factor of five or more (see Ref. 110, page 42–44). This value also is a function of the size of the tally region. In the Ref. 110 slab reactor example, the entire problem (i.e.,  $k_{eff}$ ) standard deviation was not underestimated at all. An MCNP study<sup>113</sup> of the FFTF fast reactor with a smaller dominance ratio indicates that 90% coverage rates for flux tallies are good, but that 2 out of 300 tallies were beyond four estimated standard deviations. Independent runs can be made to study the real eigenfunction distribution (i.e., tallies) and the estimated standard deviations for difficult criticality calculations. This method is the only way to determine accurately these confidence intervals for large dominance ratio problems.

### 10. Neutron Tallies and the MCNP Net Multiplication Factor

The MCNP net multiplication factor  $M$  printed out on the problem summary page differs from the  $k_{eff}$  from the criticality code. We will examine a simple model to illustrate the approximate relationship between these quantities and compare the tallies between standard and criticality calculations.

Assume we run a standard MCNP calculation using a fixed neutron source distribution identical in space and energy to the source distribution obtained from the solution of an eigenvalue problem with  $k_{eff} < 1$ . Each generation will have the same space and energy distribution as the source. The contribution to an estimate of any quantity from one generation is reduced by a factor of  $k_{eff}$  from the contribution in the preceding generation. The estimate  $E_k$  of a tally quantity obtained in a criticality eigenvalue calculation is the contribution for one generation produced by a unit source of fission neutrons. An estimate for a standard MCNP fixed source calculation,  $E_s$ , is the sum of contributions for all generations starting from a unit source.

$$E_s = E_k + k_{eff}E_k + k_{eff}^2E_k + k_{eff}^3E_k + \dots = E_k / (1 - k_{eff}) \quad . \quad (2.26)$$

Note that  $1/(1 - k_{eff})$  is the true system multiplication. The above result depends on our assumptions about the unit fission source used in the standard MCNP run. Usually,  $E_s$  will vary considerably from the above result, depending on the difference between the fixed source and the eigenmode source generated in the eigenvalue problem.  $E_s$  will be a fairly good estimate if the fixed source is a distributed source roughly approximating the eigenmode source. Tallies from a criticality calculation are appropriate only for a critical system and the tally results can be scaled to a desired fission neutron source (power) level or total neutron pulse strength.

In a fixed source MCNP problem, the net multiplication  $M$  is defined to be unity plus the gain  $G_f$  in neutrons from fission plus the gain  $G_x$  from nonfission multiplicative reactions. Using neutron weight balance (creation equals loss),

$$M = 1 + G_f + G_x = W_e + W_c \quad , \quad (2.27)$$

## CHAPTER 2 CRITICALITY CALCULATIONS

where  $W_e$  is the weight of neutrons escaped per source neutron and  $W_c$  is the weight of neutrons captured per source neutron. In a criticality calculation, fission is treated as an absorptive process; the corresponding relationship for the net multiplication is then

$$M^o = 1 + G_x^o = W_e^o + W_c^o + W_f^o \quad , \quad (2.28)$$

where the superscript  $o$  designates results from the criticality calculation and  $W_f^o$  is the weight of neutrons causing fission per source neutron. Because  $k_{eff}$  is the number of fission neutrons produced in a generation per source neutron, we can also write

$$k_{eff} = \bar{\nu} W_f^o \quad , \quad (2.29)$$

where  $\bar{\nu}$  is the average number of neutrons emitted per fission for the entire problem. Making the same assumptions as above for the fixed source used in the standard MCNP calculation and using equations (2.26), (2.27), and (2.28), we obtain

$$M = W_e + W_c = \frac{W_e^o + W_c^o}{1 - k_{eff}} = \frac{M^o - W_f^o}{1 - k_{eff}}$$

or, by using (2.28) and (2.29),

$$M = \frac{M^o - \frac{k_{eff}}{\bar{\nu}}}{1 - k_{eff}} = \frac{1 - \frac{k_{eff}}{\bar{\nu}} + G_x^o}{1 - k_{eff}} \quad .$$

Often, the nonfission multiplicative reactions  $G_x^o \ll 1$ . This implies that  $k_{eff}$  can be **approximated** by  $k_{eff}^{FS}$  (from an appropriate **Fixed Source** calculation)

$$k_{eff} \approx k_{eff}^{FS} = \frac{M - 1}{M - \frac{1}{\bar{\nu}}} \quad , \quad (2.30)$$

**when the two fission neutron source distributions are nearly the same.** The average value of  $\bar{\nu}$  in a problem can be calculated by dividing the fission neutrons gained by the fission neutrons lost as given in the totals of the neutron weight balance for physical events. Note, however, that the above estimate is subject to the same limitations as described in Eq. 2.26.



## CHAPTER 2 CRITICALITY CALCULATIONS

### C. *Recommendations for Making a Good Criticality Calculation*

#### 1. Problem Set-Up

As with any calculation, the geometry must be adequately and correctly specified to represent the true physical situation. Plot the geometry and check cells, materials, and masses for correctness. Specify the appropriate nuclear data, including  $S(\alpha,\beta)$  thermal data, at the correct material temperatures. Do as good a job as possible to put initial fission source points in every cell with fissionable material. Try running short problems with both analog and implicit capture (see the PHYS:N card) to improve the figure of merit for the combined  $k_{eff}$  and any tallies being made. Follow the tips for good calculations listed at the end of Chapter 1.

#### 2. Number of Neutrons per Cycle and Number of Cycles

Criticality calculations can suffer from two potential problems. The first is the failure to sufficiently converge the spatial distribution of the fission source from its initial guess to a distribution fluctuating around the fundamental eigenmode solution. It is recommended that you make an initial run with a relatively small number of source particles per generation (perhaps 500) and generously allow a large enough number of cycles so that the eigenvalue appears to be fluctuating about a constant value. You should examine the results and continue the calculation if any trends in the eigenvalue are noticeable. The SRCTP file from the last  $k_{eff}$  cycle of the initial run can then be used as the source for the final production run to be made with a larger number of histories per cycle.

This convergence procedure can be extended for very slowly convergent problems—typically large, thermal, low-leakage systems, where a convergence run might be made with 500 histories per cycle. Then a second convergence run would be made with 1000 histories per cycle, using the SRCTP file from the first run as an initial fission source guess. If the results from the second run appear satisfactory, then a final run might be made using 4000 particles per cycle with the SRCTP file from the second run as an initial fission source guess. In the final run, only a few cycles should need to be skipped. The bottom line is this: skip enough cycles so that the normal spatial mode is achieved.

The second potential problem arises from the fact that the criticality algorithm produces a very small negative bias in the estimated eigenvalue. The bias depends upon  $1/N$ , where  $N$  is the number of source particles per generation. Thus it is desirable to make  $N$  as large as possible. Any value of  $N > 200$  should be sufficient to reduce the bias to a small level. The eigenvalue bias  $\Delta k_{eff}$  has been shown<sup>107</sup> to be

$$-\Delta k_{eff} = \frac{(I_t - I_c)}{2k_{eff}} (\sigma_{k_{eff}}^2 - \sigma_{approx}^2) \quad , \quad (2.31)$$

where  $\sigma_{k_{eff}}$  is the true standard deviation for the final  $k_{eff}$ ,  
 $\sigma_{approx}$  is the approximate standard deviation computed assuming  
the individual  $k_{eff}$  values are statistically independent, and  
 $\sigma_{k_{eff}}^2 > \sigma_{approx}^2$ .

The standard deviations are computed at the end of the problem. Because the  $\sigma^2$ s decrease as  $1/(I_t - I_c)$ ,  $\Delta k_{eff}$  is independent of the number of active cycles. Recall that  $\Delta k_{eff}$  is proportional to  $1/N$ , the number of neutrons per  $k_{eff}$  cycle.

Eqn. (2.31) can be written<sup>107</sup> as the following inequality:

$$\frac{|\Delta k_{eff}|}{\sigma k_{eff}} < \frac{(I_t - I_c)\sigma_{k_{eff}}}{2k_{eff}} \quad (2.32)$$

This inequality is useful for determining an upper limit to the number of active cycles that should be used for a calculation without having  $\Delta k_{eff}$  dominate  $\sigma_{k_{eff}}$ . If  $\sigma_{k_{eff}}/k_{eff}$  is 0.0025, which is a reasonable value for criticality calculations, and  $I_t - I_c$  is 400, then  $|\Delta k_{eff}|/\sigma_{k_{eff}} < 0.5$  and  $\Delta k_{eff}$  will not dominate the  $k_{eff}$  confidence interval. If  $\sigma_{k_{eff}}$  is reasonably well approximated by MCNP's estimated standard deviation, this ratio will be much less than 0.5.

The total running time for the active cycles is proportional to  $N(I_t - I_c)$ , and the standard deviation in the estimated eigenvalue is proportional to  $1/\sqrt{N(I_t - I_c)}$ . From the results of the convergence run, the total number of histories needed to achieve the desired standard deviation can be estimated.

It is recommended that 200 to 400 active cycles be used, assuming that the above  $|\Delta k_{eff}|/\sigma_{k_{eff}}$  is much less than unity in doing so. This large number of cycles will provide large batch sizes of  $k_{eff}$  cycles (e.g., 40 batches of 10 cycles each for 400 active cycles) to compare estimated standard deviations with those obtained for a batch size of one  $k_{eff}$  cycle. For example, for 400 active cycles, 40 batches of 10  $k_{eff}$ s are created and analyzed for a new average  $k_{eff}$  and a new estimated standard deviation. The behavior of the average  $k_{eff}$  by a larger number of cycles can also be observed to ensure a good normal spatial mode. Fewer than 30 active cycles is not recommended because trends in the average  $k_{eff}$  may not have enough cycles to develop.

### 3. Analysis of Criticality Problem Results

The goal of the calculation is to produce a  $k_{eff}$  confidence interval that includes the true result the desired fraction of the time. Check all WARNING messages. Understand their significance to

## CHAPTER 2 CRITICALITY CALCULATIONS

the calculation. Study the results of the checks that MCNP makes that were described starting on page 2-174.

The criticality problem output contains a lot of useful information. Study it to make sure that: 1) the problem terminated properly; 2) enough cycles were skipped to ensure that the normal spatial mode for fission sources was achieved; 3) all cells with fissionable material were sampled; 4) the average combined  $k_{eff}$  appears to be varying randomly about the average value for the active cycles; 5) the average combined  $k_{eff}$ -by-cycles-skipped does not exhibit a trend during the latter stages of the calculation; 6) the confidence intervals for the batched (with at least 30 batch values) combined  $k_{eff}$  do not differ significantly from the final result; 7) the impact of having the largest of each of the three  $k_{eff}$  estimators occurring on the next cycle is not too great on the final confidence interval; and 8) the combined  $k_{eff}$  figure of merit should be stable. The combined  $k_{eff}$  figure of merit should be reasonably stable, but not as stable as a tally figure of merit because the number of histories for each cycle is not exactly the same and combined  $k_{eff}$  relative error may experience some changes because of changes in the estimated covariance matrix for the three individual estimators.

Plots (using the z option) can be made of the three individual and average  $k_{eff}$  estimators by cycle, as well as the three-estimator-combined  $k_{eff}$ . Use these plots to better understand the results.

If there is concern about a calculation, the  $k_{eff}$ -by-cycles-skipped table presents the results that would be obtained in the final result box for differing numbers of cycles skipped. This information can provide insight into fission source spatial convergence, normality of the  $k_{eff}$  data sets, and changes in the 95% and 99% confidence intervals. If concern persists, a problem could be run that tallies the track length estimator  $k_{eff}$  using an F4:n tally and an FM card using the -6 and -7 reaction multipliers (see Chapter 4 for an example). In the most drastic cases, several independent calculations can be made and the variance of the  $k_{eff}$  values (and any other tallies) could be computed from the individual values.

If a conservative (too large)  $k_{eff}$  confidence interval is desired, the results from the largest  $k_{eff}$  occurring on the next cycle table can be used. This situation could occur with a maximum probability of  $1/(I_t - I_c)$  for highly positively correlated  $k_{eff}$ 's to  $1/(I_t - I_c)^3$  for no correlation.

Finally, keep in mind the discussion in starting on page 2-175. For large systems with a dominance ratio close to one, the estimated standard deviations for tallies could be much smaller than the true standard deviation. The cycle-to-cycle correlations in the fission sources are not taken into account, especially for any tallies that are not made over the entire problem. The only way to obtain the correct statistical errors in this situation is to run a series of independent problems using different random number sequences and analyze the sampled tally results to estimate the statistical uncertainties.

## ***IX. VOLUMES AND AREAS<sup>114</sup>***

The particle flux in Monte Carlo transport problems often is estimated as the track length per unit volume or the number of particles crossing a surface per unit area. Therefore, knowing the volumes and surface areas of the geometric regions in a Monte Carlo problem is essential. Knowing volumes is useful in calculating the masses and densities of cells and thus in calculating volumetric or mass heating. Furthermore, calculation of the mass of a geometry is frequently a good check on the accuracy of the geometry setup when the mass is known by other means.

Calculating volumes and surface areas in modern Monte Carlo transport codes is nontrivial. MCNP allows the construction of cells from unions and/or intersections of regions defined by an arbitrary combination of second-degree surfaces, toroidal fourth-degree surfaces, or both. These surfaces can have different orientations or be segmented for tallying purposes. The cells they form even can consist of several disjoint subcells. Cells can be constructed from quadrilateral or hexagonal lattices or can be embedded in repeated structures universes. Although such generality greatly increases the flexibility of MCNP, computing cell volumes and surface areas understandably requires increasingly elaborate computational methods.

MCNP automatically calculates volumes and areas of polyhedral cells and of cells or surfaces generated by surfaces of revolution about any axis, even a skew axis. If a tally is segmented, the segment volumes or areas are computed. For nonrotationally symmetric or nonpolyhedral cells, a stochastic volume and surface area method that uses ray tracing is available. See page 2–182.

### ***A. Rotationally Symmetric Volumes and Areas***

The procedure for computing volumes and surface areas of rotationally symmetric bodies follows:

1. Determine the common axis of symmetry of the cell.<sup>114</sup> If there is none and if the cell is not a polyhedron, MCNP cannot compute the volume (except stochastically) and the area of each bounding surface cannot be computed on the side of the asymmetric cell.
2. Convert the bounding surfaces to q-form:

$$ar^2 + br + cs^2 + ds + e = 0 \quad ,$$

where  $s$  is the axis of rotational symmetry in the  $r$ - $s$  coordinate system. All MCNP surfaces except tori are quadratic surfaces and therefore can be put into q-form.

3. Determine all intersections of the bounding surfaces with each other in the  $r$ - $s$  coordinate system. This procedure generally requires the solution of a quartic equation.<sup>22</sup> For spheres, ellipses, and tori, extra intersection points are added so that

**CHAPTER 2**  
**VOLUMES AND AREAS<sup>114</sup>**

these surfaces are not infinite. The list of intersections are put in order of increasing s-coordinate. If no intersection is found, the surface is infinite; its volume and area on one side cannot be computed.

4. Integrate over each bounding surface segment between intersections:

$$V = \pi \int r^2 ds \quad \text{for volumes;}$$

$$A = 2\pi \int r \sqrt{1 + \left(\frac{dr}{ds}\right)^2} ds \quad \text{for surface areas.}$$

A bounding surface segment lies between two intersections that bound the cell of interest.

A numerical integration is required for the area of a torroidal surface; all other integrals are directly solved by integration formulas. The sense of a bounding surface to a cell determines the sign of  $V$ . The area of each surface is determined cell-by-cell twice, once for each side of the surface. An area will be calculated unless bounded on both sides by asymmetric or infinite cells.

**B. Polyhedron Volumes and Areas**

A polyhedron is a body bounded only by planes that can have an arbitrary orientation. The procedure for calculating the volumes and surface areas of polyhedra is as follows:

1. For each facet side (planar surface), determine the intersections  $(r_i, s_i)$  of the other bounding planes in the  $r$ - $s$  coordinate system. The  $r$ - $s$  coordinate system is redefined for each facet to be an arbitrary coordinate system in the plane of the facet.
2. Determine the area of the facet:

$$a = \frac{1}{2} \sum (s_{i+1} - s_i)(r_{i+1} + r_i) \quad ,$$

and the coordinates of its centroid,  $r_c, s_c$ :

$$r_c = 1/(6a) \sum (s_{i+1} - s_i)(r_{i+1}^2 + r_{i+1}r_i + r_i^2) \quad .$$

$$s_c = 1/(6a) \sum (r_{i+1} - r_i)(s_{i+1}^2 + s_{i+1}s_i + s_i^2) \quad .$$

The sums are over all bounding edges of the facet where  $i$  and  $i + 1$  are the ends of the bounding edge such that, in going from  $i$  to  $i + 1$ , the facet is on the right side. As with rotationally symmetric cells, the area of a surface is determined cell-by-cell twice, once for each side. The area of a surface on one side is the sum over all facets on that side.

3. The volume of a polyhedron is computed by using an arbitrary reference plane. Prisms are projected from each facet normal to the reference plane, and the volume of each prism is  $V = da \cos \theta$  where

$d$  = distance from reference plane to facet centroid;

$a$  = facet area; and

$\theta$  = angle between the external normal of the facet and the positive normal of the reference plane.

The sum of the prism volumes is the polyhedron cell volume.

### C. *Stochastic Volume and Area Calculation*

MCNP cannot calculate the volumes and areas of asymmetric, nonpolyhedral, or infinite cells. Also, in very rare cases, the volume and area calculation can fail because of roundoff errors. For these cases a stochastic estimation is possible by ray tracing. The procedure is as follows:

1. Void out all materials in the problem (VOID card).
2. Set all nonzero importances to one and all positive weight windows to zero.
3. Use a planar source with a source weight equal to the surface area to flood the geometry with particles. This will cause the particle flux throughout the geometry to statistically approach unity. Perhaps the best way to do a stochastic volume estimation is to use an inward-directed, biased cosine source on a spherical surface with weight equal to  $\pi r^2$ .
4. Use the cell flux tally (F4) to tabulate volumes and the surface flux tally (F2) to tabulate areas. The cell flux tally is inversely proportional to cell volume. Thus in cells whose volumes are known, the unit flux will result in a tally of unity and in cells whose volume is uncalculated, the unit flux will result in a tally of volumes. Similarly, the surface flux tally is inversely proportional to area so that the unit flux will result in a tally of unity wherever the area is known and a tally of area wherever it is unknown.

## X. *PLOTTER*

The MCNP plotter draws cross-sectional views of the problem geometry according to commands entered by the user. See Appendix B for the command vocabulary and examples of use. The pictures can be drawn on the screen of a terminal or on some local or remote hard copy graphics device, as directed by the user. The pictures are drawn in a square viewport on the graphics device. The mapping between the viewport and the portion of the problem space to be plotted, called the window, is user-defined. A plane in problem space, the plot plane, is defined by specifying an origin  $\vec{r}_o$  and two perpendicular basis vectors  $\vec{a}$  and  $\vec{b}$ . The size of the window in the plot plane is defined by specifying two extents. The picture appears in the viewport with

## CHAPTER 2 PLOTTER

the origin at the center, the first basis vector pointing to the right and the second basis vector pointing up. The width of the picture is twice the first extent and the height is twice the second extent. If the extents are unequal, the picture is distorted. The central task of the plotter is to plot curves representing the intersections of the surfaces of the geometry with the plot plane within the window.

All plotted curves are conics, defined here to include straight lines. The intersection of a plane with any MCNP surface that is not a torus is always a conic. A torus is plotted only if the plot plane contains the torus axis or is perpendicular to it, in which cases the intersection curves are conics. The first step in plotting the curves is to find equations for them, starting from the equations for the surfaces of the problem. Equations are needed in two forms for each curve: a quadratic equation and a pair of parametric equations. The quadratic equations are needed to solve for the intersections of the curves. The parametric equations are needed for defining the points on the portions of the curves that are actually plotted.

The equation of a conic is

$$As^2 + 2Hst + Bt^2 + 2Gs + 2Ft + C = 0 \quad ,$$

where  $s$  and  $t$  are coordinates in the plot plane. They are related to problem coordinates  $(x,y,z)$  by

$$\vec{r} = \vec{r}_o + s\vec{a} + t\vec{b}$$

or in matrix form

$$\begin{bmatrix} 1 \\ x \\ y \\ z \end{bmatrix} = \begin{bmatrix} 1 & 0 & 0 \\ x_o & a_x & b_x \\ y_o & a_y & b_y \\ z_o & a_z & b_z \end{bmatrix} \begin{bmatrix} 1 \\ s \\ t \end{bmatrix} \text{ or } \begin{bmatrix} 1 \\ x \\ y \\ z \end{bmatrix} = PL \begin{bmatrix} 1 \\ s \\ t \end{bmatrix} \quad .$$

In matrix form the conic equation is

$$[1 \ s \ t] \begin{bmatrix} C & G & F \\ G & A & H \\ F & H & B \end{bmatrix} \begin{bmatrix} 1 \\ s \\ t \end{bmatrix} = 0 \text{ or } [1 \ s \ t] QM \begin{bmatrix} 1 \\ s \\ t \end{bmatrix} \quad .$$

Thus, finding the equation of a curve to be plotted is a matter of finding the  $QM$  matrix, given the  $PL$  matrix and the coefficients of the surface.

Any surface in MCNP, if it is not a torus, can be readily written as

$$Ax^2 + By^2 + Cz^2 + Dxy + Eyz + Fzx + Gx + Hy + Jz + K = 0 \quad ,$$

or in matrix form as

$$[1 \ x \ y \ z] \begin{bmatrix} K & G/2 & H/2 & J/2 \\ G/2 & A & D/2 & F/2 \\ H/2 & D/2 & B & E/2 \\ J/2 & F/2 & E/2 & C \end{bmatrix} \begin{bmatrix} 1 \\ x \\ y \\ z \end{bmatrix} = 0 \quad ,$$

or

$$[1 \ x \ y \ z] AM \begin{bmatrix} 1 \\ x \\ y \\ z \end{bmatrix} = 0 \quad .$$

The transpose of the transformation between  $(s,t)$  and  $(x,y,z)$  is

$$[1 \ x \ y \ z] = [1 \ s \ t] PL^T \quad ,$$

where  $PL^T$  is the transpose of the  $PL$  matrix. Substitution in the surface equation gives

$$[1 \ s \ t] PL^T AM PL \begin{bmatrix} 1 \\ s \\ t \end{bmatrix} = 0 \quad .$$

Therefore,  $QM = PL^T AM PL$ .

A convenient set of parametric equations for conics is

straight line	s	=	$C_1 + C_2p$
	t	=	$C_4 + C_5p$
parabola	s	=	$C_1 + C_2p + C_3p^2$
	t	=	$C_4 + C_5p + C_6p^2$
ellipse	s	=	$C_1 + C_2 \sin p + C_3 \cos p$
	t	=	$C_4 + C_5 \sin p + C_6 \cos p$
hyperbola	s	=	$C_1 + C_2 \sinh p + C_3 \cosh p$
	t	=	$C_4 + C_5 \sinh p + C_6 \cosh p$ .



## CHAPTER 2 PLOTTER

The type of a conic is determined by examination of the conic invariants,<sup>115</sup> which are simple functions of the elements of  $QM$ . Some of the surfaces produce two curves, such as the two branches of a hyperbola or two straight lines. A separate set of parametric coefficients,  $C_1$  through  $C_6$ , is needed for each curve in such cases. The parametric coefficients are found by transforming  $QM$  into yet another coordinate system where most of its elements are zero. The parametric coefficients are then simple functions<sup>115</sup> of the remaining elements. Finally, the coefficients are transformed from that coordinate system back to the  $(s,t)$  system.

For a plottable torus, the curves are either a pair of identical ellipses or a pair of concentric circles. The parametric coefficients are readily calculated from the surface coefficients and the elements of  $QM$  are simple functions of the parametric coefficients.

The next step is to reject all curves that lie entirely outside the window by finding the intersections of each curve with the straight line segments that bound the window, taking into account the possibility that an ellipse may lie entirely inside the window.

The remaining curves are plotted one at a time. The intersections of the current curve with all of the other remaining curves and with the boundaries of the window are found by solving the simultaneous equations

$$[1 \ s \ t] QM_i \begin{bmatrix} 1 \\ s \\ t \end{bmatrix} = 0 \quad ,$$

where  $i = 1$  is the current curve and  $i = 2$  is one of the other curves. This process generally requires finding the roots of a quartic. False roots and roots outside the window are rejected and the value of the parameter  $p$  for each remaining intersection is found. The intersections then are arranged in order of increasing values of  $p$ .

Each segment of the curve—the portion of the curve between two adjacent intersections—is examined to see whether and how it should be plotted. A point near the center of the segment is transformed back to the  $(x,y,z)$  coordinate system. All cells immediately adjacent to the surface at that point are found. If there is exactly one cell on each side of the surface and those cells are the same, the segment is not plotted. If there is exactly one cell on each side and those cells are different, the segment is plotted as a solid line. If anything else is found, the segment is plotted as a dotted line, which indicates either that there is an error in the problem geometry or that some other surface of the problem also intersects the plot plane along the segment.

If a curve to be plotted is not a straight line, it is plotted as a sequence of short straight lines between selected points on the curve. The points are selected according to the criterion that the middle of the line drawn between points must not lie farther from the nearest point on the true

curve than the nominal resolution of the picture. The nominal resolution is fixed at 1/3000 of a side of the viewport. This is a bit coarse for the best plotting devices and is quite a bit too fine for the worst ones, but it produces adequate pictures at reasonable cost.

## ***XI. PSEUDORANDOM NUMBERS***

Like any other Monte Carlo program, MCNP uses a sequence of pseudorandom numbers to sample from probability distributions. MCNP has always used the congruential scheme of Lehmer,<sup>15</sup> though the mechanics of implementation have been modified for portability to different computer platforms. In particular, a method has been devised that multiplies two 64-bit words to get a 128-bit word without using more than 64-bit words for the 128-bit word.<sup>116</sup>

A pseudorandom sequence of integers  $I_n$  is generated by

$$I_{n+1} = \text{mod}(M I_n, 2^{48}) \quad ,$$

where  $M$  is the random number multiplier, and 48-bit integers and 48-bit floating point mantissas are assumed. The default value of  $M$ , which can be changed with the DBCN card, is

$$M = 5^{19} = 19,073,486,328,125 \quad .$$

The pseudorandom number is then

$$R_n = 2^{-48} I_n \quad .$$

The starting pseudorandom number of each history is

$$I_{n+S} = \text{mod}(M^S I_n, 2^{48}) \quad ,$$

where  $S$  is the pseudorandom number stride. Because each pseudorandom number is the least significant (lower) 48 bits of  $M$  multiplied by the previous random number, the lower 48 bits of  $I_{n+S}$  are the same as the lower 48 bits of  $M^S I_n$ . The default value of  $S$ , which can be changed with the DBCN card, is

$$S = 152917_{10} = 452525_8 = 1001010101010101_2 \quad .$$

The 01010101 pattern ensures that the bit pattern will change when the stride is multiplied by almost anything.

The period  $P$  of the MCNP algorithm is

$$P = 2^{46} \approx 7.04 \times 10^{13}$$

## CHAPTER 2 PERTURBATIONS

because the last two binary bits of the lower 48 bits of  $M^k$  are  $01_2$  for all values of  $k$ . The period could be increased from  $2^{46}$  to

$$P = 2^{48} \approx 2.81 \times 10^{14}$$

by adding 1 as follows:

$$I_n = \text{mod}(M I_{n-1}, 2^{48}) + 1 \quad .$$

MCNP prints a WARNING and counts the number of histories for which the stride  $S$  is exceeded. MCNP also prints a WARNING if the period  $P$  is exceeded. Exceeding the stride or the period does not result in wrong answers but does result in an underestimate of the variance. However, because the random numbers are used for very different purposes, MCNP seems quite insensitive to overrunning either the stride or the period.<sup>116</sup>

Sometimes users wish to know how much of the variation between problems is purely statistical and the variance is insufficient to provide this information. In correlated sampling (see page 2–158) and criticality problems, the variances can be underestimated because of correlation between histories. In this case, rerun the problems with a different random number sequence, either by starting with a new random number or by changing the random number stride or multiplier on the DBCN card. MCNP checks for and does not allow invalid choices, such as an even numbered initial random number that, after a few pseudorandom numbers, would result in all subsequent random numbers being zero.

### ***XII. PERTURBATIONS***

The evaluation of response or tally sensitivities to cross-section data involves finding the ratio of the change in a tally to the infinitesimal change in the data, as given by the Taylor series expansion. In deterministic methods, this ratio is approximated by performing two calculations, one with the original data and one with the perturbed data. This approach is useful even when the magnitude of the perturbation becomes very small. In Monte Carlo methods, however, this approach fails as the magnitude of the perturbation becomes small because of the uncertainty associated with the response. For this reason, the differential operator technique was developed.

The differential operator perturbation technique as applied in the Monte Carlo method was introduced by Olhoeft<sup>117</sup> in the early 1960's. Nearly a decade after its introduction, this technique was applied to geometric perturbations by Takahashi.<sup>118</sup> A decade later, the method was generalized for perturbations in cross-section data by Hall<sup>119,120</sup> and later Rief.<sup>121</sup> A rudimentary implementation into MCNP followed shortly thereafter.<sup>122</sup> With an enhancement of the user interface and the addition of second order effects, this implementation has evolved into a standard MCNP feature.

**A. Derivation of the Operator**

In the differential operator approach, a change in the Monte Carlo response  $c$ , due to changes in a related data set (represented by the parameter  $v$ ), is given by a Taylor series expansion

$$\Delta c = \frac{dc}{dv} \cdot \Delta v + \frac{1}{2!} \cdot \frac{d^2c}{dv^2} \cdot \Delta v^2 + \dots + \frac{1}{n!} \cdot \frac{d^n c}{dv^n} \cdot \Delta v^n + \dots \quad ,$$

where the  $n^{\text{th}}$  order coefficient is

$$u_n = \frac{1}{n!} \cdot \frac{d^n c}{dv^n} \quad .$$

This can be written as

$$u_n = \frac{1}{n!} \sum_{b \in B} \sum_{h \in H} x_b^n(h) \left( \frac{\partial^n c}{\partial x_b^n(h)} \right) \quad ,$$

for the data set

$$x_b(h) = K k_b(h) \cdot e^v; b \in B, h \in H \quad ,$$

where  $K k_b(h)$  is some constant,  $B$  represents a set of macroscopic cross sections, and  $H$  represents a set of energies or an energy interval.

For a track-based response estimator

$$c = \sum_j t_j q_j \quad ,$$

where  $t_j$  is the response estimator and  $q_j$  is the probability of path segment  $j$  (path segment  $j$  is comprised of segment  $j - 1$  plus the current track.) This gives

$$u_n = \frac{1}{n!} \sum_j \left[ \sum_{b \in B} \sum_{h \in H} x_b^n(h) \left( \frac{\partial^n}{\partial x_b^n(h)} (t_j q_j) \right) \right] \quad ,$$

or

**CHAPTER 2  
PERTURBATIONS**

$$u_n = \frac{1}{n!} \sum_j \gamma_{nj} t_j q_j \quad ,$$

where

$$\gamma_{nj} \equiv \sum_{b \in B} \sum_{h \in H} x_b^n(h) \left( \frac{\partial^n}{\partial x_b^n(h)} (t_j q_j) \right) \left( \frac{1}{t_j q_j} \right) \quad .$$

With some manipulations presented in Ref. 123, the path segment estimator  $\gamma_{nj} t_j$  can be converted to a particle history estimator of the form

$$u_n \sum_i V_{ni} p_i \quad ,$$

where  $p_i$  is the probability of the  $i^{\text{th}}$  history and  $V_{ni}$  is the  $n^{\text{th}}$  order coefficient estimator for history  $i$ , given by

$$V_{ni} \equiv \frac{1}{n!} \sum_j \gamma_{nj} t_j \quad .$$

Note that this sum involves only those path segments  $j'$  in particle history  $i$ . The Monte Carlo expected value of  $u_n$  becomes

$$\begin{aligned} \langle u_n \rangle &= \frac{1}{N} \sum_i V_{ni} \\ &= \frac{1}{N n!} \sum_i \left( \sum_{j'} \gamma_{nj'} t_{j'} \right) \quad , \end{aligned}$$

for a sample of  $N$  particle histories.

The probability of path segment  $j$  is the product of the track probabilities,

$$q_j = \prod_{k=0}^m r_k \quad ,$$

where  $r_k$  is the probability of track  $k$  and segment  $j$  contains  $m + 1$  tracks. If the  $k^{\text{th}}$  track starts with a neutron undergoing reaction type “a” at energy  $E'$  and is scattered from angle  $\theta'$  to angle  $\theta$  and  $E$ , continues for a length  $\lambda_k$ , and collides, then

$$r_k = \left( \frac{x_a(E')}{x_T(E')} \right) P_a(E' \rightarrow E; \theta' \rightarrow \theta) dE d\tau \theta (e^{-x_T(E)\lambda_k}) x_T(E) d\lambda \quad ,$$

where  $x_a(E')$  is the macroscopic reaction cross section at energy  $E'$ ,  $x_T(E')$  is the total cross section at energy  $E'$ , and  $P_a(E' \rightarrow E; \theta' \rightarrow \theta) dE d\theta$  is the probability distribution function in phase space of the emerging neutron. If the track starts with a collision and ends in a boundary crossing

$$r_k = \left( \frac{x_a(E')}{x_T(E')} \right) P_a(E' \rightarrow E; \theta' \rightarrow \theta) dE d\theta (e^{-x_T(E)\lambda_k}) \quad .$$

If the track starts with a boundary crossing and ends with a collision,

$$r_k = (e^{-x_T(E)\lambda_k}) x_T(E) d\lambda$$

And finally, if the track starts and ends with boundary crossings

$$r_k = e^{-x_T(E)\lambda_k}$$

### 1. First Order

For a first order perturbation, the differential operator becomes

$$\begin{aligned} \gamma_{1j'} &\equiv \sum_{b \in B} \sum_{h \in H} x_b(h) \left( \frac{\partial}{\partial x_b(h)} (t_{j'} q_{j'}) \right) \left( \frac{1}{t_{j'} q_{j'}} \right) \\ &= \sum_{b \in B} \sum_{h \in H} \left( \frac{x_b(h)}{q_{j'}} \frac{\partial q_{j'}}{\partial x_b(h)} + \frac{x_b(h)}{t_{j'}} \frac{\partial t_{j'}}{\partial x_b(h)} \right) \end{aligned}$$

whereas,

$$\frac{1}{q_{j'}} \frac{\partial q_{j'}}{\partial x_b(h)} = \sum_{k=0}^m \frac{1}{r_k} \frac{\partial r_k}{\partial x_b(h)} .$$

then

$$\lambda_{1j'} = \sum_{k=0}^m \beta_{jk} + R_{1j'} \quad ,$$

## CHAPTER 2 PERTURBATIONS

where

$$\beta_{j'k} \equiv \sum_{b \in B} \sum_{h \in H} \left( \frac{x_b(h)}{r_k} \right) \left( \frac{\partial r_k}{\partial x_b(h)} \right)$$

$$= \sum_{b \in B} \sum_{h \in H} \left( \delta_{hE} \delta_{ba} - \frac{\delta_{hE} x_b(E')}{x_T(E')} - \delta_{hE} x_b(E) \lambda_k + \frac{\delta_{hE} x_b(E)}{x_T(E)} \right)$$

for a track segment k that starts with a particle undergoing reaction type “a” at energy  $E'$  and is scattered to energy  $E$  and collides after a distance  $\lambda_k$ . Note that  $\delta_{hE}$  and  $\delta_{ba}$  are unity if  $h=E$  and  $b=a$ ; otherwise they vanish. For other types of tracks (for which the various expressions for  $r_k$  were given in the previous section), i.e., collision to boundary, boundary to collision, and boundary to boundary, derivatives of  $r_k$  can be taken leading to one or more of these four terms for  $\beta_{j'k}$ .

The second term of  $\gamma_{Ij}$  is

$$R_{1j'} = \sum_{b \in B} \sum_{h \in H} \frac{x_b(h)}{t_j} \frac{\partial t_j}{\partial x_b(h)} ,$$

where the tally response is a linear function of some combination of reaction cross sections, or

$$t_j = \lambda_k \sum_{c \in C} x_c(E) ,$$

where  $c$  is an element of the tally cross sections,  $c \in C$ , and may be an element of the perturbed cross sections,  $c \in B$ . Then,

$$R_{1j'} = \sum_{b \in B} \sum_{h \in H} \frac{x_b(h)}{\left( \sum_{c \in C} x_c(h) \right)} \frac{\partial}{\partial x_b(h)} \left( \sum_{c \in C} x_c(h) \right)$$

$$= \frac{\sum_{c \in B} \sum_{E \in H} x_c(E)}{\sum_{c \in C} x_c(E)} .$$

$R_{Ij}$  is the fraction of the reaction rate tally involved in the perturbation. If none of the nuclides participating in the tally is involved in the perturbation, then  $R_{Ij} = 0$ , which is always the case for F1, F2, and F4 tallies without FM cards. For F4 tallies with an FM card, if the FM card multiplicative constant is positive (no flag to multiply by atom density) it is assumed that the FM

tally cross sections are unaffected by the perturbation and  $R_{1j'} = 0$ . For KCODE  $k_{eff}$  track length estimates, F6 and F7 heating tallies, and F4 tallies with FM cards with negative multipliers (multiply by atom density to get macroscopic cross sections), if the tally cross section is affected by the perturbation, then  $R_{1j'} > 0$ . For  $k_{eff}$  and F6 and F7 tallies in perturbed cells where all nuclides are perturbed, generally  $R_{1j'} = 1$ .

Finally, the expected value of the first order coefficient is

$$\langle u_1 \rangle = \frac{1}{N} \sum_i \left[ \sum_{j'} \left( \sum_{k=0}^m \beta_{j'k} + R_{1j'} \right) t_{j'} \right] .$$

## 2. Second Order

For a second order perturbation, the differential operator becomes

$$\begin{aligned} \gamma_{2j'} &\equiv \sum_{b \in B} \sum_{h \in H} x_b^2(h) \left( \frac{\partial^2}{\partial x_b^2(h)} (t_{j'} q_{j'}) \right) \left( \frac{1}{t_{j'} q_{j'}} \right) \\ &= \sum_{b \in B} \sum_{h \in H} \frac{x_b^2(h)}{t_{j'} q_{j'}} \left( t_{j'} \frac{\partial^2 q_{j'}}{\partial x_b^2(h)} \right) + 2 \frac{\partial q_{j'}}{\partial x_b(h)} \frac{\partial t_{j'}}{\partial x_b(h)} + q_{j'} \frac{\partial^2 t_{j'}}{\partial x_b^2(h)} . \end{aligned}$$

Whereas  $t_{j'}$  is a linear function of  $x_{b(h)}$ , then

$$\frac{\partial^2 t_{j'}}{\partial x_b^2(h)} = 0$$

and by taking first and second derivatives of the  $r_k$  terms of  $q_{j'}$  as for the first order perturbation,

$$\gamma_{2j'} = \sum_{k=0}^m (\alpha_{j'k} - \beta_{j'k}^2) - R_{1j'}^2 + \left( \sum_{k=0}^m \beta_{j'k} + R_{1j'} \right)^2 ,$$

where

$$\alpha_{j'k} = \sum_{b \in B} \sum_{h \in H} \left( \frac{2 \delta_{hE'} x_b^2(E')}{x_T^2(E')} - \frac{2 \delta_{hE'} \delta_{ba} x_b(E')}{x_T(E')} + \delta_{hE} x_b^2 \lambda_k^2 - \frac{2 \delta_{hE} x_b^2(E) \lambda_k}{x_T(E)} \right) .$$

The expected value of the second order coefficient is



**CHAPTER 2  
PERTURBATIONS**

$$\langle u_2 \rangle = \frac{1}{2N} \sum_i \left[ \sum_{j'} \left( \sum_{k=0}^m (\alpha_{j'k} - \beta_{j'k}^2) - R_{1j'}^2 + \left( \sum_{k=0}^m \beta_{j'k} + R_{1j'} \right)^2 \right) t_{j'} \right] ,$$

where  $\beta_{j'k}$  and  $\alpha_{j'k}$  are given by one or more terms as described above for track  $k$  and  $R_{1j'}$  is again the fraction of the perturbation with nuclides participating in the tally.

**3. Implementation in MCNP**

The total perturbation printed in the MCNP output file is

$$\langle \Delta c \rangle = \frac{1}{N} \sum_i \sum_{j'} \Delta c_{j'} .$$

For each history  $i$  and path  $j'$ ,

$$\Delta c_{j'} = \frac{dc_{j'}}{dv} \cdot \Delta v + \frac{1}{2} \cdot \frac{d^2c_{j'}}{dv^2} \cdot \Delta v^2 .$$

Let the first order perturbation with  $R_{1j'} = 0$  be

$$P_{1j'} = \sum_{j'} \left( \sum_{k=0}^m \beta_{j'k}^2 \right) t_{j'} ,$$

and let the second order perturbation with  $R_{1j'} = 0$  be

$$P_{2j'} = \sum_{j'} \left( \sum_{k=0}^m (\alpha_{j'k} - \beta_{j'k}^2) \right) t_{j'} .$$

Then the Taylor series expansion for  $R_{1j'} = 0$  is

$$\Delta c_{j'} = \left( P_{1j'} \Delta v + \frac{1}{2} (P_{2j'} + P_{1j'}^2) \Delta v^2 \right) t_{j'} .$$

If  $R_{1j'} \neq 0$  then

$$\Delta c_{j'} = \left[ (P_{1j'} + R_{1j'}) \Delta v + \frac{1}{2} (P_{2j'} - R_{1j'}^2 + (P_{1j'} + R_{1j'})^2) \Delta v^2 \right] t_{j'}$$

$$= \left[ P_{1j'} \Delta v + \frac{1}{2} (P_{2j'} + P_{1j'}^2) \Delta v^2 + R_{1j'} \Delta v + P_{1j'} R_{1j'} \Delta v^2 \right] t_{j'} \quad .$$

That is, the  $R_{1j'} \neq 0$  case is just a correction to the  $R_{1j'} = 0$  case.

In MCNP,  $P_{1j'}$  and  $P_{2j'}$  are accumulated along every track length through a perturbed cell. All perturbed tallies are multiplied by

$$P_{1j'} \Delta v + \frac{1}{2} (P_{2j'} + P_{1j'}^2) \Delta v^2$$

and then if  $R_{1j'} \neq 0$  the tally is further corrected by

$$R_{1j'} \Delta v + P_{1j'} R_{1j'} \Delta v^2 \quad .$$

$R_{1j'}$  is the fraction of the reaction rate tally involved in the perturbation.  $R_{1j'} = 0$  for F1, F2, F4 tallies without FM cards, and F4 tallies with FM cards with positive multiplicative constants.

### **B. Limitations**

Although it is always a high priority to minimize the limitations of any MCNP feature, the perturbation technique has the limitations given below. Chapter 3, page 3–144, has examples you can refer to.

1. A fatal error is generated if a PERT card attempts to unvoid a region. The simple solution is to include the material in the unperturbed problem and void the region of interest with the PERT card. See Appendix B of Ref. 124.
2. A fatal error is generated if a PERT card attempts to alter a material composition in such a way as to introduce a new nuclide. The solution is to set up the unperturbed problem with a mixture of both materials and introduce PERT cards to remove each. See Appendix B of Ref. 124.
3. The track length estimate of  $k_{eff}$  in KCODE criticality calculations assumes the fundamental eigenvector (fission distribution) is unchanged in the perturbed configuration.
4. DXTRAN, point detector tallies, and pulse height tallies are not currently compatible with the PERT card.
5. While there is no limit to the number of perturbations, they should be kept to a minimum, as each perturbation can degrade performance by 10–20%.
6. The METHOD keywork can indicate if a perturbation is so large that higher than second order terms are needed to prevent inaccurate tallies.

## CHAPTER 2 PERTURBATIONS

### *C. Accuracy*

Analyzing the first and second order perturbation results presented in Ref. 124 leads to the following rules of thumb. The first order perturbation estimator typically provides sufficient accuracy for response or tally changes that are less than 5%. The default first and second order estimator offers acceptable accuracy for response changes that are less than 20–30%. This upper bound depends on the behavior of the response as a function of the perturbed parameter. The magnitude of the second order estimator is a good measure of the range of applicability. If this magnitude exceeds 30% of the first order estimator, it is likely that higher order terms are needed for an accurate prediction. The METHOD keyword on the PERT card allows one to tally the second order term separate from the first. See Chapter 3, page 3–142.

***XIII. REFERENCES***

1. L. L. Carter and E. D. Cashwell, *Particle Transport Simulation with the Monte Carlo Method*, ERDA Critical Review Series, TID-26607 (1975).
2. Ivan Lux and Laszlo Koblinger, *Monte Carlo Particle Transport Methods: Neutron and Photon Calculations*, CRC Press, Boca Raton (1991).
3. C. J. Everett and E. D. Cashwell, "A Third Monte Carlo Sampler," Los Alamos National Laboratory Report, LA-9721-MS, (March 1983).
4. G. Compte de Buffon, "Essai d'arithmetique morale," *Supplement a la Naturelle*, Vol. 4, 1777.
5. A Hall, "On an Experimental Determination of Pi," *Messeng. Math.*, 2, 113-114 (1873).
6. J. M. Hammersley and D. C. Handscomb, *Monte Carlo Methods*, John Wiley & Sons, New York (1964).
7. Marquis Pierre-Simon de Laplace, *Theorie Analytique des Probabilities, Livre 2* pp. 356-366 contained in *Oeuvres Completes de Laplace, de L'Academie des Sciences*, Paris, Vol. 7, part 2, 1786.
8. Lord Kelvin, "Nineteenth Century Clouds Over the Dynamical Theory of Heat and Light," *Philosophical Magazine*, series 6, 2, 1 (1901).
9. W. W. Wood, "Early History of Computer Simulations in Statistical Mechanics and Molecular Dynamics," International School of Physics "Enrico Fermi," Varenna, Italy, 1985, Molecular-Dynamics Simulation of Statistical Mechanical Systems, XCVII Corso (Soc. Italiana di Fisica, Bologna) (1986).
10. Necia Grant Cooper, Ed., *From Cardinals to Chaos — Reflections on the Life and Legacy of Stanislaw Ulam*, Cambridge University Press, New York (1989).
11. "Fermi Invention Rediscovered at LASL," *The Atom*, Los Alamos Scientific Laboratory (October 1966).
12. N. Metropolis and S. Ulam, "The Monte Carlo Method," *J. Amer. Stat. Assoc.*, 44, 335 (1949).
13. Herman Kahn, "Modifications of the Monte Carlo Method," *Proceeding, Seminar on Scientific Computation*, Nov. 1949, IBM, New York, 20-27 (1950).
14. A. S. Householder, G. E. Forsythe, and H. H. Germond, Ed., *Monte Carlo Methods*, NBS Applied Mathematics Series, Vol. 12, 6, (1951).
15. D. H. Lehmer, "Mathematical Methods in Large-Scale Computing Units," *Ann. Comp. Lab.*, Harvard Univ. 26, 141-146 (1951).
16. Herman Kahn, "Applications of Monte Carlo," AECU-3259 Report, Rand Corporation, Santa Monica, CA, (1954).
17. E. D. Cashwell and C. J. Everett, *A Practical Manual on the Monte Carlo Method for Random Walk Problems*, Pergamon Press, Inc., New York (1959).
18. Robert R. Johnston, "A General Monte Carlo Neutronics Code," Los Alamos Scientific Laboratory Report, LAMS-2856 (March 1963).
19. E. D. Cashwell, J. R. Neergaard, W. M. Taylor, and G. D. Turner, "MCN: A Neutron Monte Carlo Code," Los Alamos Scientific Laboratory Report, LA-4751 (January 1972).

## CHAPTER 2 REFERENCES

20. E. D. Cashwell, J. R. Neergaard, C. J. Everett, R. G. Schrandt, W. M. Taylor, and G. D. Turner, "Monte Carlo Photon Codes: MCG and MCP," Los Alamos National Laboratory Report, LA-5157-MS (March 1973).
21. J. A. Halblieb and T. A. Mehlhorn, "ITS: The Integrated TIGER Series of Coupled Electron/Photon Monte Carlo Transport Codes," Sandia National Laboratory Report, SAND 84-0573 (1984).
22. E. D. Cashwell and C. J. Everett, "Intersection of a Ray with a Surface of Third or Fourth Degree," Los Alamos Scientific Laboratory Report, LA-4299 (December 1969).
23. R. Kinsey, "Data Formats and Procedures for the Evaluated Nuclear Data File, ENDF," Brookhaven National Laboratory Report, BNL-NCS-50496 (ENDF 102) 2nd Edition (ENDF/B-V) (October 1979).
24. R. J. Howerton, D. E. Cullen, R. C. Haight, M. H. MacGregor, S. T. Perkins, and E. F. Plechaty, "The LLL Evaluated Nuclear Data Library (ENDL): Evaluation Techniques, Reaction Index, and Descriptions of Individual Reactions," Lawrence Livermore Scientific Laboratory Report UCRL-50400, Vol. 15, Part A (September 1975).
25. E. D. Arthur and P. G. Young, "Evaluated Neutron-Induced Cross Sections for  $^{54,56}\text{Fe}$  to 40 MeV," Los Alamos National Laboratory report LA-8626-MS (ENDF-304) (December 1980).
26. D. G. Foster, Jr. and E. D. Arthur, "Average Neutronic Properties of "Prompt" Fission Products," Los Alamos National Laboratory report LA-9168-MS (February 1982).
27. E. D. Arthur, P. G. Young, A. B. Smith, and C. A. Philis, "New Tungsten Isotope Evaluations for Neutron Energies Between 0.1 and 20 MeV," *Trans. Am. Nucl. Soc.* 39, 793 (1981).
28. M. W. Asprey, R. B. Lazarus, and R. E. Seamon, "EVXS: A Code to Generate Multigroup Cross Sections from the Los Alamos Master Data File," Los Alamos Scientific Laboratory report LA-4855 (June 1974).
29. R. E. MacFarlane, D. W. Muir, and R. M. Boicourt, "The NJOY Nuclear Data Processing System, Volume I: User's Manual," Los Alamos National Laboratory report LA-9303-M, Vol. I (ENDF-324) (May 1982).  
R. E. MacFarlane, D. W. Muir, and R. M. Boicourt, "The NJOY Nuclear Data Processing System, Volume II: The NJOY, RECONR, BROADR, HEATR, and THERMR Modules," Los Alamos National Laboratory report LA-9303-M, Vol. II (ENDF-324) (May 1982).
30. R. J. Howerton, R. E. Dye, P. C. Giles, J. R. Kimlinger, S. T. Perkins and E. F. Plechaty, "Omega Documentation," Lawrence Livermore National Laboratory report UCRL-50400, Vol. 25 (August 1983).
31. E. Storm and H. I. Israel, "Photon Cross Sections from 0.001 to 100 Mev for Elements 1 through 100," Los Alamos Scientific Laboratory report LA-3753 (November 1967).
32. J. H. Hubbell, W. J. Veigele, E. A. Briggs, R. T. Brown, D. T. Cromer and R. J. Howerton, "Atomic Form Factors, Incoherent Scattering Functions, and Photon Scattering Cross Sections," *J. Phys. Chem. Ref. Data* 4, 471 (1975).
33. C. J. Everett and E. D. Cashwell, "MCP Code Fluorescence-Routine Revision," Los Alamos Scientific Laboratory report LA-5240-MS (May 1973).

34. D. E. Cullen, M. H. Chen, J. H. Hubbell, S. T. Perkins, E. F. Plechaty, J. A. Rathkopf, and J. H. Schfield, "Tables and Graphs of Photon-Interaction Cross Sections from 10 eV to 100 GeV Derived from the LLNL Evaluated Photon Data Library (EPDL)," Lawrence Livermore National Laboratory report UCRL-50400, Vol. 6 (October 31, 1989).
35. J. A. Halbleib, R. P. Kensek, T. A. Mehlhorn, G. D. Valdez, S. M. Seltzer, and M. J. Berger, "ITS Version 3.0: Integrated TIGER Series of Coupled Electron/Photon Monte Carlo Transport Codes," SAND91-1634 (1992).
36. M. A. Gardner and R. J. Howerton, "ACTL: Evaluated Neutron Activation Cross-Section Library—Evaluation Techniques and Reaction Index," Lawrence Livermore National Laboratory report UCRL-50400, Vol. 18 (October 1978).
37. J. U. Koppel and D. H. Houston, "Reference Manual for ENDF Thermal Neutron Scattering Data," General Atomics report GA-8744, Revised (ENDF-269) (July 1978).
38. J. C. Wagner, E. L. Redmond II, S. P. Palmtag, and J. S. Hendricks, "MCNP: Multigroup/Adjoint Capabilities," Los Alamos National Laboratory report, LA-12704 (December 1993).
39. J. E. Morel, L. J. Lorence, Jr., R. P. Kensek, J. A. Halbleib, and D. P. Sloan, "A Hybrid Multigroup/Continuous-Energy Monte Carlo Method for Solving the Boltzmann-Fokker-Planck Equation," *Nucl. Sci. Eng.*, **124**, p. 369–389 (1996).
40. L. J. Lorence, Jr., J. E. Morel, G. D. Valdez, "Physics Guide to CEPXS: A Multigroup Coupled Electron-Photon Cross-Section Generating Code, Version 1.0," SAND89-1685 (1989) and "User's Guide to CEPXS/ONED--ANT: A One-Dimensional Coupled Electron-Photon Discrete Ordinates Code Package, Version 1.0," SAND89-1661 (1989) and L. J. Lorence, Jr., W. E. Nelson, J. E. Morel, "Coupled Electron-Photon Transport Calculations Using the Method of Discrete-Ordinates," IEEE/NSREC, Vol. NS-32, No. 6, Dec. 1985.
41. R. C. Little and R. E. Seamon, "Neutron-Induced Photon Production in MCNP," *Proceedings of the Sixth International Conference on Radiation Shielding*, Vol. I, 151, (May 1983).
42. J. S. Hendricks and R. E. Prael, "Monte Carlo Next-Event Estimates from Thermal Collisions," *Nucl. Sci. Eng.*, **109** (3) pp. 150-157 (October 1991).
43. J. S. Hendricks, R. E. Prael, "MCNP  $S(\alpha,\beta)$  Detector Scheme," Los Alamos National Laboratory report, LA-11952 (October 1990).
44. H. Kahn, "Applications of Monte Carlo," AEC-3259 The Rand Corporation (April 1956).
45. L. Koblinger, "Direct Sampling from the Klein-Nishina Distribution for Photon Energies Above 1.4 MeV," *Nucl. Sci. Eng.*, **56**, 218 (1975).
46. R. N. Blomquist and E. M. Gelbard, "An Assessment of Existing Klein-Nishina Monte Carlo Sampling Methods," *Nucl. Sci. Eng.*, **83**, 380 (1983).
47. G. W. Grodstein, "X-Ray Attenuation Coefficients from 10 keV to 100 MeV," National Bureau of Standards, Circular No. 583 (1957).
48. S. Goudsmit and J. L. Saunderson, "Multiple Scattering of Electrons," *Phys. Rev.* **57** (1940) 24.
49. L. Landau, "On the Energy Loss of Fast Particles by Ionization," *J. Phys. USSR* **8** (1944)

## CHAPTER 2 REFERENCES

- 201.
50. O. Blunck and S. Leisegang, "Zum Energieverlust schneller Elektronen in dünnen Schichten," *Z. Physik* **128** (1950) 500.
  51. M. J. Berger, "Monte Carlo Calculation of the Penetration and Diffusion of Fast Charged Particles," in *Methods in Computational Physics, Vol. 1*, edited by B. Alder, S. Fernbach, and M. Rotenberg, (Academic Press, New York, 1963) 135.
  52. Stephen M. Seltzer, "An Overview of ETRAN Monte Carlo Methods," in *Monte Carlo Transport of Electrons and Photons*, edited by Theodore M. Jenkins, Walter R. Nelson, and Alessandro Rindi, (Plenum Press, New York, 1988) 153.
  53. J. Halbleib, "Structure and Operation of the ITS Code System," in *Monte Carlo Transport of Electrons and Photons*, edited by Theodore M. Jenkins, Walter R. Nelson, and Alessandro Rindi, (Plenum Press, New York, 1988) 249.
  54. R. M. Sternheimer, M. J. Berger, and S. M. Seltzer, "Density Effect for the Ionization Loss of Charged Particles in Various Substances," *Phys. Rev.* **B26** (1982) 6067.
  55. R. M. Sternheimer and R. F. Peierls, "General Expression for the Density Effect for the Ionization Loss of Charged Particles," *Phys. Rev.* **B3** (1971) 3681.
  56. T. A. Carlson, *Photoelectron and Auger Spectroscopy*, Plenum Press, New York, N.Y. 1975.
  57. Stephen M. Seltzer, "Cross Sections for Bremsstrahlung Production and Electron Impact Ionization," in *Monte Carlo Transport of Electrons and Photons*, edited by Theodore M. Jenkins, Walter R. Nelson, and Alessandro Rindi, (Plenum Press, New York, 1988) 81.
  58. S. M. Seltzer and M. J. Berger, "Bremsstrahlung Spectra from Electron Interactions with Screened atomic Nuclei and Orbital Electrons", *Nucl. Instr. Meth.* **B12** (1985) 95.
  59. S. M. Seltzer and M. J. Berger, "Bremsstrahlung Energy Spectra from Electrons with Kinetic Energy 1 keV - 10 GeV Incident on Screened Nuclei and Orbital Electrons of Neutral Atoms with Z=1 to 100", *Atom. Data and Nuc. Data Tables* **35**, (1986) 345.
  60. E. Rutherford, "The Scattering of  $\alpha$  and  $\beta$  Particles by Matter and the Structure of the Atom," *Philos. Mag.* **21** (1911) 669.
  61. W. Börsch-Supan, "On the Evaluation of the Function  $\phi(\lambda) = \frac{1}{2\pi i} \int_{\sigma-i\infty}^{\sigma+i\infty} e^{\mu \ln \mu + \lambda \mu} d\mu$  for Real Values of  $\lambda$ ," *J. Res. National Bureau of Standards* **65B** (1961) 245.
  62. J. A. Halbleib, R. P. Kensek, T. A. Mehlhorn, G. D. Valdez, S. M. Seltzer, and M. J. Berger, "ITS Version 3.0: The Integrated TIGER Series of Coupled Electron/Photon Monte Carlo Transport Codes," Sandia National Laboratories report SAND91-1634 (March 1992).
  63. O. Blunck and K. Westphal, "Zum Energieverlust energiereicher Elektronen in dünnen Schichten," *Z. Physik* **130** (1951) 641.
  64. V. A. Chechin and V. C. Ermilova, "The Ionization-Loss Distribution at Very Small Absorber Thickness," *Nucl. Instr. Meth.* **136** (1976) 551.
  65. Stephen M. Seltzer, "Electron-Photon Monte Carlo Calculations: The ETRAN Code," *Appl. Radiat. Isot.* Vol. 42, No. 10 (1991) pp. 917-941.
  66. M. E. Riley, C. J. MacCallum, and F. Biggs, "Theoretical Electron-Atom Elastic

- Scattering Cross Sections. Selected Elements, 1 keV to 256 keV,” *Atom. Data and Nucl. Data Tables* **15** (1975) 443.
67. N. F. Mott, “The Scattering of Fast Electrons by Atomic Nuclei,” *Proc. Roy. Soc. (London)* **A124** (1929) 425.
  68. G. Moliere, “Theorie der Streuung schneller geladener Teilchen II: Mehrfach- und Vielfachstreuung,” *Z. Naturforsch* **3a** (1948) 78.
  69. H. A. Bethe and W. Heitler, “On Stopping of Fast Particles and on the Creation of Positive Electrons,” *Proc. Roy. Soc. (London)* **A146** (1934) 83.
  70. H. W. Koch and J. W. Motz, “Bremsstrahlung Cross-Section Formulas and Related Data,” *Rev. Mod. Phys.* **31** (1959) 920.
  71. Martin J. Berger and Stephen M. Seltzer, “Bremsstrahlung and Photoneutrons from Thick Tungsten and Tantalum Targets,” *Phys. Rev.* **C2** (1970) 621.
  72. R. H. Pratt, H. K. Tseng, C. M. Lee, L. Kissel, C. MacCallum, and M. Riley, “Bremsstrahlung Energy Spectra from Electrons of Kinetic Energy  $1 \text{ keV} \leq T \leq 2000 \text{ keV}$  Incident on Neutral Atoms  $2 < Z < 92$ ,” *Atom. Data and Nuc. Data Tables* **20**, (1977) 175; errata in **26** (1981) 477.
  73. H. K. Tseng and R. H. Pratt, “Exact Screened Calculations of Atomic-Field Bremsstrahlung,” *Phys. Rev.* **A3** (1971) 100.
  74. H. K. Tseng and R. H. Pratt, “Electron Bremsstrahlung from Neutral Atoms,” *Phys. Rev. Lett.* **33** (1974) 516.
  75. H. Davies, H. A. Bethe, and L. C. Maximom, “Theory of Bremsstrahlung and Pair Production. II. Integral Cross Section for Pair Production,” *Phys. Rev.* **93** (1954) 788; and H. Olsen, “Outgoing and Ingoing Waves in Final States and Bremsstrahlung,” *Phys. Rev.* **99** (1955) 1335.
  76. G. Elwert, “Verscharte Berechnung von Intensitat und Polarisation im Kontinuierlichen Rontgenspektrum,” *Ann. Physick* **34** (1939) 178.
  77. R. J. Jabbur and R. H. Pratt, “High-Frequency Region of the Spectrum of Electron and Positron Bremsstrahlung,” *Phys. Rev.* **129** (1963) 184; and “High-Frequency Region of the Spectrum of Electron and Positron Bremsstrahlung II,” *Phys. Rev.* **133** (1964) 1090.
  78. J. H. Hubbell, W. J. Veigele, E. A. Briggs, R. T. Brown, D. T. Cromer, and R. J. Howerton, “Atomic Form Factors, Incoherent Scattering Functions, and Photon Scattering Cross Sections,” *J. Phys. Chem. Ref. Data* **4** (1975) 471; and J. H. Hubbell and I. Overbo, “Relativistic Atomic Form Factors and Photon Coherent Scattering Cross sections,” *J. Phys. Chem. Ref. Data* **8** (1979) 69.
  79. H. K. Tseng and R. H. Pratt, “Electron Bremsstrahlung Energy Spectra Above 2 MeV,” *Phys. Rev.* **A19** (1979) 1525.
  80. E. Haug, “Bremsstrahlung and Pair Production in the field of free Electrons,” *Z. Naturforsch.* **30a** (1975) 1099.
  81. C. Moller, “Zur Theorie des Durchgang schneller Elektronen durch Materie,” *Ann. Physik.* **14** (1932) 568.
  82. D. P. Sloan, “A New Multigroup Monte Carlo Scattering Algorithm Suitable for Neutral and Charged-Particle Boltzmann and Fokker-Planck Calculations,” Ph.D. dissertation,



## CHAPTER 2

### REFERENCES

- Sandia National Laboratories report SAND83-7094, (May 1983).
83. K. J. Adams and M. Hart, "Multigroup Boltzmann-Fokker-Planck Electron Transport Capability in MCNP," *Trans. Am. Nucl. Soc.*, **73**, 334 (1995).
  84. J. E. Stewart, "A General Point-on-a-Ring Detector," *Transactions of the American Nuclear Society*, **28**, 643 (1978).
  85. R. A. Forster, "Ring Detector and Angle Biasing," Los Alamos Scientific Laboratory technical memorandum TD-6-8-79 (July 1979).
  86. S. P. Pederson, R. A. Forster, and T. E. Booth, "Confidence Interval Procedures for Monte Carlo Transport Simulations," *Nucl. Sci. Eng.* **127**, 54-77 (1997).
  87. Guy Estes and Ed Cashwell, "MCNP1B Variance Error Estimator," TD-6-27-78(8/31/78).
  88. A. Dubi, "On the Analysis of the Variance in Monte Carlo Calculations," *Nucl. Sci. Eng.*, **72**, 108 (1979). See also I. Lux, "On Efficient Estimation of Variances," *Nucl. Sci. Eng.*, **92**, 607 (1986).
  89. Shane P. Pederson, "Mean Estimation in Highly Skewed Samples," Los Alamos National Laboratory Report LA-12114-MS (1991).
  90. T. E. Booth, "Analytic Comparison of Monte Carlo Geometry Splitting and Exponential Transform," *Trans. Am. Nucl. Soc.*, **64**, 303 (1991).
  91. T. E. Booth, "A Caution on Reliability Using "Optimal" Variance Reduction Parameters," *Trans. Am. Nucl. Soc.*, **66**, 278 (1991).
  92. T. E. Booth, "Analytic Monte Carlo Score Distributions for Future Statistical Confidence Interval Studies," *Nucl. Sci. Eng.*, **112**, 159 (1992).
  93. R. A. Forster, "A New Method of Assessing the Statistical Convergence of Monte Carlo Solutions," *Trans. Am. Nucl. Soc.*, **64**, 305 (1991).
  94. R. A. Forster, S. P. Pederson, T. E. Booth, "Two Proposed Convergence Criteria for Monte Carlo Solutions," *Trans. Am. Nucl. Soc.*, **64**, 305 (1991).
  95. J. R. M. Hosking and J. R. Wallis, "Parameter and Quantile Estimation for the Generalized Pareto Distribution," *Technometrics*, **29**, 339 (1987).
  96. W. H. Press, B. P. Flannery, S. A. Teukolsky, and W. T. Vetterling, *Numerical Recipes: The Art of Scientific Computing (FORTRAN Version)*, Cambridge University Press (1990).
  97. Malvin H. Kalos, Paula A Whitlock, *Monte Carlo Methods, Volume I: Basics*, John Wiley & Sons, New York, 1987.
  98. T. E. Booth, "A Sample Problem for Variance Reduction in MCNP," Los Alamos National Laboratory report LA-10363-MS (June 1985).
  99. R. A. Forster, R. C. Little, J. F. Briesmeister, and J. S. Hendricks, "MCNP Capabilities For Nuclear Well Logging Calculations," *IEEE Transactions on Nuclear Science*, **37** (3), 1378 (June 1990).
  100. T. E. Booth and J. S. Hendricks, "Importance Estimation in Forward Monte Carlo Calculations," *Nucl. Tech./Fusion*, **5** (1984).
  101. F. H. Clark, "The Exponential Transform as an Importance-Sampling Device, A Review," ORNL-RSIC-14 (January 1966).
  102. P. K. Sarkar and M. A. Prasad, "Prediction of Statistical Error and Optimization of Biased

- Monte Carlo Transport Calculations,” *Nucl. Sci. Eng.*, **70**, 243-261, (1979).
103. J. S. Hendricks, “Construction of Equiprobable Bins for Monte Carlo Calculation,” *Trans. Am. Nucl. Soc.*, **35**, 247 (1980).
  104. G. Bell and S. Glasstone, *Nuclear Reactor Theory*, Litton Educational Publishing, Inc., 1970.
  105. T. J. Urbatsch, R. A. Forster, R. E. Prael, and R. J. Beckman, “Estimation and Interpretation of  $k_{eff}$  Confidence Intervals in MCNP,” Los Alamos National Laboratory report LA-12658, (November 1995).
  106. C. D. Harmon II, R. D. Busch, J. F. Briesmeister, and R. A. Forster, “Criticality Calculations with MCNP, A Primer,” Nuclear Criticality Safety Group, University of New Mexico, Los Alamos National Laboratory, (December 1993).
  107. E. M. Gelbard and R. Prael, “Computations of Standard Deviations in Eigenvalue Calculations,” *Progress in Nuclear Energy*, **24**, p 237 (1990).
  108. G. D. Spriggs, R. D. Busch, K. J. Adams, D. K. Parsons, L. Petrie, and J. S. Hendricks, “On the Definition of Neutron Lifetimes in Multiplying and Nonmultiplying Systems,” Los Alamos National Laboratory Report, LA-13260-MS, (March 1997).
  109. M. Halperin, “Almost Linearly-Optimum Combination of Unbiased Estimates,” *Amer. Stat. Ass. J.*, **56**, 36-43 (1961).
  110. R. C. Gast and N. R. Candelore, “The Recap-12 Monte Carlo Eigenfunction Strategy and Uncertainties,” WAPD-TM-1127 (L) (1974).
  111. S. S. Shapiro and M. B. Wilk, “An Analysis of Variance Test for Normality,” *Biometrika*, **52**, p. 591 (1965).
  112. R. B. D'Agostino, “An Omnibus Test of Normality for Moderate and Large Size Samples,” *Biometrika*, **58**, p. 341 (1971).
  113. L. L. Carter, T. L. Miles, and S. E. Binney, “Quantifying the Reliability of Uncertainty Predictions in Monte Carlo Fast Reactor Physics Calculations,” *Nucl. Sci. Eng.*, **113**, p. 324 (1993). J. S. Hendricks, “Calculation of Cell Volumes and Surface Areas in MCNP,” Los Alamos National Laboratory report LA-8113-MS (January 1980).
  114. J. S. Hendricks, “Calculation of Cell Volumes and Surface Areas in MCNP,” Los Alamos National Laboratory report LA-8113-MS (January 1980).
  115. B. Spain, *Analytical Conics*, Pergamon, 1957.
  116. J. S. Hendricks, “Effects of Changing the Random Number Stride in Monte Carlo Calculations,” *Nucl. Sci. Eng.*, **109** (1) pp. 86-91 (September 1991).
  117. J. E. Olhoeft, “The Doppler Effect for a Non-Uniform Temperature Distribution in Reactor Fuel Elements,” WCAP-2048, Westinghouse Electric Corporation, Atomic Power Division, Pittsburgh (1962).
  118. H. Takahashi, “Monte Carlo Method for Geometrical Perturbation and its Application to the Pulsed Fast Reactor,” *Nucl. Sci. Eng.* **41**, p. 259 (1970).
  119. M. C. Hall, “Monte Carlo Perturbation Theory in Neutron Transport Calculations,” PhD. Thesis, University of London (1980).
  120. M. C. Hall, “Cross-Section Adjustment with Monte Carlo Sensitivities: Application to the Winfrith Iron Benchmark,” *Nucl. Sci. Eng.* **81**, p. 423 (1982).

## CHAPTER 2

### REFERENCES

121. H. Rief, "Generalized Monte Carlo Perturbation Algorithms for Correlated Sampling and a Second-Order Taylor Series Approach," *Ann. Nucl. Energy* **11**, p. 455 (1984).
122. G. McKinney, "A Monte Carlo (MCNP) Sensitivity Code Development and Application," M. S. Thesis, University of Washington, (1984).
123. G. W. McKinney, "Theory Related to the Differential Operator Perturbation Technique," Los Alamos National Laboratory Memo, X-6:GWM-94-124 (1994).
124. G. W. McKinney and J. L. Iverson, "Verification of the Monte Carlo Differential Operator Technique for MCNP," Los Alamos National Laboratory Report LA-13098, (February 1996).

## CHAPTER 3

### DESCRIPTION OF MCNP INPUT

Input to MCNP consists of several files, but the main one supplied by the user is the INP (the default name) file, which contains the input information necessary to describe the problem. Only a small subset of all available input cards will be needed in any particular problem. The input cards are summarized by card type on page 3–146. The word “card” is used throughout this manual to describe a single line of input up to 80 characters.

Maximum dimensions exist for some MCNP input items; they are summarized on page 3–150. The user can increase any of these maximum values by altering the code and recompiling.

All features of MCNP should be used with caution and knowledge. This is especially true of detectors and variance reduction schemes; you are encouraged to read the appropriate sections of Chapter 2 before using them.

The units used throughout MCNP are given in Chapter 1 on page 1–20.

#### ***I. INP FILE***

The INP file can have two forms, initiate-run and continue-run. Either can contain an optional message block that replaces or supplements the MCNP execution line information.

##### ***A. Message Block***

A user has the option to use a message block before the problem identification title card in the INP file. In computer environments where there are no execution line messages, the message block is the only means for giving MCNP an execution message. Less crucially, it is a convenient way to avoid retyping an often-repeated message. The message block starts with the string MESSAGE: and is limited to columns 1–80. Alphabetic characters can be upper, lower, or mixed case. The message block ends with a blank line delimiter before the title card. All cards before the blank line delimiter are continuation cards. A \$ and & in the message block are end-of-line markers. The syntax and components of the message are the same as for the regular execution line message discussed on page 1–32. Any filename substitution, program module execution option or keyword entry on the execution line takes precedence over conflicting information in the message block. INP = *filename* is not a legitimate entry in the message block. The name INP can be changed on the execution line only.

## CHAPTER 3 INP FILE

### B. *Initiate-Run*

This form is used to set up a Monte Carlo problem (describe geometry, materials, tallies, etc.) and run if message block is present. The initiate-run file has the following form:

Message Block	} Optional
Blank Line Delimiter	
Title Card	
Cell Cards	
.	
Blank Line Delimiter	
Surface Cards	
.	
Blank Line Delimiter	
Data Cards	
.	
Blank Line Terminator	Recommended
Anything Else	Optional

The first card in the file after the optional message block is the required problem title card. It is limited to one 80-column line and is used as a title in various places in the MCNP output. It can contain any information the user desires (or can even be blank) and often contains information describing the particular problem. Note that a blank card elsewhere is used as a delimiter or as a terminator. Alphabetic characters can be upper, lower, or mixed case.

With a valid set of data cards MCNP will run with or without the blank line terminator. With the terminator MCNP will stop reading the input file there even if additional lines are in the file. Some users like to keep additional material, such as alternative versions of the problem or textual information, associated with the input file itself. The terminator will prevent such additional lines from being read.

### C. *Continue-Run*

Continue-run is used to continue running histories in a problem that was terminated earlier—for example, to run the job 2 hours and then to run it an additional hour later. It can also be used to reconstruct the output of a previous run. A continue-run must contain C or CN in the MCNP execution line or message block to indicate a continue-run. It will start with the last dump unless C m is used to start with the m<sup>th</sup> dump.

In addition to the C or CN option on the MCNP execution line, two files can be important for this procedure: (1) the restart file (default name RUNTPE), and (2) an optional continue-run input file (default name INP).

The run file, generated by MCNP in the initiate-run sequence, contains the geometry, cross sections, problem parameters, tallies, and all other information necessary to restart the job. In addition the problem results at various stages of the run are recorded in a series of dumps. See the PRDMP card (page 3–127) for a discussion of the selection of dump times. As discussed below, the run may be restarted from any of these dumps.

The CN execution message option differs from the C option only in that the dumps produced during the continue-run are written immediately after the fixed data portion of the RUNTPE file rather than after the dump from which the continue-run started. The new dumps overwrite the old dumps, providing a way for the user to prevent unmanageable growth of RUNTPE files. RUNTPE growth also can be controlled by the NDMP entry on the PRDMP card.

The optional continue-run input file must have the word CONTINUE as the first entry on the first line (title card), or after the optional Message Block and its blank line delimiter. Alphabetic characters can be upper, lower, or mixed case. This file has the following form:

Message Block	}	Optional
Blank Line Delimiter		
CONTINUE		
Data Cards		
.		
.		
Blank Line Terminator		Recommended
Anything else		Optional

The data cards allowed in the continue-run input file are a subset of the data cards available for an initiate-run file. The allowed continue-run data cards are FQ, DD, NPS, CTME, IDUM, RDUM, PRDMP, LOST, DBCN, PRINT, KCODE, MPLOT, ZA, ZB, and ZC.

A very convenient feature is that if none of the above items is to be changed (and if the computing environment allows execution line messages), the continue-run input file is not required; only the run file RUNTPE and the C option on the MCNP execution line are necessary. For example, if you run a job for a minute but you want more particles run, execute with the C or CN message on the execute line, and the job will pick up where it stopped and continue until another time limit or particle cutoff is reached or until you stop it manually. This example assumes that a restart file called RUNTPE from the initial run is in your current directory.

## CHAPTER 3

### INP FILE

The complete continue-run execution line option is C m or CN m, where m specifies which dump to pick up from the RUNTPE and to continue with. If m is not specified, the last dump is taken by default. If the initial run producing the RUNTPE was stopped because of particle cutoff (NPS card, page 3–125), NPS must be increased for a continue-run. The NPS card refers to total histories to be run, including preceding continue-runs and the initial run. CTME in a continue-run is the number of minutes more to run, not cumulative total time. To run more KCODE cycles, only the fourth entry KCT matters. Like NPS, KCT refers to total cycles to be run, including previous ones.

In a continue-run, a negative number entered on the NPS card produces a print output file at the time of the requested dump. No more histories will be run. This can be useful when the printed output has been lost or you want to alter the content of the output with the PRINT or FQ cards.

Be cautious if you use a FILES card in the initial run. See page 3–133.

#### ***D. Card Format***

All input lines are limited to 80 columns. Alphabetic characters can be upper, lower, or mixed case. Most input is entered in horizontal form; however, a vertical input format is allowed for data cards. A comment can be added to any input card. A \$ (dollar sign) terminates data entry and anything that follows the \$ is interpreted as a comment. Blank lines are used as delimiters and terminators. Data entries are separated by one or more blanks.

Comment cards can be used anywhere in the INP file after the problem title card and before the last blank terminator card. These cards must have a C anywhere in columns 1–5 followed by at least one blank. Comment cards are printed only with the input file listing and not anywhere else in the MCNP output file. The FCn input card is available for user comments and is printed as a heading for tally n (as a tally title, for example). The SCn card is available for user comments and is printed as a heading for source probability distribution n.

#### **1. Horizontal Input Format**

Cell, surface, and data cards all must begin within the first five columns. The card name or number and particle designator is followed by data entries separated by one or more blanks. Blanks in the first five columns indicate a continuation of the data from the last named card. An & (ampersand) preceded by at least one blank ending a line indicates data will continue on the following card. Data on the continuation card can be in columns 1–80. Completely blank cards are reserved as delimiters between major sections of the input file. An individual entry must be entirely on one line. There can be only one card of any given type for a given particle designation (see page 3–7). Integers must be entered where integer input is required. Other numerical data can be entered as integer or floating point and will be read properly by MCNP. (In fact noninteger numerical data can be entered in any form acceptable to a FORTRAN E-edit descriptor.)

Four features incorporated in the code facilitate input card preparation:

1. nR means *repeat* the immediately preceding entry on the card n times. For example, 2 4R is the same as 2 2 2 2 2.
2. nI means *insert* n linear interpolates between the entries immediately preceding and following this feature. For example, 1.5 2I 3.0 on a card is the same as 1.5 2.0 2.5 3. In the construct X nI Y, if X and Y are integers, and if Y - X is an exact multiple of n+1, correct integer interpolates will be created. Otherwise only real interpolates will be created, but Y will be stored directly in all cases. In the above example, the 2.0 may not be exact, but in the example 1 4I 6 = 1 2 3 4 5 6, all interpolates are exact.
3. xM is a *multiply* feature and when used on an input card, it is replaced by the value of the previous entry on the card multiplied by the factor x. For example, 1 1 2M 2M 2M 2M 4M 2M 2M is equivalent to 1 1 2 4 8 16 64 128 256.
4. nJ can be used on an input card to *jump* over the entry where used and take the default value. As an example, the following two cards are identical in their effect:

DD	.1	1000
DD	J	1000

J J J is also equivalent to 3J. You can jump to a particular entry on a card without having to explicitly specify prior items on the card. This feature is convenient if you know you want to use a default value but can't remember it. DBCN 7J 5082 is another example.

These features apply to both integer and floating point quantities. If n (an integer) is omitted in the constructs nR, nI, and nJ, then n is assumed to be 1. If x (integer or floating point) is omitted in xM, it is a fatal error. The rules for dealing with adjacent special input items are as follows:

1. nR must be preceded by a number or by an item created by R or M.
2. nI must be preceded by a number or by an item created by R or M, and must be followed by a number.
3. xM must be preceded by a number or by an item created by R or M.
4. nJ may be preceded by anything except I and may begin the card input list.

Examples:

1 3M 2R	=	1 3 3 3
1 3M I 4	=	1 3 3.5 4
1 3M 3M	=	1 3 9
1 2R 2I 2.5	=	1 1 1 1.5 2.0 2.5
1 R 2M	=	1 1 2
1 R R	=	1 1 1
1 2I 4 3M	=	1 2 3 4 12
1 2I 4 2I 10	=	1 2 3 4 6 8 10



## CHAPTER 3 INP FILE

3J 4R	is illegal.
1 4I 3M	is illegal.
1 4I J	is illegal.

### 2. Vertical Input Format

Column input is particularly useful for cell parameters and source distributions. Cell importances or volumes strung out on horizontal input lines are not very readable and often cause errors when users add or delete cells. In column format, all the cell parameters for one cell can be on a single line, labeled with the name of the cell. If a cell is deleted, the user deletes just one line of cell parameters instead of hunting for the data item that belongs to the cell in each of several multiline cell parameter cards. For source distributions, corresponding SI, SP, and SB values are side by side. Source options, other than defaults, are on the next line and must all be entered explicitly. The & continuation symbol is not needed, and if present, is ignored.

In column format, card names are put side by side on one input line and the data values are listed in columns under the card names. A # is put somewhere in columns 1–5 on the line with the card names. The card names must be all cell parameters, all surface parameters, or all something else. If a card name appears on a # card, there must not be a regular horizontal card by that name in the same input file. If there are more entries on data value lines than card names on the # line, the first data entry is a cell or surface number. If any cell names are entered, all must be entered. If cell names are entered, the cells don't have to be in the same order as they are in the cell cards block. If cell names are omitted, the default order is the order of the cells in the cell card block. The same rules apply to surface parameters, but because we presently have only one surface parameter (AREA), column input of surface parameters is less useful.

There can be more than one block of column data in an input file. Typically, there would be one block for cell parameters and one for each source distribution. If a lot of cell parameter options are being used, additional blocks of column data would be needed.

The entries in each column do not need to be precisely under the card name at the top of the column, but you might want the columns to be reasonably neat for readability. The column format is intended for input data that naturally fit into columns of equal length, but less tidy data are not prohibited. If a longer column is to the right of a shorter column, the shorter column must be filled with enough J entries to eliminate any ambiguity about which columns the data items are in.

Special syntax items (R, M, I, and J) are not as appropriate in column format as they are on horizontal lines, but they are not prohibited. They are, of course, interpreted vertically instead of horizontally. Multiple special syntax items, such as 9R, are not allowed if cell or surface names are present.

The form of a column input block is

$$\begin{array}{cccccc}
 \# & S_1 & S_2 & \dots & S_m \\
 K_1 & D_{11} & D_{12} & \dots & D_{1m} \\
 K_2 & D_{21} & D_{22} & \dots & D_{2m} \\
 \vdots & \vdots & \vdots & \dots & \vdots \\
 K_n & D_{n1} & D_{n2} & \dots & D_{nm}
 \end{array}$$

1. The # is somewhere in columns 1–5.
2. Each line can be only 80 columns wide.
3. Each column,  $S_i$  through  $D_{li}$ , where  $l$  may be less than  $n$ , represents a regular input card.
4. The  $S_i$  must be valid MCNP card names. They must be all cell parameters, all surface parameters, or all something else.
5.  $D_{li}$  through  $D_{ni}$  must be valid entries for an  $S_i$  card, except that  $D_{l+1,i}$  through  $D_{ni}$  may be some  $J$ 's possibly followed by some blanks.
6. If  $D_{ji}$  is nonblank,  $D_{j,i-1}$  must also be nonblank. A  $J$  may be used if necessary to make  $D_{j,i-1}$  nonblank.
7. The  $S_i$  must not appear anywhere else in the input file.
8. The  $K_j$  are optional integers. If any are nonblank, all must be nonblank.
9. If the  $S_i$  are cell parameter card names, the  $K_j$ , if present, must be valid cell names. The same is true with surface parameters.
10. If the  $K_j$  are present, the  $D_{ji}$  must not be multiple special syntax items, such as  $9R$ .

### ***E. Particle Designators***

Several of the input cards require a particle designator to distinguish between input data for neutrons, for photons and for electrons. These cards are IMP, EXT, FCL, WWN, WWE, WWP, WWGE, DXT, DXC, F, F5X, F5Y, F5Z, PHYS, ELPT, ESPLT, CUT and PERT. The particle designator consists of the symbol : (colon) and the letter N, P or E immediately after the name of the card. At least one blank must follow the particle designator. For example, to enter neutron importances, use an IMP:N card; enter photon importances on an IMP:P card. To specify the same value for more than one kind of particle, a single card can be used instead of several.

Example: IMP:E,P,N 1 1 0. With a tally card, the particle designator follows the card name including tally number. For example, \*F5:N indicates a neutron point detector energy tally. In the heating tally case, both particle designators may appear. The syntax F6:N,P indicates the combined heating tally for both neutrons and photons.

## CHAPTER 3

### INP FILE

#### *F. Default Values*

Many MCNP input parameters have default values that are summarized on page 3–146. Therefore you do not always have to specify explicitly every input parameter every time if the defaults match your needs. If an input card is left out, the default values for all parameters on the card are used. However, if you want to change a particular default parameter on a card but that parameter is preceded by others, you have to specify the others or use the nJ jump feature to jump over the parameters for which you still want the defaults. CUT:P 3J –.10 is a convenient way to use the defaults for the first three parameters on the photon cutoff card but change the fourth.

#### *G. Input Error Messages*

MCNP makes extensive checks (over 400) of the input file for user errors. A fatal error message is printed, both at the terminal and in the OUTF file, if the user violates a basic constraint of the input specification, and MCNP will terminate before running any particles. The first fatal error is real; subsequent error messages may or may not be real because of the nature of the first fatal message. The FATAL option on the MCNP execution line instructs MCNP to ignore fatal errors and run particles, but the user should be extremely cautious about doing this.

Most MCNP error messages are warnings and are not fatal. The user should not ignore these messages but should understand their significance before making important calculations.

In addition to FATAL and WARNING messages, MCNP issues BAD TROUBLE messages immediately before any impending catastrophe, such as a divide by zero, which would otherwise cause the program to “crash.” MCNP terminates as soon as the BAD TROUBLE message is issued. User input errors in the INP file are the most common reason for issuing a BAD TROUBLE message. These error messages indicate what corrective action is required.

#### *H. Geometry Errors*

There is one important kind of input error that MCNP will not detect while processing data from the INP file. MCNP cannot detect overlapping cells or gaps between cells until a particle track actually gets lost. Even then the precise nature of the error may remain unclear. However, there is much that you can and should do to check your geometry before starting a long computer run.

Use the geometry-plotting feature of MCNP to look at the system from several directions and at various scales. Be sure that what you see is what you intend. Any gaps or overlaps in the geometry will probably show up as dashed lines. The intersection of a surface with the plot plane is drawn as a dashed line if there is not exactly one cell on each side of the surface at each point. Dashed lines can also appear if the plot plane happens to coincide with a plane of the problem, if there are any cookie-cutter cells in the source, or if there are DXTRAN spheres in the problem.

Set up and run a short problem in which your system is flooded with particle tracks from an external source. The necessary changes in the INP file are as follows:

1. Add a VOID card to override some of the other specifications in the problem and make all the cells voids, turn heating tallies into flux tallies, and turn off any FM cards.
2. Add another cell and a large spherical surface to the problem such that the surface surrounds the system and the old outside world cell is split by the new surface into two cells: the space between the system and the new surface, which is the new cell, and the space outside the new surface, which is now the outside world cell. Be sure that the new cell has nonzero importance. Actually, it is best to make all nonzero importances equal. If the system is infinite in one or two dimensions, use one or more planes instead of a sphere.
3. Replace the source specifications by an inward directed surface source to flood the geometry with particles:

SDEF    SUR=m   NRM = -1

where m is the number of the new spherical surface added in Step 2. If the new surface is a plane, you must specify the portion to be used by means of POS and RAD or possibly X, Y, and Z source distributions.

Because there are no collisions, a short run will generate a great many tracks through your system. If there are any geometry errors, they should cause some of the particles to get lost.

When a particle first gets lost, whether in a special run with the VOID card or in a regular production run, the history is rerun to produce some special output on the OUTP file. Event-log printing is turned on during the rerun. The event log will show all surface crossings and will tell you the path the particle took to the bad spot in the geometry. When the particle again gets lost, a description of the situation at that point is printed. You can usually deduce the cause of the lost particle from this output. It is not possible to rerun lost particles in a multitasking run.

If the cause of the lost particle is still obscure, try plotting the geometry with the origin of the plot at the point where the particle got lost and with the horizontal axis of the plot plane along the direction the particle was moving. The cause of the trouble is likely to appear as a dashed line somewhere in the plot or as some discrepancy between the plot and your idea of what it should look like.

## CHAPTER 3 CELL CARDS

### II. CELL CARDS

Form:    j            m d    geom    params  
or:       j            LIKE n BUT    list  
          j            = cell number;  $1 \leq j \leq 99999$ .  
                      If cell has transformation,  $1 \leq j \leq 999$ . See page 3–27.  
          m            = 0 if the cell is a void.  
                      = material number if the cell is not a void. This indicates that the cell is to  
                      contain material  $m$ , which is specified on the  $Mm$  card. See page 3–108.  
          d            = absent if the cell is a void.  
                      = cell material density. A positive entry is interpreted as the atomic density  
                      in units of  $10^{24}$  atoms/cm<sup>3</sup>. A negative entry is interpreted as the mass  
                      density in units of g/cm<sup>3</sup>.  
          geom        = specification of the geometry of the cell. It consists of signed surface  
                      numbers and Boolean operators that specify how the regions bounded by  
                      the surfaces are to be combined.  
          params     = optional specification of cell parameters by entries in the  
                      keyword = value form.  
          n            = name of another cell  
          list        = set of keyword = value specifications that define the attributes that differ  
                      between cell  $n$  and  $j$ .

In the geometry specification, a signed surface number stands for the region on the side of the surface where points have the indicated sense. The plus sign for positive sense is optional. The regions are combined by Boolean operators: intersection (no symbol—implicit, like multiplication in algebra); union,  $::$ ; and complement,  $\#$ . Parentheses can be used to control the order of the operations. Parentheses and operator symbols also function as delimiters. Where they are present, blank delimiters are not necessary. The default order of operations is complement first, intersection second, and union last. A number immediately after a complement operator, without parentheses, is interpreted as a cell number and is shorthand for the geometry specification of that cell number.

```
Example:  3  0  -1  2  -4  $ definition of cell 3
          #3                $ equivalent to next line
          #(-1 2 -4)
```

For a simple cell (no union or complement operators), the geometry specification is just a blank-delimited list of the bounding surfaces and ambiguity surfaces of the cell with signs determined by the sense of the cell with respect to each surface. See the Geometry sections of Chapters 1, 2, and 4 for complete explanations of how to specify the geometry of cells in MCNP.

Cell parameters can be defined on cell cards instead of in the data card section of the INP file. A blank is equivalent to the equal sign. If a cell parameter is entered on any cell card, a cell-parameter

card with that name can not be present, nor can the mnemonic appear on any column-format input card. Some cell parameters can be specified on cell cards and a different subset on cell-parameter or column-format cards. The form is keyword=value, where the allowed keywords are IMP, VOL, PWT, EXT, FCL, WWN, DXC, NONU, PD, and TMP, with particle designators where necessary. Four cell parameter cards associated with the repeated structures capability are U, TRCL, LAT and FILL. Like any cell parameter card, these four cards can be placed in the data card section of the INP file. Our recommendation is that the mnemonic and entry for each cell be placed on the cell card line after the cell description. The entries on the TRCL card and the FILL card, in particular, can be quite long and involved and it seems to be conceptually simpler when they are placed on the cell card line.

The LIKE n BUT feature uses keywords for the cell material number and density. The mnemonics are MAT and RHO, respectively. These keywords only can be used following the LIKE n BUT construct. In a normal cell description, material number and density are still the second and third entries on the cell card.

TMP and WWN data can be entered on cell cards in two ways. The keyword=value form TMP1=value TMP2=value etc. can be used or a special syntax is available where the single keyword TMP is followed by all the temperatures of the cell in an order corresponding to the times on the THTME card. The form for the WWN card is analogous: WWN1:n=value or WWN:n followed by all the lower weight bounds for the energy intervals of the cell.

Example: 10 16 -4.2 1 -2 3 IMP:N=4 IMP:P=8 EXT:N=-.4X

This says that cell 10 is to be filled with material 16 at a density of  $4.2 \text{ g/cm}^3$ . The cell consists of the intersections of the regions on the positive side of surface 1, the negative side of surface 2, and the positive side of surface 3. The neutron importance in cell 10 is 4 and the photon importance is 8. Neutrons in cell 10 are subject to an exponential transform in the minus X direction with stretching parameter 0.4.

Here are some precautions when you are preparing cell cards:

1. Avoid excessively complicated cells. MCNP runs faster when the problem geometry is made up of many simpler cells rather than fewer more complicated cells.
2. Avoid adding unneeded surfaces to the geometry description of a cell through poor use of the complement operator. The extra surfaces make the problem run slower and may destroy the necessary conditions for volume and area calculations. See page 4–15.
3. Always use the geometry-plotting feature of MCNP to check the geometry of a problem. See Appendix B.
4. Flood the system with particles from an outside source to find errors in the geometry. See page 3–8.

## CHAPTER 3 SURFACE CARDS

5. If you add or remove cells, change all your cell parameter cards accordingly. The difficulty of this can be reduced if you use vertical format for your cell parameter cards. See page 3–6. Alternatively, define the values of cell parameters on cell cards and eliminate cell parameter cards entirely.

### A. *Shorthand Cell Specification*

The LIKE n BUT feature is very useful in problems with a lot of repeated structures. Cell  $j$  inherits from cell  $n$  the values of all attributes that are not specified in the list. The cell card for cell  $n$  must be before the cell card for cell  $j$  in the INP file. Any card name that appears after the BUT is a cell parameter on a cell card and, therefore, must appear on cell cards only, not on any cards in the data block of the INP file.

```
Example:  2  3  -3.7  -1  IMP:N=2  IMP:P=4
          3  LIKE 2 BUT  TRCL=1  IMP:N=10
```

This says that cell 3 is the same as cell 2 in every respect except that cell 3 has a different location (TRCL=1) and a different neutron importance. The material in cell 3, the density and the definition are the same as cell 2 and the photon importance is the same.

## III. SURFACE CARDS

### A. *Surfaces Defined by Equations*

Form:  $j \quad n \quad a \quad \text{list}$   
 $j$  = surface number:  $1 \leq j \leq 99999$ , with asterisk for a reflecting surface or plus for a white boundary.  
If surface defines a cell that is transformed with TRCL,  $1 \leq j \leq 999$ .  
See page 3–27.  
 $n$  = absent or 0 for no coordinate transformation.  
=  $> 0$ , specifies number of a TR $n$  card.  
=  $< 0$ , specifies surface  $j$  is periodic with surface  $n$ .  
 $a$  = equation mnemonic from Table 3.1  
list = one to ten entries, as required.

The surface types, equations, mnemonics, and the order of the card entries are given in Table 3.1. To specify a surface by this method, find the surface in Table 3.1 and determine the coefficients for the equation (you may need to consult a book on analytical geometry). The information is entered on a surface card according to the above form. Under certain conditions a surface can be defined by specifying geometrical points, as discussed in sections B and C. Surfaces also can be produced by combinatorial–geometry–like macrobodies, described in section D.

A point  $(x,y,z)$  is defined as having positive sense with respect to a surface when the expression for that surface evaluated at  $(x,y,z)$  is positive. The expression for a surface is the left side of the equation for the surface in Table 3.1. With the sphere, cylinder, cone, and torus, this definition is identical to defining the sense to be positive outside the figure. With planes normal to axes (PX, PY, or PZ), the definition gives positive sense for points with  $x$ ,  $y$ , or  $z$  values exceeding the intercept of the plane. For the P, SQ and GQ surfaces, the user supplies all of the coefficients for the expression and thus can determine the sense of the surface at will. This is different from the other cases where the sense, though arbitrary, is uniquely determined by the form of the expression. Therefore, in a surface transformation (see the TRn card on page 3–30) a PX, PY, or PZ surface will sometimes be replaced by a P surface just to prevent the sense of the surface from getting reversed.

If the surface number is preceded by an asterisk, a reflecting surface is defined. A particle track that hits a reflecting surface is reflected specularly. If the surface number is preceded by a plus, a white boundary is defined. Detectors and DXTRAN (next–event estimators) usually should not be used in problems that have reflecting surfaces or white boundaries. See page 2–92. Tallies in problems with reflecting surfaces will need to be normalized differently. See page 2–14.

A negative second entry  $n$  specifies that surface  $j$  is periodic with surface  $k$ . The following restrictions apply:

1. Surfaces  $j$  and  $k$  must be planes.
2. No surface transformation is allowed for the periodic planes.
3. The periodic cell(s) can be infinite or bounded by planes on the top and bottom that can be reflecting or white, but cannot be periodic.
4. Periodic planes can only bound other periodic planes or top and bottom planes.
5. A single zero–importance cell must be on one side of each periodic plane.
6. All periodic planes must have a common rotational vector normal to the geometry top and bottom.
7. Next–event estimators such as detectors and DXTRAN should not be used.



**CHAPTER 3**  
**SURFACE CARDS**

**TABLE 3.1: MCNP Surface Cards**

Mnemonic	Type	Description	Equation	Card Entries
P	Plane	General	$Ax + By + Cz - D = 0$	ABCD
PX		Normal to X-axis	$x - D = 0$	D
PY		Normal to Y-axis	$y - D = 0$	D
PZ		Normal to Z-axis	$z - D = 0$	D
SO	Sphere	Centered at Origin	$x^2 + y^2 + z^2 - R^2 = 0$	R
S		General		$\bar{x} \bar{y} \bar{z} R$
SX		Centered on X-axis	$(x - \bar{x})^2 + (y - \bar{y})^2 + (z - \bar{z})^2 - R^2 = 0$	$\bar{x} R$
SY		Centered on Y-axis	$(x - \bar{x})^2 + y^2 + z^2 - R^2 = 0$	$\bar{y} R$
SZ		Centered on Z-axis	$x^2 + (y - \bar{y})^2 + z^2 - R^2 = 0$ $y^2 + y^2 + (z - \bar{z})^2 - R^2 = 0$	$\bar{z} R$
C/X	Cylinder	Parallel to X-axis	$(y - \bar{y})^2 + (z - \bar{z})^2 - R^2 = 0$	$\bar{y} \bar{z} R$
C/Y		Parallel to Y-axis	$(x - \bar{x})^2 + (z - \bar{z})^2 - R^2 = 0$	$\bar{x} \bar{z} R$
C/Z		Parallel to Z-axis	$(x - \bar{x})^2 + (y - \bar{y})^2 - R^2 = 0$	$\bar{x} \bar{y} R$
CX		On X-axis	$y^2 + z^2 - R^2 = 0$	R
CY		On Y-axis	$x^2 + z^2 - R^2 = 0$	R
CZ		On Z-axis	$x^2 + y^2 - R^2 = 0$	R
K/X	Cone	Parallel to X-axis	$\sqrt{(y - \bar{y})^2 + (z - \bar{z})^2} - t(x - \bar{x}) = 0$	$\bar{x} \bar{y} \bar{z} t^2 \pm 1$
K/Y		Parallel to Y-axis	$\sqrt{(x - \bar{x})^2 + (z - \bar{z})^2} - t(y - \bar{y}) = 0$	$\bar{x} \bar{y} \bar{z} t^2 \pm 1$
K/Z		Parallel to Z-axis	$\sqrt{(x - \bar{x})^2 + (y - \bar{y})^2} - t(z - \bar{z}) = 0$	$\bar{x} \bar{y} \bar{z} t^2 \pm 1$
KX		On X-axis	$\sqrt{y^2 + z^2} - t(x - \bar{x}) = 0$	$\bar{x} t^2 \pm 1$
KY		On Y-axis	$\sqrt{x^2 + z^2} - t(y - \bar{y}) = 0$	$\bar{y} t^2 \pm 1$
KZ		On Z-axis	$\sqrt{x^2 + y^2} - t(z - \bar{z}) = 0$	$\bar{z} t^2 \pm 1$
				$\pm 1$ used only for 1 sheet cone
SQ	Ellipsoid Hyperboloid Paraboloid	Axis not parallel to X-, Y-, or Z-axis	$A(x - \bar{x})^2 + B(y - \bar{y})^2 + C(z - \bar{z})^2 + 2D(x - \bar{x}) + 2E(y - \bar{y}) + 2F(z - \bar{z}) + G = 0$	ABCDE FG $\bar{x} \bar{y} \bar{z}$
GQ	Cylinder Cone Ellipsoid Hyperboloid Paraboloid	Axes not parallel to X-, Y-, or Z-axis	$Ax^2 + By^2 + Cz^2 + Dxy + Eyz + Fzx + Gz + Hy + Jz + K = 0$	ABCDE FGHJK
TX	Elliptical or circular torus. Axis is Parallel to X-, Y-, or Z- axis		$(x - \bar{x})^2/B^2 + (\sqrt{(y - \bar{y})^2 + (z - \bar{z})^2} - A)^2/C^2 - 1 = 0$	$\bar{x} \bar{y} \bar{z} ABC$
TY			$(y - \bar{y})^2/B^2 + (\sqrt{(x - \bar{x})^2 + (z - \bar{z})^2} - A)^2/C^2 - 1 = 0$	$\bar{x} \bar{y} \bar{z} ABC$
TZ			$(z - \bar{z})^2/B^2 + (\sqrt{(x - \bar{x})^2 + (y - \bar{y})^2} - A)^2/C^2 - 1 = 0$	$\bar{x} \bar{y} \bar{z} ABC$
XYZP	Surfaces defined by points			See pages 3-16 and 3-18

Example 1:     j    PY    3

This describes a plane normal to the  $y$ -axis at  $y = 3$  with positive sense for all points with  $y > 3$ .

Example 2:     j    K/Y    0  0  2  .25  1

This specifies a cone whose vertex is at  $(x,y,z) = (0,0,2)$  and whose axis is parallel to the  $y$ -axis. The tangent  $t$  of the opening angle of the cone is 0.5 (note that  $t^2$  is entered) and only the positive (right hand) sheet of the cone is used. Points outside the cone have a positive sense.

Example 3:     j    GQ    1    .25   .75   0    -.866  
                                  0   -12   -2   3.464  39

This is a cylinder of radius 1 cm whose axis is in a plane normal to the  $x$ -axis at  $x = 6$ , displaced 2 cm from the  $x$ -axis and rotated  $30^\circ$  about the  $x$ -axis off the  $y$ -axis toward the  $z$ -axis. The sense is positive for points outside the cylinder. Such a cylinder would be much easier to specify by first defining it in an auxiliary coordinate system where it is symmetric about a coordinate axis and then using the TRn input card (see page 3-30) to define the relation between the basic and auxiliary coordinate systems. The input would then be

j   7   CX   1  
\*TR7   6   1  -1.732  0  30  60

See Chapter 4 for additional examples of the TRn card.

The TX, TY, and TZ input cards represent elliptical tori (fourth degree surfaces) rotationally symmetric about axes parallel to the  $x$ ,  $y$ , and  $z$  axes, respectively. A TY torus is illustrated in Figure 3.1a. Note that the input parameters  $\bar{x}$   $\bar{y}$   $\bar{z}$   $a$   $b$   $c$  specify the ellipse

$$\frac{s^2}{b^2} + \frac{(r-a)^2}{c^2} = 1$$

rotated about the  $s$ -axis in the  $(r,s)$  cylindrical coordinate system (Figure 3.1b) whose origin is at  $\bar{x}$   $\bar{y}$   $\bar{z}$  in the  $x$ ,  $y$ ,  $z$  system. In the case of a TY torus,

$$s = (y - \bar{y})$$

and      $r = \sqrt{(x - \bar{x})^2 + (z - \bar{z})^2}$

A torus is degenerate if  $|a| < c$  where  $0 < a < c$  produces the outer surface (Figure 3.1c), and  $-c < a < 0$  produces the inner surface (Figure 3.1d).

**CHAPTER 3  
SURFACE CARDS**

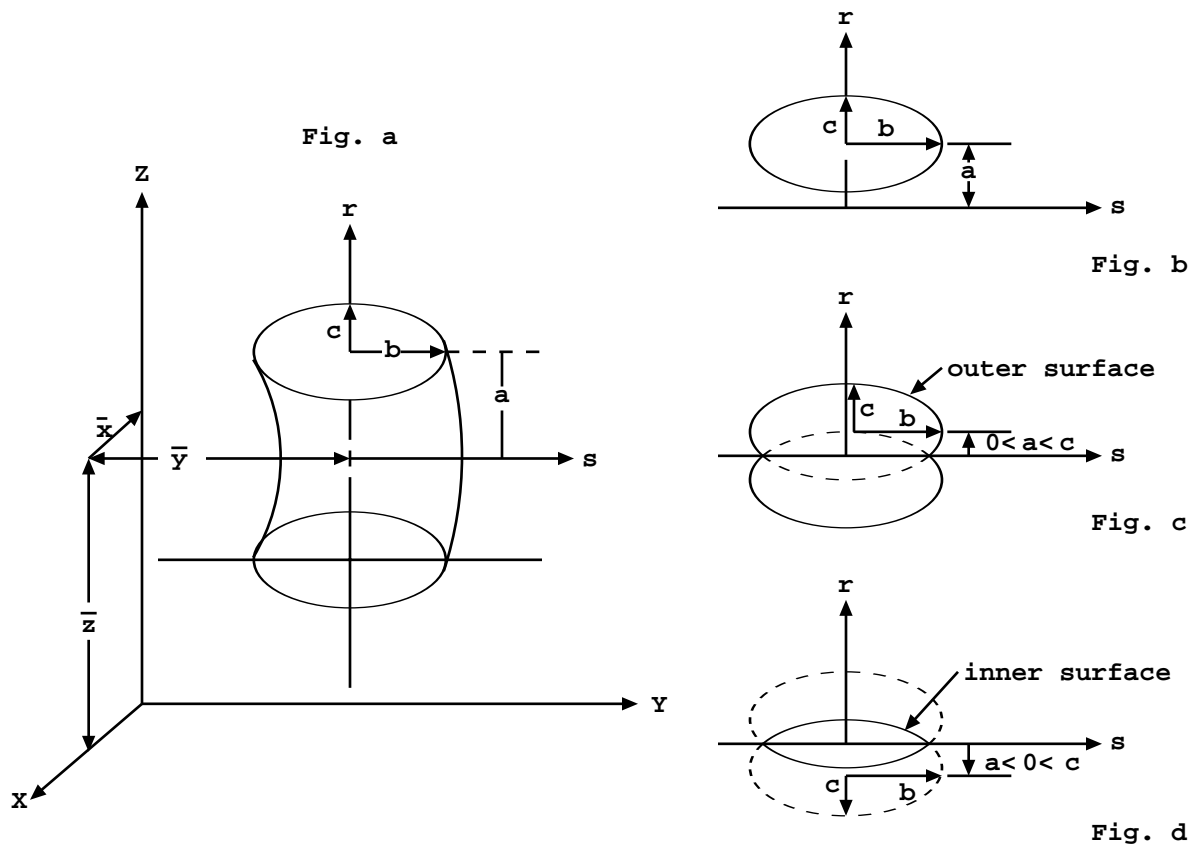

**Figure 3-1. Torus**

Coordinate transformations for tori are limited to those in which each axis of the auxiliary coordinate system is parallel to an axis of the main system.

**B. Axisymmetric Surfaces Defined by Points**

- Form:     j    n    a    list
- j    = surface number:  $1 \leq j \leq 99999$ . If surface defines a cell that is transformed with TRCL,  $1 \leq j \leq 999$ . See page 3-27.
  - n    = absent for no coordinate transformation, or number of TRn card.
  - a    = the letter X, Y, or Z
  - list = one to three coordinate pairs.

Surface cards of type X, Y, and Z can be used to describe surfaces by coordinate points rather than by equation coefficients as in the previous section. The surfaces described by these cards must be

symmetric about the  $x$ -,  $y$ -, or  $z$ -axis, respectively, and, if the surface consists of more than one sheet, the specified coordinate points must all be on the same sheet.

Each of the coordinate pairs defines a geometrical point on the surface. On the Y card, for example, the entries may be

$$j \quad Y \quad y_1 \quad r_1 \quad y_2 \quad r_2$$

where  $r_i = \sqrt{(x_i^2 + z_i^2)}$  and  $y_i$  is the coordinate of point  $i$ .

If one coordinate pair is used, a plane (PX, PY, or PZ) is defined.

If two coordinate pairs are used, a linear surface (PX, PY, PZ, CX, CY, CZ, KX, KY, or KZ) is defined.

If three coordinate pairs are used, a quadratic surface (PX, PY, PZ, SO, SX, SY, SZ, CX, CY, CZ, KX, KY, KZ, or SQ) is defined.

When a cone is specified by two points, a cone of only one sheet is generated.

The senses of these surfaces (except SQ) are determined by the code to be identical to the senses one would obtain by specifying the surface by equations. For SQ, the sense is defined so that points sufficiently far from the axis of symmetry have positive sense. Note that this is different from the equation-defined SQ, where the user could choose the sense freely.

Example 1:  $j \quad X \quad 7.5 \quad 3.2 \quad 4.3$

This describes a surface symmetric about the  $x$ -axis, which passes through the three  $(x,r)$  points (7,5), (3,2), and (4,3). This surface is a hyperboloid of two sheets, converted in MCNP to its equivalent

$$j \quad SQ \quad -.083333333 \quad 1 \quad 1 \quad 0 \quad 0 \quad 0 \quad 68.52083 \quad -26.5 \quad 0 \quad 0.$$

Example 2:  $j \quad Y \quad 1 \quad 2 \quad 1 \quad 3 \quad 3 \quad 4$

This describes two parallel planes at  $Y = 1$  and  $Y = 3$  and is a fatal error because the requirement that all points be on the same sheet is not met.

Example 3:  $j \quad Y \quad 3 \quad 0 \quad 4 \quad 1 \quad 5 \quad 0$

This describes a sphere of radius 1 with center at  $(x,y,z) = (0,4,0)$ .

**CHAPTER 3**  
**SURFACE CARDS**

Example 4: j Z 1 0 2 1 3 4

This surface is rejected because the points are on two different sheets of the hyperboloid

$$x^2 + y^2 - 7z^2 + 20z - 13 = 0$$

However, the surface

j Z 2 1 3 4 5 9.380832

which has the same surface equation as above is accepted because all coordinates lie on a single surface, the right sheet of the hyperboloid.

Example 5: 1 0 1 -2 3 \$ cell 1

```

1 Y -3 2 2 1
2 Y 2 3 3 3 4 2
3 Y 2 1 3 1 4 2

```

This final example defines a cell bounded by a cone, hyperboloid, and an ellipsoid. The three surfaces define the donut-like cell that is symmetric about the y-axis. A cross section of this cell is seen in Figure 3.2. To plot this view, type PX = 0 EX = 5. One surface goes through the points (-3,2) and (2,1). The second surface goes through (2,3), (3,3), and (4,2). The last surface is defined by the points (2,1), (3,1), and (4,2). These coordinate points are in the form (y,r). Using these cards, MCNP indicates that surface 1 is a cone of one sheet, surface 2 is an ellipsoid, and surface 3 is a hyperboloid of one sheet. The equation coefficients for the standard surface equations are printed out for the various surfaces when the PRINT input card or execution option is used. For example, an SQ card defining surface 3 is

3 SQ 1 -1.5 1 0 0 0 -.625 0 2.5 0

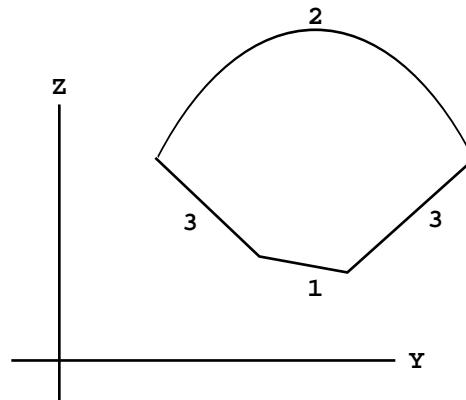

**Figure 3-2.**

**C. General Plane Defined by Three Points**

Form:        j    n   P    $X_1 Y_1 Z_1$                      $X_2 Y_2 Z_2$          $X_3 Y_3 Z_3$   
               j    = surface number:  $1 \leq j \leq 99999$  or  $\leq 999$  if repeated structure.  
               n    = absent or 0 for no coordinate transformation.  
                   =  $> 0$ , specifies number of a TRn card.  
                   =  $< 0$ , specifies surface  $j$  is periodic with surface  $n$ .  
                $(X_i, Y_i, Z_i)$  = coordinates of points to define the plane.

If there are four entries on a P card, they are assumed to be the general plane equation coefficients as in Table 3.1. If there are more than four entries, they give the coordinates of three points lying in the desired plane. The code converts them to the required surface coefficients to produce the plane

$$Ax + By + Cz - D = 0$$

The sense of the plane is determined by requiring the origin to have negative sense. If the plane passes through the origin ( $D = 0$ ), the point  $(0, 0, \infty)$  has positive sense. If this fails ( $D = C = 0$ ), the point  $(0, \infty, 0)$  has positive sense. If this fails ( $D = C = B = 0$ ), the point  $(\infty, 0, 0)$  has positive sense. If this fails, the three points lie in a line and a fatal error is issued.

**D. Surfaces Defined by Macrobodies**

Using a combinatorial–geometry–like macrobody capability is an alternative method of defining cells and surfaces. The combinatorial geometry bodies available are similar to those in the Integrated Tiger Series (ACCEPT) codes. The macrobodies can be mixed with the standard cells and surfaces. The macrobody surface is decomposed internally into surface equations and the facets are assigned individual numbers according to a predetermined sequence. The assigned numbers are the number selected by the user followed by a decimal point and 1, 2, .... The facets can be used for tallying, tally segmentation, other cell definitions, SDEF sources, etc. They cannot be used on the SSR/SSW cards, the surface flagging card, PTRAC, or MCTAL files.

The space inside a body has a negative sense with respect to the macrobody surface and all its facets. The space outside a body has a positive sense. The sense of a facet is the sense assigned to it by the macrobody “master” cell and the facet retains that assigned sense if it appears in other cell descriptions and must be properly annotated. See an example at the end of this section for an illustration.

The following geometry bodies are available and their complete descriptions follow.

BOX	Arbitrarily oriented orthogonal box
RPP	Rectangular Parallelepiped

**CHAPTER 3**  
**SURFACE CARDS**

SPH Sphere  
 RCC Right Circular Cylinder  
 RHP or HEX Right Hexagonal Prism

BOX: Arbitrarily oriented orthogonal box (all corners are 90°.)

BOX  $V_x V_y V_z A_{1x} A_{1y} A_{1z} A_{2x} A_{2y} A_{2z} A_{3x} A_{3y} A_{3z}$   
 where  $V_x V_y V_z = x,y,z$  coordinates of corner  
 $A_{1x} A_{1y} A_{1z} =$  vector of 1st side  
 $A_{2x} A_{2y} A_{2z} =$  vector of 2nd side  
 $A_{3x} A_{3y} A_{3z} =$  vector of 3rd side

Example: BOX  $-1 -1 -1 2 0 0 0 2 0 0 0 2$   
 a cube centered at the origin, 2 cm on a side, sides parallel to the major axes.

RPP: Rectangular Parallelepiped, surfaces normal to major axes, x,y,z values relative to origin.

RPP  $X_{min} X_{max} Y_{min} Y_{max} Z_{min} Z_{max}$

Example: RPP  $-1 1 -1 1 -1 1$   
 equivalent to BOX above.

SPH: Sphere. Equivalent to surface equation for general sphere.

SPH  $V_x V_y V_z R$   
 where  $V_x V_y V_z = x,y,z$  coordinates of center  
 $R =$  radius

RCC: Right Circular Cylinder, can

RCC  $V_x V_y V_z H_x H_y H_z R$   
 where  $V_x V_y V_z =$  center of base  
 $H_x H_y H_z =$  cylinder axis vector  
 $R =$  radius

Example: RCC  $0 -5 0 0 10 0 4$   
 a 10-cm high can about the y-axis, base plane at  $y=-5$  with radius of 4 cm.

RHP or HEX: Right Hexagonal Prism. Differs from ITS (ACCEPT) format.

RHP  $v_1 v_2 v_3 h_1 h_2 h_3 r_1 r_2 r_3 s_1 s_2 s_3 t_1 t_2 t_3$   
 where  $v_1 v_2 v_3 = x,y,z$  coordinates of the bottom of the hex  
 $h_1 h_2 h_3 =$  vector from the bottom to the top  
 for a z-hex with height h,  $h_1, h_2, h_3 = 0 0 h$   
 $r_1 r_2 r_3 =$  vector from the axis to the middle of the first facet  
 for a pitch  $2p$  facet normal to y-axis,  $r_1, r_2, r_3 = 0 p 0$   
 $s_1 s_2 s_3 =$  vector to center of the 2nd facet

$t1 \ t2 \ t3 =$  vector to center of the 3rd facet

Example: RHP 0 0 -4 0 0 8 0 2 0  
a hexagonal prism about the z-axis whose base plane is at  $z=-4$  with a height of 8-cm and whose first facet is normal to the y-axis at  $y=2$ .

The facets of the bodies are sequentially numbered and can be used on other MCNP cards. BOX and RPP can be infinite in a dimension, in which case those two facets are skipped and the numbers of the remaining facets are decreased by two. RHP can be infinite in the axial dimension in which case facets 7 and 8 do not exist. The order of the facet numbering follows for each geometry body. Facet numbering can be displayed graphically with MBODY=OFF in the geometry plotter.

BOX:           1 plane normal to end of A1x A1y A1z  
                  2 plane normal to beginning of A1x A1y A1z  
                  3 plane normal to end of A2x A2y A2z  
                  4 plane normal to beginning of A2x A2y A2z  
                  5 plane normal to end of A3x A3y A3z  
                  6 plane normal to beginning of A3x A3y A3z

RPP:           1 Plane Xmax  
                  2 Plane Xmin  
                  3 Plane Ymax  
                  4 Plane Ymin  
                  5 Plane Zmax  
                  6 Plane Zmin

SPH:           treated as a regular surface so no facet

RCC:           1 Cylindrical surface of radius R  
                  2 Plane normal to end of Hx Hy Hz  
                  3 Plane normal to beginning of Hx Hy Hz

RHP or HEX 1 Plane normal to end of r1 r2 r3  
                  2 Plane opposite facet 1  
                  3 Plane normal to end of s1 s2 s3  
                  4 Plane opposite facet 3  
                  5 Plane normal to end of t1 t2 t3  
                  6 Plane opposite facet 5  
                  7 Plane normal to end of h1 h2 h3  
                  8 Plane normal to beginning of h1 h2 h3



### CHAPTER 3 DATA CARDS

The following input file describes five cells and illustrates a combination of the various body and cell/surface descriptions. Surface numbers are in italics alongside the planes they define. Note that the cell and surface numbers do not have to start with 1 or be consecutive.

```

3 0 -1.2 -1.1 1.4 -1.5 -1.6 99
4 0 1.1 -2001.1 -5.3 -5.5 -5.6 -5.4
5 0 -5
1 0 -1
2 like 1 but trcl = (2 0 0)
9 0 (-5.1 : 1.3 : 2001.1 : -99 : 5.5 : 5.6) #5

```

```

5 rpp -2 0 -2 0 -1 1
1 rpp 0 2 0 2 -1 1
99 py -2

```

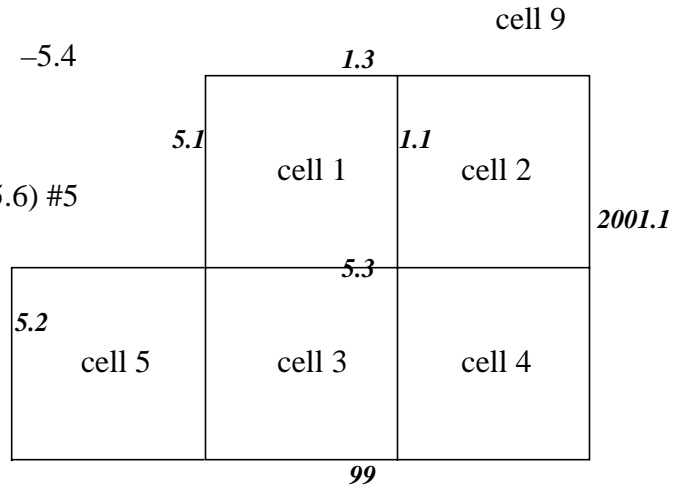

alternative descriptions of cell 3:

```

3 0 5.1 -1.1 -5.3 -5.5 -5.6 99
3 0 5.1 -1.1 1.4 -5.5 -5.6 -5.4
3 0 -1.2 -1.1 -5.3 -5.5 -5.6 -5.4

```

### IV. DATA CARDS

All MCNP input cards other than those for cells and surfaces are entered after the blank card delimiter following the surface card block. The mnemonic must begin within the first five columns. These cards fall into the following categories:

<u>Category</u>	<u>Page</u>
(A) Problem type	3-23
(B) Geometry cards	3-23
(C) Variance reduction	3-32
(D) Source specification	3-49
(E) Tally specification	3-73
(F) Material and cross section specification	3-107
(G) Energy and thermal treatment	3-116
(H) Problem cutoffs	3-123
(I) User data arrays	3-126
(J) Peripheral cards	3-127

These card categories are described below. Only the cards listed on page 3-3 are allowed in a continue-run input file. No data card can be used more than once with the same number or particle type designations. For example, M1 and M2 are acceptable, as are CUT:N and CUT:P, but two M1 cards or two CUT:N cards are disallowed.

**A. Problem Type (MODE) Card**

Form:    MODE      $x_1 \dots x_i$   
 $x_i$     = N for neutron transport  
           P for photon transport  
           E for electron transport

Default: If the MODE card is omitted, MODE N is assumed.

Use: A MODE card is required unless MODE=N. The entries are space delineated.

**B. Geometry Cards**

<u>Mnemonic</u>	<u>Card Type</u>	<u>Page</u>
VOL	Cell volumes	3-23
AREA	Surface areas	3-24
U	Universes	3-26
TRCL	Cell transformations	3-27
LAT	Lattices	3-28
FILL	Fill card	3-29
TR	Coordinate transformation	3-30

**1. VOL Cell Volume Card**

Form:    VOL      $x_1 x_2 \dots x_i$   
       or:   VOL     NO    $x_1 x_2 \dots x_i$   
 $x_i$     = volume of cell  $i$  where  $i=1, 2, \dots$  number of cells in the problem.  
 NO    = no volumes or areas are calculated.

Default:    MCNP attempts to calculate the volume of all cells unless “NO” appears on the VOL card. If no value is entered for a cell on the VOL card, the calculated volume is used.

Use:        Optional card used to input cell volumes.

## CHAPTER 3 DATA CARDS

With the VOL card, if the number of entries does not equal the number of cells in the problem, it is a fatal error. Use the nJ feature to skip over cells for which you do not want to enter values. The entry NO on the VOL card will bypass the volume calculation altogether. The  $x_i$  entries following NO are optional. If present,  $x_i$  entries are the volume values the code will use. For some problems the NO option saves considerable computer time.

Volumes or masses of cells are required for some tallies. MCNP calculates the volumes of all cells that are rotationally symmetric (generated by surfaces of revolution) about any axis, even a skew axis. It will also calculate the volumes of polyhedral cells. As a byproduct of the volume calculation, areas and masses are also calculated. These volumes, areas, and masses can be printed in the OUTP file by using the PRINT card. The user can enter values on the VOL card for the volume of any cell and these values, instead of the calculated values, will be used for tally purposes. If a cell volume required for a tally cannot be calculated and is not entered on the VOL or SDn cards, a fatal error message is printed.

The VOL card provides an alternative way to enter volumes required by tallies. Normally the SDn card would be used. The VOL card can be used only for cell volumes, whereas the SDn card can be used for cell and segment volumes or masses.

Volumes of cells or segments that cannot be calculated by MCNP or by the user can be obtained in a separate MCNP run using the ray-tracing technique described on page 2–183.

### 2. AREA Surface Area Card

Form: AREA       $x_1 \dots x_i \dots x_n$

$x_i$  = area of surface  $i$  where  $i=1, 2, \dots$  number of surfaces in the problem.

Default: MCNP attempts to calculate the area of all surfaces. If no value is entered for a surface on the AREA card, the calculated area, if any, is used.

Use: Optional card used to input surface areas.

This card is analogous to the VOL card. MCNP calculates the area of surfaces as a byproduct of the volume calculation. If the volume of all cells on either side of the surface can be calculated, the area of the surface will be calculated. Otherwise the area calculation will fail. A fatal error occurs if an area is required for tallying purposes and is not available either from the MCNP calculation or from an AREA or SDn card.

The AREA card provides an alternative way to enter areas required by tallies. Normally the SDn card would be used. The AREA card can be used only for areas of whole surfaces, whereas the SDn card can be used for areas of surface segments as well as whole surfaces.

### 3-6. Repeated Structures Cards

The primary goal of the repeated-structures capability is to make it possible to describe only once the cells and surfaces of any structure that appears more than once in a geometry. The amount of input data the user has to provide and the amount of computer memory needed by problems that have a lot of geometrical repetition is reduced. Problems that would be impractical because they take an unreasonable amount of work to set up or they use too much memory can be run. One example of such a problem is a reactor core that has dozens of nearly identical fuel modules. Another example is a room containing some complicated nearly identical objects arranged in some not necessarily regular order. This feature reduces input and memory use but problems won't run any faster than with any other description. Examples of the use of repeated structures cards are in Chapter 4.

The repeated structures capability extends the concept of an MCNP cell. The user can specify that a cell is to be filled with something called a universe. A universe is either a lattice or an arbitrary collection of cells. A single universe, described only once, can be designated to fill each of any number of cells in the geometry. Some or all of the cells in a universe may themselves be filled with universes. Several concepts and cards combine in order to use this capability.

- Remember that cell parameters can be defined on cell cards.
- The “*LIKE m BUT*” feature is a shorthand making it possible to make one cell equivalent to another except for assorted attributes that can be specified with keyword=value entries. See page 3-11.
- The *universe* card, the U card, is used to specify to what universe the cell belongs.
- The *fill* card is used to specify with which universe a cell is to be filled.
- The *TRCL* card makes it possible to define only once the surfaces that bound several cells identical in size and shape but located at different places in the geometry. It follows the transformation rules established for the TR card. See page 3-30.
- The *lattice* card, the LAT card, is used to define an infinite array of hexahedra or hexagonal prisms. The order of specification of the surfaces of a lattice cell identifies which lattice element lies beyond each surface.
- A general source description can be defined in a repeated structures part of the geometry. Surface source surfaces must be regular MCNP surfaces, not surfaces associated with a repeated structures part of the geometry. No check is made that this requirement is met. The user must remember and this notification is your only warning.
- An importance in a cell that is in a universe is interpreted as a multiplier of the importance of the filled cell. Weight-window lower bounds are handled the same way.

## CHAPTER 3

### DATA CARDS

Chapter 4 contains several examples that illustrate the repeated structures input and logic. The reader is strongly encouraged to become familiar with these examples and to use them as teaching aids to help understand the card descriptions that follow.

#### 3. U Universe Card

As mentioned earlier, a universe can be either a lattice or a collection of ordinary cells. A nonzero entry on the U card is the number of the universe that the corresponding cell belongs to. Lack of a U card or a zero entry means that the cell does not belong to any universe. Universe numbers are arbitrary integers chosen by the user. The FILL card, page 3–29, indicates that a cell is filled by all the cells having a corresponding integer entry on the U card. The cells of a universe may be finite or infinite, but they must fill all of the space inside any cell that the universe is specified to fill.

One way to think about the connection between a filled cell and the filling universe is that the filled cell is a “window” that looks into a second level, like a window in a wall provides a view of the outdoors. Cells in the second level can be infinite because they will be “ended” when they bump into or intersect the surfaces of the “window.” The second level can have its own origin, in a primed coordinate system, unrelated to the upper level origin. However, if the filled cell and filling universe have all their surfaces in the same coordinate system, one TRCL card, explained on page 3–27, will define the coordinate system of both filled and filling cells. The first repeated structures example in Chapter 4 illustrates this fact.

A cell in a universe can be filled by another universe, in which case a third level is introduced. There is a maximum of 10 levels, more than most problems will need. To clarify some jargon about hierarchies, the highest to lowest level is in inverse order to the associated numerical value. The highest level is level zero, lower is level one, lower still is level two, etc.

Planar surfaces of a filled cell and those in a filling universe CAN be coincident. In other words, the cells of a universe can fit exactly into the filled cell. The following cell and surface cards illustrate this feature. They represent a  $50 \times 20 \times 10$ -cm box filled with a lattice of  $10 \times 10 \times 10$ -cm cubes, each of which is filled with a sphere.

A problem will run faster by preceding the U card entry with a minus sign for any cell that is not truncated by the boundary of any higher level cell. The minus sign indicates that calculating distances to boundary in higher level cells can be omitted. In the problem below, cell 3 has a negative universe number. It is a finite cell and is not truncated by any other cell. Cell 4 cannot have a negative universe number because it is an infinite region that is truncated by cell 2.

**CAUTION:** Use this capability AT YOUR OWN RISK. MCNP cannot detect errors in this feature as the logic that enables detection is omitted by the presence of the negative universe. Extremely wrong answers can be quietly calculated. Use this feature with EXTREME caution. Plot several views of the geometry or run with the VOID card (see page 3–8) to check for errors.

```

1  0  1 -2 -3 4 -5 6    fill=1
2  0  -7 1 -3 8    u=1  fill=2  lat=1
3  0  -11          u=-2
4  0  11           u=2
5  0  -1:2:3:-4:5:-6

1  px  0
2  px  50
3  py  10
4  py -10
5  pz  5
6  pz -5
7  px  10
8  py  0
10 py  10
11 s   5 5 0 4

```

Every cell in the problem is either part of the real world (universe level 0) or part of some universe, but the surfaces of a problem are less restricted. A single planar surface can be used to describe cells in more than one universe. Coincident surfaces can not be reflecting or periodic, source surfaces, or tally surfaces. Materials are normally put into the cells of the lowest level universe, not in the higher level but there is an exception in the case of a lattice.

The above example can be described with macrobodies as follows:

```

1  0  -20  fill=1
2  0  -30  u=1  fill=2  lat=1
3  0  -11  u=-2
4  0   11  u=2
5  0   20

20 rpp  0 50 -10 10 -5 5
30 rpp  0 10  0 10
11 s    5 5 0 4

```

#### 4. TRCL Cell Transformation Card

The TRCL card makes it possible to describe just once the surfaces that bound several cells identical in size and shape but located at different places in the geometry. It is especially valuable when these cells are filled with the same universe. If the surfaces of these filled cells and the surfaces of the cells in the universe that fills them are all described in the same auxiliary coordinate system, a single transformation will completely define the interior of all these filled cells because the cells of the universe will inherit the transformation of the cells they fill. TRCL is intended to be

## CHAPTER 3 DATA CARDS

used with LIKE BUT, LAT, etc. With a regular cell description, it is suggested the TR on the surface cards be used.

The basic form of an entry is an integer that is interpreted as the number of a TR card that contains a transformation for all of the surfaces of the cell and is located in the data card section of the INP file. The absence of the TRCL card or zero means there is no transformation, the default. The actual transformation can be entered following the TRCL mnemonic, enclosed by parentheses. If the actual transformation is entered, all the rules applying to the TR card (page 3–30) are valid. If the symbol \*TRCL is used, the rotation matrix entries are angles in degrees instead of cosines, the same as the \*TR card.

If a cell has a transformation, a set of new surfaces with unique names is generated from the original surfaces. The name of the generated surface is equal to the name of the original surface plus 1000 times the name of the cell. This formula gives generated names that are predictable and can be used on other cell cards and on tally cards. This method limits cell names and original surface names to no more than three digits, however. These generated surfaces are only the bounding surfaces of the transformed cell, not the surfaces of any universe that fills it. MCNP requires only one full description of each universe, no matter how many times that universe is referenced in the problem.

### 5. LAT Lattice Card

LAT=1 means the lattice is made of hexahedra, solids with six faces. LAT=2 means the lattice is made of hexagonal prisms, solids with eight faces. A nonzero entry on the LAT card means that the corresponding cell is the (0,0,0) element of a lattice. The cell description of a lattice cell has two main purposes. It is a standard MCNP cell description and the order of specification of the surfaces of the cell identifies which lattice element lies beyond each surface.

After you have designed your lattice, decide which element you want to be the (0,0,0) element and in which directions in the lattice you want the three lattice indices to increase. In the case of a hexagonal prism lattice you have two constraints: the first and second indices must increase across adjacent surfaces and the third index must increase in one or the other direction along the length of the prism. You will then enter the bounding surfaces of the (0,0,0) element on the cell card in the right order, in accordance with the following conventions. For a hexahedral lattice cell, beyond the first surface listed is the (1,0,0) element, beyond the second surface listed is the (-1,0,0) element, then the (0,1,0), (0,-1,0), (0,0,1) and (0,0,-1) lattice elements in that order. This method provides the order of arrangement of the lattice to the code so that when you specify element (7,9,3), the code knows which one that is. For a hexagonal prism lattice cell, on the opposite side of the first surface listed is element (1,0,0), opposite the second listed surface is (-1,0,0), then (0,1,0), (0,-1,0), (-1,1,0), (1,-1,0), (0,0,1), and (0,0,-1). These last two surfaces must be the base surfaces of the prism. Example 7, page 4–34, illustrates a hexagonal prism lattice cell.

The hexahedra need not be rectangular and the hexagonal prisms need not be regular, but the lattices made out of them must fill space exactly. This means that opposite sides have to be identical and parallel. A hexahedral lattice cell may be infinite in one or two of its dimensions. A hexagonal prism lattice cell may be infinite in the direction along the length of the prism. The cross section must be convex (no butterflies). It does not matter whether the lattice is left-handed or right-handed. A lattice must be the only thing in its universe. The real world (universe level 0) itself can be a lattice. If a particle leaves the last cell of a real-world, limited-extent lattice (see the FILL card for how the extent of a lattice can be limited), it is killed (escapes).

## 6. FILL Fill Card

A nonzero entry on the FILL card indicates the number of the universe that fills the corresponding cell. The same number on the U card identifies the cells making up the filling universe. The FILL entry may optionally be followed by, in parentheses, either a transformation number or the transformation itself. This transformation is between the coordinate systems of the filled cell and the filling universe, with the universe considered to be in the auxiliary coordinate system. If no transformation is specified, the universe inherits the transformation, if any, of the filled cell. A \*FILL may be used if the rotation matrix entries are angles in degrees rather than cosines. In the data card section of the INP file you cannot have both a FILL and a \*FILL entry. If you want to enter some angles by degrees (\*FILL) and some angles by cosines (FILL), all FILL and \*FILL data must be placed on the cell cards of the INP file.

If the filled cell is a lattice, the FILL specification can be either a single entry, as described above, or an array. If it is a single entry, every cell of the lattice is filled by the same universe. If it is an array, the portion of the lattice covered by the array is filled and the rest of the lattice does not exist. It is possible to fill various elements of the lattice with different universes, as shown below and in examples in Chapter 4, section III,

The array specification for a cell filled by a lattice has three dimension declarators followed by the array values themselves. The dimension declarators define the ranges of the three lattice indices. They are in the same form as in FORTRAN, but both lower and upper bounds must be explicitly stated with positive, negative, or zero integers, separated by a colon. The indices of each lattice element are determined by its location with respect to the (0,0,0) element. Reread the LAT card section, if needed, with particular emphasis on how the order of specification of the surfaces of the cell identifies the ordering of the lattice elements. The first two surfaces listed on the cell card define the direction the first lattice index must cover. The numerical range of the indices depends on where in the lattice the (0,0,0) element is located. For example,  $-5:5$ ,  $0:10$ , and  $-10:0$  all define a range of 11 elements. The third and fourth surfaces listed in the cell description define the direction of the second lattice index.

The array values follow the dimension declarators. Each element in the array corresponds to an element in the lattice. Only those elements of the lattice that correspond to elements in the array



**CHAPTER 3  
DATA CARDS**

actually exist. The value of each array element is the number of the universe that is to fill the corresponding lattice. There are two values that can be used in the array that have special meanings. A zero in a real world (level zero) lattice means that the lattice element does not exist, making it possible, in effect, to specify a nonrectangular array. If the array value is the same as the number of the universe of the lattice, that element is not filled with any universe but with the material specified on the cell card for the lattice cell. A real world (level zero) lattice, by default, is universe zero and only can be universe zero. Therefore, using the universe number of the lattice as an array value to fill that element with the cell material is not possible. As with a single entry FILL specification, any value in the array optionally can be followed by, in parentheses, a transformation number or the transformation itself.

Example: FILL=0:2 1:2 0:1 4 4 2 0 4 0 4 3 3 0 4 0

Only eight elements of this lattice exist. Elements (0,1,0), (1,1,0), (1,2,0), (0,1,1) and (1,2,1) are filled with universe 4. Element (2,1,0) is filled with universe 2. Elements (1,1,1) and (2,1,1) are filled with universe 3.

7. TRn Coordinate Transformation Card

Form: TRn  $O_1$   $O_2$   $O_3$   $B_1$   $B_2$   $B_3$   $B_4$   $B_5$   $B_6$   $B_7$   $B_8$   $B_9$   $M$

$n$  = number of the transformation:  $1 < n < 999$ . \*TRn means that the  $B_i$  are angles in degrees rather than being the cosines of the angles.

$O_1$   $O_2$   $O_3$  = displacement vector of the transformation.

$B_1$  to  $B_9$  = rotation matrix of the transformation.

$M$  = 1 (the default) means that the displacement vector is the location of the origin of the auxiliary coordinate system, defined in the main system.

= -1 means that the displacement vector is the location of the origin of the main coordinate system, defined in the auxiliary system.

Default: TRn 0 0 0 1 0 0 0 1 0 0 0 1 1

The maximum number of transformations in a single problem is 999. A cone of one sheet can be rotated only from being on or parallel to one coordinate axis to being on or parallel to another coordinate axis (multiples of  $90^\circ$ ). A cone of one sheet can have any origin displacement vector appropriate to the problem. A cone of two sheets can be transformed anywhere. A cone of two sheets with an ambiguity surface in the cell description to cut off one half (the cell looks like one sheet) can be transformed. The ambiguity surface must have the same transformation number as the cone of two sheets. Ambiguity surfaces are described on page 2-12.

The  $B$  matrix specifies the relationship between the directions of the axes of the two coordinate systems.  $B_i$  is the cosine of the angle (or the angle itself, in degrees in the range from 0 to 180, if the optional asterisk is used) between an axis of the main coordinate system  $(x,y,z)$  and an axis of the auxiliary coordinate system  $x'y'z'$  as follows:

Element	$B_1$	$B_2$	$B_3$	$B_4$	$B_5$	$B_6$	$B_7$	$B_8$	$B_9$
Axes	$x,x'$	$y,x'$	$z,x'$	$x,y'$	$y,y'$	$z,y'$	$x,z'$	$y,z'$	$z,z'$

The meanings of the  $B_i$  do not depend on M. It is usually not necessary to enter all of the elements of the  $B$  matrix. These patterns are acceptable:

1. All nine elements.
2. Two of the three vectors either way in the matrix (6 values). MCNP will create the third vector by cross product.
3. One vector each way in the matrix (5 values). The component in common must be less than 1. MCNP will fill out the matrix by the Eulerian angles scheme.
4. One vector (3 values). MCNP will create the other two vectors in some arbitrary way.
5. None. MCNP will create the identity matrix.

A vector consists of the three elements in either a row or a column in the matrix. In all cases MCNP cleans up any small nonorthogonality and normalizes the matrix. In this process, exact vectors like  $(1,0,0)$  are left unchanged. A warning message is issued if the nonorthogonality is more than about 0.001 radian.

Pattern #5 is appropriate when the transformation is a pure translation. Pattern #4 is appropriate when the auxiliary coordinate system is being used to describe a set of surfaces that are all surfaces of rotation about a common skew axis. Patterns 2 and 3 are about equally useful in more general cases. Pattern #1 is required if one of the systems is right handed and the other is left handed.

Coordinate transformations in MCNP are used to simplify the geometrical description of surfaces and to relate the coordinate system of a surface source problem to the coordinate system of the problem that wrote the surface source file. See the surface source SSR card on page 3–66. Periodic boundary surfaces cannot have surface transformations.

To use a transformation to simplify the description of a surface, choose an auxiliary coordinate system in which the description of the surface is easy, include a transformation number  $n$  on the surface card, and specify the transformation on a TR $n$  card. See page 4–16 for an example showing how much easier it is to specify a skewed cylinder this way than as a GQ surface. Often a whole cluster of cells will have a common natural coordinate system. All of their surfaces can be described in that system, which can then be specified by a single TR $n$  card.

**CHAPTER 3  
DATA CARDS**

Example: 17 4 PX 5  
TR4 7 .9 1.3 0 -1 0 0 0 1 -1 0 0

Surface 17 is set up in an auxiliary coordinate system that is related to the main coordinate system by transformation number 4. (Presumably there are many other surfaces in this problem that are using the same transformation, probably because they came from the input file of an earlier problem. Otherwise there would be no reason to use a transformation to set up a surface as simple as a plane perpendicular to a coordinate axis.) MCNP will produce coefficients in the main coordinate system as if surface 17 had been entered as

17 P 0 -1 0 4.1

It will not produce

17 PY 4.1

that is located at the same place in space, because this PY surface has the wrong sense. More examples of the transformation are in Chapter 4.

**C. Variance Reduction**

The following cards define parameters for variance reduction cards.

<u>Mnemonic</u>	<u>Card Type</u>	<u>Page</u>
IMP	Cell importances	3-33
ESPLT	Energy splitting and roulette	3-34
PWT	Photon production weights	3-35
EXT	Exponential transform	3-36
VECT	Vector input	3-38
FCL	Forced collision	3-38
WWE	Weight window energies	3-40
WWN	Weight window bounds	3-40
WWP	Weight window parameter	3-41
WWG	Weight window generation	3-43
WWGE	Weight window generation energies	3-44
MESH	Superimposed importance mesh for mesh-based weight window generator	3-44
PD	Detector contribution to tally	3-47
DXC	DXTRAN cell contributions	3-48
BBREM	Bremsstrahlung biasing	3-48

Either an IMP or WWN card is required; most of the other cards are for optional variance reduction techniques.

Entries on a cell or surface parameter card correspond in order to the cell or surface cards that appear earlier in the INP file. To get to the particular cell(s) or surface(s) on a card, you must supply the appropriate default values on the cards as spacers (the nR repeat or nJ jump features may help). The number of entries on a cell or surface parameter card should always equal the number of cells or surfaces in the problem or a FATAL error will result.

Many of these cards require a knowledge of both the Monte Carlo method and the particular variance reduction technique being used. Chapter 2 and some of the references listed at the end of the manual may provide some of this knowledge.

1. IMP Cell Importance Cards

Form:       IMP:n        $x_1$   $x_2$  ...  $x_i$  ...  $x_I$

n           =  $N$  for neutrons,  $P$  for photons,  $E$  for electrons.  $N,P$  or  $P,E$  or  $N,P,E$   
              is allowed if importances are the same for different particle types.

$x_i$        = importance for cell  $i$

I           = number of cells in the problem

Default:    If an IMP:P card is omitted in a MODE N P problem, all photon cell importances are set to unity unless the neutron importance is 0. Then the photon importance is 0 also.

Use:        An IMP:n card is required with an entry for every cell unless a WWN weight window bound card is used.

The importance of a cell is used to terminate the particle's history if the importance is zero, for geometry splitting and Russian roulette as described on page 2–135 to help particles move to more important regions of the geometry, and in the weight cutoff game described on page 3–124. An importance in a cell that is in a universe is interpreted as a multiplier of the importance of the filled cell.

Neutrons, photons, and electrons can be split differently by having separate IMP:N, IMP:P, and IMP:E cards. It is a fatal error if the number of entries on any IMP:n card is not equal to the number of cells in the problem. The nJ feature is allowed and provides the default importance of zero. The nR repeat and nM multiply features are especially useful with this card.

Example:    IMP:N    1   2   2M   0   1   20R

## CHAPTER 3 DATA CARDS

The neutron importance of cell 1 is 1, cell 2 is 2, cell 3 is 4, cell 4 is 0, and cells 5 through 25 is 1. A track will be split 2 for 1 going from cell 2 into cell 3, each new track having half the weight of the original track before splitting. A track moving in the opposite direction will be terminated in about half (that is, probability=0.5) the cases but followed in the remaining cases with twice the weight.

Remember that both tracks and contributions to detectors and DXTRAN spheres are killed in cells of zero importance.

A track will neither be split nor rouletted when it enters a void cell even if the importance ratio of the adjacent cells would normally call for a split or roulette. However, the importance of the nonvoid cell it left is remembered and splitting or Russian roulette will be played when the particle next enters a nonvoid cell. As an example of the benefit of not splitting into a void, consider a long, void pipe surrounded by a material like concrete where the importances are decreasing radially away from the pipe. Considerable computer time can be wasted by tracks bouncing back and forth across the pipe and doing nothing but splitting then immediately undergoing roulette. Splitting into a void increases the time per history but has no counterbalancing effect on the expected history variance. Thus the *FOM* is reduced by the increased time per history.

If a superimposed weight window mesh is used, the IMP card is required but splitting/Russian roulette is not done at surfaces. Cell importances are only used for the weight cutoff game in zero-window meshes.

### 2. ESPLT Energy Splitting and Roulette Card

Form: ESPLT:n       $N_1$   $E_1$  ...  $N_5$   $E_5$

n      =  $N$  for neutrons,  $P$  for photons,  $E$  for electrons.

$N_i$     = number of tracks into which a particle will be split.

$E_i$     = energy (MeV) at which particles are to undergo splitting.

Default: Omission of this card means that energy splitting will not take place for those particles for which the card is omitted.

Use:      Optional; use energy-dependent weight windows instead.

The ESPLT card allows for splitting and Russian roulette in energy, as the IMP card allows for splitting and Russian roulette as a function of geometry. Energy splitting can result in low weight particles that are inadvertently killed by the weight cutoff game (CUT card). Because energy dependent weight windows perform the same function as the ESPLT card, are not limited to five energy groups, can have spatial dependence, and are more compatible with other variance reduction features, use of the ESPLT card is discouraged.

The entries on this card consist of pairs of energy-biasing parameters,  $N_i$  and  $E_i$ , with a maximum of five pairs allowed.  $N_i$  can be noninteger and also can be between 0 and 1, in which case Russian roulette on energy is played. For  $N_i$  between 0 and 1 the quantity becomes the survival probability in the roulette game.

If the particle's energy falls below  $E_i$ , the specified splitting or roulette always occurs. If the particle's energy increases above  $E_i$ , the inverse game is normally played. For example, suppose roulette is specified at 1 eV with survival probability 0.5; if a particle's energy increases above 1 eV, it is split 2 for 1.

A neutron's energy may increase by fission or from thermal up-scattering. There are cases when it may not be desirable to have the inverse splitting or roulette game played on energy increases (particularly in a fission-dominated problem). If  $N_i < 0$ , then splitting or roulette will be played only for energy decreases and not for energy increases.

Example: ESPLT:N 2 .1 2 .01 .25 .001

This example specifies a 2 for 1 split when the neutron energy falls below 0.1 MeV, another 2 for 1 split when the energy falls below 0.01 MeV, and Russian roulette when the energy falls below 0.001 MeV with a 25% chance of surviving.

### 3. PWT Photon Weight Card

Form: PWT  $W_1$   $W_2$  ...  $W_i$  ...  $W_I$

$W_i$  = relative threshold weight of photons produced at neutron collisions in cell  $i$   
 $I$  = number of cells in the problem.

Use: Recommended for MODE N P and MODE N P E problems without weight windows.

The PWT card is used in Mode N P or Mode N P E problems. Its purpose is to control the number and weight of neutron-induced photons produced at neutron collisions. Only prompt photons are produced from neutron collisions. Delayed gammas are neglected by MCNP. The PWT card application is further discussed on page 2–33.

For each cell with a positive  $W_i$  entry, only neutron-induced photons with weights greater than  $W_i * I_s / I_i$  are produced, where  $I_s$  and  $I_i$  are the neutron importances of the collision and source cells, respectively. Russian roulette is played to determine if a neutron-induced photon with a weight below this value survives.

For each cell with a negative  $W_i$  entry, only neutron-induced photons with weights greater than  $-W_i * W_s * I_s / I_i$  are produced, where  $W_s$  is the starting weight of the neutron for the history being

## CHAPTER 3 DATA CARDS

followed, and  $I_s$  and  $I_i$  are the neutron importances of the collision and source cells, respectively. Russian roulette is played to determine if a neutron-induced photon with weight below this value survives.

If  $W_i = 0$ , exactly one photon will be generated at each neutron collision in cell  $i$ , provided that photon production is possible. If  $W_i = -1.0E6$ , photon production in cell  $i$  is turned off.

The PWT card controls the production of neutron-induced photons by comparing the total weight of photons produced with a relative threshold weight specified on the PWT card. This threshold weight is relative to the neutron cell importance and, if  $W_i < 0$ , to the source neutron weight. If more neutron-induced photons are desired, the absolute value of  $W_i$  should be lowered to reduce the weight and therefore increase the number of photons. If fewer neutron-induced photons are desired, the absolute value of  $W_i$  should be increased.

For problems using photon cell importances (IMP:P), rather than photon weight windows (WWNn:P), a good first guess for PWT card entries is either the default value,  $W_i = -1$ , or set  $W_i$  in every cell to the average source weight.

For problems with photon weight windows, the PWT card is ignored and the correct number of photons are produced to be born within the weight windows.

### 4. EXT Exponential Transform Card

Form:        EXT:n         $A_1$   $A_2$  ...  $A_i$  ...  $A_I$

- n        =  $N$  for neutrons,  $P$  for photons, not available for electrons.
- $A_i$      = entry for cell  $i$ . Each entry  $A_i$  is of the form  $A = QVm$ , where  $Q$  describes the amount of stretching and  $Vm$  defines the stretching direction.
- I        = number of cells in the problem.

Default: No transform,  $A_i = 0$ .

Use:        Optional. Use cautiously. Weight windows strongly recommended.

The exponential transform should not be used in the same cell as forced collisions or without good weight control, such as the weight window. The transform works well only when the particle flux has an exponential distribution, such as in highly absorbing problems.

The exponential transform method stretches the path length between collisions in a preferred direction by adjusting the total cross section as follows:

$$\Sigma_t^* = \Sigma_t(1 - p\mu), \text{ where}$$

- $\Sigma_t^*$  = artificially adjusted total cross section;
- $\Sigma_t$  = true total cross section;
- $p$  = the stretching parameter; and
- $\mu$  = cosine of angle between particle direction and stretching direction.

The stretching parameter  $p$  can be specified by the stretching entry  $Q$  three ways:

- $Q = 0$  ;  $p = 0$       exponential transform not used
- $Q = p$  ;  $0 < p < 1$    constant stretching parameter
- $Q = S$  ;  $p = \Sigma_a / \Sigma_t$ , where  $\Sigma_a$  is the capture cross section.

Letting  $p = \Sigma_a / \Sigma_t$  can be used for implicit capture along a flight path, as described on page 2–36.

The stretching direction is defined by the  $Vm$  part of each  $A_i$  entry on the EXT card with three options.

1. Omit the  $Vm$  part of the  $A_i$  entry; that is, enter only the stretching entry  $A_i = Q$  for a given cell. This causes the stretching to be in the particle direction ( $\mu = 1$ ), independent of the particle direction and is not recommended unless you want to do implicit capture along a flight path, in which case  $A_i = Q = S$  and the distance to scatter rather than the distance to collision is sampled.
2. Specify the stretching direction as  $Vm$ , the line from the collision point to the point  $(x_{mp}, y_{mp}, z_m)$ , where  $(x_{mp}, y_{mp}, z_m)$  is specified on the VECT card (see next section). The direction cosine  $\mu$  is now the cosine of the angle between the particle direction and the line drawn from the collision point to point  $(x_{mp}, y_{mp}, z_m)$ . The sign of  $A_i$  governs whether stretching is toward or away from  $(x_{mp}, y_{mp}, z_m)$ .
3. Specify the stretching direction as  $Vm = X, Y, \text{ or } Z$ , so the direction cosine  $\mu$  is the cosine of the angle between the particle direction and the  $X$ -,  $Y$ -, or  $Z$ -axis, respectively. The sign of  $A_i$  governs whether stretching is toward or away from the  $X$ -,  $Y$ -, or  $Z$ -axis.

Example:    EXT:N   0   0   .7V2   S   -SV2   -.6V9   0   .5V9   SZ   -.4X  
                   VECT   V9   0 0 0   V2   1 1 1

The 10 entries are for the 10 cells in this problem. Path length stretching is not turned on for photons or for cells 1, 2, and 7. Following is a summary of path length stretching in the other cells.



**CHAPTER 3  
DATA CARDS**

<u>cell</u>	<u><math>A_i</math></u>	<u><math>Q</math></u>	<u><math>V_m</math></u>	<u>stretching parameter</u>	<u>direction</u>
3	.7V2	.7	V2	$p = .7$	toward point (1,1,1)
4	S	S		$p = \Sigma_a/\Sigma_t$	particle direction
5	-SV2	S	-V2	$p = \Sigma_a/\Sigma_t$	away from point (1,1,1)
6	-.6V9	.6	-V9	$p = .6$	away from origin
8	.5V9	.5	V9	$p = .5$	toward origin
9	SZ	S	Z	$p = \Sigma_a/\Sigma_t$	along +Z-axis
10	-.4X	.4	-X	$p = .4$	along -X-axis

**5. VECT Vector Input Card**

Form: VECT  $V_m$   $x_m y_m z_m \dots V_n$   $x_n y_n z_n \dots$

$m, n$  = any numbers to uniquely identify vectors  $V_m, V_n \dots$

$x_m y_m z_m$  = coordinate triplets to define vector  $V_m$ .

Default: None.

Use: Optional.

The entries on the VECT card are quadruplets which define any number of vectors for either the exponential transform or user patches. See the EXT card (page 3–36) for a usage example.

**6. FCL Forced Collision Card**

Form: FCL: $n$   $x_1 x_2 \dots x_i \dots x_I$

$n$  =  $N$  for neutrons,  $P$  for photons, not available for electrons.

$x_i$  = forced collision control for cell  $i$ .  $-1 \leq x_i \leq 1$

$I$  = number of cells in the problem.

Default:  $x_i = 0$ , no forced collisions.

Use: Optional. Exercise caution.

The FCL card controls the forcing of neutron or photon collisions in each cell. This is particularly useful for generating contributions to point detectors or DXTRAN spheres. The weight window game at surfaces is not played when entering forced collision cells.

If  $x_i \neq 0$ , all particles entering cell  $i$  are split into collided and uncollided parts with the appropriate weight adjustment (see page 2-147). If  $|x_i| < 1$ , Russian roulette is played on the collided parts with survival probability  $|x_i|$  to keep the number of collided histories from getting too large. Fractional  $x_i$  entries are recommended if a number of forced collision cells are adjacent to each other.

If  $x_i < 0$ , the forced collision process applies only to particles entering the cell. After the forced collision, the weight cutoff is ignored and all subsequent collisions are handled in the usual analog manner. Weight windows are not ignored and are applied after contributions are made to detectors and DXTRAN spheres.

If  $x_i > 0$ , the forced collision process applies both to particles entering cell  $i$  and to the collided particles surviving the weight cutoff or weight window games. Particles will continue to be split into uncollided and (with probability  $|x_i|$ ) collided parts until killed by either weight cutoff or weight windows.

Usage tips:

Let  $x_i = 1$  or  $-1$  unless a number of forced collision cells are adjacent to each other or the number of forced collision particles produced is higher than desired. Then fractional values are usually needed.

When cell-based weight window bounds bracket the typical weight entering the cell, choose  $x_i > 0$ . When cell-based weight window bounds bracket the weight typical of forced collision particles, choose  $x_i < 0$ . For mesh-based windows,  $x_i > 0$  usually is recommended.

When using importances, use  $x_i > 0$  because  $x_i < 0$  turns off the weight cutoff game.

### 7-9. Weight Window Cards

Weight windows can be either cell-based or mesh-based. Mesh-based windows eliminate the need to subdivide geometries finely enough for importance functions.

Weight windows provide an alternative means to importances (IMP:n cards) and energy splitting (ESPLT:n cards) for specifying space and energy importance functions. They also can provide time-dependent importance functions. The advantages of weight windows are that they (1) provide an importance function in space and time or space and energy; (2) control particle weights; (3) are more compatible with other variance reduction features such as the exponential transform (EXT:n card); (4) can be applied at surface crossings, collisions, or both; (5) the severity of splitting or Russian roulette can be controlled; (6) can be turned off in selected space or energy regions; and (7) can be automatically generated by the weight window generator. The disadvantages are that (1) weight windows are not as straightforward as importances; and (2) when the source weight is

## CHAPTER 3 DATA CARDS

changed, the weight windows may have to be renormalized. You are strongly advised to read the section on weight windows in Chapter 2.

A cell-based weight-window lower bound in a cell that is in a universe is interpreted as a multiplier of the weight-window lower bound of the filled cell. Mesh-based windows are recommended in repeated structures.

### 7. WWE Weight Window Energies or Times

Form:       WWE:n      $E_1 E_2 \dots E_i \dots E_j; j \leq 99$

$n$        =  $N$  for neutrons,  $P$  for photons,  $E$  for electrons

$E_i$        = upper energy or time bound of  $i^{th}$  window

$E_{i-1}$    = lower energy or time bound of  $i^{th}$  window

$E_0$        = 0, by definition

Default:    If this card is omitted and the weight window is used, a single energy or time interval is established corresponding to the energy or time limits of the problem being run.

Use:         Optional. Use only with WWN card.

The WWE card defines the energy or time intervals for which weight window bounds will be specified on the WWN card. The minimum energy, which is not entered on the WWE card, is zero. The minimum time is  $-\infty$ . Whether energy or time is specified is determined by the 6th entry on the WWP card.

### 8. WWN Cell-Based Weight Window Bounds

Form:       WWNi:n      $w_{i1} w_{i2} \dots w_{ij} \dots w_{iJ}$

$n$        =  $N$  for neutrons,  $P$  for photons,  $E$  for electrons

$w_{ij}$    = lower weight bound in cell  $j$  and energy or time interval  $E_{i-1} < E < E_i$ ,  $E_0 = 0$ , as defined on the WWE card. If no WWE card,  $i = 1$ .

$J$        = number of cells in the problem.

Default:    None.

Use:         Weight windows (WWN and WWP cards) are required unless importances (IMP card) or mesh-based windows are used.

The WWN card specifies the lower weight bound of the space and energy dependent weight windows in cells. It must be used with the WWP card, and, if the weight windows are energy or

time dependent, with the WWE card. The IMP:n card should not be used if a WWN:n card, where n is the same particle type, is used.

If  $w_{ij} < 0$ , any particle entering cell  $j$  is killed. That is, negative entries correspond to zero importance. If negative entries are used for one energy group, they should be used for all the other energy groups in the same cell.

If  $w_{ij} > 0$ , particles entering or colliding in cell  $j$  are split or rouletted according to the options on the WWP card, described in the next section.

If  $w_{ij} = 0$ , the weight window game is turned off in cell  $j$  for energy bin  $i$  and the weight cutoff game is turned on with a 1-for-2 roulette limit. Sometimes it is useful to specify the weight cutoffs on the CUT card as the lowest permissible weights desired in the problem. Otherwise, too many particles entering cells with  $w_{ij} = 0$  may be killed by the weight cutoff. Usually the 1-for-2 roulette limitation is sufficient to use the default weight cutoffs, but caution is needed and the problem output file should be examined carefully. The capability to turn the weight window game off in various energy and spatial regions is useful when these regions cannot be characterized by a single importance function or set of weight window bounds.

In terms of the weight window, particle weight bounds are always absolute and not relative; you have to explicitly account for weight changes from any other variance reduction techniques such as source biasing. You must specify one lower weight bound per cell per energy interval. There must be no holes in the specification; that is, if WWNi is specified, WWNj for  $1 < j < i$  must also be specified.

```
Example 1:  WWE:N   E1   E2   E3
            WWN1:N  w11  w12  w13  w14
            WWN2:N  w21  w22  w23  w24
            WWN3:N  w31  w32  w33  w34
```

These cards define three energy or time intervals and the weight window bounds for a four-cell neutron problem.

```
Example 2:  WWN1:P   w11   w12   w13
```

This card, without an accompanying WWE card, defines an energy or time independent photon weight window for a three-cell problem.

## 9. WWP Weight Window Parameter Card

```
Form:  WWP:n   WUPN WSURVN MXSPLN MWHERE SWITCHN MTIME
n      = N for neutrons, P for photons, E for electrons
```

## CHAPTER 3 DATA CARDS

- WUPN = If the particle weight goes above WUPN times the lower weight bound, the particle will be split.  
Required:  $WUPN \geq 2$ .
- WSURVN = If the particle survives the Russian roulette game, its weight becomes  $\text{MIN}(WSURVN \text{ times the lower weight bound, } WGT * MXSPLN)$ .  
Required:  $1 < WSURVN < WUPN$ .
- MXSPLN = No particle will ever be split more than MXSPLN-for-one or be rouletted more harshly than one-in-MXSPLN.  
MXSPLN=2 in zero window cells or meshes.  
Required:  $MXSPLN > 1$ .
- MWHERE = decides where to check a particle's weight.  
-1 means check the weight at collisions only  
0 means check the weight at surfaces and collisions  
1 means check the weight at surfaces only
- SWITCHN = decides where to get the lower weight window bounds.  
< 0 means get them from an external WWINP file.  
0 means get them from WWNi cards.  
> 0 means set the lower weight window bounds equal to SWITCHN divided by the cell importances from the IMP card.
- MTIME = 0 energy dependent windows (WWE card)  
1 time dependent windows (WWE card)
- Defaults: WUPN=5; WSURVN=0.6\*WUPN; MXSPLN=5; MWHERE=0;  
SWITCHN=0, MTIME=0

Use: Weight windows are required unless importances are used.

The WWP card contains parameters that control use of the weight window lower bounds specified on the WWN cards, the IMP cards, or an external file, depending on the value of SWITCHN. Having SWITCHN > 0 and also having WWNi cards is a fatal error. If SWITCHN is zero, the lower weight window bounds must be specified with the WWNi cards. If SWITCHN < 0, an external WWINP file with either cell- or mesh-based lower weight window bounds must exist. This file name can be changed on the MCNP execution line using "WWINP = filename." The different formats of the WWINP file will indicate to the code whether the weight windows are cell or mesh based. For mesh-based weight windows, the mesh geometry will also be read from the WWINP file. The WWINP file format is provided in Appendix J.

### Using Existing Cell Importances to Specify the Lower Weight Bound

An energy-independent weight window can be specified using existing importances from the IMP card and setting the fifth entry (SWITCHN) on the WWP card to a positive constant C. If this option is selected, the lower weight bounds for the cells become C/I, where I is the cell importance. The remaining entries on the WWP card are entered as described above. A suggested value for C

is one in which source particles start within the weight window such as .25 times the source weight. If that is not possible, your window is probably too narrow or you need to respecify your source.

### 10–12. Weight Window Generation Cards

The weight window generator estimates the importances of the space-energy regions of phase space specified by the user. The space-energy weight window parameters are then calculated inversely proportional to the importances.

Recall that the cell-based generator estimates the average importance of a phase-space cell. If the cells are too large, the importance variation inside the cell will be large and the average importance will not represent the cell. Inadequate geometry specification also occurs with large importance differences between adjacent cells. Fortunately, the generator provides information about whether the geometry specification is adequate for sampling purposes. If geometries are inadequately subdivided for importances, mesh-based weight windows should be used.

The user is advised to become familiar with the section on the weight window in Chapter 2 before trying to use the weight window generator.

### 10. WWG Weight Window Generation

Form: WWG  $I_t$   $I_c$   $W_g$   $J$   $J$   $J$   $J$   $I_E$

- $I_t$  = problem tally number (n of the Fn card). The particular tally bin for which the weight window generator is optimized is defined by the TFn card.
- $I_c$  = invokes cell- or mesh-based weight window generator .  
  - > 0 means use the cell-based weight window generator with  $I_c$  as the reference cell (typically a source cell).
  - 0 means use the mesh-based weight window generator. (MESH card.)
- $W_g$  = value of the generated lower weight window bound for cell  $I_c$  or for the reference mesh (see MESH card).  
  - 0 means lower bound will be half the average source weight.
- $J$  = unused
- $I_E$  toggles energy- or time-dependent weight windows.  
  - 0 means interpret WWGE card as energy bins.
  - 1 means interpret WWGE card as time bins.

Default: No weight window values are generated.

Use: Optional.

The WWG card causes the optimum importance function for tally  $I_t$  to be generated. For the cell-based weight window generator, the importance function is written on WWE and WWNi cards that

## CHAPTER 3 DATA CARDS

are printed, evaluated, and summarized in the OUTF file and are also printed on the weight window generator output file WWOUT. For the mesh-based weight window generator, the importance function and the mesh description are written only on the WWOUT file. (The format of the mesh-based WWOUT file is provided in Appendix J.) In either case, the generated weight window importance function easily can be used in subsequent runs using SWITCHN < 0 on the WWP card. For many problems, this importance function is superior to anything an experienced user can guess on an IMP card. To generate energy- or time-dependent weight-windows, use the WWGE card described below.

### 11. WWGE Weight Window Generation Energies or Times

Form: WWGE:n  $E_1 E_2 \dots E_i \dots E_j; j \leq 15$

$n$  =  $N$  for neutrons,  $P$  for photons,  $E$  for electrons

$E_i$  = upper energy or time bound for weight window group to be generated,  $E_{i+1} > E_i$ .

Default: If this card is omitted and the weight window is used, a single energy or time interval will be established corresponding to the energy/time limits of the problem being run. If the card is present but has no entries, ten energy/time bins will be generated with energies/times of  $E_i = 10^{i-8}$  MeV/shake and  $j = 10$ . Both the single time/energy and the energy/time-dependent windows are generated.

Use: Optional.

If this card is present, time/energy-dependent weight windows are generated and written on the WWOUT file and, for cell-based weight windows, on the OUTF file. If  $I_E = 1$  on the WWG card, time-dependent windows are generated. In addition, single-group energy- or time-independent weight windows are written on a separate output file, WWONE. Energy- and time-independent weight windows are useful for trouble-shooting the energy- and time-dependent weight windows on the WWOUT file. The WWONE file format is the same as that of the WWOUT file provided in Appendix J.

### 12. MESH Superimposed Importance Mesh for Mesh-Based Weight Window Generator

Form: MESH mesh variable=specification

Use: Required if mesh-based weight windows are used or generated.

The equal sign is optional. Keywords can be entered in any order. Special input features I, M, and R can be used except with GEOM. Table 3.2 summarizes the superimposed mesh variables and lists their defaults. The default geometry is rectangular and the default ORIGIN point is (0,0,0). For a cylindrical mesh, the default cylindrical axis is parallel to the MCNP geometry  $z$  axis and the half-

plane defining  $\theta=0$  is the MCNP geometry positive  $x$  axis. The reference point must always be specified.

**TABLE 3.2: Superimposed Mesh Variables**

Variable	Meaning	Default
GEOM	Mesh geometry; either Cartesian (“xyz” or “rec”) or cylindrical (“rzt” or “cyl”).	xyz
REF	$x$ , $y$ , and $z$ coordinates of the reference point	None (variable must be present)
ORIGIN	$x$ , $y$ , and $z$ coordinates in MCNP cell geometry of the origin (bottom center for cylindrical or bottom, left, behind for rectangular) of the superimposed mesh	0., 0., 0.
AXS	vector giving the direction of the axis of the cylindrical mesh	0., 0., 1.
VEC	vector defining, along with AXS, the plane for $\theta=0$	1., 0., 0.
IMESH	locations of the coarse meshes in the $x$ direction for rectangular geometry or in the $r$ direction for cylindrical geometry	None
IINTS	number of fine meshes within corresponding coarse meshes in the $x$ direction for rectangular geometry or in the $r$ direction for cylindrical geometry	10 in each coarse mesh
JMESH	locations of the coarse meshes in the $y$ direction for rectangular geometry or in the $z$ direction for cylindrical geometry	None
JINTS	number of fine meshes within corresponding coarse meshes in the $y$ direction for rectangular geometry or in the $z$ direction for cylindrical geometry	10 in each coarse mesh
KMESH	locations of the coarse meshes in the $z$ direction for rectangular geometry or in the $\theta$ direction for cylindrical geometry	None
KINTS	number of fine meshes within corresponding coarse meshes in the $z$ direction for rectangular geometry or in the $\theta$ direction for cylindrical geometry	10 in each coarse mesh

The location of the  $n$ 'th coarse mesh in the  $u$  direction ( $ru_n$  in what follows) is given in terms of the most positive surface in the  $u$  direction. For a rectangular mesh, the coarse mesh locations  $rx_n$ ,  $ry_n$ , and  $rz_n$  are given as planes perpendicular to the  $x$ ,  $y$ , and  $z$  axes, respectively, in the MCNP cell coordinate system; thus, the ORIGIN point  $(x_0, y_0, z_0)$  is the most negative point of the mesh. For a cylindrical mesh,  $(r_0, z_0, \theta_0) = (0., 0., 0.)$ , corresponds to the bottom center point, which is the cylindrical ORIGIN point in MCNP cell geometry. The coarse mesh locations must increase monotonically (beginning with the ORIGIN point for a rectangular mesh).

The fine meshes are evenly distributed within the  $n$ 'th coarse mesh in the  $u$  direction. The mesh in which the reference point lies becomes the reference mesh for the mesh-based weight window



## CHAPTER 3

### DATA CARDS

generator; this reference mesh is analogous to the reference cell used by the cell-based weight window generator.

For a cylindrical mesh, the AXS and VEC vectors need not be orthogonal but they must not be parallel; the one half-plane that contains them and the ORIGIN point will define  $\theta = 0$ . The AXS vector will remain fixed. The length of the AXS or VEC vectors must not be zero. The  $\theta$  coarse mesh locations are given in revolutions and the last one must be 1.

At least two coarse meshes per coordinate direction must be specified using IMESH, JMESH, and KMESH keywords, but the code uses a default value of 10 fine meshes per coarse mesh if IINTS, JINTS, or KINTS keywords are omitted. If IINTS, JINTS, or KINTS keywords are present, the number of entries must match the number of entries on the IMESH, JMESH, and KMESH keywords, respectively. Entries on the IINTS, JINTS, and KINTS keywords must be greater than zero. A reference point must be specified using the REF keyword.

A second method of providing a superimposed mesh is to use one that already exists, either written on the WWOUT file or on the WWONE file. To implement this method, use the WWG card with  $I_c=0$  in conjunction with the MESH card where the only keyword is REF. The reference point must be within the superimposed mesh and must be provided because there is no reference point in either WWOUT or WWONE. If the mesh-based weight window generator is invoked by this method, MCNP expects to read a file called WWINP. WWOUT or WWONE can be renamed in the local filespace or the files can be equivalenced on the execution line using "WWINP=filename."

It is not necessary to use mesh-based weight windows from the WWINP file in order to use the mesh from that file. Furthermore, previously generated mesh-based weight windows can be used (WWP card with SWITCHN < 0 and WWINP file in mesh format) while the mesh-based weight window generator is simultaneously generating weight windows for a different mesh (input on the MESH card). However, it is not possible to read mesh-based weight windows from one file but a weight-window generation mesh from a different file.

The superimposed mesh should fully cover the problem geometry; i.e., the outer boundaries of the mesh should lie outside the outer boundaries of the geometry, rather than being coincident with them. This requirement guarantees that particles remain within the weight window mesh. A line or surface source should not be made coincident with a mesh surface. A point source should never be coincident with the intersection of mesh surfaces. In particular, a line or point source should never lie on the axis of a cylindrical mesh. These guidelines also apply to the WWG reference point specified using the REF keyword.

If a particle does escape the weight-window generation mesh, the code prints a warning message giving the coordinate direction and surface number (in that direction) from which the particle escaped; for example, "warning. particle escaped wwg mesh in z direction" (the mesh index number appears with NPS on the next line). The code prints the total number of particles escaping

the mesh (if any) after the tally fluctuation charts in the standard output file. Similarly, if a track starts outside the mesh, the code prints a warning message giving the coordinate direction that was missed and which side of the mesh the particle started on; for example, “warning. track started outside wwg mesh: x too great.” The code prints the total number of particles starting outside the mesh (if any) after the tally fluctuation charts in the standard output file.

$I_c = 0$  on the WWG card with no MESH card is a fatal error. If AXS or VEC keywords are present and the mesh is rectangular, a warning message is printed and the keyword is ignored. If there are fatal errors and the FATAL option is on, weight-window generation is disabled.

```
Example:  GEOM=cyl REF=1e-6 1e-7 0  ORIGIN=1 2 3
          IMESH 2.55 66.34
          IINTS  2   15  $ 2 fine bins from 0 to 2.55, 15 from 2.55 to 66.34
          JMESH 33.1 42.1 53.4 139.7
          JINTS  6   3   4   13
          KMESH  .5   1
          KINTS  5   5
```

```
Example:  GEOM=rec REF=1e-6 1e-7 0  ORIGIN=-66.34 -38.11 -60
          IMESH -16.5 3.8 53.66
          IINTS  10  3   8  $ 10 fine bins from -66.34 to -16.5, etc
```

### 13. PDn Detector Contribution Card

Form: PDn  $P_1$   $P_2$  ...  $P_i$  ...  $P_I$

$n$  = tally number

$P_i$  = probability of contribution to detector  $n$  from cell  $i$

$I$  = number of cells in the problem.

Default:  $P_i = 1$ .

Use: Optional. Consider also using the DD card, page 3-102.

The PDn card reduces the number of contributions to detector tallies from selected cells that are relatively unimportant to a given detector, thus saving computing time. At each collision in cell  $i$ , the detector tallies are made with probability  $P_i$  ( $0 \leq P_i \leq 1$ ). The tally is then increased by the factor  $1/P_i$  to obtain unbiased results for all cells except those where  $P_i = 0$ . This enables you to increase the running speed by setting  $P_i < 1$  for cells many mean free paths from the detectors. It also selectively eliminates detector contributions from cells by setting the  $P_i$ 's to zero.

A default set of probabilities can be established for all tallies by use of a PD0 (zero) card. These default values will be overridden for a specific tally  $n$  by values entered on a PDn card.

## CHAPTER 3 DATA CARDS

### 14. DXC DXTRAN Contribution Card

Form: DXCm:n  $P_1$   $P_2$  ...  $P_i$  ...  $P_I$

$m$  = which DXTRAN sphere the DXC card applies to. If 0 or absent, the DXC card applies to all the DXTRAN spheres in the problem.

$n$  =  $N$  for neutrons,  $P$  for photons, not available for electrons.

$P_i$  = probability of contribution to DXTRAN spheres from cell  $i$

$I$  = number of cells in the problem

Default:  $m = 0$ ,  $P_i = 1$ .

Use: Optional. Consider also using the DD card, page 3–102.

This card is analogous to the above PDn card but is used for contributions to DXTRAN spheres.

### 15. BBREM Bremsstrahlung Biasing Card

Form: BBREM  $b_1$   $b_2$   $b_3$  ...  $b_{49}$   $m_1$   $m_2$  ...  $m_n$

$b_1$  = any positive value (currently unused).

$b_2$  ...  $b_{49}$  = bias factors for the bremsstrahlung energy spectrum.

$m_1$  ...  $m_n$  = list of materials for which the biasing is invoked.

Default: None.

Use: Optional.

The bremsstrahlung process generates many low-energy photons, but the higher-energy photons are often of more interest. One way to generate more high-energy photon tracks is to bias each sampling of a bremsstrahlung photon toward a larger fraction of the available electron energy. For example, a bias such as

```
BBREM 1. 1. 46I 10. 888 999
```

would create a gradually increasing enhancement (from the lowest to the highest fraction of the electron energy available to a given event) of the probability that the sampled bremsstrahlung photon will carry a particular fraction of the electron energy. This biasing would apply to each instance of the sampling of a bremsstrahlung photon in materials 888 and 999. The sampling in other materials would remain unbiased. The bias factors are normalized by the code in a manner that depends both on material and on electron energy, so that although the ratios of the photon weight adjustments among the different groups are known, the actual number of photons produced in any group is not easily predictable. For the eI03 treatment, there are more than 49 relative photon energy ratios so the lower energy bins have a linear interpolation between  $b_1$  and  $b_2$  for their values.

In most problems the above prescription will increase the total number of bremsstrahlung photons produced because there will be more photon tracks generated at higher energies. The secondary electrons created by these photons will tend to have higher energies as well, and will therefore be able to create more bremsstrahlung tracks than they would at lower energies. This increase in the population of the electron-photon cascade will make the problem run more slowly. The benefits of better sampling of the high-energy domain must be balanced against this increase in run time.

For a more detailed discussion of the bremsstrahlung energy biasing scheme, see Chapter 2.

***D. Source Specification***

Every MCNP problem has one of four sources: general source (SDEF card), surface source (SSR card), criticality source (KCODE card), or user-supplied source (default if SDEF, SSR, and KCODE are all missing). All can use source distribution functions, specified on SIn, SPn, SBn, and DSn cards.

The following cards are used to specify the source.

<u>Mnemonic</u>	<u>Card Type</u>	<u>Page</u>
SDEF	General source	3-50
SIn	Source information	3-57
SPn	Source probability	3-58
SBn	Source bias	3-58
DSn	Dependent source	3-62
SCn	Source comment	3-63
SSW	Surface source write	3-65
SSR	Surface source read	3-66
KCODE	Criticality source	3-71
KSRC	Source points	3-71
ACODE	Alpha eigenvalue source	3-71

The MODE card also serves as part of the source specification in some cases by implying the type of particle to be started from the source.

The source has to define the values of the following MCNP variables for each particle it produces:

ERG	the energy of the particle (MeV). See * below
TME	the time when the particle started (shakes)
UUU, VVV, WWW	the direction of the flight of the particle
XXX, YYY, ZZZ	the position of the particle

## CHAPTER 3 DATA CARDS

IPT	the type of the particle
WGT	the statistical weight of the particle
ICL	the cell where the particle started
JSU	the surface where the particle started, or zero if the starting point is not on any surface

Additional variables may have to be defined if there are point detectors or DXTRAN spheres in the problem.

\*ERG has a different meaning in a special case. If there is a negative IGM on the MGOPT card, which indicates a special electron–photon multigroup problem, ERG on the SDEF card is interpreted as an energy group number, an integer.

### 1. SDEF General Source Card

Form: SDEF source variable = specification ...

Use: Required for problems using the general source. Optional for problems using the criticality source.

The equal signs are optional. The source variables are not quite the same as MCNP variables that the source must set. Many are intermediate quantities that control the sampling of the final variables. All have default values. The specification of a source variable has one of these three forms:

1. explicit value,
2. a distribution number prefixed by a D, or
3. the name of another variable prefixed by an F, followed by a distribution number prefixed by a D.  $\text{Var} = \text{Dn}$  means that the value of source variable var is sampled from distribution n.  $\text{Var} = \text{Fvar}' \text{Dn}$  means that var is sampled from distribution n that depends on the variable var'. Only one level of dependence is allowed. Each distribution may be used for only one source variable.

The above scheme translates into three levels of source description. The first level exists when a source variable has an explicit or default value (for example, a single energy) or a default distribution (for example, an isotropic angular distribution). The second level occurs when a source variable is given by a probability distribution. This level requires the SI and/or SP cards. The third level occurs when a variable depends on another variable. This level requires the DS card.

MCNP samples the source variables in an order set up according to the needs of the particular problem. Each dependent variable must be sampled after the variable it depends on has been sampled. If the value of one variable influences the default value of another variable or the way it

is sampled, as SUR influences DIR, they may have to be sampled in the right order. The scheme used in MCNP to set up the order of sampling is complicated and may not always work. If it fails, a message will be printed. The fix in such instances may be to use explicit values or distributions instead of depending on defaults.

Table 3.3 summarizes the source variables and lists their defaults.

**TABLE 3.3: Source Variables**

<u>Variable</u>	<u>Meaning</u>	<u>Default</u>
CEL	Cell	Determined from XXX,YYY,ZZZ and possibly UUU,VVV,WWW
SUR	Surface	Zero (means cell source)
ERG	Energy (MeV)	14 MeV
TME	Time (shakes)	0
DIR	$\mu$ , the cosine of the angle between VEC and UUU,VVV,WWW (Azimuthal angle is always sampled uniformly in $0^{\circ}$ to $360^{\circ}$ )	Volume case: $\mu$ is sampled uniformly in $-1$ to $1$ (isotropic) Surface case: $p(\mu) = 2\mu$ in $0$ to $1$ (cosine distribution)
VEC	Reference vector for DIR	Volume case: required unless isotropic Surface case: vector normal to the surface with sign determined by NRM
NRM	Sign of the surface normal	+ 1
POS	Reference point for position sampling	0,0,0
RAD	Radial distance of the position from POS or AXS	0
EXT	Cell case: distance from POS along AXS Surface case: Cosine of angle from AXS	0
AXS	Reference vector for EXT and RAD	No direction
X	x-coordinate of position	No X
Y	y-coordinate of position	No Y
Z	z-coordinate of position	No Z
CCC	Cookie-cutter cell	No cookie-cutter cell

## CHAPTER 3 DATA CARDS

ARA	Area of surface (required only for direct contributions to point detectors from plane surface source.)	None
WGT	Particle weight	1
EFF	Rejection efficiency criterion for position sampling	.01
PAR	Particle type source will emit	1=neutron if MODE N or N P or N P E 2=photon if MODE P or P E 3=electron if MODE E

The specification of WGT, EFF and PAR must be only an explicit value. A distribution is not allowed. The allowed value for PAR is 1 for neutron, 2 for photon, or 3 for electron. The default is the lowest of these three that corresponds to an actual or default entry on the MODE card. Only one kind of particle is allowed in an SDEF source.

Most of the source variables are scalars. VEC, POS, and AXS are vectors. Where a value of a source variable is required, as on SDEF, SI, or DS cards, usually a single number is appropriate, but with VEC, POS, and AXS, the value must actually be a triplet of numbers, the  $x$ ,  $y$ , and  $z$  components of the vector.

The source variables SUR, POS, RAD, EXT, AXS, X, Y, Z, and CCC are used in various combinations to determine the coordinates ( $x,y,z$ ) of the starting positions of the source particles. With them you can specify three different kinds of volume distributions and three different kinds of distributions on surfaces. Degenerate versions of those distributions provide line and point sources. More elaborate distributions can be approximated by combining several simple distributions, using the S option of the SIn and DS<sub>n</sub> cards.

The three volume distributions are cartesian, spherical, and cylindrical. The value of the variable SUR is zero for a volume distribution. A volume distribution can be used in combination with the CEL variable to sample uniformly throughout the interior of a cell. A cartesian, spherical, or cylindrical region that completely contains a cell is specified and is sampled uniformly in volume. If the sampled point is found to be inside the cell, it is accepted. Otherwise it is rejected and another point is sampled. If you use this technique, you must make sure that the sampling region really does contain every part of the cell because MCNP has no way of checking for this. Cookie-cutter rejection, described below, can be used instead of or in combination with CEL rejection.

A cartesian volume distribution is specified with the variables X, Y, and Z. A degenerate case of the cartesian distribution, in which the three variables are constants, defines a point source. A single point source can be specified by giving values to the three variables right on the SDEF card. If there are several source points in the problem, it would usually be easier to use a degenerate spherical

distribution for each point. Other degenerate cases of the cartesian distribution are a line source and a rectangular plane source. A cartesian distribution is an efficient shape for the CEL rejection technique when the cell is approximately rectangular. It is much better than a cylindrical distribution when the cell is a long thin slab. It is, however, limited in that its faces can only be perpendicular to the coordinate axes.

A spherical volume distribution is specified with the variables POS and RAD.  $X$ ,  $Y$ ,  $Z$ , and  $AXS$  must not be specified or it will be taken to be a cartesian or cylindrical distribution. The sampled value of the vector POS defines the center of the sphere. The sampled value of RAD defines the distance from the center of the sphere to the position of the particle. The position is then sampled uniformly on the surface of the sphere of radius RAD. Uniform sampling in volume is obtained if the distribution of RAD is a power law with  $a = 2$ , which is the default in this case. A common use of the spherical volume distribution is to sample uniformly in the volume between two spherical surfaces. The two radii are specified on the SIn card for RAD and the effect of a SPn -21 2 card is obtained by default (see page 3-58). If RAD is not specified, the default is zero. This is useful because it specifies a point source at the position POS. A distribution for POS, with an L on the SIn card, is the easiest way to specify a set of point sources in a problem.

A cylindrical volume distribution is specified with the variables POS,  $AXS$ , RAD, and EXT. The axis of the cylinder passes through the point POS in the direction  $AXS$ . The position of the particles is sampled uniformly on a circle whose radius is the sampled value of RAD, centered on the axis of the cylinder. The circle lies in a plane perpendicular to  $AXS$  at a distance from POS which is the sampled value of EXT. A common use of the cylindrical distribution is to sample uniformly in volume within a cylindrical shell. The distances of the ends of the cylinder from POS are entered on the SIn card for EXT and the inner and outer radii are entered on the SIn card for RAD. Uniform sampling between the two values of EXT and power law sampling between the two values of RAD, with  $a = 1$  which gives sampling uniform in volume, are provided by default. A useful degenerate case is EXT=0, which provides a source with circular symmetry on a plane.

Warning: Never position any kind of degenerate volume distribution in such a way that it lies on one of the defined surfaces of the problem geometry. Even a bounding surface that extends into the interior of a cell can cause trouble. If possible, use one of the surface distributions instead. Otherwise, move to a position just a little way off of the surface. It will not make any detectable difference in the answers, and it will prevent particles from getting lost.

The value of the variable SUR is nonzero for a distribution on a surface. If  $X$ ,  $Y$ , and  $Z$  are specified, their sampled values determine the position. You must in this case make sure that the point really is on the surface because MCNP does not check. If  $X$ ,  $Y$ , and  $Z$  are not specified, the position is sampled on the surface SUR. The shape of the surface, which can be either a spheroid, sphere, or plane, determines the way the position is sampled. Sampling with CEL rejection is not available, but cookie-cutter rejection can be used to do anything that CEL rejection would do. Cylindrical surface sources must be specified as degenerate volume sources.



## CHAPTER 3

### DATA CARDS

If the value of SUR is the name of a spheroidal surface, the position of the particle is sampled uniformly in area on the surface. A spheroid is an ellipse revolved around one of its axes. A spheroid for this purpose must have its axis parallel to one of the coordinate axes. There is presently no provision for easy nonuniform or biased sampling on a spheroidal surface. A distribution of cookie-cutter cells could be used to produce a crude nonuniform distribution of position.

If the value of SUR is the name of a spherical surface, the position of the particle is sampled on that surface. If the vector AXS is not specified, the position is sampled uniformly in area on the surface. If AXS is specified, the sampled value of EXT is used for the cosine of the angle between the direction AXS and the vector from the center of the sphere to the position point. The azimuthal angle is sampled uniformly in the range from  $0^\circ$  to  $360^\circ$ . A nonuniform distribution of position, in polar angle only, is available through a nonuniform distribution of EXT. A biased distribution of EXT can be used to start more particles from the side of the sphere nearest the tallying regions of the geometry. The exponential distribution function (-31; see page 3-61) is usually most appropriate for this.

If the value of SUR is the name of a plane surface, the position is sampled on that plane. The sampled value of POS must be a point on the plane. You must make sure that POS really is on the plane because MCNP, for the sake of speed, does not check it. The sampled position of the particle is at a distance from POS equal to the sampled value of RAD. The position is sampled uniformly on the circle of radius RAD centered on POS. Uniform sampling in area is obtained if the distribution of RAD is a power law with  $a = 1$ , which is the default in this case.

Cookie-cutter rejection is available for both cell and surface sources. If CCC is present, the position sampled by the above procedures is accepted if it is within cell CCC and is resampled if it is not, exactly like CEL rejection in the cell source case. You must be careful not to specify a cookie-cutter cell such that MCNP mistakes it for a real cell. There should be no trouble if the cookie-cutter cells are bounded by surfaces used for no other purpose in the problem and if the cookie-cutter cell cards are at the end of the list of cell cards. Don't make a cookie-cutter cell more complicated than it has to be. For a surface source, the only thing that matters is the intersection of the cookie-cutter cell with the source surface. An infinitely long cell of uniform cross section, bounded by planes and cylinders, is usually adequate for a plane surface source.

Warning: The combination of either CEL or CCC rejection with biased sampling of the position is nearly always an unfair game. If you use this combination, you must make sure that it really is a fair game because MCNP is not able to detect the error.

The source variables SUR, VEC, NRM, and DIR are used to determine the initial direction of flight of the source particles. The direction of flight is sampled with respect to the reference vector VEC, which, of course, can itself be sampled from a distribution. The polar angle is the sampled value of the variable DIR. The azimuthal angle is sampled uniformly in the range from  $0^\circ$  to  $360^\circ$ . If VEC and DIR are not specified for a volume distribution of position (SUR=0), an isotropic distribution

of direction is produced by default. If VEC is not specified for a distribution on a surface (SUR ≠ 0), the vector normal to the surface, with the sign determined by the sign of NRM, is used by default. If DIR is not specified for a distribution on a surface, the cosine distribution  $p(\text{DIR})=2*\text{DIR}$ ,  $0<\text{DIR}<1$ , is used by default. A biased distribution of DIR can be used to make more source particles start in a direction towards the tallying regions of the geometry. The exponential distribution function (–31; see page 3–61) is usually most appropriate for this.

Discrete values of DIR are allowed. DIR=1 gives a monodirectional source in the direction of VEC. This is sometimes useful as an approximation to an actual source that is at a large distance from the geometry of the problem. In most cases discrete values of DIR will prevent direct contributions to point detectors from being scored. The direct contribution will be scored only if the source is on a plane surface, is sampled uniformly in area within a circle (using RAD sampled from SP –21 1), VEC is perpendicular to the surface (the default), and DIR=1. A cookie-cutter cell is allowed and a value of ARA is necessary. Discrete values of DIR with DXTRAN are generally wrong because  $p(\mu) = .5$  is assumed. See page 2–152.

The efficiency criterion EFF applies to both CCC and CEL rejection. If in any source cell or cookie-cutter cell the acceptance rate is too low, the problem is terminated for inefficiency. The criterion for termination is  $\text{MAX}(\text{number of successes}, 10) < \text{EFF} * \text{number of tries}$ . The default value of EFF, 0.01, lets a problem get by at rather low efficiency, but for the rare problem in which low source efficiency is unavoidable, you may need to specify a lower value for EFF.

This section discusses a source in a geometry that we will call a repeated structure and is one that includes FILL, U, or LAT cards. We strongly emphasize that print table 110 should be studied carefully to ensure that the proper source path and position are being sampled when repeated structures are used in a source description.

Warning: Defining a source on a lattice cell bounding plane or on a “window” cell plane coincident with a lattice surface generally does not work and is not recommended.

The only part of the MCNP source specification that is different when the source is in a repeated structure part of the geometry is the use of the CEL parameter on the SDEF card. CEL must have a value that is a path from level 0 to level n, which is not necessarily the bottom:

$$c_0 : c_1 : \dots : c_n$$

$c_i$  is a cell in the universe that fills cell  $c_{i-1}$ , or is zero, or is Dm for a distribution of cells in the repeated structure case. Dm is not valid for a lattice.  $c_i$  can have a minus sign and is discussed more below. Dm cannot have a minus sign. If  $c_i = 0$ , the cell at that level is searched for. Recall that level n is not necessarily the bottom level in the problem. If  $c_i$  is one specific element in a lattice, it is indicated as:  $\dots : c_i (j_1 j_2 j_3) : \dots$

**CHAPTER 3  
DATA CARDS**

The coordinate system for **p**osition and **d**irection **s**ampling (pds) is the coordinate system of the first negative or zero  $c_i$  in the source path. Each entry in the source path represents a geometry level, where level zero is the first source path entry, level one the second, etc., and level zero is above level one, level two is below level one. The pds level is the level associated with the pds cell or pds coordinate system. All levels above the pds level must be included in the source path. Levels below the pds level need not be specified, and when given, may include one or more zero entries. The default pds level is the last entry in the source path when the path has no negative or zero entry.

Position rejection is done in cells at all levels where  $c_i \neq 0$ , but if any  $c_i$  has a negative universe number on its cell card and is at or above the pds level, higher level cells are not checked.

The following chart illustrates the idea of the pds level.

<u>CEL Source Path</u>	<u>Cell of pds Level</u>	<u>pds Level</u>
8:7:6:5	5	3
8:-7:6	7	1
8:7:-6:0:4:0	6	2
8:-(1 0 0):6(0 0 0):0	7	1
8:7(1 0 0):6(0 0 0):0	Will be determined	3

Lattice cell elements that are defined using the expanded FILL card (see page 3-29) can be uniformly sampled automatically. This feature is applied to lattice cell entries in the source path that lack an explicit lattice index AND that are *at or above* the pds level. Lattice cells not defined by the expanded FILL card must include an explicit lattice index when at or above the pds level. Rejection of automatically sampled lattice elements depends on the entry after the lattice cell number in the source path.

Assume the following cell cards:

```

7 0 surfaces lat=1 u=1 fill=0:2 0:0 0:0 1 2 3
cells 8 and 9 belong to universe 2
cells 10 and 11 belong to universe 3

```

Cell 7 is a lattice with three existing elements: (0 0 0) is filled by itself [u=1], (1 0 0) is filled by cells 8 and 9 [u=2], and (2 0 0) is filled by cells 10 and 11 [u=3]. The following combinations show what elements are accepted and what are rejected.

<u>CEL Source Path</u>	<u>Accepted</u>	<u>Rejected</u>
7	All elements	None
7:0	All elements	None
7:8	(1 0 0)	(0 0 0), (2 0 0)
7:10	(2 0 0)	(0 0 0), (1 0 0)

The sampling efficiency for cell 7 in the OUTP file will reflect the element rejections. Lattice cell entries that lack an explicit lattice index AND are *below* the pds level are not sampled. Instead, the appropriate lattice element is determined by the input source position.

Lattice element sampling is independent from position sampling. First a lattice element is chosen, then a position is chosen. If the sampled position is not in the sampled lattice element, the position is resampled until it is in the specified source path and in the lattice element chosen or until an efficiency error occurs. The lattice elements will not be resampled to accommodate the sampled position. Lattice element rejection is done only as described above.

Using the previous description of lattice cell 7, add that cell 6 is filled by cell 7. The source path becomes 6:7:0. Three elements of the lattice exist [fill=0:2 0:0 0:0] but element (0 0 0) now is cut off by cell 6. Lattice element (0 0 0) still will be sampled 1/3 of the time. The first time element (0 0 0) is sampled a fatal error will occur because the sampled position, no matter what it is, will be rejected because element (0 0 0) does not exist. CAUTION: Implement automatic lattice sampling carefully and ensure that all of the lattice elements specified on the expanded FILL card really do exist.

See Chapter 4 for an example of specifying a source in a lattice geometry.

Example: SDEF (no entries)

This card specifies a 14-MeV isotropic point source at position 0,0,0 at time 0 with weight 1 (all defaults).

2. SIn Source Information Card
3. SPn Source Probabiy Card
4. SBn Source Bias Card

Form: SIn option  $I_1 \dots I_k$

$n$  = distribution number ( $n = 1,999$ )  
option = how the  $I_i$ 's are to be interpreted. Allowed values are:  
omitted or H—bin boundaries for a histogram distribution,  
for scalar variables only. This is the default.  
L—discrete source variable values  
A—points where a probability density distribution is defined  
S—distribution numbers

$I_1 \dots I_k$  = source variable values or distribution numbers

Default: SIn H  $I_i \dots I_k$

## CHAPTER 3 DATA CARDS

Form: SPn option  $P_1 \dots P_k$   
 or: SPn  $f a b$

$n$  = distribution number ( $n = 1,999$ )  
 option = how the  $P_i$  are to be interpreted. Allowed values are:  
 omitted—same as D for an H or L distribution. Probability density for an A distribution on SI card.  
 D—bin probabilities for an H or L distribution on SI card. This is the default.  
 C—cumulative bin probabilities for an H or L distribution on SI card.  
 V—for cell distributions only. Probability is proportional to cell volume (times  $P_i$  if the  $P_i$  are present).  
 $P_1 \dots P_k$  = source variable probabilities  
 $f$  = designator (negative number) for a built-in function  
 $a, b$  = parameters for the built-in function (see Table 3.4)

Default: SPn D  $P_1 \dots P_k$

Form: SBn option  $B_1 \dots B_k$   
 or: SBn  $f a b$

$n$ , option,  $f$ ,  $a$ , and  $b$  are the same as for the SPn card, except that the only values allowed for  $f$  are  $-21$  and  $-31$   
 $B_1 \dots B_k$  = source variable biased probabilities

Default: SBn D  $B_1 \dots B_k$

The first form of the SP card, where the first entry is positive or nonnumeric, indicates that it and its SI card define a probability distribution function. The entries on the SI card are either values of the source variable or, when the S option is used, distribution numbers. The entries on the SP card are probabilities that correspond to the entries on the SI card.

When the H option is used, the numerical entries on the SI card are bin boundaries and must be monotonically increasing. The first numerical entry on the SP card must be zero and the following entries are bin probabilities or cumulative bin probabilities, depending on whether the D or C option is used. The probabilities need not be normalized. The variable is sampled by first sampling a bin according to the bin probabilities and then sampling uniformly within the chosen bin.

When the A option is used, the entries on the SI card are values of the source variable at which the probability density is defined. The entries must be monotonically increasing, and the lowest and highest values define the range of the variable. The numerical entries on the SP card are values of the probability density corresponding to the values of the variable on the SI card. They need not be normalized. In the sampling process, the probability density is linearly interpolated between the

specified values. The first and last entries on the SP card will typically be zero, but nonzero values are also allowed.

When the L option is used, the numerical entries on the SI card are discrete values of the source variable, such as cell numbers or the energies of photon spectrum lines. The entries on the SP card are either probabilities of those discrete values or cumulative probabilities, depending on whether the D or C option is used. The entries on the SI card need not be monotonically increasing.

The S option allows sampling among distributions, one of which is chosen for further sampling. This feature makes it unnecessary to fold distributions together and is essential if some of the distributions are discrete and others are linearly interpolated. The distributions listed on an SI card with the S option can themselves also have the S option. MCNP can handle this structure to a depth of about 20, which should be far more than necessary for any practical problem. Each distribution number on the SI card can be prefixed with a D, or the D can be omitted. If a distribution number is zero, the default value for the variable is used. A distribution can appear in more than one place with an S option, but a distribution cannot be used for more than one source variable.

The V option on the SP card is a special case used only when the source variable is CEL. This option is useful when the cell volume is a factor in the probability of particle emission. If MCNP cannot calculate the volume of such a cell and the volume is not given on a VOL card, you have a fatal error.

The SB card is used to provide a probability distribution for sampling that is different from the true probability distribution on the SP card. Its purpose is to bias the sampling of its source variable to improve the convergence rate of the problem. The weight of each source particle is adjusted to compensate for the bias. All rules that apply to the first form of the SP card apply to the SB card.

The second form of the SP card, where the first entry is negative, indicates that a built-in analytic function is to be used to generate a continuous probability density function for the source variable. Built-in functions can be used only for scalar variables. See Table 3.3 for a description of these functions.

**CHAPTER 3  
DATA CARDS**

**TABLE 3.4: Built-In Functions for Source Probability and Bias Specification**

Source Variable	Function No. and Input Parameters	Description
ERG	-2 $a$	Maxwell fission spectrum
ERG	-3 $a b$	Watt fission spectrum
ERG	-4 $a b$	Gaussian fusion spectrum
ERG	-5 $a$	Evaporation spectrum
ERG	-6 $a b$	Muir velocity Gaussian fusion spectrum
ERG	-7 $a b$	Spare
DIR, RAD, or EXT	-21 $a$	Power law $p(x) = c x ^a$
DIR or EXT	-31 $a$	Exponential: $p(\mu) = ce^{a\mu}$
TME	-41 $a b$	Gaussian distribution of time

$f = -2$  Maxwell fission energy spectrum:  $p(E) = C E^{1/2} \exp(-E/a)$ , where  $a$  is a temperature in MeV.

Default:  $a = 1.2895$  MeV

$f = -3$  Watt fission energy spectrum:  $p(E) = C \exp(-E/a) \sinh(bE)^{1/2}$ .

Defaults:  $a = 0.965$  MeV,  $b = 2.29$  MeV<sup>-1</sup>. See Appendix H for additional parameters appropriate to neutron-induced fission in various materials and for spontaneous fission.

$f = -4$  Gaussian fusion energy spectrum:  $p(E) = C \exp[-((E-b)/a)^2]$ , where  $a$  is the width in MeV and  $b$  is the average energy in MeV. Width here is defined as the  $\Delta E$  above  $b$  where the value of the exponential is equal to  $e^{-1}$ . If  $a < 0$ , it is interpreted as a temperature in MeV and  $b$  must also be negative. If  $b = -1$ , the D-T fusion energy is calculated and used for  $b$ . If  $b = -2$ , the D-D fusion energy is calculated and used for  $b$ . Note that  $a$  is not the “full-width-at-half-maximum,” but is related to it by  $\text{FWHM} = a (\ln 2)^{1/2}$ .

Defaults:  $a = -0.01$  MeV,  $b = -1$  (DT fusion at 10 keV).

$f = -5$  Evaporation energy spectrum:  $p(E) = C E \exp(-E/a)$ .

Default:  $a = 1.2895$  MeV.

$f = -6$  Muir velocity Gaussian fusion energy spectrum:  $p(E) = C \exp - ((E^{1/2} - b^{1/2})/a)^2$ , where  $a$  is the width in MeV<sup>1/2</sup>, and  $b$  is the energy in MeV corresponding to the average speed. Width here is defined as the change in velocity above the average velocity  $b^{1/2}$ , where the value of the exponential is equal to  $e^{-1}$ . To get a spectrum somewhat comparable to  $f = -4$ , the width can be determined by  $a = (b + a_4)^{1/2} - b^{1/2}$ , where  $a_4$  is the width used with the Gaussian fusion energy spectrum. If  $a < 0$ , it is interpreted as a temperature in MeV. If  $b = -1$ , the D-T fusion energy is calculated and used for  $b$ . If  $b = -2$ , the D-D fusion energy is calculated and used for  $b$ .

Defaults:  $a = -0.01$  MeV,  $b = -1$  (DT fusion at 10 keV).

$f = -7$  Spare energy spectrum. The basic framework for another energy spectrum is in place to make it easier for a user to add a spectrum of his own. The subroutines to change are SPROB, SPEC, SMPSRC, and possibly CALCPS.

$f = -21$  Power law:  $p(x) = c|x|^a$ .

The default depends on the variable. For DIR,  $a = 1$ . For RAD,  $a = 2$ , unless AXS is defined or JSU  $\neq 0$ , in which case  $a = 1$ . For EXT,  $a = 0$ .

$f = -31$  Exponential:  $p(\mu) = ce^{a\mu}$ .

Default:  $a = 0$ .

$f = -41$  Gaussian distribution of time:  $p(t) = c \exp[-(1.6651092(t - b)/a)^2]$ , where  $a$  is the width at half maximum in shakes and  $b$  is the mean in shakes.

Defaults:  $a = \text{no default}$ ,  $b = 0$ .

The built-in functions can be used only for the variables shown in Table 3.3. Any of the built-in functions can be used on SP cards, but only  $-21$  and  $-31$  can be used on SB cards. If a function is used on an SB card, only that same function can be used on the corresponding SP card. The combination of a regular table on the SI and SP cards with a function on the SB card is not allowed.

A built-in function on an SP card can be biased or truncated or both by a table on SI and SB cards. The biasing affects only the probabilities of the bins, not the shape of the function within each bin. If it is biased, the function is approximated within each bin by  $n$  equally probable groups such that the product of  $n$  and the number of bins is as large as possible but not over 300. Unless the function is  $-21$  or  $-31$ , the weight of the source particle is adjusted to compensate for truncation of the function by the entries on the SI card.

Special defaults are available for distributions that use built-in functions.

1. If SB  $f$  is present and SP  $f$  is not, an SP  $f$  with default input parameters is, in effect, provided by MCNP.
2. If only an SI card is present for RAD or EXT, an SP  $-21$  with default input parameters is, in effect, provided.
3. If only SP  $-21$  or SP  $-31$  is present for DIR or EXT, an SI 0 1, for  $-21$ , or SI  $-1$  1, for  $-31$ , is, in effect, provided.
4. If SI  $x$  and SP  $-21$  are present for RAD, the SI is treated as if it were SI 0  $x$ .
5. If SI  $x$  and SP  $-21$  or SP  $-31$  are present for EXT, the SI is treated as if it were SI  $-x$   $x$ .



## CHAPTER 3 DATA CARDS

### 5. DSn Dependent Source Distribution Card

Form:       DSn   option  $J_1 \dots J_k$   
or:         DSn   T        $I_1 J_1 \dots I_k J_k$   
or:         DSn   Q        $V_1 S_1 \dots V_k S_k$

$n$  = distribution number ( $n = 1,999$ )

option = how the  $J_i$  are to be interpreted. Allowed values are:

blank or H—source variable values in a continuous distribution, for scalar variables only

L—discrete source variable values

S—distribution numbers

T = values of the dependent variable follow values of the independent variable, which must be a discrete scalar variable

$I_i$  = values of the independent variable

$J_i$  = values of the dependent variable

Q = distribution numbers follow values of the independent variable, which must be a scalar variable

$V_i$  = monotonically increasing set of values of the independent variable

$S_i$  = distribution numbers for the dependent variable

Default:   DSn    H     $J_1 \dots J_k$

The DS card is used instead of the SI card for a variable that depends on another source variable, as indicated on the SDEF card. No SP or SB card is used. MCNP first determines the value of the independent variable as usual by sampling the probability function of the independent variable. Then the value of the dependent variable is determined according to the form of the DS card.

The first form of the DS card has several possibilities. If the SI card of the independent variable has a histogram distribution of  $n$  bins ( $n + 1$  entries) and the DS card has the blank or H option, the DS card must have  $n + 1$  entries to specify  $n$  bins. The first entry need not be zero. If the sampled value of the independent variable is  $I_i + [f(I_{i+1} - I_i)]$ , then the value of the dependent variable is  $J_i + [f(J_{i+1} - J_i)]$ , where the terms in  $f$  are used only for continuous distributions. The interpolation factor  $f$  always exists whether or not it is needed for the independent distribution.

If the L or S option is used on the DS card,  $n$  entries are required to specify  $n$  discrete values. It is not necessary for the distributions of the independent and dependent variables to be both discrete or both continuous. All combinations work correctly.

When the T option is used on a DS card, the sampled value of the independent variable is sought among the  $I_i$ , and if a match is found, the independent variable gets the value  $J_i$ . If no match is found, the dependent variable gets its default value. The purpose of the T option is to shorten the input when a dependent variable should usually get the default value.

When the Q option is used on a DS card, the  $V_i$  define a set of bins for the independent variable. The sampled value of the independent variable is compared with the  $V_i$ , starting with  $V_1$ , and if the sampled value is less than or equal to  $V_i$ , the distribution  $S_i$  is sampled for the value of the dependent variable. The value of  $V_k$  must be greater than or equal to any possible value of the independent variable. If a distribution number  $S_i$  is zero, the default value for the variable is used. The Q option is the only form of the DS card that can be used when the distribution of the independent variable is a built-in function.

#### 6. SCn Source Comment Card

Form: SCn comment

n = distribution number ( $n=1,999$ )

The comment is printed as part of the header of distribution  $n$  in the source distribution table and in the source distribution frequency table. The & continuation symbol is considered as part of the comment, not as a continuation command.

Default: No comment.

#### Examples of the General Source

Example 1: SDEF ERG=D1 POS= $x y z$  WGT= $w$   
 SI1 H  $E_1$   $E_2 \dots E_k$   
 SP1 D 0  $P_2 \dots P_k$   
 SB1 D 0  $B_2 \dots B_k$

This is a point isotropic source at  $x,y,z$  with a biased continuous-energy distribution and average source particle weight  $w$ . The starting cell is not specified. MCNP will determine it from the values of  $x$ ,  $y$ , and  $z$ .

Example 2: SDEF SUR= $m$  AXS= $i j k$  EXT=D6  
 SB6 -31 1.5

This is a source on surface  $m$ . The presence of AXS and EXT implies that surface  $m$  is a sphere because AXS and EXT are not otherwise used together for sources on a surface. By default, the particles are emitted in a cosine distribution. They are emitted outward if the positive normal to the sphere is outward, which it is for all the spherical surface types but might not be if the sphere is specified as type SQ. The position on the surface is biased toward the direction  $i,j,k$  by an exponential bias (specified by -31) such that the maximum and minimum source particle weights are  $e^{1.5} = 4.48$  and  $e^{-1.5} = 0.223$ . By default, MCNP provides the effect of two cards: SI6 -1 1 and SP6 -31 0.

**CHAPTER 3**  
**DATA CARDS**

Example 3: SDEF SUR= $m$  NRM=-1 DIR=D1 WGT= $w$   
 SB1 -21 2

This is an inward-directed source on spherical surface  $m$ , assuming the positive normal of the surface is directed outward. If  $w = \pi r^2$ , where  $r$  is the radius of sphere  $m$ , this source in conjunction with a VOID card, a VOL card, and type 2 and type 4 tallies, is suitable for estimating the areas of surfaces and the volumes of cells. See page 2-183. By default, MCNP provides the effect of two cards: SI1 0 1 and SP1 -21 1. The directional bias by the SB1 card causes higher track density toward the center of the sphere, where presumably the cells of greatest interest lie, than it would be if the unbiased cosine distribution were used. This bias, incidentally, provides a zero-variance estimate of the (known) volume of the sphere  $m$ .

Example 4: SDEF ERG=D1 POS= $x y z$  CEL= $m$  RAD=D2  
 EXT=D3 AXS= $i j k$   
 SP1 -3  
 SI2  $r_1 r_2$   
 SI3  $l$

This source is distributed uniformly in volume throughout cell  $m$ , which presumably approximates a cylinder. The cell is enclosed by a sampling volume centered at  $x,y,z$ . The axis of the sampling volume is the line through  $x,y,z$  in the direction  $i,j,k$ . The inner and outer radii of the sampling volume are  $r_1$  and  $r_2$ , and it extends along  $i,j,k$  for a distance  $\pm l$  from  $x,y,z$ . The user has to make sure that the sampling volume totally encloses cell  $m$ . The energies of the source particles are sampled from the Watt fission spectrum using the default values of the two parameters, making it a Cranberg spectrum. By default, MCNP interprets SI3  $l$  as if it were actually SI3  $-l + l$  and provides the effect of two cards: SP2 -21 1 and SP3 -21 0.

Example 5: SDEF SUR= $m$  POS= $x y z$  RAD=D1 DIR=1 CCC= $n$   
 SI1  $r$

This is a monodirectional source emitted from surface  $m$  in the direction of the positive normal to the surface. The presence of POS and RAD implies that surface  $m$  is a plane because POS and RAD are not otherwise used together for sources on a surface. The position is sampled uniformly in area on the surface within radius  $r$  of point  $x,y,z$ . The user must make sure that point  $x,y,z$  actually lies on surface  $m$ . The sampled position is rejected and resampled if it is not within cookie-cutter cell  $n$ . The starting cell is found from the position and the direction of the particle. By default, MCNP interprets SI1  $r$  as if it were actually SI1 0  $r$  and provides the effect of card SP1 -21 1.

Example 6: SDEF POS D1 ERG FPOS D2  
 SI1 L 5 3.3 6 75 3.3 6  
 SP1 .3 .7  
 DS2 S 3 4

SI3      H 2 10 14  
SP3      D 0 1 2  
SI4      -3 a b

This is a point isotropic source in two locations, shown by two  $x,y,z$ 's on the SI1 card. The code will determine the starting cell. With probability .3 the first location will be picked and with probability .7 the second location will be chosen. Each location has a different energy spectrum, pointed to by the DS2 card. All other needed source variables will use their default values.

7. SSW Surface Source Write Card

Form:      SSW     $S_1$      $S_2 (C_1 \cdot \cdot \cdot C_k)$      $S_3$      $S_n$     keyword=values

The = signs are optional.

$S_i$  = problem surface number, with the appropriate sense of inward or outward particle direction, for which particle-crossing information is to be written to the surface source file WSSA. Macrobody surfaces are not allowed.

$C_i$  = problem cell number. A positive entry denotes an other-side cell. A negative entry specifies a just-left cell.

SYM    m    symmetry option flag

m=0, no symmetry assumed.

m=1, spherical symmetry assumed. The list of problem surface numbers must contain only one surface and it must be a sphere.

m=2, write particles to a surface bidirectionally. Otherwise, only particles going out of a positive surface and into a negative surface are recorded.

PTY     $n_1 n_2 \cdot \cdot \cdot$     tracks to record

absent=record all tracks. This is the default.

$n_i=N$ , record neutron tracks

$n_i=P$ , record photon tracks

$n_i=E$ , record electron tracks

CEL     $C_1 C_2 \cdot \cdot \cdot C_n$

list of names of all the cells from which KCODE fission source neutrons are to be written, active cycles only.

Default:    SYM=0    PTY absent=record all particle types

Use:      Optional, as needed.

This card is used to write a surface source file or KCODE fission volume source file for use in a subsequent MCNP calculation. Care must be taken to include enough geometry beyond the specified surfaces to account for albedo effects. The card allows a list, in parentheses, of one or more cell names, positive or negative, after any of the surface names. If the list of cells is absent, any track that crosses the surface in the correct direction will be recorded. If the list is present, a

## CHAPTER 3 DATA CARDS

track will be recorded if it crosses the surface in the correct direction and is either entering a cell in the list whose entry is positive or leaving a cell in the list whose entry is negative.

If the SYM=1 option is used, the geometry inside the surface must be spherically symmetric and the materials must be symmetric. In very few cases will the SYM=1 option apply. The user must determine whether SYM=1 is appropriate for the problem. If the SYM=1 option is used, fewer words per particle need to be written to the surface source file and certain biasing options become available when reading the surface source file. In a KCODE calculation, particles are written only for active cycles.

Example: SSW 4 -7 19 (45 -46) 16 -83 (49) . . .

A track that crosses surface 19 in the correct direction will be recorded only if it is either entering cell 45 or leaving cell 46. A track that crosses surface 83 in the correct direction will be recorded only if it is entering cell 49. A track that crosses surface 4 or 7 or 16 in the correct direction will be recorded regardless of what cells it happens to be leaving or entering.

Fission volume sources from a KCODE calculation can be written from active cycles only. The fission neutrons and prompt photons can then be transported in a subsequent calculation using the SSR surface source read fixed-source capability. In a KCODE criticality calculation the fission neutron sources and prompt photons produced from fission during each cycle are written to the WSSA surface source file if the SSW card has the CEL keyword followed by the names of all the cells from which fission source neutrons are to be written. Particles crossing specified surfaces can also be written by specifying  $S_j$ . The SYM=1 option (spherically symmetric surface source) cannot be used if CEL is specified.

Example: SSW 1 2 (3 4) CEL 8 9

A track that crosses surface 2 in the correct direction will be recorded only if it enters cell 3 or 4. A track crossing surface 1 in the correct direction always will be recorded. And particles created from fission events in cells 8 and 9 will be recorded.

During execution, surface source information is written to the scratch file WXXA. Upon normal completion, WXXA becomes WSSA. If the run terminates abnormally, the WXXA file will appear instead of WSSA and must be saved along with the RUNTPE file. The job must be continued for at least one more history. At the subsequent normal termination, WXXA disappears and the correct surface source file WSSA is properly written.

### 8. SSR Surface Source Read Card

Form: SSR keyword=values keyword=values  
The = signs are optional.

OLD	$S_1 S_2 \dots S_n$ list of problem surface numbers, a subset of the surfaces on the SSW card that created the file WSSA, now called RSSA. Macrobody surfaces are not allowed.
CEL	$C_1 C_2 \dots C_n$ like OLD but for cells in which KCODE fission neutrons or photons were written
NEW	$S_{a1} S_{a2} \dots S_{an} S_{b1} S_{b2} \dots S_{bn}$ problem surface numbers upon which the surface source is to start particles in this run. The $n$ entries may be repeated to start the surface source in $a, b, \dots$ transformed locations.
COL	$m$ collision option flag $m = -1$ start from the surface source file only those particles that came directly from the source without a collision $m = 1$ start from the surface source file only those particles that had collisions before crossing the recording surface $m = 0$ start particles without regard to collisions
WGT	$x$ Each particle weight is multiplied by the constant $x$ as it is accepted for transport.
TR	$n$ transformation number. Track positions and velocities are transformed from the auxiliary coordinate system (the coordinate system of the problem that wrote the surface source file) into the coordinate system of the current problem, using the transformation on the TR $n$ card, which must be present in the INP file of the current problem.
TR	$D_n$ Distribution number for a set of SIn, SPn, and SBn cards. If the surface source is transformed into several locations, the SIn card lists the transformation numbers and the SPn and SBn cards give the probabilities and bias of each transformation.
PSC	$c$ a nonnegative constant that is used in an approximation to the PSC evaluation for the probability of the surface source emitting a particle into a specified angle relative to the surface normal.

The following four keywords are used only with spherically symmetric surface sources, that is, sources generated with SYM=1 on the SSW card.

AXS	$u \ v \ w$ Direction cosines that define an axis through the center of the surface sphere in the auxiliary (original) coordinate system. This is the reference vector for EXT.
EXT	$D_n$ $n$ is the number of a distribution (SIn, SPn, and SBn cards) that will bias the sampling of the cosine of the angle between the direction AXS and the vector from the center of the sphere to the starting point on the sphere surface.
POA	$c$ Particles with a polar angle cosine relative to the source surface normal that falls between 1 and $c$ will be accepted for transport. All others are disregarded

## CHAPTER 3 DATA CARDS

and no weight adjustment is made.

BCW  $r z_b z_e$   $0 < z_b < z_e$  All particles with acceptable polar angles relative to the surface normal are started so that they will pass through a cylindrical window of radius  $r$ , starting at  $z_b$  from the center of the source sphere, and ending at  $z_e$  from the center. The axis of the cylinder is parallel to the z-axis of the auxiliary (original) coordinate system and contains the center of the source sphere. The weight of each source particle is adjusted to compensate for this biasing of position and direction.

Defaults: OLD accept all surfaces in the original run.  
CEL accept all cells in the original run.  
NEW the surfaces in the OLD list.  
COL  $m = 0$   
WGT 1  
TR no transformation  
AXS no axis  
EXT no position bias  
POA  $c = 0$   
BCW no cylindrical window  
PSC no default value

Use: Required for surface source problems.

The particle type is determined primarily by the type of the particle on the RSSA file, but particles incompatible with the problem mode are rejected without weight adjustment.

An exact treatment of point detectors or DXTRAN spheres with a surface source is not possible because the  $p(\cos\theta)$  values required for the source contribution are not readily available. (See the description of detector tallies in Chapter 2.) To use detectors or DXTRAN with a surface source, an approximate  $p(\cos\theta)$  must be specified on the SSR card. The most common azimuthally symmetric approximation for an angular emission probability density function is given by

$$p(\cos\theta) = C_n (\cos\theta)^n \quad n \geq 0$$

The PSC=value entered is  $n$ , the power to which  $p(\cos\theta)$  is raised.  $C_n$  is a normalization constant calculated in MCNP and  $\theta$  is the angle between the direction vector to the point detector and the surface normal at the point where the particle is to be started. Because surface crossings are recorded in only one direction specified on the SSW card, the limits on  $\mu$  are always between 1 and 0. A PSC entry of zero specifies an isotropic angular distribution on the surface. An entry of 1 specifies a cosine angular distribution that produces an isotropic angular flux on the surface. In the case of a 1D spherical surface source of radius  $R$ , a cosine distribution is adequate if the point detector or DXTRAN sphere is more than  $4R$  away from the source.

**WARNING:** Remember that the value entered is only an approximation. If the point detector or DXTRAN sphere is close to the source sphere and the approximation is poor, the answers will be **WRONG**.

Fission neutrons and photons written to the surface source file in a KCODE calculation can be used as a volume–distributed source in a subsequent calculation. A NONU card should be used so that fission neutrons and photons are not counted twice. Generally a TOTNU card also should be used. Total  $\bar{\nu}$  is the default for KCODE sources but prompt  $\bar{\nu}$  is the default for non–KCODE sources. Delayed gammas are ignored in MCNP. The keyword CEL specifies which fission cells to accept of those from the KCODE calculation that wrote the RSSA file.

```

Example 1:  Original run:  SSW  1  2  3
              Current run:  SSR  OLD 3  2 NEW 6  7  12 13 TR D5 COL 1
                      SI5   L  4  5
                      SP5   .4 .6
                      SB5   .3 .7
  
```

Particles starting on surface 1 in the original run will not be started in the current run because 1 is absent from the list of OLD surface numbers. Particles recorded on surface 2 in the original run will be started on surfaces 7 and 13 and particles recorded on surface 3 in the original run will be started on surfaces 6 and 12, as prescribed by the mapping from the OLD to the NEW surface numbers. The COL keyword causes only particles that crossed surfaces 2 and 3 in the original problem after having undergone collisions to be started in the current problem. The TR entry indicates that distribution function 5 describes the required surface transformations. According to the SI5 card, surfaces 6 and 7 are related to surfaces 3 and 2, respectively, by transformation TR4; surfaces 12 and 13 are related to 3 and 2 by TR5. The physical probability of starting on surfaces 6 and 7 is 40% according to the SP5 card, and the physical probability of starting on surfaces 12 and 13 is 60%. The SB5 card causes the particles from surfaces 3 and 2 to be started on surfaces 6 and 7 30% of the time with weight multiplier 4/3 and to be started on surfaces 12 and 13 70% of the time with weight multiplier 6/7.

```

Example 2:  Original run:  SSW  3  SYM 1
              Current run:  SSR  AXS 0  0  1  EXT D99
                      SI99   -1 .5  1
                      SP99   C .75  1
                      SB99   .5 .5
  
```

All particles written to surface 3 in the original problem will be started on surface 3 in the new problem, which must be exactly the same because no OLD, NEW, COL, or TR keywords are present. Because this is a spherically symmetric problem, indicated by the SYM 1 flag in the original run, the position on the sphere can be biased. It is biased in the  $z$ -direction with a cone bias described by distribution 99.



## CHAPTER 3 DATA CARDS

### 9. KCODE Criticality Source Card

Form:    KCODE    NSRCK RKK IKZ KCT MSRK KNRM MRKP KC8 ALPHA

NSRCK = number of source histories per cycle  
RKK    = initial guess for  $k_{eff}$   
IKZ    = number of cycles to be skipped before beginning tally accumulation  
KCT    = number of cycles to be done  
MSRK   = number of source points to allocate storage for  
KNRM   = normalize tallies by 0=weight / 1=histories  
MRKP   = maximum number of cycle values on MCTAL or RUNTPE  
KC8    = summary and tally information averaged over:  
          0 = all cycles  
          1 = active cycles only.  
ALPHA = imposed value of alpha.

Defaults:    NSRCK=1000; RKK=1.0; IKZ=30; KCT=IKZ+100; MSRK=4500 or 2\*  
              NSRCK; KNRM=0; MRKP=6500; KC8=1; ALPHA=none.

Use:        This card is required for criticality calculations.

The KCODE card specifies the MCNP criticality source that is used for determining  $k_{eff}$ . The criticality source uses total fission nubar values unless overridden by a TOTNU NO card and applies only to neutron problems. In a MODE N,P problem, secondary photon production from neutrons is turned off during inactive cycles. SSW particles are not written during inactive cycles. If alpha is positive, use default implicit capture. See Chapter 1 for further information.

The NSRCK entry is the nominal source size for each cycle. The IKZ entry is the number of cycles to skip before beginning tally accumulation (this is important if the initial source guess is poor). The KCT entry specifies the number of cycles to be done before the problem ends. A zero entry means never terminate on the number of cycles but terminate on time. The MSRK is the maximum number of source points for which storage will be allocated. If an SRCTP file with a larger value of MSRK is read for the initial source, the larger value is used.

Fission sites for each cycle are those points generated by the previous cycle. For the initial cycle, fission sites can come from an SRCTP file from a similar geometry, from a KSRC card, or from a volume distribution specified by an SDEF card.

If in the first cycle the source being generated overruns the current source, the initial guess (RKK) is probably too low. The code then proceeds to print a comment, continues without writing a new source, calculates  $k'_{eff}$ , reads the initial source back in, and begins the problem using  $k'_{eff}$  instead of RKK. If the generated source again overruns the current source after the first cycle, the job terminates and either a better initial guess (RKK) or more source space (MSRK) should be specified on the next try.

KC8=0 causes tallies and summary table information to be for both active and inactive cycles and should not be used. KC8=0 also results in a strange MCTAL file normalization.

**10. KSRC Source Points for KCODE Calculation**

Form:    KSRC     $x_1 y_1 z_1 x_2 y_2 z_2 \dots$

$x_i, y_i, z_i$  = location of initial source points

Default: None. If this card is absent, an SRCTP source file or SDEF card must be supplied to provide initial source points for a criticality calculation.

Use:       Optional card for use with criticality calculations.

This card contains up to NSRCK (x,y,z) triplets that are locations of initial source points for a KCODE calculation. At least one point must be in a cell containing fissile material and points must be away from cell boundaries. It is not necessary to input all NSRCK coordinate points. MCNP will start approximately (NSRCK/number of points) particles at each point. Usually one point in each fissile region is adequate, because MCNP will quickly calculate and use the new fission source distribution. The energy of each particle in the initial source is sampled from a Watt fission spectrum hardwired into MCNP, with  $a = 0.965$  MeV and  $b = 2.29$  MeV<sup>-1</sup>.

An SRCTP file from a previous criticality calculation can be used instead of a KSRC card. If the current problem has a lot in common with the previous problem, using the SRCTP file may save some computer time. Even if the problems are quite different, the SRCTP file may still be usable if some of the points in the SRCTP file are in cells containing fissile material in the current problem. Points in void or zero importance cells will be deleted. The number of particles actually started at each point will be such as to produce approximately NSRCK initial source particles.

An SDEF card also can be used to sample initial source points in fissile material regions. The SDEF card parameters applicable to volume sampling can be used: CEL, POS, RAD, EXT, AXS, X, Y, Z; and CCC, ERG, and EFF. If a uniform volume distribution is chosen, the early values of  $k_{eff}$  will likely be low because too many particles are put near where they can escape, just the opposite of the usual situation with the KSRC card. Do not change the default value of WGT for a KCODE calculation.

**11. ACODE Alpha Eigenvalue Source Card**

Form:    ACODE    NSRCK RKK IKZ KCT MSRK KNRM KALPHA KALSAV  
                  KALREG MRKP ALMIN

NSRCK = number of source histories per cycle

RKK    = initial guess for  $k_{eff}$

IKZ     = number of cycles to be skipped before beginning tally accumulation

## CHAPTER 3 DATA CARDS

KCT = number of cycles to be done  
MSRK = number of source points to allocate storage for  
KNRM = normalize tallies by 0=weight / 1=histories  
KALPHA = alpha estimator: 1/2/3 = col/abs/trk  
4 = differential operator perturbation estimator  
KALSAV = cycle to start averaging alphas  
KALREG = cycle to start ln-ln regression and reduce number of internal  
settle cycles  
MRKP = maximum number of cycle values on MCTAL or RUNTPE  
ALPHA = initial guess of alpha  
ALMIN = minimum floor value of alpha.

Defaults: NSRCK=1000; RKK=1.0; IKZ=30; KCT=IKZ+100; MSRK=4500 or 2\*  
NSRCK; KNRM=0; KALPHA=1; KALSAV=automatic;  
KALREG=KALSAV+2; MRKP=6500; ALPHA=0; ALMIN=0

The alpha eigenvalue is  $N = N_0 e^{\alpha t}$ , where  $N$  is the neutron population at some time  $t$  that builds up from some initial population  $N_0$ . Alpha is of interest for comparison to benchmark calculations and comparison to deterministic transport codes such as DANTSYS. The alpha capability allows positive and negative alpha searches and a fixed positive or negative alpha value to be used in a  $k_{eff}$  eigenvalue calculation. Negative values of alpha can result in a time creation (n,2n) delta scattering reaction. Positive alpha is treated as time absorption. We recommend the use of default implicit capture for positive alpha problems.

### 12. Subroutines SOURCE and SRCDX

If SDEF, SSR, or KCODE cards are not present in the INP file, a user supplied source is assumed and is implemented by calling subroutine SOURCE, which the user must provide. Chapter 4 has examples of a SOURCE subroutine and discusses the SRCDX subroutine. The parameters that must be specified within the subroutine are listed and defined on page 3–49. Prior to calling subroutine SOURCE, isotropic direction cosines  $u, v, w$  (UUU,VVV,WWW) are calculated and need not be specified if you want an isotropic distribution.

The SIn, SPn, and SBn cards also can be used with the SOURCE subroutine, although modifications to other parts of MCNP may be required for proper initialization and to set up storage. A random number generator RANG( ) is available for use by SOURCE for generating random numbers between 0 and 1. Up to 50 numerical entries can be entered on each of the IDUM and RDUM cards for use by SOURCE. The IDUM entries must be integers and the RDUM entries floating point numbers.

If you are using a detector or DXTRAN and your source has an anisotropic angular distribution, you will need to supply an SRCDX subroutine to specify PSCs for each detector or DXTRAN sphere (see Chapters 2 and 4).

There are unused variables stored in the particle bank that are reserved for the user called SPARE(M), M=1,MSPARE, where MSPARE=3. Depending on the application, you may need to reset them to 0 in SOURCE for each history; MCNP does not reset them.

***E. Tally Specification***

The tally cards are used to specify what type of information the user wants to gain from the Monte Carlo calculation; that is, current across a surface, flux at a point, heating in a region, etc. This information is requested by the user by using a combination of the following cards. To obtain tally results, only the Fn card is required; the other tally cards provide various optional features.

<u>Mnemonic</u>	<u>Card Type</u>	<u>Page</u>
Fna	Tally type	3-74
FCn	Tally comment	3-83
En	Tally energies	3-83
Tn	Tally times	3-84
Cn	Tally cosines	3-85
FQn	Tally print hierarchy	3-86
FMn	Tally multiplier	3-87
DEn/DFn	Dose energy/Dose function	3-91
EMn	Energy multiplier	3-92
TMn	Time multiplier	3-93
CMn	Cosine multiplier	3-93
CFn	Cell flagging	3-94
SFn	Surface flagging	3-95
FSn	Tally segment	3-95
SDn	Segmented volume/area	3-97
FUn	TALLYX input	3-98
TFn	Tally fluctuation print	3-100
DD	Detector and DXTRAN diagnostics	3-102
DXT	DXTRAN	3-103
FTn	Special treatments	3-105

The *n* is a user-chosen tally number < 999; choices of *n* are given in the following section. When a choice of *n* is made for a particular tally type, any other input card used with that tally (such as En for energy bins) is given the same value of *n* by the user.

Much of the information on these cards is used to describe tally “bins,” subdivisions of the tally space into discrete and contiguous increments such as cosine, energy, or time. Usually when the user subdivides a tally into bins, MCNP can also provide the total tally summed over appropriate bins (such as over energy bins). Absence of any bin specification card results in one unbounded bin

## CHAPTER 3 DATA CARDS

rather than one bin with a default bound. No information is printed about the limits on the unbounded bin.

If there are reflecting surfaces or periodic boundaries in the problem, the user may have to normalize the tallies in some special way (this can be done by setting the weight of the source particles or by using the FMn card).

Printed with each tally bin is the relative error of the tally corresponding to one standard deviation. These errors *cannot* be believed reliable (hence neither can the tally itself) unless the error is fairly low. Results with errors greater than 50% are useless, results between 20% and 50% can be believed to within a factor of a few, results between 10% and 20% are questionable, results less than 10% are generally (but not always) reliable except for detectors, and detector results are generally reliable below 5%. One bin of every tally is designated for the tally fluctuation charts at the end of the output file. This bin is also used for the weight window generator. It also is subject to ten statistical checks for tally convergence, including calculation of the variance of the variance (VOV). The VOV can be printed for all bins in a tally by using the DBCN card.

### 1. Fna Tally Cards

Seven basic neutron tally types, six basic photon tally types, and four basic electron tally types are available in MCNP as standard tallies. All are normalized to be per source particle unless changed by the user with a TALLYX subroutine or normed by weight in a criticality (KCODE) calculation.

<u>Mnemonic</u>	<u>Tally Description</u>	<u>Fn units</u>	<u>*Fn units</u>
F1:N or F1:P or F1:E	Current integrated over a surface	particles	MeV
F2:N or F2:P or F2:E	Flux averaged over a surface	particles/cm <sup>2</sup>	MeV/cm <sup>2</sup>
F4:N or F4:P or F4:E	Flux averaged over a cell	particles/cm <sup>2</sup>	MeV/cm <sup>2</sup>
F5a:N or F5a:P	Flux at a point or ring detector	particles/cm <sup>2</sup>	MeV/cm <sup>2</sup>
F6:N or F6:N,P or F6:P	Energy deposition averaged over a cell	MeV/g	jerks/g
F7:N	Fission energy deposition averaged over a cell	MeV/g	jerks/g
F8:P or F8:E or F8:P,E	Energy distribution of pulses created in a detector	pulses	MeV
+F8:E	Charge deposition	charge	N/A

The tallies are identified by tally type and particle type as follows. Tallies are given the numbers 1, 2, 4, 5, 6, 7, 8, or increments of 10 thereof, and are given the particle designator :N, :P, or :E (or

:N,P only in the case of tally type 6 or :P,E only in the case of tally type 8). Thus you may have as many of any basic tally as you need, each with different energy bins or flagging or anything else. F4:N, F14:N, F104:N, and F234:N are all legitimate neutron cell flux tallies; they could all be for the same cell(s) but with different energy or multiplier bins, for example. Similarly F5:P, F15:P, and \*F305:P are all photon point detector tallies. Having both an F1:N card and an F1:P card in the same INP file is not allowed. The tally number may not exceed three digits.

Tally types 1, 2, 4, and 5 are normally weight tallies (particles in the above table); however, if the Fn card is flagged with an asterisk (for example, \*F1:N), energy times weight will be tallied. The asterisk flagging can also be used on tally types 6 and 7 to change the units from MeV/g to jerks/g (1 jerk = 1 GJ = 10<sup>9</sup> J). The asterisk on a tally type 8 converts from a pulse height tally to an energy deposition tally. All of the units are shown in the above table.

Tally type 8 can also be flagged with a plus (+) to convert it from an energy deposition tally (flagged with an asterisk) to a charge deposition tally. The tally is the negative particle weight for electrons and the positive weight for positrons. The +F8 tally can be checked against an F1:E type surface tally. See page 3–79 for an example.

Only the F2 surface flux tally requires the surface area. The area calculated is the total area of the surface that may bound several cells, not a portion of the surface that bounds only a particular cell. If you need only the segment of a surface, you might segment the full surface with the FS<sub>n</sub> card (see page 3–95) and use the SD<sub>n</sub> card (see page 3–97) to enter the appropriate values. You can also redefine the geometry as another solution to the problem. The detector total is restricted to 20. The tally total is limited to 100. Note that a single type 5 tally may create more than one detector.

1. Surface and Cell Tallies (tally types 1, 2, 4, 6, and 7)

Simple Form: Fn:pl  $S_1 \dots S_k$   
 General Form: Fn:pl  $S_1 (S_2 \dots S_3) (S_4 \dots S_5) S_6 S_7 \dots$

- n = tally number.
- pl = N or P or N,P or E
- $S_i$  = problem number of surface or cell for tallying, or  $T$ .

Only surfaces bounding cells and listed in the cell card description can be used on F1 and F2 tallies. Tally 6 does not allow E. Tally 7 allows N only.

In the simple form above, MCNP creates  $k$  surface or cell bins for the requested tally, listing the results separately for each surface or cell. In the more general form, a bin is created for each surface or cell listed separately and for each collection of surfaces or cells enclosed within a set of parentheses. Entries within parentheses also can appear separately or in other combinations. Parentheses indicate that the tally is for the union of the items within the parentheses. For unnormalized tallies (tally type 1), the union of tallies is a sum, but for normalized tallies (types 2,

## CHAPTER 3 DATA CARDS

4, 6, and 7), the union results in an average. See page 3–79 for an explanation of the repeated structure and lattice tally format.

The symbol  $T$  entered on surface or cell Fn cards is shorthand for a region that is the union of all of the other entries on the card. A tally is made for the individual entries on the Fn card plus the union of all the entries.

If a tally label of the surfaces or cells in the output requires more than eleven characters, including spaces, MCNP defines an alphabetical or numerical designator for printing purposes. The designator [for example, G is (1 2 3 4 5 6)] is printed with the tally output. This labeling scheme is usually required for tallies over the union of a long list of surfaces or cells.

Example 1:      F2:N 1 3 6 T

This card specifies four neutron flux tallies, one across each of the surfaces 1, 3, and 6 and one which is the average of the flux across all three of the surfaces.

Example 2:      F1:P (1 2) (3 4 5) 6

This card provides three photon current tallies, one for the sum over surfaces 1 and 2; one for the sum over surfaces 3, 4, and 5; and one for surface 6 alone.

Example 3:      F371:N (1 2 3) (1 4)  $T$

This card provides three neutron current tallies, one for the sum over surfaces 1, 2, and 3; one for the sum over surfaces 1 and 4; and one for the sum over surfaces 1, 2, 3, and 4. The point of this example is that the  $T$  bin is not confused by the repetition of surface 1.

Another case for study is in the DEMO example in Chapter 5.

### 2. Detector Tallies (tally type 5)

Form for point detectors: Fn:pl X Y Z  $\pm R_o$

- $n$  = tally number.
- pl =  $N$  for neutrons or  $P$  for photons,
- X Y Z = location of the detector point.
- $\pm R_o$  = radius of the sphere of exclusion:  
in centimeters, if  $R_o$  is entered as positive,  
in mean free paths, if entered as negative. (Negative entry illegal in a void.)

Form for ring detectors: Fna:pl  $a_o$   $r$   $\pm R_o$

- $n$  = tally number.
- $a$  = the letter X, Y, or Z.
- pl =  $N$  for neutrons or  $P$  for photons.
- $a_o$  = distance along axis “a” where the ring plane intersects the axis.
- $r$  = radius of the ring in centimeters.
- $\pm R_o$  = same meaning as for point detectors, but describes a sphere about the point selected on the ring.

Default: None.

Use: You are encouraged to read about detectors in Chapter 2 before using them because they are very susceptible to unreliable results if used improperly. Remember that contributions to a detector are not made through a region of zero importance. Ring (rather than point) detectors should be used in all problems with axial symmetry. A detector located right on a surface probably will cause trouble. Detectors and DXTRAN can be used in problems with the  $S(\alpha,\beta)$  thermal treatment, but the  $S(\alpha,\beta)$  contributions are approximate (see page 2–53. Detectors used with reflecting, white, or periodic surfaces give wrong answers (see page 2–92). Consider using the PDn and DDn cards.

For more than one detector with the same  $n$  or  $na$  designation, sets of the above input parameters (quadruplets for Fn or triplets for Fna) are simply continued on the same Fn or Fna card. If more than one detector of the same type (an F5:N and an F15:N, for example) are at the same location, the time-consuming contribution calculation upon collision is made only once and not independently for each detector, according to the rules in Chapter 2. Thus it is inexpensive to add more than one detector (each with a different response function, for example) at the same location as another.

The printout for detectors is normally in two parts: (1) the total of all contributions to the detector (as a function of any defined bins such as energy) and (2) the direct (or uncollided) contribution to the detector from the source. The direct contribution is always included in the total of all contributions. Adding the symbol ND at the end of a type 5 detector tally card inhibits the separate printing of the direct contribution for that tally. In coupled neutron/photon problems, the direct contribution in photon tallies is from photons created at neutron collisions.

Rules of Thumb for  $R_o$ :  $R_o$  should be about 1/8 to 1/2 mean free path for particles of average energy at the sphere and zero in a void. Supplying  $R_o$  in terms of mean free path will increase the variance and is not recommended unless you have no idea how to specify it in centimeters.  $R_o$  must not encompass more than one material. MCNP cannot check this and the consequences may be wrong answers.



## CHAPTER 3 DATA CARDS

### 3. Pulse Height Tally (tally type 8)

Simple Form: Fn:pl  $S_1 \dots S_k$   
General Form: Fn:pl  $S_1 (S_2 \dots S_3) (S_4 \dots S_5) S_6 S_7 \dots$

$n$  = tally number.  
pl = P, E or P,E  
 $S_i$  = problem number of cell for tallying, or  $T$ .

The F8 tally provides the energy distribution of pulses created in a detector by radiation and is called a pulse height tally. See page 3–79 for an explanation of the repeated structure and lattice tally format. The F8 card is used to list the cell bins, just like an F4 tally. The union of tallies produces a tally sum, not an average. Cell, user, and energy bin cards are allowed. Flagging, segment, multiplier, time, and cosine bins are not allowed. The energy bins accumulate the energy deposited in a cell by all the tracks of a history rather than the energy of the scoring tracks. Both photons and electrons will be tallied if present, even if only E or only P is on the F8 card. In other words, the F8:P, F8:E, and F8:P,E are all equivalent tallies. An asterisk on the F8 card converts the tally from a pulse height tally to an energy deposition tally. A plus on the F8 card converts the tally from a pulse height tally to a charge deposition tally in units of electron charge. Energy binning is not recommended.

If the F8 card has an asterisk or plus and there is no energy binning (E8 card), variance reduction of all kinds is allowed. In this special case, the total energy deposition or charge is correct even though the tallies in energy bins would not be correct. However, there still can be problems as described on page 2–83.

Care must be taken when selecting energy bins for a pulse height tally. It is recommended that a zero bin and an epsilon bin be included such as

E8 0 1E-5 1E-3 1E-1 ...

The zero bin will catch nonanalog knock-on electron negative scores. The epsilon (1E-5) bin will catch scores from particles that travel through the cell without depositing energy. See page 2–83.

The pulse height tally is a radical departure from other MCNP tallies. All other tallies are estimates of macroscopic variables, such as flux, whose values are determined by very large numbers of microscopic events. The pulse height tally records the energy or charge deposited in a cell by each source particle and its secondary particles. For other tallies it is not necessary to model microscopic events realistically as long as the expectation values of macroscopic variables were correct. For the pulse height tally, microscopic events must be modeled much more realistically.

The departures from microscopic realism in MCNP are everywhere. The number, energies, and directions of the secondary neutrons and photons from a neutron collision are sampled without any

correlation between the particles and with no regard for the conservation of energy. Modeling the fluctuations in the number of fission neutrons is limited to choosing between the integer next larger and the integer next smaller than the average number of fission neutrons. The fluctuations in the energy loss rate of an electron are not correlated with the production of knock-ons and x rays. The variance reduction schemes in MCNP create unrealistic histories that nevertheless give correct results for macroscopic tallies.

Problems that give correct pulse height tallies are severely limited. The only possible variance reduction scheme is biasing of the source itself. **CAUTION:** The pulse height tally does not work well with neutrons (and is not allowed) because of the nonanalog nature of neutron transport that departs from microscopic realism at every turn. One can have a neutron source in a MODE N,P or N,P,E problem, but only the photons and electrons can be tallied on the F8 card. The F8 tally can be used effectively in photon problems. Electron problems may give correct results as long as the tally cells are thick enough for the errors in the energy loss rate to average out. MCNP tries to detect conditions in a problem that would invalidate pulse height tallies, but it is not able to catch all of them. The user must ascertain that his problem does not violate the necessary conditions for obtaining correct answers.

Scoring the pulse height tally is done at the end of each history. A temporary account of energy is kept for each pulse height tally cell bin during the history. At the source, the source cell is credited with the energy times the weight of the source particle. When a particle crosses a surface, the energy times the weight of the particle is subtracted from the account of the cell that it is leaving and is added to the account of the cell that it is entering. The energy here is the kinetic energy of the particle plus 1.022016 MeV if it is a positron. At the end of the history, the account in each tally cell is divided by the source weight. The resulting energy determines which energy bin the score is put in. The value of the score is the source weight, or, if there is an asterisk on the F8 card, the source weight times the energy in the account. If there is a plus on the F8 card, the tally is the negative particle weight for electrons and the positive weight for positrons. The +F8 charge deposition tally can be checked against an electron F1:E surface tally with the FT ELC option if the volume of the +F8 is exactly enclosed by the surfaces on the F1:E card. For example, if cell 1 is enclosed by spherical surface 2, then the following tallies give the same result provided the two F1 current tally bins (in – out) are properly subtracted.

```
+F8:E      and      F1:E 2
                          FT1 ELC 1
                          C1 0 1
```

Note that the meaning of the energy bins of a pulse height tally is entirely different from the meaning of the energy bins of the other tallies in MCNP. The normal meaning of energy bins is the energy of a scoring track. The meaning of the energy bins of a pulse height tally is the energy deposited in a cell bin by all the tracks of a history.



entered as a tally cell (e.g.,  $S_1$  through  $S_5$ ), only cells filled with a universe can be used in higher levels (e.g.,  $C_1$  through  $C_5$ .) See General Form, page 3–79.

*Multiple bin format:* In addition to multiple levels, multiple entries can be used in each level of the tally chain resulting in multiple output bins. Within the parentheses required around the tally bin chain, other sets of parentheses can be used to indicate the union of cells as in a simple tally description, resulting in fewer output tally bins.

$$((S_4 S_5) < (C_1 C_2 [I_1 \dots I_2]) < (C_3 C_4 C_5))$$

This example results in one output tally bin and will be the union of the tally in  $S_4$  plus  $S_5$  that fill  $C_1$  or  $C_2$  [elements  $I_1 \dots I_2$ ] and when  $C_1$  or  $C_2$  fills cells  $C_3, C_4,$  or  $C_5$ . Removing the first and third inner parentheses:

$$(S_4 S_5 < (C_1 C_2 [I_1 \dots I_2]) < C_3 C_4 C_5)$$

results in the creation of  $2*1*3=6$  bins as follows:

$$\begin{aligned} (S_4 < (C_1 C_2 [I_1 \dots I_2]) < C_3), & \quad (S_5 < (C_1 C_2 [I_1 \dots I_2]) < C_3), \\ (S_4 < (C_1 C_2 [I_1 \dots I_2]) < C_4), & \quad (S_5 < (C_1 C_2 [I_1 \dots I_2]) < C_4), \\ (S_4 < (C_1 C_2 [I_1 \dots I_2]) < C_5), & \quad (S_5 < (C_1 C_2 [I_1 \dots I_2]) < C_5), \end{aligned}$$

The repeated structure/lattice input tally bin format with levels that have multiple entries automatically creates multiple output tally bins. The total number of bins generated is the product of the number of entries at each level. If parentheses enclose all entries at a level, the number of entries at that level is one and results in the union of all those entries. See Chapter 4, page 4–46, for a caution when tallying a union of overlapping regions. For unnormalized tallies (type 1, 8), the union is a sum. For normalized tallies (type 2, 4, 6, 7), the union is an average. A symbol  $T$  on the tally line creates an additional tally bin that is the union or total of all the other tally bins.

*Brackets:* Brackets [ ] enclose index data for lattice cell elements. Brackets make it possible to tally on a cell or surface only when it is within the specified lattice elements. The brackets must immediately follow a filled lattice cell. Listing a lattice cell without brackets will produce a tally when the tally cell or surface is in any element of the lattice, provided the tally cell or surface fills an entry at all other levels in the chain. The use of brackets is limited to levels after the first  $<$  in the tally specification.

To tally within lattice elements of a real world (level zero) lattice cell, use the special syntax that follows. Cell 3 contains material 1 and is bounded by four surfaces. The F4 card specifies a tally only in lattice element (0,0,0). This syntax is required because brackets can only follow a  $<$ .

```
3  1  -1.0  -1  2  3  4  lat=1
.
F4:N    (3 < 3 [0 0 0])
```

**CHAPTER 3**  
**DATA CARDS**

*Universe format:* The universe format, U=#, is a shorthand method of including all cells and lattice elements filled by universe #. This format can be used in any level of the tally chain. The following example illustrates valid shorthand U=# descriptions in the left column. The right column shows the tally after the shorthand has been expanded. Cells 4 and 5 are filled with universe 1.

	<u>shorthand</u>	<u>expanded</u>
F4:N	u=1	4 5
	(u=1)	(4 5)
	(u=1 < 2 < 3)	(4 5 < 2 < 3)
	((u = 1) < 2 < 3)	((4 5) < 2 < 3)
	(1 < u = 1 < 2 < 3)	(1 < 4 5 < 2 < 3)
	(1 < (u = 1) < 2 < 3)	(1 < (4 5) < 2 < 3)

In complex geometries, the U=# format should be used sparingly, especially with the multiple bin format. If 100 cells are filled by universe 1 and 10 cells are filled by universe 2, then the tally

$$F4:N \quad (u = 1 < u = 2)$$

will create 1000 output tally bins. However,

$$F4:N \quad ((u = 1) < (u = 2))$$

will create only one output tally bin.

*Use of SDn card:* When making tallies in repeated structure and lattice geometries, often a volume or area is required and MCNP will be unable to calculate it. Possibly the geometry causes the calculation to fail. A universe can be repeated a different number of times in different cells and the code has no way to determine this. There are two distinct options for entries on the SDn card relating to repeated structures and they cannot be mixed within a single tally.

The first option is to enter a value for each first level entry on the related F card. If the entry on the F card is the union of cells, the SD card value will be the volume of the union of the cells. The following examples illustrate Fn card tally descriptions in the left column. The right column shows the SDn card entries.

F4:N	(1 < 4 5 6 < 7 8)	SD4	$V_1$
	(1 2 3 < 4 5 6 < 7 8)		$V_1 V_2 V_3$
	(1 2 3 < (4 5 6) < (7 8))		$V_1 V_2 V_3$
	((1 2 3) < 4 5 6 < 7 8)		$V_{123L}$

$V_i$  = volume of cell  $i$  and  $V_{123}$  = volume of the union of cells 1, 2, and 3. Even though the first line creates six tally bins, only one SD value is entered. This divisor is applied to all bins generated by the input tally bin. You do not need to know the number of bins generated by each input tally bin

in order to use the SD card. The last line is the union of cells 1, 2, and 3 and only one divisor is entered on the SD card.

The second option is to enter a value for each bin generated by the Fn card.

F4:N (1 < 4 5 6 < 7 8)	SD4	$V_1^1 V_1^2 V_1^3 V_1^4 V_1^5 V_1^6$
(1 2 3 < 4 5 6 < 7 8)		$V_1^1 V_2^2 V_3^3 V_1^4 V_2^5 V_3^6 V_1^7 \dots V_1^{16} V_2^{17} V_3^{18}$
(1 2 3 < (4 5 6) < (7 8))		$V_1 V_2 V_3$
((1 2 3) < 4 5 6 < 7 8)		$V_{123}^1 V_{123}^2 V_{123}^3 V_{123}^4 V_{123}^5 V_{123}^6$

$V_1^j$  = volume of cell  $i$  for bin  $j$  and  $V_{123}^j$  = volume of the union of cells 1, 2, and 3 for bin  $j$ . If cell  $i$  is repeated the same number of times in all six bins generated by the first line above, then all six SD values for this input bin will be the same ( $V_1^1 = V_1^2 = V_1^3 \dots$ ). However, if cell 1 is repeated a different number of times in each bin, then different SD values should be entered. The volume is multiplied by the number of times it is repeated. In these cases, the total cell 1 volume for each generated bin will not be calculated. The bin generation order is explained previously in the Fn card section. For the first line above, the bin order is (1<4<7), (1<5<7), (1<6<7), (1<4<8), (1<5<8), and (1<6<8). The second line above generated 18 tally bins, and 18 SD values are required in the proper sequence. This option requires the knowledge of both the number and sequence of bins generated by each input tally bin.

## 2. FCn Tally Comment Card

Form: FCn any desired information

Default: No comment.

Use: Recommended for modified tally.

Anything entered after FCn will appear as the title heading of tally Fn. This card is particularly useful when tallies are modified in some way, so later readers of the output will be warned of modified or nonstandard tallies. The FCn card can be continued only by blanks in columns 1–5 on succeeding lines. The & continuation symbol is considered as part of the comment, not as a continuation command.

## 3. En Tally Energy Card

Form: En  $E_1 \dots E_k$

$n$  = tally number.

$E_i$  = upper bound (in MeV) of the  $i^{\text{th}}$  energy bin for tally  $n$ .

## CHAPTER 3 DATA CARDS

Default: If the En card is absent, there will be one bin over all energies unless this default has been changed by an E0 card.

Use: Required if EMn card is used.

The entries on the En card must be entered in the order of increasing magnitude. If a particle has an energy greater than the last entry, it will not be tallied, but you will be warned that this has happened. If the last entry is greater than the upper energy limit  $E_{max}$  specified on the PHYS card, the last bin will be lowered to  $E_{max}$ . If there are several bins above  $E_{max}$ , the extra bins are eliminated.

An E0 (zero) card can be used to set up a default energy bin structure for all tallies. A specific En card will override the default structure for tally  $n$ .

MCNP automatically provides the total over all specified energy bins, but the total can be inhibited for a given tally by putting the symbol NT at the end of the En card for that tally. The symbol C at the end of the line causes the bin values to be cumulative and the last energy bin is also the total over all energy.

Example: E11 .1 1 20

This will separate an F11 current tally into four energy bins: (1) from the energy cutoff to 0.1 MeV, (2) from 0.1 to 1.0 MeV, (3) from 1.0 to 20.0 MeV, and (4) a total over all energy.

### 4. Tn Tally Time Card

Form:  $Tn \ T_1 \dots T_k$

$n$  = tally number.

$T_i$  = upper bound (in shakes) of the  $i^{\text{th}}$  time bin for tally  $n$ .

Default: If the Tn card is absent, there will be one bin over all times unless this default has been changed by a T0 card.

Use: Required if TMn card is used. Consider FQn card.

The times on the Tn card must be entered in order of increasing magnitude. If a particle has a time greater than the last entry on the Tn card, it will not be tallied, but you will be warned that this has happened. The last time bin entry should always be less than or equal to the time cutoff (see CUT card) except for point detectors. If time bins greater than the time cutoff are entered for tallies other than point detectors, the first bin limit over the cutoff will be lowered to the cutoff. All higher bins will be eliminated. For point detector tallies, time bins can exceed the time cutoff so that particles will score at detectors remote from the main body of the system. Setting the time cutoff lower than

the last time bin will inhibit unproductive transport of slow neutrons in the system and will increase the efficiency of the problem.

A T0 (zero) card can be used to set up a default time bin structure for all tallies. A specific Tn card will override the default structure for tally *n*.

MCNP automatically provides the total over all specified time bins, but the total can be inhibited for a given tally by putting the symbol NT at the end of the Tn card for that tally. The symbol C at the end of the line causes the bin values to be cumulative and the last time bin is also the total over all time.

Example: T2 -1 1 1.0+37 NT

This will separate an F2 flux surface tally into three time bins: (1) from  $-\infty$  to  $-1.0$  shake, (2) from  $-1.0$  shake to  $1.0$  shake, and (3) from  $1.0$  shake to  $1.0e37$  shakes, effectively infinity. No total bin will be printed in this example.

#### 5. Cn Cosine Card (tally type 1 only)

Form: Cn C<sub>1</sub> ... C<sub>k</sub>

*n* = tally number.

C<sub>*i*</sub> = upper cosine limit of the *i*<sup>th</sup> angular bin for surface current tally *n*.  
C<sub>1</sub> > -1. C<sub>*k*</sub> = 1.

Default: If the Cn card is absent, there will be one bin over all angles unless this default has been changed by a C0 card.

Use: Tally type 1. Required if CMn card is used. Consider FQn card.

The angular limits described by the Cn card are defined with respect to the positive normal to the surface at the particle point of entry. An FTn card with an FRV U V W option can be used to make the cosine bins relative to the vector u,v,w. The positive normal to the surface is always in the direction of a cell that has positive sense with respect to that surface. The cosines must be entered in increasing order, beginning with the cosine of the largest angle less than 180° to the normal and ending with the normal (cos=1). A lower bound of -1 is set in the code and should not be entered on the card. The last entry must always be 1.

A C0 (zero) card can be used to set up a default angular bin structure for all tallies. A specific Cn card will override the default structure for tally *n*. Note that the selection of a single cosine bin for an F1 tally gives the total and not the net current crossing a surface.



## CHAPTER 3 DATA CARDS

MCNP does not automatically provide the total over all specified cosine bins, but the total can be generated for a given tally by putting the symbol *T* at the end of the Cn card for that tally. The symbol *C* at the end of the line causes the bin values to be cumulative and the last cosine bin is also the total over all cosine bins.

Example: C1   -.866   -.5   0   .5   .866   1

This will tally currents within the angular limits (1) 180° to 150°, (2) 150° to 120°, (3) 120° to 90°, (4) 90° to 60°, (5) 60° to 30°, and (6) 30° to 0° with respect to the positive normal. No total will be provided.

As an example of the relation between a surface normal and sense for the C1 card, consider a source at the origin of a coordinate system and a plane (PY) intersecting the +y axis. An entry of 0 and 1 on the C1 card will tally all source particles transmitted through the plane in the 0 to 1 cosine bin (0° to 90°) and all particles scattered back across the plane in the -1 to 0 cosine bin (90° to 180°). A plane (PY) intersecting the -y axis will result in a tally of all source particles transmitted through the second plane in the -1 to 0 bin (90° to 180°) and all particles scattered back across the plane in the 0 to 1 bin (0° to 90°). Note that the positive normal direction for both planes is the same, the +y axis.

### 6. FQn Print Hierarchy Card

Form: FQn  $a_1$   $a_2$  ...  $a_8$

$n$  = tally number

$a_i$  = F—cell, surface, or detector

    D—direct or flagged

    U—user

    S—segment

    M—multiplier

    C—cosine

    E—energy

    T—time

Default: Order as given above.

Use: Recommended where appropriate.

The  $a_i$ 's are the letters representing all eight possible types of tally bins. This card can be used to change the order in which the output is printed for the tallies. For a given tally, the default order is changed by entering a different ordering of the letters, space delimited. An example of this card is in the DEMO example in Chapter 5.

A subset of the letters can be used, in which case MCNP places them at the end of the FQn card and precedes them with the unspecified letters in the default order. The first letter is for the outermost loop of the nest in the tally printout coding. The last two sets of bins make a table: the next to last set goes vertically; the last set of bins goes horizontally in the table.

Note that the default order is a table in E and T; any other bins in a tally will be listed vertically down the output page. Thus if you have a tally with only cell, user, and energy bins, the print for that tally will be a hard-to-read vertical list. Specifying U E as the only entries or last two entries on the FQn card will produce the same output, but in an easy-to-read table.

An FQ0 (zero) card can be used to change the default order for all tallies. A specific FQn card will then override that order for tally number  $n$ .

An example of this card is in the DEMO example in Chapter 5.

### 7. FMn Tally Multiplier Card

Form: FMn (bin set 1) (bin set 2) ... T

$n$  = tally number  
 (bin set  $i$ ) = ((multiplier set 1) (multiplier set 2) ... (attenuator set))  
 $T$  = absent for no total over bins  
 = present for total over all bins  
 $C$  = cumulative tally bins

attenuator set = C -1  $m_1$   $px_1$   $m_2$   $px_2$  ...  
 multiplier set  $i$  = C  $m$  (reaction list 1) (reaction list 2) ...  
 special multiplier set  $i$  = C - $k$

$C$  = multiplicative constant  
 -1 = flag indicating attenuator rather than multiplier set  
 $m$  = material number identified on an Mm card  
 $px$  = density times thickness of attenuating material;  
 atom density if positive, mass density if negative  
 $k$  = special multiplier option;  
 (reaction list  $i$ ) = sums and products of ENDF or  
 special reaction numbers, described below.

Parentheses:

1. If a given multiplier set contains only one reaction list, the parentheses surrounding the reaction list can be omitted. Parentheses within a reaction list are forbidden.

## CHAPTER 3 DATA CARDS

2. If a given bin set consists of more than a single multiplier or attenuator set, each multiplier or attenuator set must be surrounded by parentheses, and the combination must also be surrounded by parentheses.
3. If the FMn card consists only of a single bin set, and that bin set consists only of a single multiplier or attenuator bin, surrounding parentheses can be omitted.

Default: If the  $C$  entry is negative (for type 4 tally only),  $C$  is replaced by  $/C/$  times the atom density of the cell where the tally is made.

Use: Optional. Use the attenuators only when they are thin. Use only the multiplicative constant for tally types 6 and 7. Disallowed for tally type 8.

The FMn card is used to calculate any quantity of the form

$$C \int \varphi(E) R_m(E) dE,$$

where  $\varphi(E)$  is the energy-dependent fluence (particles/cm<sup>2</sup>) and  $R(E)$  is an operator of additive and/or multiplicative response functions from the MCNP cross-section libraries or specially designated quantities. Note that some MCNP cross-section library reaction numbers are different from ENDF/B reaction numbers. See below. The constant  $C$  is any arbitrary scalar quantity that can be used for normalization. The material number  $m$  must appear on an Mm card, but need not be used in a geometrical cell of the problem.

A reaction list consists of one or more reaction numbers delimited by spaces and/or colons. A space between reaction numbers means multiply the reactions. A colon means add the reactions. The hierarchy of operation is multiply first and then add. One bin is created for each reaction list. Thus, if  $R_1$ ,  $R_2$ , and  $R_3$  are three reaction numbers, the form  $R_1 R_2 : R_3$  represents one reaction list (one bin) calling for reaction  $R_3$  to be added to the product of reactions  $R_1$  and  $R_2$ . No parentheses are allowed within the reaction list. The product of  $R_1$  with the sum of  $R_2$  and  $R_3$  would be represented by the form  $R_1 R_2 : R_1 R_3$  rather than by the form  $R_1 (R_2 : R_3)$ . The latter form would produce two bins with quite a different meaning (see Examples 1 and 2 below).

The reaction cross sections are *microscopic* (with units of barns) and not macroscopic. Thus, if the constant  $C$  is the atomic density (in atoms per barn · cm), the results will include the normalization “per cm<sup>3</sup>.” The examples in Chapter 4 illustrate the normalization.

Any number of ENDF/B or special reactions can be used in a multiplier set as long as they are present in the MCNP cross-section libraries, or in special libraries of dosimetry data. If neither a material nor any reactions are given, the tally is multiplied by the constant  $C$ .

A multiplier set that has only two entries,  $C -k$ , has special meaning. If  $k = -1$ , the tally is multiplied by  $1/\text{weight}$  and the tally is the number of tracks (or collisions for the F5 tally.) If  $k = -2$ , the tally is multiplied by  $1/\text{velocity}$  and the tally is the neutron population integrated over

time, or the prompt removal lifetime. See Chapter 2 page 2–169, Chapter 4 example 3 page 4–39 and the KCODE problem in Chapter 5.

In addition to most of the approximately one hundred standard ENDF reaction numbers available (for example,  $R = 1, 2, 16$ , representing  $\sigma_{tot}$ ,  $\sigma_{el}$ ,  $\sigma_{n,2n}$ ), the following nonstandard special  $R$  numbers may be used:

- Neutrons:
  - 1 total cross section without thermal
  - 2 absorption cross section
  - 3 elastic cross section without thermal
  - 4 average heating number (MeV/collision)
  - 5 gamma-ray production cross section, barns
  - 6 total fission cross section
  - 7 fission  $\nu$
  - 8 fission  $Q$  (MeV/fission)
- Photons:
  - 1 incoherent scattering cross section
  - 2 coherent scattering cross section
  - 3 photoelectric cross section
  - 4 pair production cross section
  - 5 total cross section
  - 6 photon heating number
- Multigroup:
  - 1 total cross section
  - 2 fission cross section
  - 3 nubar data
  - 4 fission chi data
  - 5 absorption cross section
  - 6 stopping powers
  - 7 momentum transfers

A list of many of the ENDF reaction numbers can be found in Appendix G. The total and elastic cross sections,  $R = 1$  and  $R = 2$ , are adjusted for temperature dependence. All other reactions are interpolated directly from the library data tables. Note that for tritium production, the  $R$  number differs from one nuclide to another. Note also that tally types 6 and 7 already include reactions, so the FMn card makes little sense for  $n = 6$  or 7. Only the constant-multiplier feature should be used for these tally types, generally. Photon production reactions can be specified according to the MTRP prescription in Table F.6 in Appendix F.

An attenuator set of the form  $C \ 1 \ m \ px$ , where  $m$  is the material number and  $px$  is the product of density and thickness, allows the tally to be modified by the factor  $e^{-\sigma_{tot}px}$  representing an exponential line-of-sight attenuator. This capability makes it possible to have attenuators without

## CHAPTER 3 DATA CARDS

actually modeling them in the problem geometry. **Caution:** The assumption is made that the attenuator is thin, so that simple exponential attenuation without buildup from scattering is valid.

The attenuator set can include more than one layer:

$$C \quad -1 \quad m_1 \quad px_1 \quad m_2 \quad px_2$$

in which case the factor is  $e^{-\sigma_1 px_1 - \sigma_2 px_2}$ . The attenuator set can also be part of a bin set, for example,

$$((C_1 \quad m_1 \quad R_1) (C_2 \quad m_2 \quad R_2) (C_3 \quad -1 \quad m_3 \quad px_3))$$

in which case the attenuation factor is applied to every bin created by the multiplier sets. Note that both the inner and the outer parentheses are required for this application.

Tallies are posted in all multiplier bins for each score. MCNP does not automatically provide the total over all specified multiplier bins for a particular tally. The total is available for a tally, however, by putting the symbol *T* at the end of the FMn card for that tally.

In perturbed problems (see PERT card, page 3–141), the perturbation keyword RXN can affect the cross sections used with the FM card tally multipliers. If a tally in a cell is dependent on a cross section that is perturbed, then  $R_{ij'} \neq 0$  and a correction is made to the  $R_{ij'} = 0$  case (see page 2-XII.A.??.) For this required  $R_{ij'}$  correction to be made, the user must ensure that the R reactions on the FM card are the same as the RXN reactions on the PERT card AND that the FM card multiplicative constant *C* is negative, indicating multiplication by the atom density to get macroscopic cross sections. For example, if  $R = -6$  for fission on the FM card, you should not use RXN=18 for fission on the PERT card. If  $C > 0$ , the cross sections are not macroscopic, it is assumed that there is no tally dependence on a perturbed cross section,  $R_{ij'} = 0$ , and no correction is made. The same  $R_{ij'} \neq 0$  correction is automatically made for the F6 tally and the KCODE  $k_{eff}$  calculation, and for an F7 tally if the perturbation reaction is fission because these three tallies all have implicit associated FM cards

Example 1: FMn *C* *m*  $R_1 R_2 : R_1 R_3$

Example 2: FMn *C* *m*  $R_1 (R_2 : R_3)$

These two examples reiterate that parentheses cannot be used for algebraic hierarchy within a reaction list. The first example produces a single bin with the product of reaction  $R_1$  with the sum of reactions  $R_2$  and  $R_3$ . The second case creates two bins, the first of which is reaction  $R_1$  alone; the second is the sum of  $R_2$  and  $R_3$ , without reference to  $R_1$ .

Example 3: F2:N    1    2    3    4  
               FM2    ( $C_1$ )    ( $C_2$ )    ( $C_3$ )    ( $C_4$ )     $T$

Example 4: F12:N    1    2    3    4  
               FM12     $C_1$

Example 5: F22:N    (1 2 3)    4     $T$   
               FM22    ( $C_1$ ) ( $C_2$ ) ( $C_3$ ) ( $C_4$ )

These three examples illustrate the syntax when only the constant-multiplier feature is used. All parentheses are required in these examples. Tally 2 creates 20 bins: the flux across each of surfaces 1, 2, 3, and 4 with each multiplied by each constant  $C_1$ ,  $C_2$ ,  $C_3$ ,  $C_4$ , and the sum of the four constants. Tally 12 creates 4 bins: the flux across each of surfaces 1, 2, 3, and 4 with each multiplied by the constant  $C_1$ . Tally 22 creates 12 bins: the flux across surface 1 plus surface 2 plus surface 3, the flux across surface 4, and the flux across all four surfaces with each multiplied by each constant  $C_1$ ,  $C_2$ ,  $C_3$ , and  $C_4$ . An FQn card with an entry of F M or M F would print these bins of the tallies in an easy-to-read table rather than strung out vertically down the output page.

Several more examples of the FMn card are in Chapter 4. The DEMO example in Chapter 5 also illustrates the general form of the card.

Using MCNP tallies, there are two ways to obtain the energy deposited in a material in terms of rads (1 rad = 100 ergs/g). When the actual material of interest is present in the MCNP model, the simplest way is to use the heating tally with units MeV/g in conjunction with  $C=1.602E-08$  on the companion FMn card, where  $C=(1.602E-06 \text{ ergs/MeV})/(100 \text{ ergs/g})$ . When the material is not present in the model, rads can be obtained from type 1, 2, 4, and 5 tallies by using an FMn card where  $C$  is equal to the factor above times  $N_o \eta \times 10^{-24} / A$ , where  $N_o$  is Avogadro's number and  $\eta$  and  $A$  are the number of atoms/molecule and the atomic weight, respectively, of the material of interest. This value of  $C$  equals  $\rho_a / \rho_g$  as discussed on page 2-82. The implicit assumption when the material is not present is that it does not affect the radiation transport significantly. In the reaction list on the FM card, you must enter -4 1 for neutron heating and -5 -6 for photon heating. See page 2-82 and 4-38 for examples. For both F4 and F6, if a heating number from the data library is negative, it is set to zero by the code.

8. DEn Dose Energy Card  
DFn Dose Function Card

Form:        DEn    A     $E_1$  ...  $E_k$   
               DFn    B     $F_1$  ...  $F_k$

$n$     =    tally number.  
 $E_i$     =    an energy (in MeV).  
 $F_i$     =    the corresponding value of the dose function.

### CHAPTER 3 DATA CARDS

- A = LOG or LIN interpolation method for energy table.
- B = LOG or LIN interpolation method for dose function table.

Defaults: If A or B is missing, LOG is chosen for that table.

Use: Tally comment recommended.

This feature allows you to enter a pointwise response function (such as flux-to-dose conversion factors) as a function of energy to modify a regular tally. Both cards must have the same number of numerical entries and they must be monotonically increasing in energy. Particle energies outside the energy range defined on these cards use either the highest or lowest value.

By default MCNP uses log-log interpolation between the points rather than a histogram function as is done for the EMn card. The energy points specified on the DEn card do not have to equal the tally energy bins specified with the En card for the Fn tally. Unlike EMn card use, there can be many points on the DEn and DFn cards, but the response can be tallied in only a few energy bins such as one unbounded energy bin.

If  $n$  is zero on these two cards, the function will be applied to all tallies that do not have DEn and DFn cards specifically associated with them.

LIN or LOG can be chosen independently for either table. Thus any combination of interpolation (log-log, linear-linear, linear-log, or log-linear) is possible. The default log-log interpolation is appropriate for the ANSI/ANS flux-to-dose rate conversion factors (they are listed in Appendix H); kermas for air, water, and tissue; and energy absorption coefficients.

Example: DE5             $E_1 E_2 E_3 E_4 \dots E_k$   
          DF5    LIN    $F_1 F_2 F_3 F_4 \dots F_k$

This example will cause a point detector tally to be modified according to the dose function  $F(E)$  using logarithmic interpolation on the energy table and linear interpolation on the dose function table.

#### 9. EMn Energy Multiplier Card

Form:        EMn     $M_1 \dots M_k$

$n$  = tally number.

$M_i$  = multiplier to be applied to the  $i^{\text{th}}$  energy bin.

Default:    None.

Use:        Requires En card. Tally comment recommended.

This card can be used with any tally (specified by  $n$ ) to scale the usual current, flux, etc. by a response function. There should be one entry for each energy entry on the corresponding En card. When a tally is being recorded within a certain energy bin, the regular contribution is multiplied by the entry on the EMn card corresponding to that bin. For example, a dose rate can be tallied with the appropriate response function entries. Tallies can also be changed to be per unit energy if the entries are  $1/\Delta E$  for each bin. Note that this card modifies the tally by an energy-dependent function that has the form of a histogram and not a continuous function. It also requires the tally to have as many energy bins as there are histograms on the EMn card. If either of these two effects is not desired, see the DEn and DF<sub>n</sub> cards.

A set of energy multipliers can be specified on an EM0 (zero) card that will be used for all tallies for which there is not a specific EMn card.

10. TMn Time Multiplier Card

Form:        TMn     $M_1 \dots M_k$   
                $n$     = tally number.  
                $M_i$  = multiplier to be applied to the  $i^{\text{th}}$  time bin.  
 Default:    None.  
 Use:         Requires Tn card. Tally comment recommended.

This card is just like the EMn card except that the entries multiply time bins rather than energy bins. The Tn and TMn cards must have the same number of entries. Note that this card modifies the tally by a time-dependent function that has the form of a histogram and not a continuous function.

A set of time multipliers can be specified on a TM0 (zero) card that will be used for all tallies for which there is not a specific TMn card.

For example, if the entries are  $1/\Delta T$ , where  $\Delta T$  is the width of the corresponding time bin, the tally will be changed to be per unit time with the units of  $1/\Delta T$ .

11. CMn Cosine Multiplier Card (tally type 1 only)

Form:        CMn     $M_1 \dots M_k$   
                $n$     = tally number.  
                $M_i$  = multiplier to be applied to the  $i^{\text{th}}$  cosine bin.  
 Default:    None.  
 Use:         Tally type 1. Requires Cn card. Tally comment recommended.



## CHAPTER 3 DATA CARDS

This card is just like the EMn and TMn cards except that the entries multiply cosine bins. The number of entries on the CMn card must be the same as on the Cn card. Note that this card modifies the tally by an angular-dependent function that has the form of a histogram and not a continuous function.

A set of cosine multipliers can be specified on a CM0 (zero) card that will be used for all type 1 tallies for which there is not a specific CMn card.

For example, if you want the directionally dependent F1 tally results to be per steradian, the  $i^{\text{th}}$  entry on the CM1 card is

$$\frac{1}{2\pi(\cos\theta_i - \cos\theta_{i-1})}$$

where  $\theta_o$  is  $180^\circ$ .

### 12. CFn Cell-Flagging Card (tally types 1, 2, 4, 6, 7)

Form:        CFn     $C_1 \dots C_k$   
               $n$     = tally number.  
               $C_i$    = problem cell numbers whose tally contributions are to be flagged.

Default:    None.

Use:         Not with detectors or pulse height tallies. Consider FQn card.

Particle tracks can be “flagged” when they leave designated cells and the contributions of these flagged tracks to a tally are listed separately in addition to the normal total tally. This method can determine the tally contribution from tracks that have passed through an area of interest.

Cell flagging cannot be used for detector tallies. The same purpose can be accomplished with an FTn card with the ICD option.

The cell flag is turned on only upon leaving a cell. A source particle born in a flagged cell does not turn the flag on until it leaves the cell.

In MODE N P the flagged neutron tallies are those caused by neutrons leaving the flagged cell, but the flagged photon tallies can be caused by either a photon leaving a flagged cell or a neutron leaving a flagged cell and then leading to a photon which is tallied.

Example: F4:N    6    10    13  
          CF4    3    4

In this example the flag is turned on when a neutron leaves cell 3 or 4. The print of Tally 4 is doubled. The first print is the total track length tally in cells 6, 10, and 13. The second print is the tally in these cells for only those neutrons that have left cell 3 or 4 at some time before making their contribution to the cell 6, 10, or 13 tally.

13. SFn Surface-Flagging Card (tally types 1, 2, 4, 6, 7)

Form:        SFn     $S_1 \dots S_k$

$n$     =    tally number.

$S_i$    =    problem surface numbers whose tally contributions are to be flagged.

Default:    None.

Use:         Not with detectors. Consider FQn card.

This feature is identical to cell flagging except that particles turn the flag on when they cross the specified surfaces. Thus a second tally print is given for only those particles that have crossed one or more of the surfaces specified on the SFn card.

Surface flagging cannot be used for detector tallies but an FTn card with the ICD option will do the same thing.

The situation for photon tallies in MODE N P is like that for the CFn card: a photon can be flagged either because it has crossed a flagged surface or because it was created by a neutron that crossed a flagged surface.

Both a CFn and an SFn card can be used for the same tally. The tally is flagged if the track leaves one or more of the specified cells or crosses one or more of the surfaces. Only one flagged output for a tally is produced from the combined CFn and SFn card use.

14. FSn Tally Segment Card (tally types 1, 2, 4, 6, 7)

Form:        FSn     $S_1 \dots S_k$

$n$     =    tally number.

$S_i$    =    signed problem number of a segmenting surface.

Default:    No segmenting.

Use:         Not with detectors. May require SDn card. Consider FQn card.

## CHAPTER 3 DATA CARDS

This card allows you to subdivide a cell or a surface into segments for tallying purposes, the advantage being that it is then not necessary to specify the problem geometry with extra cells just for tallying. The segmenting surfaces specified on the FS*n* card are listed with the regular problem surfaces, but they need not be part of the actual geometry and hence do not complicate the cell/surface relationships.

If  $k$  surfaces are entered on the FS*n* card,  $k + 1$  surface or volume segments are created. Tally  $n$  is subdivided into  $k + 1$  segment bins according to the order and sense of the segmenting surfaces listed on the FS*n* card. If the symbol  $T$  is on the FS*n* card, there will be an additional total bin. The symbol  $C$  at the end of the FS card causes the bin values to be cumulative. Segmenting is done according to the following scheme:

Fn:N     $S$     (or  $C$ )  
FS*n*     $S_1 \dots S_k T$  (optional)

Tally  $n$  over surface  $S$  (or in cell  $C$ ) will be subdivided into the following bins:

1. the portion with the same sense with respect to surface  $S_1$  as the sign given to  $S_1$ ,
2. the portion with the same sense with respect to surface  $S_2$  as the sign given to  $S_2$  but excluding that already scored in a previously listed segment,
- .
- $k$  the portion with the same sense with respect to surface  $S_k$  as the sign given to  $S_k$  but excluding that already scored in a previously listed segment,
- $k+1$  everything else,
- $k+2$  entire surface or cell if  $T$  is present on FS*n* card.

If the symbol  $T$  is absent from the FS*n* card, the  $(k+2)^{\text{th}}$  bin is missing and MCNP calculates the tally only for each segment (including the “everything else” segment). If multiple entries are on the Fn card, each cell or surface in the tally is segmented according to the above rules. For tally types 1 or 2, the segmenting surfaces divide a problem surface into segments for the current or flux tallies. The segmenting surfaces divide a problem cell into segments for tally types 4, 6, or 7. For normalized tallies, the segment areas (for type 2), volumes (for type 4), or masses (for types 6 and 7) may have to be provided. See the discussion under the SD*n* card.

Example 1:      F2:N    1  
                  FS2    -3  -4

This example subdivides surface 1 into three sections and calculates the neutron flux across each of them. There are three prints for the F2 tally: (1) the flux across that part of surface 1 that has negative sense with respect to surface 3, (2) the flux across that part of surface 1 that has negative sense with respect to surface 4 but that has not already been scored (and so must have positive sense with respect to surface 3), (3) everything else (that is, the flux across surface 1 with positive sense with respect to both surfaces 3 and 4).

It is possible to get a zero score in some tally segments if the segmenting surfaces and their senses are not properly specified. In Example 1 above, if all tallies that are positive with respect to surface 3 are also all positive with respect to surface 4, the second segment bin will have no scores.

Example 2:      F2:N    1  
                  FS2    -3 4

The order and sense of the surfaces on the FS2 card are important. This example produces the same numbers as does Example 1 but changes the order of the printed flux. Bins two and three are interchanged.

Example 3:      F1:N    1 2 *T*  
                  FS1    -3 *T*

This example produces three current tallies: (1) across surface 1, (2) across surface 2, and (3) the sum across surfaces 1 and 2. Each tally will be subdivided into three parts: (1) that with a negative sense with respect to surface 3, (2) that with a positive sense with respect to surface 3, and (3) a total independent of surface 3.

Several additional examples of the FS<sub>n</sub> card are in Chapter 4.

15. SD<sub>n</sub> Segment Divisor Card (tally types 1, 2, 4, 6, 7)

Form:            SD<sub>n</sub>    (*D*<sub>11</sub> *δ*<sub>2</sub> ... *D*<sub>1*m*</sub>) (*D*<sub>21</sub> *D*<sub>22</sub> ... *D*<sub>2*m*</sub>)... (*D*<sub>*k*1</sub> *D*<sub>*k*2</sub> ... *D*<sub>*k**m*</sub>)

- n*    = tally number. *n* cannot be zero.
- k*    = number of cells or surfaces on F<sub>n</sub> card, including *T* if present.
- m*    = number of segmenting bins on the FS<sub>n</sub> card, including the remainder segment, and the total segment if FS<sub>n</sub> has a *T*.
- D*<sub>*ij*</sub> = area, volume, or mass of *j*<sub>th</sub> segment of the *i*<sub>th</sub> surface or cell bin for tally *n*.

The parentheses are optional.

Hierarchy for obtaining volume, area, or mass:

1. For cell or surface without segmenting (tally types 2, 4, 6, and 7):
  - a. nonzero entry on SD<sub>n</sub> card,
  - b. nonzero entry on VOL or AREA card,
  - c. volume, area or mass calculated by MCNP,
  - d. fatal error
2. For cell or surface with segmenting (tally types 2, 4, 6, and 7):
  - a. nonzero entry on SD<sub>n</sub> card,
  - b. volume, area or mass calculated by MCNP
  - c. fatal error

## CHAPTER 3 DATA CARDS

3. For surface in a type 1 tally:
  - a. nonzero entry on SDn card,
  - b. no divisor.

Use: Not with detectors. May be required with FSn card. Can be used without FSn card.

For segmented cell volumes or surface areas defined by the FSn card that are not automatically calculated by MCNP, the user can provide volumes, areas, or masses on this segment divisor card to be used by tally  $n$ . This card is similar to the VOL and AREA cards but is used for specific tallies, whereas the other two are used for the entire problem geometry. For tally type 2 the entry is area, for tally type 4 the entry is volume, and for tally types 6 and 7 the entries are masses. Tally type 1 (the current tally) is not normally divided by anything, but with the SD1 card the user can introduce any desired divisor, for example, area to tally surface current density.

Example    F4:N    1 2 3  $T$   
              SD4    1 1 1 1

Note that the SDn card can be used to define tally divisors even if the tally is not segmented. In this example the tally calculates the flux in the three cells plus the union of the three cells. The VOL card can be used to set the volume divisor of the three cells (to unity, for example), but it cannot do anything about the divisor for the union. Its divisor is the sum of the volumes (whether MCNP-calculated or user-entered) of the three cells. But the divisors for all four of the cell bins can be set to unity by means of the SDn card. These entries override entries on the VOL and AREA cards. See page 3–82 for use with repeated structure tallies.

### 16. FUn TALLYX Input Card

Form:        FUn     $X_1$   $X_2$  ...  $X_k$   
or:         FUn    *blank*

$n$     =    tally number.

$X_i$    =    input parameter establishing user bin  $i$ .

Default:    If the FU card is absent, subroutine TALLYX is not called.

Use:         Used with a user-supplied TALLYX subroutine or FTn card.

This card is used with a user-supplied tally modification subroutine TALLYX and some cases of the FTn card. If the FUn card has no input parameters, TALLYX will be called but no user bins will be created. The  $k$  entries on the FUn card serve three purposes: (1) each entry establishes a separate user tally bin for tally  $n$ , (2) each entry can be used as an input parameter for TALLYX to define the user bin it establishes, and (3) the entries appear in the output as labels for the user bins. IPTAL(LIPT+3,1,ITAL) is the pointer to the location in the TDS array of the word preceding the location of the data entries from the FUn card. Thus if the FUn card has the form shown above,

$$\begin{aligned} \text{TDS}(\text{L}+1) &= X_1 \\ \text{TDS}(\text{L}+2) &= X_2 \\ &\vdots \\ \text{TDS}(\text{L}+k) &= X_k \end{aligned}$$

where

$$\begin{aligned} \text{L} &= \text{IPTAL}(\text{LIPT}+3,1,\text{ITAL}) \\ k &= \text{IPTAL}(\text{LIPT}+3,4,\text{ITAL}) - 1 \\ &= \text{IPTAL}(\text{LIPT}+3,3,\text{ITAL}) - 1 \\ n &= \text{JPTAL}(\text{LJPT}+1,\text{ITAL}) \\ \text{ITAL} &= \text{program number of the tally} \end{aligned}$$

MCNP automatically provides the total over all specified user bins. The total can be inhibited for a tally by putting the symbol NT at the end of the FUn card for that tally as follows:

FUn  $X_1 X_2 \dots X_k$  NT

and there is one change in the preceding list of variables:

$$\begin{aligned} k &= \text{IPTAL}(\text{LIPT}+3,4,\text{ITAL}) - 1 \\ &= \text{IPTAL}(\text{LIPT}+3,3,\text{ITAL}) \end{aligned}$$

The symbol C at the end of the FU card causes the bin values to be cumulative in which case

$$\begin{aligned} \text{IPTAL}(\text{LIPT}+3,3,\text{ITAL}) &= \text{IPTAL}(\text{LIPT}+3,4,\text{ITAL}) \\ \text{IPTAL}(\text{LIPT}+3,6,\text{ITAL}) &= 1. \end{aligned}$$

The discussion of the IPTAL and JPTAL arrays in Appendix E and the following description of TALLYX may be useful.

*SUBROUTINE TALLYX User-supplied Subroutine*

Use: Called for tally n only if an FUn card is in the INP file.

TALLYX is called whenever a tally with an associated FUn card but no FTn card is scored. The locations of the calls to TALLYX are such that TALLYX is the very last thing to modify a score before it is posted in the tally. TALLYX calls can be initiated by more than one FUn card for different values of n; a branch must be constructed inside the subroutine based on which tally Fn is calling TALLYX, where  $n = \text{JPTAL}(\text{LJPT}+1,\text{ITAL})$ . TALLYX has the following form:

```

SUBROUTINE TALLYX(T,IB)
*CALL CM
User-supplied FORTRAN statements

```

## CHAPTER 3 DATA CARDS

RETURN  
END

The quantity  $T$  (first argument of TALLYX) that is scored in a standard tally can be multiplied or replaced by anything. The modified score  $T$  is then put into one of the  $k$  user bins established by the FUn card. In TALLYX(T,IB) the second argument IB is defined to allow for more than one pass through TALLYX per tally score. By default, IB=0, which means make one pass through the MCNP coding where user bin tally scores are posted. If the user sets IB<0 in TALLYX, no score will be made. If the user sets IB>0, passes through the user bin loop including TALLYX will be made until IB is reset to zero. This scheme allows for tally modification and posting in more than one user bin. The variable IBU is the variable designating the particular user bin established by the FUn card. Its value is 1 before the first pass through the user bin loop. The indices of the current user, segment, cosine, energy, and time bins (IBU, IBS, IBC, IBE, and IBT, respectively) and the flag JBD that indicates flagged- or direct-versus-not are in Common for optional modification by TALLYX. Note that the index of the multiplier bin is not available and cannot be modified. NTX is a variable in blank Common. It is set equal to NX just before the CALL TALLYX in TALLYD and TALLY. The variable NX is set to unity just before the start of the user bins loop and is incremented after the CALL TALLYX, so NTX contains the number of the TALLYX call. An example of using NTX to tally in every user bin before leaving the user bin loop follows:

```
      SUBROUTINE TALLYX(T,IB)
*CALL  CM
      T = whatever
      IBU = NTX
      IB = 1
      IF(NTX.GE.IPTAL(LIPT+3,4,ITAL)-1) IB = 0
      RETURN
      END
```

If IBU is out of range, no score is made and a count of out-of-range scores is incremented. If excessive loops through TALLYX are made, MCNP assumes IB has been incorrectly set and terminates the job with a BAD TROUBLE error (excessive is greater than the product of the numbers of bins of all kinds in the tally). Several examples of the FUn card and TALLYX are in Chapter 4. The procedure for implementing a TALLYX subroutine is the same as for the user-provided SOURCE subroutine.

### 17. TF<sub>n</sub> Tally Fluctuation Card

Form:      TF<sub>n</sub>     $I_1 \dots I_8$

$n$     = tally number.  $n$  cannot be zero.  
 $I_i$    = bin number for bin type  $i$ .     $1 \leq I_i \leq last$   
 $last$  = IPTAL(LIPT+i,3,ITAL)

= total number of bins in one of the eight bin types.

Default: 1 1 *last last* 1 *las last last*

1. first cell, surface, or detector on Fn card
2. total rather than flagged or uncollided flux
3. last user bin
4. last segment bin
5. first multiplier bin on FMn card
6. last cosine bin
7. last energy bin
8. last time bin.

Use: Whenever one or more tally bins are more important than the default bin. Particularly useful in conjunction with the weight window generator.

At the end of the output, one chart for each tally is printed to give an indication of tally fluctuations; that is, how well the tally has converged. The tally mean, relative error, variance of the variance, Pareto slope (see page 2-118), and figure of merit ( $FOM = 1/(\sigma^2 t)$ , where  $\sigma$  is the relative error printed with the tally and  $t$  is computer time in minutes) are printed as functions of the number of histories run. The *FOM* should be roughly constant. The TF card determines for which bin in tally  $n$  the fluctuations are printed. It also determines which tally bin is optimized by the weight window generator (WWE and WWG cards).

The TFn card allows you to change the default bin for a given tally and specify for which tally bin the chart and all the statistical analysis output will be printed. The eight entries on the card correspond (in order) to the list of bin indices for the eight dimensions of the tally bins array. The order is fixed and not affected by an FQn card.

The mean printed in a chart will correspond to some number in the regular tally print. If you have more than one surface listed on an F2 card, for example, the chart will be for the first surface only; charts can be obtained for all surfaces by having a separate tally for each surface.

You may find the *J* feature useful to jump over *last* entries. Remember that totals are calculated for energy, time, and user bins (unless inhibited by using NT), so that *last* for eight energy bins is 9. If one segmenting surface divides a cell or surface into two segments, *last* in that case is 2, unless *T* is used on the FS card, in which case *last* is 3. If there are no user bins or cosine bins, for example, *last* is 1 for each; *last* is never less than 1.

Example: Suppose an F2 tally has four surface entries, is segmented into two segments (the segment plus everything else) by one segmenting surface, and has eight energy bins. By default one chart will be produced for the first surface listed, for the part outside the segment, and totaled over energy. If we wish a chart for the fifth energy bin of the third surface in the first segment, we would use TF2 3 2J 1 2J 5.



## CHAPTER 3 DATA CARDS

### 18. DDn Detector Diagnostics Card

Form: DDn  $k_1$   $m_1$   $k_2$   $m_2$  ...

- $n$  = 1 for neutron DXTRAN spheres
- = 2 for photon DXTRAN spheres
- = tally number for specific detector tally
- $k_i$  = criterion for playing Russian roulette for detector  $i$
- $m_i$  = criterion for printing large contributions

Defaults: If  $k_i$  is not specified on a DDn card,  $k_i$  on the DD card is used. If that is not specified,  $k_i$  on the DD card is used. If that is not specified,  $k_i = 0.1$  is used. A similar sequence of defaults defines  $m_i$ , with a final default of  $m_i = 1000$ .

Use: Optional. Remember that Russian roulette will be played for detectors and DXTRAN unless specifically turned off by use of the DD card. Consider also using the PDn or DXC cards.

This card (1) using a Russian roulette game, can speed up calculations significantly by limiting small contributions that are less than some fraction  $k$  of the average contribution per history to detectors or DXTRAN spheres, and (2) can provide more information about the origin of large contributions or the lack of a sufficient number of collisions close to the detector or DXTRAN sphere. The information provided about large contributions can be useful for setting cell importances or source-biasing parameters.

For a given detector or DXTRAN sphere, the Russian roulette criterion works as follows:

1. If  $k_i$  is positive, all contributions to the detector or sphere are made for the first 200 histories. Then the average contribution per history is computed (and will be updated from time to time throughout the problem). Thereafter, any contribution to the detector or sphere larger than  $k_i$  times this average contribution will always be made, but any contribution smaller than  $k_i$  times the average will be subject to the Russian roulette game. ( $k_i$  is not allowed to be greater than 1.)
2. If  $k_i$  is negative, contributions larger than  $|k_i|$  will always be made, and contributions smaller than  $|k_i|$  will be subject to Russian roulette. This rule applies to all histories from the beginning of the problem, and the 200th history has no significance.
3. If  $k_i$  is zero, no Russian roulette game will be played for the detector or sphere.

Probably,  $k = 0.5$  is suitable for most problems; the nonzero default value 0.1 means that the game is *always played unless explicitly turned off by the user*.

The second entry,  $m_i$ , determines the condition for printing diagnostics for large contributions. If the entry is zero, there is no diagnostic print. If the entry is positive, two possibilities exist.

1. If the corresponding  $k_i$  is positive or zero, no diagnostic prints will be made for the first 200 histories. Thereafter, the first 100 contributions larger than  $m_i$  times the average tally per history will be printed.
2. If the corresponding  $k_i$  is negative, the first 100 contributions larger than  $m_i$  times  $|k_i|$  will be printed.

Remember that when  $k_i$  is positive the Russian roulette game is played on the basis of the estimated average contribution per history. Because the estimate improves from time to time, the game is based on different values for different histories. This can make debugging a problem more complicated, and the variance estimate does not quite obey the Central Limit Theorem. A procedure worth considering is to determine the average contribution per history in a preliminary run and then to use some fraction of the negative of this value in subsequent longer runs. The Russian roulette game is played without regard to particle time or energy; thus time and energy bins for which the ultimate tally is small may lose a disproportionate share of scores by the roulette game.

The DD card eliminates tracks with DXTRAN but only contributions with detectors.

```

Example:  DXT:N      x1 y1 z1 RI1 RO1
           x2 y2 z2 RI2 RO2
           x3 y3 z3 RI3 RO3
           DXT:P      x4 y4 z4 RI4 RO4
           F15X:P     a1 r1 R1
           a2 r2 R2
           DD         .2  100 .15  2000
           DD1        -1.1E25  3000  J  J  J  3000
           DD15       .4   10
  
```

Detector/sphere	k	m
sphere 1	-1.1E25	3000
sphere 2	.15	2000
sphere 3	.2	3000
sphere 4	.2	100
detector 1	.4	10
detector 2	.15	2000

Another example of the DD card and a description of its output is in Chapter 5. For a more detailed discussion of the Russian roulette game, see page 2–95 in Chapter 2.

### 19. DXT DXTRAN Card

Form:        DXT:n    x<sub>1</sub> y<sub>1</sub> z<sub>1</sub> RI<sub>1</sub> RO<sub>1</sub> x<sub>2</sub> y<sub>2</sub> z<sub>2</sub> RI<sub>2</sub> RO<sub>2</sub> ... DWC<sub>1</sub> DWC<sub>2</sub> DPWT

## CHAPTER 3 DATA CARDS

$n$  =  $N$  for neutrons,  $P$  for photons, not available for electrons.  
 $x_i y_i z_i$  = coordinates of the point at the center of the  $i^{\text{th}}$  pair of spheres  
 $RI_i$  = radius of the  $i^{\text{th}}$  inner sphere in cm  
 $RO_i$  = radius of the  $i^{\text{th}}$  outer sphere in cm  
 $DWC_1$  = upper weight cutoff in the spheres  
 $DWC_2$  = lower weight cutoff in the spheres  
 $DPWT$  = minimum photon weight. Entered on DXT:N card only.

Defaults: Zero for  $DWC_1$ ,  $DWC_2$ , and  $DPWT$ .

Use: Optional. Consider using the DXC:N, DXC:P, or DD cards when using DXTRAN.

DXTRAN is used to improve the particle sample in the vicinity of a tally (see page 2–152). It should not be misconstrued as a tally itself, such as a detector; it is used in conjunction with tallies as a variance reduction technique. DXTRAN spheres must not overlap. The inner sphere should normally cover the tally region if possible. Specifying a tally cell or surface partly inside and partly outside a DXTRAN sphere usually will make the mean of the tally erratic and the variance huge.

The technique is most effective when the geometry inside the spheres is very simple and can be costly if the inside geometry is complicated, involving several surfaces. The inner sphere is intended to surround the region of interest. The outer sphere should surround neighboring regions that may scatter into the region of interest. In MCNP, the relative importance of the two regions is five. That is, the probability density for scattering toward the inner sphere region is five times as high as the probability density for scattering between the inner and outer spheres. The weight factor is 1/5 for particles scattered toward the inner sphere.

*Rule of Thumb for RI and RO:* The inner radius RI should be at least as large as the tally region, and RO–RI should be about one mean free path for particles of average energy at the spheres. DXTRAN can be used around detectors, but the combination may be very sensitive to reliable sampling.

There can be up to five sets of X Y Z RI RO on each DXT card. There is only one set of  $DWC_1$  and  $DWC_2$  entries for each particle type. This pair is entered after conclusion of the other data and (with DXT:N) before the one value of DPWT. The weight cutoffs apply to DXTRAN particle tracks inside the outer radii and have default values of zero. The DXTRAN photon weight cutoffs have no effect unless the simple physics is used, with one exception: upon leaving the sphere, track weights (regardless of what physics is used) are checked against the cutoffs of the CUT:P card. The DXTRAN weight cutoffs  $DWC$  and  $DWC_2$  are ignored when mesh-based weight windows are used.

The minimum photon weight limit  $DPWT$  on the DXT:N card parallels almost exactly the minimum photon weight entries on the PWT card. One slight difference is that in Russian roulette

during photon production inside DXTRAN spheres, the factor for relating current cell importance to source cell importance is not applied. Thus, the user must have some knowledge of the weight distribution of the DXTRAN particles (from a short run with the DD card, for example) inside the DXTRAN sphere, so the lower weight limit for photon production may be intelligently specified. As in the case of the PWT entries, a negative entry will make the minimum photon weight relative to the source particle starting weight. The default value is zero, which means photon production will occur at each neutron DXTRAN particle collision in a material with nonzero photon production cross section inside the DXTRAN sphere.

DXTRAN can be used in a problem with the  $S(\alpha,\beta)$  thermal treatment, but contributions to the DXTRAN spheres are approximate. DXTRAN should not be used with reflecting surfaces, white boundaries, or periodic boundaries (see page 2–92). DXTRAN is incompatible with a monodirectional source because direct contributions from the source are ignored.

If more than one set of DXTRAN spheres is used in the same problem, they can “talk” to each other in the sense that collisions of DXTRAN particles in one set of spheres cause contributions to another set of spheres. The contributions to the second set have, in general, extremely low weights but can be numerous with an associated large increase in computer time. In this case the DXTRAN weight cutoffs probably will be required to kill the very-low-weight particles. The DD card can give you an indication of the weight distribution of DXTRAN particles.

20. FTn Special Treatments for Tallies

Form:        FTn    ID<sub>1</sub> P<sub>1,1</sub> P<sub>1,2</sub> P<sub>1,3</sub> ... ID<sub>2</sub> P<sub>2,1</sub> P<sub>2,2</sub> P<sub>2,3</sub> ...

*n*        = tally number.

ID<sub>*i*</sub>     = the alphabetic keyword identifier for a special treatment.

FRV     fixed arbitrary reference direction for tally 1 cosine binning.

GEB     Gaussian energy broadening.

TMC     time convolution.

INC     identify the number of collisions.

ICD     identify the cell from which each detector score is made.

SCX     identify the sampled index of a specified source distribution.

SCD     identify which of the specified source distributions was used.

PTT     put different multigroup particle types in different user bins.

ELC     electron current tally.

P<sub>*i,j*</sub>    = parameters for that special treatment, either a number, a parenthesis or a colon.

Default:    If the FT card is absent, there is no special treatment for tally *n*.

Use:        Optional; as needed.

## CHAPTER 3 DATA CARDS

The syntax and meaning of the  $P_{i,j}$  is different for each  $ID_i$ . A special treatment may cause a set of user bins or possibly a set of some other kind of bins to be created. The information in the  $P_{i,j}$  allows the number and kind of those bins to be inferred easily. More than one special treatment can be specified by a given tally except for combinations of INC, ICD, SCX,SCD, PTT and ELC. Only one of these special treatments can be used by a tally at one time because all require user bins, making them mutually exclusive.

A description of the special treatments available follows with an explanation of the allowed parameters for each.

FRV  $V_1$   $V_2$   $V_3$

The  $V_i$  are the xyz components of vector V, not necessarily normalized. If the FRV special treatment is in effect for a type 1 tally, the direction V is used in place of the vector normal to the surface as the reference direction for getting the cosine for binning.

GEB a b c

The parameters specify the full width at half maximum of the observed energy broadening in a physical radiation detector:  $fwhm = a + b\sqrt{E + cE^2}$ , where E is the energy of the particle. The units of a, b, and c are MeV,  $\text{MeV}^{1/2}$ , and none, respectively. The energy actually scored is sampled from the Gaussian with that fwhm. See Chapter 2.

TMC a b

All particles should be started at time zero. The tally scores are made as if the source was actually a square pulse starting at time a and ending at time b.

INC

No parameters follow the keyword but an FUn card is required. Its bin boundaries are the number of collisions that have occurred in the track since the creation of the current type of particle, whether at the source or at a collision where some other type of particle created it. If the INC special treatment is in effect, the call to TALLYX that the presence of the FUn card would normally trigger does not occur. Instead IBU is set by calling JBIN with the number of collisions as the argument.

ICD

No parameters follow the keyword but an FUn card is required. Its bins are the names of some or all of the cells in the problem. If the cell from which a detector score is about to be made is not in the list on the FUn card, the score is not made. TALLYX is not called. The selection of the user bin is done in TALLYD.

SCX k

The parameter *k* is the name of one of the source distributions and is the *k* that appears on the SIK card. One user bin is created for each bin of source distribution *k* plus a total bin. The scores for tally *n* are then binned according to which bin of source distribution *k* the source particle came from. The score of the total bin is the score you would see for tally *n* without the special treatment, if source distribution *k* is not a dependent distribution.

**CAUTION:** For a dependent distribution, the score in the total bin is the subtotal portion of the score from dependent distribution *k*.

### SCD

No parameters follow the keyword but an FUn card is required. Its bins are a list of source distribution numbers from SIK cards. The scores for tally *n* are then binned according to which distribution listed on the FUn card was sampled. This feature might be used to identify which of several source nuclides emitted the source particle. In this case, the source distributions listed on the FUn card would presumably be energy distributions. Each energy distribution is the correct energy distribution for some nuclide known to the user and the probability of that distribution being sampled from is proportional to the activity of that nuclide in the source. The user might want to include an FCn card that tells to what nuclide each energy distribution number corresponds.

**CAUTION:** If more than one of the source distributions listed on the FU card is used for a given history, only the *first* one used will score.

### PTT

No parameters follow the keyword but an FUn card is required. Its bins are a list of atomic weights in units of MeV of particles masquerading as neutrons in a multigroup data library. The scores for tally *n* are then binned according to the particle type as differentiated from the masses in the multigroup data library. For example, .511 0 would be for electrons and photons masquerading as neutrons.

### ELC c

The single parameter *c* of ELC specifies how the charge on an electron is to affect the scoring of an F1 tally. Normally, an electron F1 tally gives particle current without regard for the charges of the particles. There are 3 possible values for *c*:

c=1 to cause negative electrons to make negative scores

c=2 to put positrons and negative electrons into separate user bins

c=3 for the effect of both c=1 and c=2

If c=2 or 3, three user bins, positrons, electrons and total are created.

## F. *Material Specification Cards*

The cards in this section specify the isotopic composition of the materials in the cells and which cross-section evaluations are to be used.

**CHAPTER 3  
DATA CARDS**

<u>Mnemonic</u>	<u>Card Type</u>	<u>Page</u>
Mm	Material	3-108
DRXS	Discrete reaction	3-109
TOTNU	Total fission $\bar{\nu}$	3-110
NONU	Fission turnoff	3-111
AWTAB	Atomic weight	3-112
XSn	Cross-section files	3-112
VOID	Negates materials	3-112
PIKMT	Photon-production bias	3-113
MGOPT	Multigroup card	3-114

1. Mm Material Card

Form: Mm  $ZAID_1$  *fraction*<sub>1</sub>  $ZAID_2$  *fraction*<sub>2</sub> ... keyword=value ...

*m* corresponds to the material number on the cell cards

$ZAID_i$  = either a full ZZZAAA.nnX or partial ZZZAAA element or nuclide identifier for constituent *i*, where ZZZ is the atomic number, AAA is the atomic mass, *nn* is the library identifier, and X is the class of data

*fraction*<sub>*i*</sub> = atomic fraction (or weight fraction if entered as a negative number) of constituent *i* in the material.

keyword = value, where = sign is optional. Keywords are:

GAS = *m* flag for density-effect correction to electron stopping power.  
*m* = 0 calculation appropriate for material in the condensed (solid or liquid) state used.  
*m* = 1 calculation appropriate for material in the gaseous state used.

ESTEP = *n* causes the number of electron substeps per energy step to be increased to *n* for the material. If *n* is smaller than the built-in default found for this material, the entry is ignored. Both the default value and the ESTEP value actually used are printed in Table 85.

NLIB = *id* changes the default neutron table identifier to the string *id*. The neutron default is a blank string, which selects the first matching entry in XSDIR.

PLIB = *id* changes the default photon table identifier to *id*.

ELIB = *id* changes the default electron table identifier to *id*.

COND = *id* sets conduction state of a material only for e103 evaluation.  
 <0 nonconductor  
 =0 (default) nonconductor if at least one nonconducting component; otherwise a conductor  
 >0 conductor if at least one conducting component.

Default: None for ZAID fraction; GAS=0; ESTEP internally set; NLIB, PLIB, and ELIB=first match in XSDIR; COND=0.

Use: Optional, but required if you want materials in cells.

Neutrons. For naturally occurring elements, AAA = 000. Thus, ZAID = 74182.55 represents the isotope  $^{182}\text{W}$  and ZAID = 74000.55 represents the element tungsten. Natural elements not available from among those listed in Appendix G must be constructed on an Mm card by adding together the individual isotopes if they are available. If the density for cells with AAA = 000 is input in  $\text{g/cm}^3$ , MCNP will assume the atomic weight for the natural element. The ZZZ and AAA quantities are determined for neutrons by looking at the list of cross sections in Appendix G and finding the appropriate ZAID associated with an evaluation that you want.

Photons and electrons. If neutrons are not being run, the AAA can be set to 000. Cross sections are specified exactly like the neutron cross sections, but ZZZAAA.nnX equals ZZZ000. There is no distinction between isotope and element for photons and electrons. However, if the isotopic distribution for the element differs from the natural element, the atom density should be entered on the cell cards to ensure the correct atom density for these cells.

Nuclide Fraction. The nuclide fractions can be normalized to 1.0 or left unnormalized. For instance, if the material is  $\text{H}_2\text{O}$  the atom fractions for H and O can be entered as 0.667 and 0.333 or as 2 and 1, respectively. If the fractions are entered with negative signs they are assumed to be weight fractions. Weight fractions and atom fractions cannot be mixed on the same Mm card. There is no limit to the number of “nuclide fraction” entries or the total number of different cross-section tables allowed.

Default Library Hierarchy. When NLIB=*id* is included on an Mm card, the default neutron table identifier for that material is changed to *id*. Fully specifying a ZAID on that Mm card, ZZZAAA.nnX, overrides the NLIB=*id* default.

Example: M1 NLIB=50D 1001 2 8016.50C 1 6012 1

This material consists of three isotopes. Hydrogen (1001) and carbon (6012) are not fully specified and will use the default neutron table that has been defined by the NLIB entry to be 50D, the discrete reaction library. Oxygen (8016.50C) is fully specified and will use the continuous energy library. The same default override hierarchy applies to photon and electron specifications.

## 2. DRXS Discrete Reaction Cross-Section Card

Form: DRXS ZAID<sub>1</sub> ZAID<sub>2</sub> ... ZAID<sub>i</sub> ...  
or blank



## CHAPTER 3 DATA CARDS

$ZAID_i$  = Identifying number of the form ZZAAA.nn, where ZZ is the atomic number, AAA the mass number, and nn the neutron library identifier.

Default: Continuous-energy cross-section treatment if DRXS is absent.

Use: Optional. Applies only to neutron cross sections.

Nuclides listed on the optional DRXS card are given a discrete energy treatment instead of the regular fully continuous-energy cross-section treatment if the necessary discrete data are available. Check the list in Appendix G for availability. If the DRXS card is present but has no entries after the mnemonic, discrete cross sections will be used for every nuclide, if available.

All discrete reaction libraries are based on a 262 energy group structure. Groups below 1 eV make the discrete treatment appropriate for thermal neutron problems near room temperature. All discrete reaction libraries have photon production data given in expanded format.

It is not recommended that this card be used unless you are transporting neutrons in an energy region where resonances and hence self-shielding are of little importance. However, if the problem under consideration meets this criterion, using the DRXS card can reduce computer storage requirements and enhance timesharing.

Use of these discrete cross sections will not result in the calculation being what is commonly referred to as a multigroup Monte Carlo calculation because the only change is that the cross sections are represented in a histogram form rather than a continuous-energy form. The angular treatment used for scattering, energy sampling after scattering, etc., is performed using identical procedures and data as in the continuous-energy treatment. The user wanting to make a truly multigroup Monte Carlo calculation should use the MGOPT card multigroup capability.

### 3. TOTNU Total Fission Card

Form: TOTNU NO  
or blank

Default: If the TOTNU card is absent, prompt  $\bar{\nu}$  is used for non-KCODE calculations and total  $\bar{\nu}$  is used for KCODE calculations.

Use: All steady-state problems should use this card.

In a non-KCODE problem, prompt  $\bar{\nu}$  is used for all fissionable nuclides for which prompt  $\bar{\nu}$  values are available if the TOTNU card is absent. If a TOTNU card is present but has no entry after it, total  $\bar{\nu}$ , sampling both prompt and delayed  $\bar{\nu}$ , will be used for those fissionable nuclides for which

prompt and delayed values are available. A TOTNU card with NO as the entry is the same as if the card were absent, that is, prompt  $\bar{\nu}$  is used.

In a KCODE calculation, total  $\bar{\nu}$ , including both prompt and delayed  $\bar{\nu}$  as available, is used for all fissionable nuclides if the TOTNU card is absent. If a TOTNU card is present but has no entry after it, total  $\bar{\nu}$ , using both prompt and delayed  $\bar{\nu}$ , is again used. A TOTNU card with NO as the entry causes prompt  $\bar{\nu}$  to be used for all fissionable nuclides for which prompt values are available.

The nuclide list of Appendix G indicates data available for each fissionable nuclide. The MCNP neutron cross-section summary print from XACT will show whether prompt or total was used.

#### 4. NONU Fission Turnoff Card

Form:   NONU     $a_1$   $a_2$  ...  $a_i$  ...  $a_{mxa}$   
          or        *blank*

$a_i$    = 0 fission in cell  $i$  treated as capture; gammas produced  
          = 1 fission in cell  $i$  treated as real; gammas produced  
          = 2 fission in cell  $i$  treated as capture; gammas not produced  
 $mxa$  =     number of cells in the problem

Default:   If the NONU card is absent, fission is treated as real fission.

Use:        Optional, as needed.

This card turns off fission in a cell. The fission is then treated as simple capture and is accounted for on the loss side of the problem summary as the "Loss to fission" entry. If the NONU card is not used, all cells are given their regular treatment of real fission, that is, the same as if all entries were one. If the NONU card is present but blank, all  $a_i$ 's are assumed to be zero and fission in all cells is treated like capture. The NONU card cannot be added to a continue-run.

A value of 2 treats fission as capture and, in addition, no fission gamma rays are produced. This option should be used with KCODE fission source problems written to surface source files. Suppressing the creation of new fission neutrons and photons is important because they are already accounted for in the source.

Sometimes it is desirable to run a problem with a fixed source in a multiplying medium. For example, an operating reactor power distribution could be specified as a function of position in the core either by an SDEF source description or by writing the fission source from a KCODE calculation to a WSSA file with a CEL option on an SSW card. The non-KCODE calculation would be impossible to run because of the criticality of the system and because fission neutrons have already been accounted for. Using the NONU card in the non-KCODE mode allows this problem to run correctly by treating fission as simple capture.

## CHAPTER 3 DATA CARDS

### 5. AWTAB Atomic Weight Card

Form:       AWTAB     ZAID<sub>1</sub> AW<sub>1</sub>   ZAID<sub>2</sub> AW<sub>2</sub> ...

ZAID<sub>i</sub>   =   ZAID used on the Mm material card excluding the X for  
                  class of data specification.

AW<sub>i</sub>     =   atomic weight ratios.

Default:    If the AWTAB card is absent, the atomic weight ratios from the cross-section directory file XSDIR and cross-section tables are used.

Use:        Optional, as needed.

Entries on this card override the existing atomic weight ratios as contained in both the cross-section directory file XSDIR and the cross-section tables. The AWTAB card is needed when atomic weights are not available in an XSDIR file. Also, for fission products, ZAID=50120.35, the atomic weight of tin ( $^{120}_{50}\text{Sn}$ ) will be used, so the following AWTAB card is needed:

AWTAB 50120.35 116.490609

**WARNING:** Using atomic weight ratios different from the ones in the cross-section tables in a neutron problem can lead to negative neutron energies that will cause the problem to terminate prematurely.

### 6. XSn Cross-Section File Card

$n$      =   1 to 999

Use:        Optional, as an alternative to the directory part of the XSDIR file.

The XSn card can be used to load cross-section evaluations not listed in the XSDIR file directory. You can use XSn cards in addition to the XSDIR file. Each XSn card describes one cross section table. The entries for the XSn card are identical to those in XSDIR except that the + is not used for continuation. A detailed description of the required entries is provided in Appendix F.

### 7. VOID Material Void Card

Form:       VOID   no entries

or:        VOID   C<sub>1</sub> C<sub>2</sub> ... C<sub>i</sub>

C<sub>i</sub>     =   cell number

Default:    None.

Use:        Debugging geometry and calculating volumes.

The first form is used when calculating volumes stochastically (see page 2–183) and when checking for geometry errors (see page 3–8). When the VOID card is blank, the material number and density is set to zero for all cells, FM cards are turned off, heating tallies are turned into flux tallies, and, if there is no NPS card, the effect of an NPS 100000 card is created. If there is a TALLYX subroutine, it may need to be changed, too.

The second form is used to selectively void cells instead of setting the material number and density to zero by hand on cell cards. It is a convenience if you want to check whether the presence of some object in your geometry makes any significant difference in the answers.

**8. PIKMT Photon–Production Bias Card**

Form: PIKMT     $Z_1$  IPIK<sub>1</sub>    MT<sub>1,1</sub>    PMT<sub>1,1</sub> ... MT<sub>1,IPIK<sub>1</sub></sub>    PMT<sub>1,IPIK<sub>1</sub></sub>  
                    $Z_n$  IPIK<sub>n</sub>    MT<sub>n,1</sub>    PMT<sub>n,1</sub> ... MT<sub>n,IPIK<sub>n</sub></sub>    PMT<sub>n,IPIK<sub>n</sub></sub>

$Z_i$  = the ZAID of the  $i^{\text{th}}$  entry. Full or partial ZAIDs can be specified; that is, 29000 is equivalent to 29000.50.

IPIK <sub>$i$</sub>  = the parameter that controls the biasing for ZAID <sub>$i$</sub> .

0 = no biasing for ZAID <sub>$i$</sub> ; photons from ZAID <sub>$i$</sub>  are produced with the normal sampling technique.

–1 = no photons are produced from ZAID <sub>$i$</sub> .

> 0 = there is biasing for ZAID <sub>$i$</sub> . The value of IPIK <sub>$i$</sub>  is the number of partial photon–production reactions to be sampled.

MT <sub>$i,j$</sub>  and PMT <sub>$i,j$</sub>  are only required for ZAIDs with IPIK <sub>$i$</sub>  > 0, where IPIK <sub>$i$</sub>  pairs of entries of MTs and PMTs are necessary. The MTs are the identifiers for the partial photon–production reactions to be sampled. The PMTs control, to a certain extent, the frequency with which the specified MTs are sampled. The entries need not be normalized. For a ZAID with a positive value of IPIK, any reaction that is not identified with its MT on the PIKMT card will not be sampled.

Default:    If the PIKMT card is absent, there is no biasing of neutron–induced photons. If PIKMT is present, any ZAID not listed has a default value of IPIK <sub>$i$</sub>  = –1.

Use:        Optional; see caveats below.

For several classes of coupled neutron–photon calculations, the desired result is the intensity of a small subset of the entire photon energy spectrum. Two examples are discrete–energy (line) photons and the high–energy tail of a continuum spectrum. In such cases, it may be profitable to bias the spectrum of neutron–induced photons to produce only those that are of interest.

1. **WARNING:** Use of the PIKMT card can cause nonzero probability events to be completely excluded and the biasing game may be not necessarily a fair one. While

## CHAPTER 3 DATA CARDS

neutron tallies will be unaffected (within statistics), the only reliable photon tallies will be those with energy bins immediately around the energies of the discrete photons produced.

2. Users need information about the MT identifiers of the reactions that produce discrete-energy photons. This information is available on the web.
3. The feature is also useful for biasing the neutron-induced photon spectrum to produce very high energy photons (for example,  $E_\gamma \geq 10 \text{ MeV}$ ). Without biasing, these high-energy photons are produced very infrequently; therefore, it is difficult to extract reliable statistical information about them. An energy cutoff can be used to terminate a track when it falls below the energy range of interest. Los Alamos users interested in using the PIKMT card for this application should see X-5 regarding an internal code (NIPE) that is useful for optimizing such problems.

Example: PIKMT 26000.55 1 102001 1 7014 0  
                  29000 2 3001 2 3002 1  
                  8016 -1

This example results in normal sampling of all photon-production reactions for  $^{14}\text{N}$ . All photons from neutron collisions with Fe are from the reaction with MT identifier 102001. Two photon-production reactions with Cu are allowed. Because of the PMT parameters the reaction with MT identifier 3001 is sampled twice as frequently relative to the reaction with MT identifier 3002 than otherwise would be the case. No photons are produced from  $^{16}\text{O}$  or from any other isotopes in the problem that are not listed on the PIKMT card.

### 9. MGOPT Multigroup Adjoint Transport Option

Form: MGOPT MCAL IGM IPLT ISB ICW FNW RIM

MCAL = F for forward problem  
      A for adjoint problem

IGM = the total number of energy groups for all kinds of particles in the problem. A negative total indicates a special electron-photon problem.

IPLT = indicator of how weight windows are to be used.  
      = 0 means that IMP values set cell importances. Weight windows, if any, are ignored for cell importance splitting and Russian roulette.  
      = 1 means that weight windows must be provided and are transformed into energy-dependent cell importances. A zero weight-window lower bound produces an importance equal to the lowest nonzero importance for that energy group.  
      = 2 means that weight-windows do what they normally do.

ISB = Controls adjoint biasing for adjoint problems only (MCAL=A).

- = 0 means collisions are biased by infinite-medium fluxes.
- = 1 means collisions are biased by functions derived from weight-windows, which must be supplied.
- = 2 means collisions are not biased.
- ICW = name of the reference cell for generated weight windows.
- = 0 means weight windows are not generated.
- ≠ 0 requires volumes be supplied or calculated for all cells of nonzero importance.
- FNW = normalization value for generated weight windows. The value of the weight-window lower bound in the most important energy group in cell ICW is set to FNW.
- RIM = compression limit for generated weight windows. Before generated weight windows are printed out, the weight windows in each group separately are checked to see that the ratio of the highest to the lowest is less than RIM. If not, they are compressed.

Default: IPLT=0, ISB=0, ICW=0, FNW=1, RIM=1000. MCAL and IGM must be specified.

Use: Required for multigroup calculation.

MCAL and IGM are required parameters. The others are optional. "J" is not an acceptable value for any of the parameters.

At this time, the standard MCNP multigroup neutron cross sections are given in 30 groups and photons are given in 12 groups. Thus, an existing continuous-energy input file can be converted to a multigroup input file simply by adding one of the following cards:

```

MGOPT F 30 $MODE N
MGOPT F 42 $MODE N P
MGOPT F 12 $MODE P

```

A negative IGM value allows a single cross-section table to include data for more than one sort of particle. This feature applies currently to electron/photon multigroup calculations only. A problem with 50 electron groups followed by 30 photon groups in one table would have IGM=-80. Also all tables must have the same group structure. A negative IGM value will use the energy variable on the source or tally card as a group index unless it is associated with a distribution. For an energy distribution on the source card, there should be IGM increasing integer entries for each group on the SI card. On a tally energy card, if there are less than IGM entries, they will be taken as energies in MeV; otherwise, the bins will be according to group index. The particles can be separated in tallies by using the PTT option on the FTn tally card.

## CHAPTER 3 DATA CARDS

An input file for an adjoint problem can have both an IMP card and weight window cards (IPLT=0 ISB=1). The entries on the weight window cards are not weight windows in the normal sense but biasing functions. If IPLT=1 the values on a weight window card become energy-dependent cell importances. Until now, importances have been energy independent.

See Appendix G for a more complete discussion of multigroup libraries.

### *G. Energy and Thermal Treatment Specification*

The following cards control energy and other physics aspects of MCNP. All energies are in units of MeV and all times are in shakes

<u>Mnemonic</u>	<u>Card Type</u>	<u>Page</u>
PHYS	Energy physics cutoff	3-103
TMP	Free-gas thermal temperature	3-108
THTME	Thermal times	3-108
MTm	$S(\alpha,\beta)$ material	3-109

#### 1. PHYS Energy Physics Cutoff Card

##### a) Neutrons

Form:      PHYS:N    EMAX   EMCNF   IUNR   DNB

EMAX    = upper limit for neutron energy, MeV.

EMCNF   = energy boundary above which neutrons are treated with implicit capture and below which they are treated with analog capture.

IUNR    = 0/1 = on/off unresolved resonance range probability tables.

DNB     = number of delayed neutrons produced from fission

          -1/0/>0 = natural sampling/no delayed neutrons produced/DNB  
          delayed neutrons per fission.

          DNB > 0 not allowed in KCODE calculation.

Default:    EMAX = very large; EMCNF = 0.0 MeV; IUNR = 0; DNB = -1

Use:        Optional.

EMAX is the upper limit for neutron energy. All neutron cross-section data above EMAX are expunged. If EMAX is not specified, there is no upper energy expunging of cross-section data to save computer storage space. The physics of MCNP is such that if a neutron energy is greater than the maximum energy in a table (typically 20 MeV), the cross section for the maximum energy is

used with no extrapolation. If a particle is born above EMAX, either by source or collision, it is rejected and the particle energy is resampled.

EMCNF controls the type of capture. Any neutron with energy greater than EMCNF will receive the implicit capture treatment; below EMCNF, it will receive analog capture. This parameter is analogous to EMCPF on the PHYS:P card and is useful in eliminating low-energy histories when using a thermal treatment. Substantial computer time may be saved in a region of low absorption (especially if the region is heterogeneous and bounded by a reflecting surface) simply by reducing the number of tracks. EMCNF should be set to operate when a neutron enters a thermal regime, typically a few kT. However, analog capture may undesirably kill important particles before they are tallied or before they participate in physics important to the problem.

If EMCNF = EMAX, analog capture is used regardless of the value of WC1 on the CUT card. If WC1 = 0, analog capture is used regardless of the value of EMCNF.

IUNR controls the treatment of cross sections in the unresolved energy range. The probability table treatment (IUNR=0) should be left on for better physics but can be turned off (IUNR=1) to measure the effect of the probability table treatment or to speed calculations when unresolved resonances are unimportant.

DNB controls the number of delayed neutrons produced from fission and can be used only when TOTNU is specified for fissionable nuclides for which delayed and prompt  $\nu$  values are available. If DNB is not specified, the number of delayed neutrons produced per fission is determined from the ratio of delayed  $\nu$  to total  $\nu$ . The nuclide list of Appendix G indicates data available for each fissionable nuclide.

b) Photons

Form:        PHYS:P        EMCPF   IDES   NOCOH

EMCPF = upper energy limit for detailed photon physics treatment, MeV.

IDES = 0 photons will produce electrons in MODE E problems or bremsstrahlung photons with the thick target bremsstrahlung model.

= 1 photons will not produce electrons as above.

NOCOH = 0 coherent scattering occurs.

= 1 coherent scattering will not occur.

Default:    EMCPF = 100 MeV;   IDES = 0;   NOCOH = 0.

Use:        Optional.

Photons with energy greater than EMCPF will be tracked using the simple physics treatment. If WC1 = 0 on the CUT:P card, analog capture is used in the energy region above EMCPF. Otherwise



## CHAPTER 3 DATA CARDS

capture is simulated by weight reduction with Russian roulette on weight cutoff. Photons with energy less than EMCPF will be treated with the more detailed physics that always includes analog capture. For a detailed discussion of the simple and detailed photon physics treatments, see Chapter 2.

The simple physics treatment, intended primarily for higher energy photons, considers the following physical processes: photoelectric effect without fluorescence, Compton scattering from free electrons without the use of form factors, and pair production. The highly forward peaked coherent Thomson scattering is ignored.

In the detailed physics treatment, photoelectric absorption can result in fluorescent emission, the Thomson and Klein-Nishina differential cross sections are modified by appropriate form factors taking electron binding effects into account, and coherent scattering is included.

To turn off the production of secondary electrons generated by photons, the switch IDES can be set, either on the PHYS:P or on the PHYS:E card. If either of these cards sets IDES = 1, photons will NOT produce electrons, even if IDES = 0 is set on the other. In a photon-only problem, turning off secondary electrons causes the thick-target bremsstrahlung model to be bypassed. This option should be exercised only with great care because it alters the physics of the electron-photon cascade and will give erroneously low photon results when bremsstrahlung and electron transport are significant.

NOCOH is a switch to allow coherent scattering to be turned off for photons with energies below EMCPF. Thus, coherent scattering can be suppressed within the detailed physics treatment without losing the other advantages of the detailed model. When NOCOH = 1, the cross section for coherent scattering will be set to zero. This approximation can be useful in problems with bad point detector variances.

### c) Electrons

Form: PHYS:E EMAX IDES IPHOT IBAD ISTRG BNUM XNUM RNOK ENUM  
NUMB

EMAX	=	upper limit for electron energy in MeV.
IDES	=	0/1 = photons will/will not produce electrons.
IPHOT	=	0/1 = electrons will/will not produce photons.
IBAD	=	0 full bremsstrahlung tabular angular distribution.
	=	1 simple bremsstrahlung angular distribution approximation.
ISTRG	=	0 sampled straggling for electron energy loss.
	=	1 expected-value straggling for electron energy loss.
BNUM	<	0 only applicable for eI03 evaluation. See below for details.
	=	0 bremsstrahlung photons will not be produced
	>	0 produce BNUM times the analog number of bremsstrahlung

- photons. Radiative energy loss uses the bremsstrahlung energy of the first sampled photon.
- XNUM > 0 produce XNUM times the analog number of electron-induced x-rays.  
 = 0 x-ray photons will not be produced by electrons.
- RNOK > 0 produce RNOK times the analog number of knock-on electrons.  
 = 0 knock-on electrons will not be produced.
- ENUM > 0 produce ENUM times the analog number of photon-induced secondary electrons.  
 = 0 photon-induced secondary electrons will not be produced.
- NUMB > 0 produce bremsstrahlung on each substep  
 = 0 nominal bremsstrahlung production

Defaults: EMAX = 100 MeV; IDES, IPHOT, IBAD, ISTRG = 0;  
 BNUM, XNUM, RNOK, ENUM = 1., NUMB = 0

Use: Optional.

EMAX is the upper electron energy limit in MeV. Electron cross sections and related data are generated on a logarithmic energy grid from EMAX down to an energy at least as low as the global energy cutoff for electrons. Setting the value of EMAX too high results in longer processing times and larger storage requirements for electron data. EMAX should be set to the highest electron energy encountered in your problem.

IDES is a switch to turn off electron production by photons. The default (IDES = 0) is for photons to create electrons in all photon-electron problems and for photons to produce bremsstrahlung photons using the thick-target bremsstrahlung approximation in photon problems run without electrons. In either case the electron default cross section library will be read, which requires considerable processing time. Electron transport is also very slow. However, the neglect of electron transport and bremsstrahlung production will cause erroneously low photon results when these effects are important. IDES = 1 turns off electron production, but it does not turn off the pair production--produced annihilation photons. See ENUM.

IPHOT is a switch to turn off photon production by electrons. Because photon transport is fast relative to electron transport and is usually required for an accurate physical model, the default (IPHOT = 0, which leaves photon production on) is recommended.

IBAD is a switch to turn on the simple approximate bremsstrahlung angular distribution treatment and turn off the full, more detailed model. The electron transport random walk can be done with either the simple or full treatment, but photon contributions to detectors and DXTRAN can use only the simple treatment. The full detailed physics model is more accurate and just as fast as the simple approximate treatment for the electron transport random walk, and is therefore the default

## CHAPTER 3

### DATA CARDS

(IBAD = 0) even though it is inconsistent with the way bremsstrahlung photons contribute to detectors and DXTRAN spheres. Setting IBAD = 1 causes the simple treatment to be used for detectors and DXTRAN and the electron random walk, which is self-consistent.

ISTRG is a switch to control the electron continuous-energy slowing down treatment. If ISTRG = 1, the expected value for each collision is used; if ISTRG = 0 (default), the more realistic sampled value is used. The option of using the expected value is useful for some comparisons to deterministic electron transport calculations.

BNUM, XNUM, RNOK, and ENUM are biasing parameters for specific classes of electron or photon production processes. For each parameter the default is 1.0, which invokes an analog treatment for the associated process. Other values allow biasing of the sampling of the processes. The processes associated with the four parameters follow.

BNUM is used to control the sampling of bremsstrahlung photons produced along electron substeps. The default value (BNUM = 1) results in the analog number of bremsstrahlung tracks being sampled. If BNUM > 0, the number of bremsstrahlung photons produced is BNUM times the number that would be produced in the analog case. If the number of tracks is increased, an appropriate weight reduction is made; if the biasing reduces the number of tracks, the weight is increased. If BNUM = 0, the production of bremsstrahlung photons is turned off. In the el1 treatment, BNUM > 0 produces BNUM times the number of analog identical photons with appropriately modified weights. In the el03 treatment, BNUM > 0 produces BNUM times the number of analog photons, each sampled independently for energy and angle with appropriately modified weights. Such a scheme is similar to the one used in ITS3.0 and recommended by Bielajew, et. al. (A. F. Bielajew, R. Mohan, and C. S. Chui, "Improved Bremsstrahlung Photon Angular Sampling in the EGS4 Code System," Nov. 1989, PIR-0203.) In either case radiative energy loss uses the bremsstrahlung energy of the first sampled photon. BNUM < 0 (only for el03) produces |BNUM| times the number of analog photons, each sampled independently for energy and angle with appropriately modified weights. However, the radiative energy loss uses the average energy of all the bremsstrahlung photons sampled. Such a scheme conserves energy more closely but becomes more like a continuous slowing down approximation energy loss model.

XNUM is used to control the sampling of x-ray photons produced along electron substeps. The default value (XNUM = 1) results in the analog number of tracks being sampled. If XNUM > 0, the number of photons produced is XNUM times the number that would be produced in the analog case, and an appropriate weight adjustment is made. If XNUM = 0, the production of x-ray photons by electrons is turned off.

RNOK is used to control the number of knock-on electrons produced in electron interactions. The default value (RNOK = 1) results in the analog number of tracks being sampled. If RNOK > 0, the number of knock-on electrons produced is RNOK times the analog number, and an appropriate weight adjustment is made. If RNOK = 0, the production of knock-on electrons is turned off.

ENUM is used to control the generation of photon-induced secondary electrons. The default value (ENUM = 1) results in an analog treatment. If ENUM > 0, ENUM times the analog number of secondaries will be produced, and an appropriate weight adjustment is made. If ENUM = 0, the generation of secondary electrons by photons will be turned off. ENUM = 0 differs from IDES = 1. If ENUM = 0, pair production is totally turned off. If IDES = 1, the pair production-produced annihilation photons are still produced.

NUMB generates bremsstrahlung on each electron substep. Only a real event, one that has been sampled to have a bremsstrahlung interaction, causes energy loss. The weights of the bremsstrahlung photons are multiplied by the probability of interaction in a substep. If two or more photons are produced in a real event, the weight of the second or more photons is the unadjusted value because there is no Poisson sampling, except for real events.

In any of these biasing schemes, increasing the population of photons also increases the population of electrons because the additional photon tracks create photoelectrons, Compton recoil electrons, pair production electrons, etc. Similarly, increasing the number of electrons will propagate an increase in the population of subsequent generations of the cascade. Because electron transport is slow, a judicious use of ENUM < 1 may often be appropriate. When BNUM is set by the user, ENUM=1/BNUM in the el03 treatment unless the user sets ENUM. When NUMB>0, ENUM=1% by default.

The use of the switches, or of zero values for the biasing parameters, to turn off various processes goes beyond biasing, and actually changes the physics of the simulation. Therefore such actions should be taken with extreme care. These options are provided primarily for purposes of debugging, code development, and special-purpose studies of the cascade transport process.

## 2. TMP Free-Gas Thermal Temperature Card

Form:        TMPn  $T_{1n} T_{2n} \dots T_{in} \dots T_{In}$   
 $n$         = index of time on the THTME card.  
 $T_{in}$      = temperature of  $i^{\text{th}}$  cell at time  $n$ , in MeV.  
 $I$         = number of cells in the problem.

Default:     $2.53 \times 10^{-8}$  MeV, room temperature.

Use:        Optional. Required when THTME card is used. Needed for low-energy neutron transport at other than room temperature. A fatal error occurs if a zero temperature is specified for a nonvoid cell.

The TMP cards provide MCNP the time-dependent thermal cell temperatures that are necessary for the free-gas thermal treatment of low-energy neutron transport described on page 2–28. This treatment becomes important when the neutron energy is less than about 4 times the temperature

## CHAPTER 3 DATA CARDS

of heavy nuclei or less than about 400 times the temperature of light nuclei. Thus the TMP cards should be used when parts of the problem are not at room temperature and neutrons are transported with energies within a factor of 400 from the thermal temperature.

Thermal temperatures are entered as a function of time with a maximum of 99 time entries allowed. These times are entered on a thermal time (THTME) card. The thermal temperatures at time  $t_{1n}$  are listed, cell by cell, on the TMP1 card; the cell thermal temperatures at time  $t_{2n}$  are listed on the TMP2 card, etc. A linear interpolation is used to determine the cell thermal temperatures at times between two entries. Time values before  $t_{1n}$  or after  $t_{1n}$  use the thermal temperatures at the nearest time entry.

We use  $kT$  to denote the thermal temperature of a cell and use units of MeV. The following formulas can be used to provide the values of  $kT$  for temperatures in degrees Kelvin, Celsius, Rankine, and Fahrenheit.

$$\begin{aligned}kT(\text{MeV}) &= 8.617 \times 10^{-11}T \text{ where } T \text{ is in degrees } K \\ &= 8.617 \times 10^{-11}(T + 273.15) \text{ where } T \text{ is in degrees } C \\ &= 4.787 \times 10^{-11}T \text{ where } T \text{ is in degrees } R \\ &= 4.787 \times 10^{-11}(T + 459.67) \text{ where } T \text{ is in degrees } F\end{aligned}$$

### 3. THTME Thermal Times Card

Form:       THTME     $t_1 t_2 \dots t_n \dots t_N$   
 $t_n$     =    time in shakes at which thermal temperatures are specified on  
                  the TMP card.  
 $N$        =    total number of thermal times specified.  
Default:       Zero; temperature is not time dependent.  
Use:            Optional. Use with TMP card.

The THTME card specifies the times at which the thermal temperatures on the TMPn cards are provided. The temperatures on the TMP1 card are at time  $t_1$  on the THTME card, the temperatures on the TMP2 card are at time  $t_2$  on the THTME card, etc. The times must be monotonically increasing:  $t_n < t_{n+1}$ . For each entry on the THTME card there must be a TMPn card.

### 4. MTm $S(\alpha,\beta)$ Material Card

Form:       MTm     $X_1 X_2 \dots$   
 $X_i$     =     $S(\alpha,\beta)$  identifier corresponding to a particular component on the  
                  Mm card.  
Default:       None.  
Use:            Optional, as needed.

For any material defined on an Mn card, a particular component of that material (represented by a ZAID number) can be associated through an MTm card with an  $S(\alpha,\beta)$  data set if that data set exists. The  $S(\alpha,\beta)$  data for that ZAID are used in every cell in which that material is specified. For a particular ZAID in a material, the free-gas treatment can be used down to the energy where  $S(\alpha,\beta)$  data are available. At that point, the  $S(\alpha,\beta)$  treatment automatically overrides the free-gas treatment (that is, there is no mixing of the two treatments for the same ZAID in the same material at a given energy). Typically the free-gas model is used for a particular ZAID of a material down to 4 eV and then the  $S(\alpha,\beta)$  treatment will take over. In general,  $S(\alpha,\beta)$  effects are most significant below 2 eV.

The  $S(\alpha,\beta)$  treatment is invoked by identifiers on MTm cards. The  $m$  refers to the material  $m$  defined on a regular Mm card. The appearance of an MTm card will cause the loading of the corresponding  $S(\alpha,\beta)$  data from the thermal data file. The currently available  $S(\alpha,\beta)$  identifiers for the MTm card are listed in Table G.1 of Appendix G.  $S(\alpha,\beta)$  contributions to detectors or DXTRAN spheres are approximate.

Examples:	M1	1001 2	8016 1	\$ light water
	MT1	LWTR.07		
	M14	1001 2	6012 1	\$ polyethylene
	MT14	POLY.03		
	M8	6012 1		\$ graphite
	MT8	GRPH.01		

### H. Problem Cutoff Cards

The following cards can be used in an initiate-run or a continue-run input file to specify parameters for some of the ways to terminate tracks in MCNP.

<u>Mnemonic</u>	<u>Card Type</u>	<u>Page</u>
CUT	Cutoffs	3-123
ELPT	Cell-by-cell energy cutoff	3-125
NPS	History cutoff	3-125
CTME	Computer time cutoff	3-126

#### 1. CUT Cutoffs Card

Form:      CUT:n            *T E WC1 WC2 SWTM*

*n*        = *N* for neutrons, *P* for photons, *E* for electrons.  
*T*        = time cutoff in shakes, 1 shake= $10^{-8}$  sec.  
*E*        = lower energy cutoff in MeV.  
*WC1* and *WC2* = weight cutoffs.

## CHAPTER 3 DATA CARDS

$SWTM$  = minimum source weight.

Use: Optional, as needed.

Neutron default:  $T$ =very large,  $E=0.0$  MeV,  $WC1 = -0.50$ ,  $WC2 = -0.25$ ,  
 $SWTM$ =minimum source weight if the general source is used.

If a neutron's time becomes greater than  $T$ , its transport is stopped and it is killed. Even though MCNP is time dependent, neutron decay is not considered. Any neutron with energy lower than  $E$  is killed.

If a neutron's weight  $WGT$  falls below  $WC2$  times the ratio  $R$  of the source cell importance to the current cell importance, then with probability  $WGT/(WC1 * R)$ , the neutron survives and is assigned  $WGT = WC1 * R$ . If negative values are entered for the weight cutoffs, the values

$$|WC1| * W_s \text{ and } |WC2| * W_s$$

will be used for  $WC1$  and  $WC2$ , respectively, where  $W_s$  is the minimum weight assigned to a source neutron from an MCNP general source. These negative entries are recommended for most problems. If only  $WC1$  is specified, then  $WC2 = 0.5 * WC1$ . See page 2-139 for a discussion of weight cutoffs.

In a coupled neutron/photon problem, photons are generated before the neutron weight cutoff game is played.

If  $WC1$  is set to zero, capture is treated explicitly by analog rather than implicitly by reducing the neutrons's weight according to the capture probability. If  $EMCNF = E_{max}$  on the PHYS card, analog capture is used regardless of the value of  $WC1$  except for neutrons leaving a DXTRAN sphere.

$SWTM$  (source weight minimum) can be used to make the weight cutoffs relative to the minimum starting weight of a source particle for user source as is done automatically for the general source. The entry will in general be the minimum starting weight of all source particles, including the effects of energy and direction biasing. The entry is also effective for the general source as well. Then  $SWTM$  is multiplied by the W entry on the SDEF card but is unaffected by any directional or energy biasing. This entry is ignored for a KCODE calculation.

Photon default:  $T$ =neutron cutoff,  $E=0.001$  MeV,  $WC1 = -0.50$ ,  $WC2 = -0.25$ ,  
 $SWTM$ =minimum source weight if the general source is used.  
If there are pulse height tallies,  $WC1 = WC2 = 0$ .

The CUT:P weight cutoffs are analogous to the CUT:N card except that they are used only for energies above the EMCPF entry on the PHYS:P card (see page 3-117). If  $WC1=0$ , analog capture is specified for photons of energy greater than EMCPF, just as it is for neutrons. For energies below EMCPF, analog capture is the only choice with one exception: photons leaving a DXTRAN

sphere. Their weight is always checked against the CUT:P weight cutoff upon exiting. If only *WC1* is specified, then  $WC2 = 0.5 * WC1$ .

In a coupled neutron/photon problem, the photon weight cutoffs are the same as the neutron weight cutoffs unless overridden by a CUT:P card. Again, the photon weight cutoffs have no effect at energies below EMPCF (except with DXTRAN as noted above).

MCNP allows only analog capture below 0.001 MeV. Because the photoelectric cross section is virtually 100% of the total cross section below that energy for all isotopes, tracks will be quickly captured and terminated.

Electron default:  $T$ =neutron cutoff,  $E=0.001$  MeV,  $WC1 = 0$ ,  $WC2 = 0$ ,  
 $SWTM$ =minimum source weight if the general source is used.

The CUT:E weight cutoff entries have the same meaning as the neutron entries have.

## 2. ELPT Cell-by-cell Energy Cutoff

Form: ELPT:n  $x_1$   $x_2$  ...  $x_i$  ...  $x_I$

$n$  =  $N$  for neutrons,  $P$  for photons,  $E$  for electrons.  
 $x_i$  = lower energy cutoff of cell  $i$   
 $I$  = number of cells in the problem.

A separate lower energy cutoff can be specified for each cell in the problem. The higher of either the value on the ELPT:n card or the global value  $E$  on the CUT:n card applies.

## 3. NPS History Cutoff Card

Form: NPS N

$N$  = number of particle histories.

Default: None.

Use: As needed to terminate the calculation. In a criticality calculation, the NPS card has no meaning and a warning error message is issued if it is used.

The single entry  $N$  on this card is used to terminate the Monte Carlo calculation after  $N$  histories have been transported—unless the calculation is terminated earlier for some other reason such as computer time cutoff.



## CHAPTER 3 DATA CARDS

In a continue-run, NPS is the total number of particles including runs before the continue-run; it is cumulative. However, a negative NPS entry means to print an output file at the time of the last history run and then stop.

In a surface source problem, either more or less than all of the particle histories on the RSSA surface source file will be run, depending on the value  $N$  entered on the NPS card. If  $N < NPI$ , where  $NPI$  is the number of original histories, Russian roulette with weight adjustment will be played with each history in the file, using a survival probability of  $N/NPI$ . If  $N > NPI$ , the histories will be split  $N/NPI$  to 1, and the fractional part is taken care of by sampling. This can be done equally well for nonspherical sources by cell importance splitting. With a spherical source, each multiple occurrence of the history is sampled for a different starting location on the source sphere, possibly improving the spatial statistics of the results. In either case, the use of the NPS card will not provide additional information about the original source distributions or the transport to the recording surface crossing.

### 4. CTME Computer Time Cutoff Card

Form: CTME  $x$

$x$  = maximum amount of computer time (in minutes) to be spent in the Monte Carlo calculation.

Default: None.

Use: As needed.

For a continue-run job the time on the CTME card is the time relative to the start of the continue-run; it is not cumulative.

Five normal ways to terminate an MCNP calculation are the NPS card, the CTME card, the job time limit, the end of a surface source file, and the number of cycles on a KCODE card. If more than one is in effect, the one encountered first will control. MCNP checks the computer time remaining in a running problem and will terminate the job itself, leaving enough time to wrap up and terminate gracefully.

### I. *User Data Arrays*

Two arrays, IDUM and RDUM, are in MCNP variable COMMON and are available to the user. They are included in the dumps on the RUNTPE file and can therefore be used for any purpose, including accumulating information over the entire course of a problem through several continue-runs. Each array is dimensioned 50, and they can be filled by cards in the input file. IDUM is an integer array and RDUM is a floating point array.

1. IDUM Integer Array Card

Form: IDUM  $I_1 \dots I_n$ ,  $1 \leq n \leq 50$

Default: All array values zero.

Use: Useful only in user-modified versions of MCNP.

Entries (up to 50) fill the IDUM array with integer numbers. If floating point numbers are entered, they will be truncated and converted to integers.

2. RDUM Floating Point Array Card

Form: RDUM  $R_1 \dots R_n$ ,  $1 \leq n \leq 50$

Default: All array values zero.

Use: Useful only in user-modified versions of MCNP.

Entries (up to 50) fill the RDUM array with floating point numbers.

**J. *Peripheral Cards***

The following cards offer a variety of conveniences:

<u>Mnemonic</u>	<u>Card Type</u>	<u>Page</u>
PRDMP	Print and dump cycle	3-127
LOST	Lost particle	3-129
DBCN	Debug information	3-129
FILES	Create user files	3-133
PRINT	Printing control	3-134
MPLOT	Plot tally while problem is running	3-136
PTRAC	Particle track output card	3-137
PERT	Perturbation Card	3-141

1. PRDMP Print and Dump Cycle Card

Form: PRDMP NDP NDM MCT NDMP DMMP

NDP = increment for printing tallies

NDM = increment for dumping to RUNTPE file

MCT = flag to write MCTAL file and for OUTP comparisons

## CHAPTER 3 DATA CARDS

NDMP =	maximum number of dumps on RUNTPE file	
DMMP	<u>Sequential</u> MCNP	<u>Multiprocessing</u> MCNP
	TFC entries every	TFC entries and rendezvous every
	< 0	1000 particles
	= 0	1000 particles
		10 during the run (see discussion below)
	> 0	DMMP particles

Default: Print only after the calculation has successfully ended. Dump every 15 minutes and at the end of the problem. Do not write a MCTAL file. Write all dumps to the RUNTPE file. DMMP=0 (see table above).

Use: Recommended, especially for complex problems.

The PRDMP card allows the user to control the interval at which tallies are printed to the OUTP file and information is dumped to the RUNTPE file. Positive entries mean that after every NDP histories the summary and tallies are printed to the output file, and after every NDM histories a dump is written to the run file. A negative entry changes the unit from histories to minutes of computer time. In a criticality calculation, positive entries for NDP and NDM on the PRDMP card are interpreted as the number of cycles rather than the number of particles started. Printing and dumping are done only at the ends of cycles.

If the third entry MCT on the PRDMP card is nonzero, a MCTAL file is written at the problem end. The MCTAL file is an ASCII file of tallies that can be subsequently plotted with the MCNP MC PLOT option (see description elsewhere). The MCTAL file is also a convenient way to store tally information in a format that is stable for use in the user's own auxiliary programs. For example, if the user is on a system that cannot use the MCNP MC PLOT option, the MCTAL file can be manipulated into whatever format is required by the user's own local plotting algorithms. If MCT=-1, references to code name, version number, problem ID, figure of merit, and anything else having to do with running time are omitted from MCTAL and OUTP so that tracking runs (identical random walks) yield identical MCTAL and OUTP files. MCT=-2 turns off additional prints in OUTP to assist in comparing multitasking output.

The PRDMP card also allows the user to control the size of the RUNTPE file by specifying the maximum number of dumps, NDMP, to be written. The RUNTPE file will contain the last NDMPs that were written. For example, if NDMP = 4, after dump 20 is written only dumps 17, 18, 19, and 20 will be on the RUNTPE file. In all cases, the fixed data and cross section data at the front of the RUNTPE file are preserved.

The fifth entry DMMP has several possible meanings. For sequential MCNP, a value of DMMP  $\leq 0$  results in TFC entries every 1000 particles initially. This value doubles to 2000 after



## CHAPTER 3 DATA CARDS

		calculations;
$X_8$	=	number of the history whose starting pseudorandom number is to be used to start the first history of this problem;
$X_9$	=	closeness of coincident repeated structures surfaces. Default = 1.E-4;
$X_{10}$	=	seconds between time interrupts. Default = 100 seconds;
$X_{11}$	=	1 causes collision lines to print in lost particle event log;
$X_{12}$	=	expected number of random numbers;
$X_{13}$	=	random number stride. Default = 152917;
$X_{14}$	=	random number multiplier. Default = $5^{19}$ ;
$X_{15}$	=	1 prints the shifted confidence interval and the variance of the variance for all tally bins;
$X_{16}$	=	scale the score grid for the accumulation of the empirical $f(x)$ in print tables 161 and 162;
$X_{17}$	=	0 default angular treatment for partial substeps to generation sites of secondary particles; > 0 alternate angular treatment for secondary generation; < 0 MCNP4A treatment of electron angles at secondary generation sites;
$X_{18}$	=	0 default "MCNP-style" energy indexing algorithm; 1 "ITS-style" energy indexing algorithm;
$X_{20}$	=	track previous version.

Use:       Optional.

The entries on this card are used primarily for debugging problems and the code itself. The first 12 can be changed in a continue run which is useful for diagnosing troubles that occur late in a long-running problem.

1.  $X_1$  is the random number used for starting the transport of the first particle history in a run. See also entry  $X_8$ , which for repeating particle histories, is the preferred method of changing the pseudorandom number sequence. See the **caution** after the last DBCN item listed below.
2.  $X_2$  is used to print out information about every  $X_2$ th particle. The information consists of: (a) the particle history number, (b) the total number of neutron, photon, and electron collisions, (c) the total number of random numbers generated, and (d) the random number at the beginning of the history. This information is printed at the beginning of the history and is preceded by the letters DBCN in the output to aid in a pattern search.
3. and 4. Event log printing is done for histories  $X_3$  through  $X_4$ , inclusively. The information includes a step-by-step account of each history, such as where and how a particle is born, which surface it crosses and which cell it enters, what happens to it in a cell, etc. See  $X_{11}$ .

5.  $X_5$  is the maximum number of events the event log will print per history. The default is 600.
6. Unused.
7.  $X_7 = 1$  will cause a detailed print from the volume and surface area calculations and is useful only to MCNP code developers.
8. The  $X_8$ th entry causes the starting random number of the problem to be the random number that would normally be picked for the  $X_8$ th history. If a surface source is used, the  $X_8$ th surface source history will be taken from the RSSA file at the problem start. The purpose of this entry is to let the  $X_8$ th history be the first history of a problem for debugging purposes or to select a random number sequence different from that in an identical problem to compare statistical convergence. See the **caution** after the last DBCN item listed below.
9.  $X_9$  defines the distance allowed between coincident repeated structures surfaces for them still to be considered coincident. The default is 1.E-4. A value of 1.E-30 reproduces the earlier treatment where coincident repeated structures surfaces was not allowed.  $X_9$  should not have to be changed unless geometries have dimensions greater than 1.E5 or unless surfaces at different levels are intended to be closer than 2.E-4.
10.  $X_{10}$  is the seconds between time interrupts for checking if a history has run too long or is in an infinite loop. The default is 100 seconds. If in two consecutive time interrupts the random walk is in the same history, MCNP assumes that something is wrong and stops the job. If histories should legitimately take longer than  $X_{10}$  seconds the job can be continued with a larger value for  $X_{10}$  specified on the DBCN card in the continue-run INP file. This entry also affects the time increment MCNP reserves for itself to terminate a job before the job time limit is reached. The increment for interactive jobs is  $2X_{10}$  or 1% of the time limit, whichever is greater.
11.  $X_{11} = 1$  causes collision lines to print in the lost particle event log.
12.  $X_{12}$  is the expected number of random numbers for this calculation. Entering  $X_{12}$  will cause the last line of the output file to print  $X_{12}$  and the actual number of random numbers used so that a quick comparison can be made to see if two problems tracked each other.
13.  $X_{13}$  is the random number stride, S. The default is  $S = X_{13} = 152917$ . Each source history starts with a random number S numbers up the pseudorandom number sequence from the random number of the previous history. If any history requires more than S random numbers, the number of times S was exceeded is printed in the problem summary of the OUTP file. The maximum number of random numbers required for a history is always printed in the problem summary. Exceeding the random number stride will cause a correlation between histories and should be avoided because variances may be underestimated. However, if the stride is too large, the period of the random number sequence,  $2^{46} \approx 7.04 \text{ E}13$ , will be exceeded.

## CHAPTER 3 DATA CARDS

- S should be chosen so that  $NPS * S < 2^{46}$ . Exceeding the period will underestimate variances, particularly if S is a power of 2.
14.  $X_{14}$  is the random number multiplier. The default is  $X_{14} = 5^{19} = 19073486328125$ , which is adequate for all known problems. If a new entry is such that the sum of its left and right 24-bit halves is not less than  $2^{24}$  then the input value is rejected. If  $X_{14}$  is even it is rejected because the random number sequence rapidly converges to zero.
  15. A nonzero  $X_{15}$ th entry causes the shifted confidence interval and the variance of the variance (VOV) to be calculated and printed for all tally bins. An extra line of tally output is created for each tally that contains nonzero information. The shifted confidence interval center is followed by the estimated VOV. If the tally mean and relative error (RE) are all zeros, the VOV line is not printed because it is all zero also. Changing  $X_{15}$  from nonzero to zero in a CONTINUE run will cause the VOV information not to be printed.  $X_{15}$  cannot be changed from zero to nonzero in a CONTINUE run.
  16. MCNP uses a logarithmically spaced history score grid in print table 161 for  $f(x)$ , producing a straight line for  $f(x)$  on a log-log plot for  $1/x^n$  behavior, covering 60 decades of unnormalized tally magnitudes from  $1E-30$  to  $1E30$ . This range can be multiplied by the  $X_{16}$ th entry when the range is not sufficient. A negative entry means that negative history scores will be accrued in the score grid  $f(-x)$  and the absolute value of  $X_{16}$  will be used as the score grid multiplier. Positive history scores will then be lumped into the lowest bin with this option. This scaling can be done only in the original problem, not in a CONTINUE run.
  17. If 0, the default angular treatment for partial substeps to generation sites of secondary particles is invoked. This treatment accounts for the probability of the delta function first, then interpolates in the cosine of the deflection angle. It does not preserve the plane in which the deflection angle will lie at the end of the full substep.  
If  $> 0$ , an angular treatment for secondary generation is invoked as follows. The cosine of the electron angle is interpolated and the end-of-substep plane is preserved, but the changing probability of the delta function along the substep is ignored. This option is preserved for further testing of angular algorithms because results have been known to be sensitive to these details.  
If  $< 0$ , the MCNP4A treatment of electron angles at secondary generation sites is invoked. Used with  $dbcn(20)=0$ , comparisons to the earlier treatment can be made.
  18. If 0, the default "MCNP-style" energy indexing algorithm is used, also called the "bin-centered" treatment.  
If  $\neq 0$ , the "ITS-style" energy algorithm is used, also called the "nearest group boundary" treatment. Allows us to match ITS results as closely as possible.
  19. A nonzero  $X_{20}$ th entry causes MCNP to track the previous version of the code, except in the few cases when bugs are too hard to duplicate with this option. Because bug corrections, new features, and enhanced physics must be undone,  $X_{20} \neq 0$  should be used only for debugging purposes.

**CAUTION:** When trying to duplicate a particle history by setting the starting random number with either  $X_7$  or  $X_8$ , the random number sequence may be altered by a default Russian Roulette game on contributions to detectors or DXTRAN spheres. If a problem has detectors or DXTRAN, the only ways to reproduce histories with  $X_7$  or  $X_8$  are: (a) turn off the Russian Roulette game on the DD card by setting  $k = 0$ ; (b) play the roulette game with a fixed criterion by setting  $k < 0$  on the DD card; or (c) reproduce a history with  $NPS < 200$ .

4. FILES File Creation Card

Form:        FILES                    unit no.   filename   access   form   record length

unit no.        =   1 to 99

filename        =   name of the file

access           =   sequential or direct

form             =   formatted or unformatted

record length =   record length in a direct access file

Default:       None; none; sequential; formatted if sequential, unformatted if direct; not required if sequential, no default if direct.

Use:            When a user-modified version of MCNP needs files whose characteristics may vary from run to run. Not legal in a continue-run.

If this card is present, the first two entries are required and must not conflict with existing MCNP units and files. The words “sequential,” “direct,” “formatted,” and “unformatted” can be abbreviated. If more than one file is on the FILES card, the defaults are not much help but the abbreviations will keep it brief. The maximum number of files allowed is six, unless the dimension of the KUFIL array in Fixed Common is increased.

Example:    FILES 21   ANDY S F 0 22   MIKE D U 512

If the filename is DUMN1 or DUMN2, the user can optionally use the execution line message to designate a file whose name might be different from run to run, for instance in a continue-run.

Example:    FILES 17   DUMN1  
              MCNP INP=TEST3   DUMN1=POST3

**Caution:** The names of any user files in a continue-run will be the same as in the initial run. The names are not automatically sequenced if a file of the same name already exists; therefore, a second output file from a continue-run will clobber an existing file of the same name. If you are using the FILES card for an input file and do a continue-run, you will have to provide the coding for keeping track of the record number and then positioning the correct starting location on the file when you continue or MCNP will start reading the file at the beginning.



## CHAPTER 3 DATA CARDS

### 5. PRINT Output Print Tables

Form:        PRINT         $x$

$x$         =    no entry gives the full output print

$x$         =     $x_1 x_2 \dots$  prints basic output plus the tables specified by the table numbers  $x_1, x_2, \dots$

$x$         =     $-x_1 -x_2 \dots$  prints full output except the tables specified by  $x_1, x_2, \dots$

Default:    No PRINT card in the INP file or no PRINT option on the execution line will result in a reduced output print.

Use:        Optional.

The following output will be printed automatically, as applicable:

- a listing of the input file,
- the problem summary of particle creation and loss,
- KCODE cycle summaries,
- tallies,
- tally fluctuation charts, and
- the tables listed below marked basic and default.

You will always get the information indicated by the first five bullets above and the tables labelled “basic” below. They *cannot* be turned off. Tables marked “default” will be printed automatically but they *can* be turned off with the PRINT card.

To get all optional print tables applicable to your problem, indicated in the table below as blank type, use the PRINT card in the INP file or the PRINT option on the execute line. The execute line takes precedence over the input card. Absence of a PRINT card or a PRINT option produces only the tables marked “basic,” “default,” and “shorten.” Entries are allowed only on the PRINT card, not following the PRINT option. Entries on the PRINT card can be in any order.

The PRINT card entries are table numbers of optional and default tables, and control turning the table off or on. If all the entries are positive, you will get the “basic” tables plus the tables requested on the PRINT card. If any entry is negative, you will get all tables applicable to your problem *except* those turned off by the negative entries.

The table number appears in the upper righthand corner of the table, providing a convenient pattern when scanning the output file with an editor. The pattern is PRINT TABLE  $n$ , where  $n$  is preceded always by one space and is a two- or three-digit number. The table numbers and titles and type are summarized in the table below. Tables that can not be controlled by the PRINT card are marked as type “basic.” Tables that are automatically printed but *can* be turned off are marked as type “default.” Tables with no type (blank) can be turned off and on with the PRINT card or option.

Tables 160, 161, and 162 are different from the other tables. If you turn off table 160, tables 161 and 162 will not appear either. If table 160 is printed, they will all be printed. They are all automatically printed if there is no PRINT card or if there is a blank PRINT card. If a PRINT card has a positive entry, tables 160, 161, and 162 will not appear, unless table 160 is explicitly requested. If the entry is negative, they will appear, unless table 160 is explicitly turned off.

Table 175 can not be turned off completely, but the output can be greatly shortened to every 100 cycles plus the last five cycles. PRINT -175 and PRINT 110 both will produce the short version of Table 175.

Table 128, the repeated structure universe map, is special. If table 128 is not turned on in an initial run, it CANNOT be turned on in a subsequent continue-run because the (often large) storage arrays have not been set up. Table 128 is the only print table that affects storage. The information in the other tables is always stored, whether or not it is printed. A warning will be printed in a repeated structures problem if you do not request the universe map/lattice activity table in the original run.

The PRINT control can be used in a continue-run to recover all or any applicable print tables, even if they were not requested in the original run. A continue file with NPS -1 and PRINT will create the output file for the initial run starting with the Problem Summary (located after table 110). Table 128 can never be printed if it was not requested in the original run.

<u>Table Number</u>	<u>Type</u>	<u>Table Description</u>
10		Source coefficients and distribution
20		Weight window information
30		Tally description
35		Coincident detectors
40		Material composition
50		Cell volumes and masses, surface areas
60	basic	Cell importances
62	basic	Forced collision and exponential transform
70		Surface coefficients
72	basic	Cell temperatures
85		Electron range and straggling tables multigroup: flux values for biasing adjoint calcs
86		Electron bremsstrahlung and secondary production
90		KCODE source data
98		Physical constants and compile options
100	basic	Cross section tables
102		Assignment of $S(\alpha,\beta)$ data to nuclides
110		First 50 starting histories

## CHAPTER 3 DATA CARDS

120		Analysis of the quality of your importance function
126	basic	Particle activity in each cell
128		Universe map
130		Neutron/photon/electron weight balance
140		Neutron/photon nuclide activity
150		DXTRAN diagnostics
160	default	TFC bin tally analysis
161	default	$f(x)$ tally density plot
162	default	Cumulative $f(x)$ and tally density plot
170		Source distribution frequency tables, surface source
175	shorten	Estimated $k_{eff}$ results by cycle
178		Estimated $k_{eff}$ results by batch size
180		Weight window generator bookkeeping summary controlled by WWG(7), not print card
190	basic	Weight window generator summary
198		Weight windows from multigroup fluxes
200	basic	Weight window generated windows

Example: PRINT 110 40 150

The output file will contain the “basic” tables plus tables 40, 110, and 150, not 160, 161, 162 (the “default” tables), and the shortened version of 175.

Example: PRINT 170 -70 -110

The output file will contain all the “basic” tables, all the “default” tables, the long version of table 175, and all the optional tables except tables 70, 110, and 170 applicable to your problem.

### 6. M PLOT Plot tally while problem is running

Form: MPLOT MC PLOT keyword=parameter

Default: None.

Use: Optional.

This card specifies a plot of intermediate tally results that is to be produced periodically during the run. The entries are MC PLOT commands for one picture. The = sign is optional. During the run, as determined by the `FREQ n` entry, `MCRUN` will call `MC PLOT` to display the current status of one or more of the tallies in the problem. If a `FREQ n` command is not included on the `M PLOT` card, `n` will be set to 5000. The following commands can not appear on the `M PLOT` card: `RMCTAL`, `RUNTPE`, `DUMP`, and `END`. All of the commands on the `M PLOT` card are executed for each displayed picture, so coplots of more than one bin or tally are possible. No output is sent

to COMOUT. MCPLLOT will not take plot requests from the terminal and returns to MCRUN after each plot is displayed. See Appendix B for a complete list of MCPLLOT commands available.

Another way to plot intermediate tally results is to use the TTY interrupt <ctrl-c>IMCPLLOT or <ctrl-c>IM that allows interactive plotting during the run. At the end of the history that is running when the interrupt occurs, MCRUN will call MCPLLOT, which will take plot requests from the terminal. No output is sent to the COMOUT file. The following commands can not be used: RMCTAL, RUNTPE, DUMP and END.

### 7. PTRAC Particle Track Output Card

Form: PTRAC keyword=parameter(s) keyword=parameter(s)  
 Default: See Table 3.5.  
 Use: Optional.

This card generates an output file, default name PTRAC, of user-filtered particle events. The name PTRAC can be changed on the execution line or within the message block. Using this card without any keywords causes all particle events to be written to the PTRAC file. CAUTION: an extremely large file likely will be created unless NPS is small. Use of one or more keywords listed in Table 3.5 will reduce significantly the PTRAC file size. In Table 3.5 the keywords are arranged into three categories: output control keywords, event filter keywords, and history filter keywords. The output control keywords provide user control of the PTRAC file and I/O. The event filter keywords filter particle events on an event-by-event basis. That is, if the history meets the filter criteria, all filtered events for that history are written to file PTRAC. The PTRAC card keywords can be entered in any order and, in most cases, the corresponding parameter values can appear in any order (exceptions noted below.) The PTRAC card is not legal in a continue-run input file because a change in the PTRAC input would require a readjustment in dynamically allocated storage.

When multiple keywords are entered on the PTRAC card, the filter criteria for each keyword must be satisfied to obtain an output event. For example:

PTRAC FILTER=8,9,erg EVENT=sur NPS=1,50 TYPE=e CELL=3,4

will write only surface crossing events for 8–9 MeV electrons generated by histories 1–50 that have entered cells 3 or 4.

**CHAPTER 3  
DATA CARDS**

**TABLE 3.5: PTRAC Keywords, Parameter Values, and Defaults**

Keyword	Parameter Values	Default	Entries
<b>OUTPUT CONTROL KEYWORDS</b>			
BUFFER	Integer > 0	100	1
FILE	asc, bin	bin	1
MAX	Integer ≠ 0	10000	1
MEPH	Integer > 0	*	1
WRITE	pos, all	pos	1
<b>EVENT FILTER KEYWORDS</b>			
EVENT	src, bnk, sur, col, ter	*	1–5
FILTER	Real, Integer, Mnemonic	*	2–72
TYPE	n, p, e	*	1–3
<b>HISTORY FILTER KEYWORDS</b>			
NPS	Integer > 0	*	1–2
CELL	Integer > 0	*	Unlimited
SURFACE	Integer > 0	*	Unlimited
TALLY	Integer ≠ 0	*	Unlimited
VALUE	Real, Integer	*	Unlimited

- BUFFER** Determines the amount of storage available for filtered events. A small value results in increased I/O and a decrease in required memory, whereas a large value minimizes I/O and increases memory requirements.
- FILE** Controls file type. One of the following values can be entered:  
 asc—generates an ASCII output file.  
 bin—generates a binary output file. This is the default.
- MAX** Sets the maximum number of events to write to the PTRAC file. A negative value terminates MCNP when this value is reached.
- MEPH** Determines the maximum number of events per history to write to the PTRAC  
 Default: write all events.
- WRITE** Controls what particle parameters are written to the PTRAC file.  
 pos—only x, y, z location with related cell and material numbers.  
 all—additionally, u, v, w direction cosines, energy, weight, and time.  
 If the size of the PTRAC file is a concern and the additional parameters are not needed, the default value of “pos” is recommended.
- EVENT** Specifies the type of events written to PTRAC. One or more of the following parameter values can be entered:  
 src—initial source events  
 bnk—bank events

sur—surface events  
col—collision events  
ter—termination events

The bank events include secondary sources, e.g., photons produced by neutrons, as well as particles created by variance reduction techniques, e.g., DXTRAN and energy splitting. See page I-5 for a complete list.

- FILTER** Specifies additional MCNP variables for filtering. The parameter values consist of one or two numerical entries and a variable mnemonic that corresponds to a variable in the PBLCOM common block. See Table 3.6 for available mnemonics. A single numerical entry requires an exact value.  
**EXAMPLE:** FILTER=2,icl writes only those events that occur in cell 2. Two numerical entries represent a range.  
**EXAMPLE:** FILTER=0,10,x writes only those events in which the particle's x-coordinate is between 0 and 10 cm. When a range is specified, the first entry must be less than or equal to the second. Multiple sets of numerical entries and mnemonics are also allowed.  
**EXAMPLE:** FILTER=0.0,10.0,x 0,1,u 1.0,2,erg writes only those events in which the particle's x-coordinate is between 0 and 10 cm and the particle's x-axis cosine is between 0 and 1 and the particle's energy is between 1 and 2 MeV.  
 Default: No additional filtering.
- TYPE** Filters events based on particle type. One or more of the following parameter values can be entered:  
 n—neutron events; p—photon events; e—electron events  
**EXAMPLE:** TYPE=p,e writes only photon and electron events.  
 Default: Events for all particle types are written.
- NPS** Sets the range of particle histories for which events will be output. A single value produces filtered events only for the specified history.  
**EXAMPLE:** NPS=10 writes events only for particle number 10. Two entries indicate a range and will produce filtered events for all histories within that range. The first entry must be less than or equal to the second.  
**EXAMPLE:** NPS=10,20 writes events for particles 10 through 20.  
 Default: Events for all histories.
- CELL, SURFACE, TALLY** The cell, surface, or tally numbers entered after these keywords are used for history filtering. If any track of the history enters listed cells or crosses listed surfaces or contributes to the TFC bin of listed tallies, all filtered events for the history are written to the PTRAC file. See page 3-100 for specification of the TFC bin.  
**EXAMPLE:** CELL=1,2 writes all filtered events for those histories that enter cell 1 or 2.

## CHAPTER 3 DATA CARDS

EXAMPLE: TALLY=4 writes all filtered events for those histories that contribute to tally 4 (see VALUE keyword for filter criteria.) The number of entries following CELL, SURFACE, and TALLY is unlimited. A negative TALLY entry indicates that the corresponding VALUE entry is a multiplier rather than an absolute value.

Default: No history filtering.

### VALUE

Specifies the tally cutoff above which history events will be written.

The number of entries must match those of the TALLY keyword.

EXAMPLE: Tally=4 VALUE=2.0 writes all filtered events of any history that contributes 2.0 or more to the TFC bin of tally 4. A negative TALLY value indicates that the corresponding VALUE entry is a multiplier.

EXAMPLE: TALLY=-4 VALUE=2.0 writes all filtered events of any history that contributes more than  $2.0 * T_a$  to tally 4, where  $T_a$  is the average tally of the TFC bin. The values for  $T_a$  are updated every DMMP histories. Typically, DMMP=1000. See the PRDMP card, page 3-127.

Filtering based on the  $T_a$  values will occur only when they become nonzero.

Thus, when using a multiplier, PTRAC events may not be written for several thousand particles, or at all, if scores are seldom or never made to the TFC bin of the specified tally. In such cases, it is best to enter an absolute value.

EXAMPLE: TALLY=4 VALUE=0.0 writes all filtered events of every history that scores to tally 4.

Default: A multiplier of 10.0 for each tally associated with the TALLY keyword .

**TABLE 3.6: Mnemonic Values for the FILTER Keyword**

<u>Mnemonic</u>	<u>MCNP Variable</u>	<u>Description</u>
X	XXX	X-coordinate of particle position (cm)
Y	YYY	Y-coordinate of particle position (cm)
Z	ZZZ	Z-coordinate of particle position (cm)
U	UUU	Particle X-axis direction cosine
V	VVV	Particle Y-axis direction cosine
W	WWW	Particle Z-axis direction cosine
ERG	ERG	Particle energy (MeV)
WGT	WGT	Particle weight
TME	TME	Time at the particle position (shakes)
VEL	VEL	Speed of the particle (cm/shake)
IMP1	FIML(1)	Neutron cell importance
IMP2	FIML(2)	Photon cell importance
IMP3	FIML(3)	Electron cell importance
SPARE1	SPARE(1)	Spare banked variable
SPARE2	SPARE(2)	Spare banked variable
SPARE3	SPARE(3)	Spare banked variable
ICL	ICL	Problem number of current cell
JSU	JSU	Problem number of current surface
IDX	IDX	Number of current DXTRAN sphere
NCP	NCP	Count of collisions for current branch
LEV	LEV	Geometry level of particle location
III	III	1st lattice index of particle location
JJJ	JJJ	2nd lattice index of particle location
KKK	KKK	3rd lattice index of particle location

8. PERTn Perturbation Card

Form:       PERTn:pl keyword=parameter(s) keyword=parameter(s)

*n*           = unique, arbitrary perturbation number.  
 pl           = N, P, or N,P. Not available for electrons.  
 keyword    = See Table 3.7.

Default:    Some keywords are required. See Table 3.7.

Use:        Optional.

This card allows perturbations in cell material density, composition, or reaction cross-section data. The perturbation analysis uses the first and second order differential operator technique described



## CHAPTER 3 DATA CARDS

in Chapter 2, page 2–191. Using this technique, the perturbation estimates are made without actually changing the input material specifications. Multiple perturbations can be applied in the same run, each specified by a separate PERT card. There is no limit to the number of perturbations because dynamic memory is used for perturbation storage. The entire tally output is repeated for each perturbation, giving the estimated differential change in the tally or this change can be added to the unperturbed tally (see the METHOD keyword). For this reason, the number of tallies and perturbations should be kept to a minimum. A track length estimate of perturbations to  $k_{eff}$  is automatically estimated and printed for KCODE problems. The CELL keyword that identifies one or more perturbed problem cells is required. Also, either the MAT or RHO keyword must be specified.

**TABLE 3.7: PERT Keywords, Parameter Values, and Defaults**

Keyword	Parameter Values	Default	Entries
<b>BASIC KEYWORDS</b>			
CELL	Integer > 0	Required	Unlimited
MAT	Integer > 0	*	1
RHO	Real, integer	*	1
<b>ADVANCED KEYWORDS</b>			
METHOD	±1, 2, 3	1	1
ERG	Real, Integer > 0	All Energies	2
RXN	Integer	1	Unlimited

- CELL** Indicates which cells are perturbed. At least one entry is required, and there is no limit to the number of entries. A comma or space delimiter is required between entries:  
 CELL=1,2,3,4  
 CELL=1 10i 12
- MAT** Specifies the perturbation material number, which must have a corresponding M card. Composition changes can only be made through the use of this keyword. If the RHO keyword is omitted, the MAT keyword is required. Note in the CAUTIONS below that certain composition changes are prohibited.
- RHO** Specifies the perturbed density of the cells listed after the CELL keyword. A positive entry indicates units of atoms/cm<sup>3</sup> and a negative entry indicates units of g/cm<sup>3</sup>. If the MAT keyword is omitted, the RHO keyword is required.
- METHOD** Specifies the number of terms to include in the perturbation estimate.  
 1 — include first and second order (default)  
 2 — include only first order

3 — include only second order

A positive entry produces perturbation tallies that give the estimated **differential** change in the unperturbed tally (default). A negative entry **adds** this change to the unperturbed tally. The ability to produce first and second order terms separately enables the user to determine the significance of including the second-order estimator for subsequent runs. If the second-order results are a significant fraction (20-30%) of the total, then higher order terms are necessary to accurately predict the change in the unperturbed tally. In such cases, the magnitude of the perturbation should be reduced to satisfy this condition. Typically, this technique is accurate to within a few percent for up to 30% changes in the unperturbed tally. It is *strongly* recommended that the magnitude of the second order term be determined before the user continues with this capability.

ERG The two entries specify an energy range in which the perturbation is applied. The default range includes all energies. This keyword is usually used with the RXN keyword to perturb a specific cross-section over a particular energy range.

RXN Entries must be ENDF/B reaction types that identify one or more specific reaction cross-sections to perturb. A list of available ENDF/B reaction types is given in Table I, Appendix G. This keyword allows the user to perturb a single reaction cross-section of a single nuclide in a material, all reaction types of a single nuclide, a single reaction for all nuclides in a material, and a set of cross-sections for all nuclides in a material. The default reaction is the total cross section (RXN=1 for neutrons and multigroup, RXN=-5 for photons.) Relevant nonstandard special R numbers on page 3-88 can be used. Those that cannot be used are -4, -5, -7, and -8 for neutrons; -6 for photons; and -3, -4, -6, and -7 for multigroup problems. If these irrelevant R numbers are used, the following fatal error will be printed: "fatal error. reaction # illegal in perturbation #."

RXN=2 elastic cross section  
RXN=-2 absorption cross section

RXN reaction numbers must be consistent with FM card reaction numbers (see page 3-88) if the perturbation affects the tally cross section. RXN=-6 is most efficient for fission, although MT=18, MT=19, or MT=-2 (multigroup) also work for  $k_{eff}$  and F7 tallies.

## CHAPTER 3 DATA CARDS

### CAUTIONS

1. There is no limit to the number of perturbations, but they should be kept to a minimum as each perturbation can degrade performance by 10-20%.
2. It is not possible to take a region originally specified as void and put in a material with the perturbation technique. However, you can specify a region as containing a material and use the PERT card to make it void by setting RHO=0.
3. It is not possible to introduce a new nuclide into a material composition. However, you can set up the problem with a mixture of all nuclides of interest and use PERT cards to remove one or more (see the examples below).
4. The track length estimate of  $k_{eff}$  in KCODE criticality calculations assumes the fundamental eigenvector (fission distribution) is unchanged in the perturbed configuration.
5. Use caution in selecting the multiplicative constant and reaction number on FM cards used with F4 tallies in perturbation problems. The track length correction term  $R_{I_j}$  is made only if the multiplicative constant on the FM card is negative (indicating macroscopic cross sections with multiplication by the atom density of the cell). If the multiplicative constant on the FM card is positive, it is assumed that any FM card cross sections are independent of the perturbed cross sections. If there is a reaction (RXN) specified on the PERT card, the track length correction term  $R_{I_j}$  is set only if the exact same reaction is specified on the FM card. For example, an entry of RXN=2 on the PERT card is not equivalent to the special elastic reaction -3 on the FM card (should either enter 2 and 2 or -3 and -3).
6. DXTRAN, F5 point detector tallies, and F8 pulse height tallies are not compatible with the PERT card. DXTRAN will give a fatal error; F5 and F8 will give zero perturbations.
7. Large perturbations require higher than second order terms to avoid inaccurate tallies. Refer to the METHOD keyword for a more complete discussion.

### Examples of the PERT Card

Example 1:      PERT1:n,p    CELL=1    RHO=0.03

This perturbation specifies a density change to 0.03 atoms/cm<sup>3</sup> in cell 1. This change is applied to both neutron and photon interactions.

Example 2:      3    1    -1    -1 2 -3 4 -5 6      \$ mat 1 at 1 g/cm<sup>3</sup>  
                  12   1    -1    -7 8 -9 10 -11 12 \$ mat 1 at 1 g/cm<sup>3</sup>  
                  ...

```
C M1 material is semiheavy water
M1 1001 .334 1002 .333 8016 .333
C M8 material is heavy water
M8          1002 .667 8016 .333
PERT2:n    CELL=3,12 MAT=8 RHO=-1.2
```

This perturbation changes the material composition of cells 3 and 12 from material 1 to material 8. The MAT keyword on the PERT card specifies the perturbation material. The material density was also changed from 1.0 to 1.2 g/cm<sup>3</sup> to change from water to heavy water.

Example 3: PERT3:n,p CELL=1 10i 12 RHO=0 METHOD=-1

This perturbation makes cells 1 through 12 void for both neutrons and photons. The estimated changes will be added to the unperturbed tallies.

```
Example 4: 60 13 -2.34 105 -106 -74 73 $ mat 13 at 2.34 g/cm3
...
M13 1001 -.2 8016 -.2 13027 -.2 26000 -.2 29000 -.2
M15 1001 -.2 8016 -.2 13027 -.2 26000 -.2 29000 -.4
PERT1:p CELL=60 MAT=15 RHO=-2.808 RXN=51 9i 61,91
        ERG=1,20
PERT2:p CELL=60 RHO=-4.68 RXN=2
```

This example illustrates sensitivity analysis. The first PERT card generates estimated changes in tallies caused by a 100% increase in the Cu (n,n') cross section (ENDF/B reaction types 51-61 and 91) above 1 MeV. To effect a 100% increase, double the composition fraction (-.2 to -.4) and multiply the ratio of this increase by the original cell density (RHO=[1.2/1.0] \* -2.34 = -2.808 g/cm<sup>3</sup>, where the composition fraction for material 13 is 1.0 and that for material 15 is 1.2.) A change must be made to RHO to maintain the other nuclides in their original amounts. Otherwise, after MCNP normalizes the M15 card, it would be as follows, which is different from the composition of the original material M13:

```
M15 1001 -.167 8016 -.167 13027 -.167 26000 -.167 29000 -.333
```

The second PERT card (PERT2:p) gives the estimated tally change for a 100% increase in the elastic (RXN=2) cross section of material 13. RHO=-2.34 \* 2 = -4.68 g/cm<sup>3</sup>

```
Example 5: M4 6000.60C .5 6000.50C .5
          M6 6000.60C 1
          M8          6000.50C 1
          PERT1:n CELL=3 MAT=6 METHOD=-1
          PERT2:n CELL=3 MAT=8 METHOD=-1
```

## CHAPTER 3

### SUMMARY OF MCNP INPUT FILE

The perturbation capability can be used to determine the difference between one cross-section evaluation and another. The difference between these perturbation tallies will give an estimate of the effect of using different cross section evaluations.

```

Example 6:  1  1  0.05  -1  2  -3  $ mat 1 at 0.05 x 1024 atoms/cm3
            ...
            M1  1001  .1  8016  .2  92235  .7
            M9  1001  .1  8016  .22  92235  .7
            F14:n  1
            FM14  (-1  1  -6  -7  $ keff estimator for cell 1
            PERT1:n  CELL=1  MAT=9  RHO=0.051  METHOD=1
            PERT2:n  CELL=1  MAT=9  RHO=0.051  METHOD=-1
  
```

These perturbations involve a 10% increase in the oxygen atom fraction of material 1 (RHO=0.05 x [1.02/1.0] = 0.051). The effect of this perturbation on tally 14, which is a track length estimate of  $k_{eff}$ , will be provided as a differential change (PERT1) as well as with this change added to the unperturbed estimate of  $k_{eff}$  (PERT2). Note: if the RHO keyword is omitted from the PERT cards, the <sup>235</sup>U composition will be perturbed, which can produce invalid results (see Caution #4.)

```

Example 7:  1  1  -1.5  -1  2  -3  4  -5  6  $ mat 1 at 1.5 g/cm3
            ...
            M1  1001  -.4333  6000  -.2000  8016  -.3667  $ half water
                                     $ half plastic
            M2  1001  -.6666  8016  -.3334  $ water
            M3  1001  -.2000  6000  -.4000  8016  -.4000  $ plastic
            PERT1:n  CELL=1  MAT=2  RHO=-1.0  METHOD=-1
            PERT2:n  CELL=1  MAT=3  RHO=-2.0  METHOD=-1
  
```

This example demonstrates how to make significant composition changes (e.g., changing a region from water to plastic.) The unperturbed material is made from a combination of the two desired materials, typically half of each. PERT1 gives the predicted tally as if cell 1 were filled with water and PERT2 gives the predicted tally as if cell 1 were filled with plastic. The difference between these perturbation tallies is an estimate of the effect of changing cell 1 from water to plastic.

## V. SUMMARY OF MCNP INPUT FILE

### A. Input Cards

The following table lists the various input cards and when they are required. Two kinds of defaults are involved in the following table: (1) if a particular entry on a given card has a default value, that

value is listed in the appropriate location on the card, and (2) the omission of a card from the input file sometimes has a default meaning, and if so, the default description is preceded by an asterisk.

**TABLE 3.8: Summary of MCNP Input Cards**

<u>Use</u>	<u>Card and Defaults</u>		<u>Page</u>
	<u>General Categories</u>		
optional	Message block plus blank terminator		3-1
required	Problem title card		3-2
required	Cell cards plus blank terminator		3-10
required	Surface cards plus blank terminator		3-12
required	Data cards plus blank terminator		3-22
optional	C Comment card		3-4
	<u>Problem type card</u>		page 3-23
(a)	MODE	N	
(a)	Required for all but MODE N		
	<u>Geometry cards</u>		page 3-23
optional	VOL	0	
optional	AREA	0	
optional	U	0	
optional	TRCL	0	
optional	LAT	0	
optional	FILL	0	
optional	TRn	none	
	<u>Variance reduction cards</u>		page 3-32
required	IMP	required unless weight windows used	
optional	ESPLT	*no energy splitting or roulette	
optional	PWT	-1 MODE N P or N P E only	
optional	EXT	0	
optional	VECT	none	
optional	FCL	0	
optional	WWE	none	
required	WWN	required unless importances used	
optional	WWP	5 3 5 0 0 0	
optional	WWG	none	
optional	WWGE	single energy or time interval	

**CHAPTER 3**  
**SUMMARY OF MCNP INPUT FILE**

**TABLE 3.8: Summary of MCNP Input Cards**

optional	MESH	none
optional	PDn	1
optional	DXC	1
optional	BBREM	none electron photon transport only

Source specification cards

page 3-49

optional	SDEF	ERG=14 TME=0 POS=0,0,0 WGT=1
optional	SIn	H $I_i \dots I_k$
optional	SPn	D $P_i \dots P_k$
optional	SBn	D $B_i \dots B_k$
optional	DSn	H $J_i \dots J_k$
optional	SCn	none
optional	SSW	SYM 0
optional	SSR	OLD NEW COL m=0
(b)	KCODE	1000 1 30 130 MAX(4500,2*NSRCK) 0 6500 1 none
(c)	KSRC	none
(b)	ACODE	1000 1 30 130 MAX(4500,2*NSRCK) 0 1 automatic KALSAV+2 6500 0 0

(b) neutron criticality problems only

(c) KCODE or ACODE only

Tally specification cards

page 3-73

optional	Fna	$R_o = 0$ for $n = 5$
optional	FCn	none
optional	En	very large
optional	Tn	very large
optional	Cn	1
optional	FQn	F D U S M C E T
optional	FMn	1
optional	DEn/DFn	none
optional	EMn	1
optional	TMn	1
optional	CMn	1
optional	CFn	none
optional	SFn	none
optional	FSn	none
optional	SDn	0

**TABLE 3.8: Summary of MCNP Input Cards**

optional	FUn	(Requires SUBROUTINE TALLYX)
optional	TFn	1 1 last last 1 last last last
optional	DD	0.1 1000
optional	DXT	----- 0 0 0
optional	FTn	none

Material specification cards

page 3-107

optional	Mm	no ZAID default; 0; set internally; first match in XSDIR; .01p; .01e
(d)	DRXS	*fully continuous
(d)	TOTNU	*prompt $\bar{\nu}$ for non-KCODE; total $\bar{\nu}$ for KCODE
(d)	NONU	*fission treated as real fission
optional	AWTAB	*atomic weights from cross-section tables
optional	XSn	none
optional	VOID	none
optional	PIKMT	*no photon-production biasing
optional	MGOPT	*fully continuous
(d)	neutron problems only	

Energy and Thermal cards

page 3-116

optional	PHYS:N	*very large 0 0
optional	PHYS:P	*100 0 0
optional	PHYS:E	*100 0 0 0 0 1 1 1 1
(e)	TMP	$2.53 \times 10^{-8}$
(e)	THTME	0
(e)	MTm	none
(e)	neutron problems only	

Problem cutoffs

page 3-123

optional	CUT:N	very large 0 -0.5 -0.25 <i>SWTM</i>
optional	CUT:P	very large .001 -0.5 -0.25 <i>SWTM</i>
optional	CUT:E	very large .001 0 0 <i>SWTM</i>
optional	EPLT	cut card energy cutoff
optional	NPS	none
optional	CTME	none



**CHAPTER 3**  
**SUMMARY OF MCNP INPUT FILE**

**TABLE 3.8: Summary of MCNP Input Cards**

	<u>User arrays</u>		page 3–126
optional	IDUM	0	
optional	RDUM	0	
	<u>Peripheral cards</u>		page 3–127
optional	PRDMP	end -15 0 all 10 rendezvous points	
optional	LOST	10 10	
optional	DBCN	(15 <sup>19</sup> ) <sup>152917</sup> 0 0 0 600 0 0 0 1.E-4 100 0 0 152917 5 <sup>19</sup> 0 0 0 0 0 0	
optional	FILES	none none sequential formatted –	
optional	PRINT	*short output	
optional	MPLOT	none	
optional	PTRAC	none	
optional	PERT	none	

\*This describes the effect of not using this particular card.

**B. Storage Limitations**

Table 3.9 summarizes some of the more important limitations that have to be considered when setting up a problem. It may be necessary to modify MCNP to change one or more of these restrictions for a particular problem.

**TABLE 3.9: Storage Limitations**

Entries in the description of a cell	*1000 after processing
Total number of tallies	NTALMX = 100
Detectors	MXDT = 20
Neutron DXTRAN spheres	MXDX = 5
Photon DXTRAN spheres	MXDX = 5
NSPLT or PSPLT card entries	*10
Entries on IDUM card	*50
Entries on RDUM card	*50

\*Set as a dimension in an array

## CHAPTER 4

### EXAMPLES

In this chapter, cookbook examples of several topics provide instructive, real examples that you can follow and learn from. They should be studied in conjunction with the theory and instructions of Chapters 1, 2, and 3. You must understand the geometry discussions in Chapters 1 and 2 before studying the following examples. The concept of combining regions of space bounded by surfaces to make a cell must be fully appreciated; the following examples should help solidify this concept. The use of macrobodies will simplify many geometry definition situations.

Following the geometry specification examples are examples of coordinate transformation, repeated structure and lattice geometries, tally options, source specifications, a SOURCE subroutine, and SRCDX subroutines for point detectors and/or DXTRAN spheres. The tally examples include the FMn, FSn, and FTn cards and the TALLYX subroutine for user-defined tallies using the FUn card.

#### *I. GEOMETRY SPECIFICATION*

Several more examples of the union and complement operators are given to help you understand these features. In all examples, the cell numbers will be circled; the surface numbers will not be circled but will appear next to the surface they represent. All cells are voids.

All examples in this chapter are available at Los Alamos from CFS under the /x6code/manual/examples/chap4 node. The input file for the first example is called **exp1**, etc. You are encouraged to experiment with these files by plotting and modifying them.

The next several examples become progressively more difficult and usually take advantage of what you learned in the preceding ones. Remember that unless altered by parentheses, the hierarchy of operations is that intersections are performed first and then unions.

Example 1: In Figure 4.1a, surfaces 2 and 4 are cylinders and the others are planes with their positive sides to the right. Cells 1 and 2 are easy to specify:

1	0	1	-2-3
2	0	3	-4-5

Cell 3 is harder, and you need to have in mind Figure 1.5 and its explanation. Remember that a union adds regions and an intersection gives you only the areas that overlap or are common to both regions. Regions can be added together more than once—or duplicated—with the union operator.

**CHAPTER 4**  
**GEOMETRY SPECIFICATION**

Let us start the definition of cell 3 at surface 2 (this is not a requirement). The expression  $2 - 3$  defines the following region: everything in the *world* outside surface 2 intersected with everything to the left of surface 3. This region is hatched in Figure 4.1b. Let us examine in detail how Figure 4.1b was derived. First look at each region separately. The area with a positive sense with respect to surface 2 is shown in Figure 4.1c. It includes everything outside surface 2 extending to infinity in all directions. The area with negative sense with respect to surface 2 is undefined so far. The area with negative sense with respect to surface 3 is shown in Figure 4.1d. It includes everything to the left of surface 3 extending to infinity, or half the universe. Recall that an intersection of two regions gives only the area common to **both** regions or the areas that overlap. Superimposing Figures 4.1c and 4.1d results in Figure 4.1e. The cross-hatched regions show the space common to both regions. This is the same area hatched in Figure 4.1b.

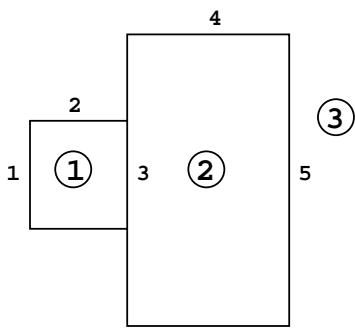

**Figure 4-1a.**

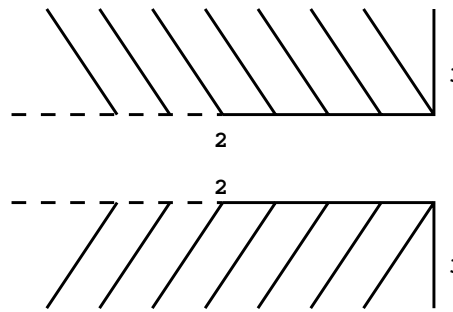

**Figure 4.1b**

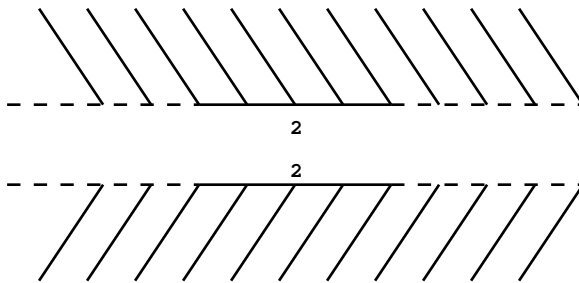

**Figure 4.1c**

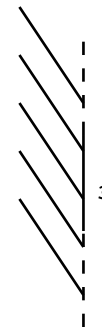

**Figure 4.1d**

Let us now deal with surface 1. To the quantity  $2 - 3$  we will add everything with a negative sense with respect to surface 1 as indicated by the expression  $2 - 3: -1$ , or  $(2 - 3): -1$  if you prefer. Recall (1) that in the hierarchy of operations, intersections are performed first and then unions (so the parentheses are unnecessary in the previous expression), and (2) that a union of two regions results

in a space containing everything in the first region plus everything in the second region; this includes everything common to both regions. Superimposing the region shown in Figure 4.1b and the region to the left of surface 1 results in Figure 4.1f. Our geometry now includes everything hatched plus everything crosshatched and has added part of the tunnel which is interior to surface 2.

By the same method we will deal with surface 4. To the quantity  $2 - 3: -1$  we will add everything with a positive sense with respect to surface 4, written as  $2 - 3: -1: 4$ . Figure 4.1g shows our new geometry. It includes everything in Figure 4.1f plus everything outside surface 4.

Our final step is to block off the large tunnel extending to infinity to the right by adding the region with a positive sense with respect to surface 5 to the region shown in Figure 4.1g. The final expression that defines cell 3 of Figure 4.1a is  $2 - 3: -1: 4: 5$ .

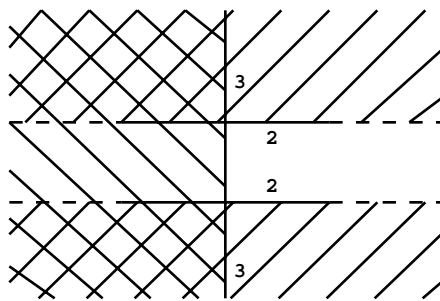

**Figure 4.1e**

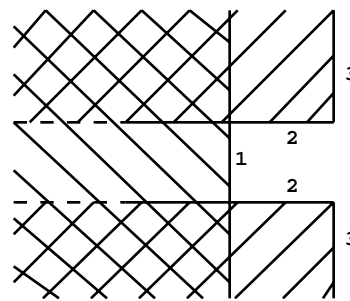

**Figure 4.1f**

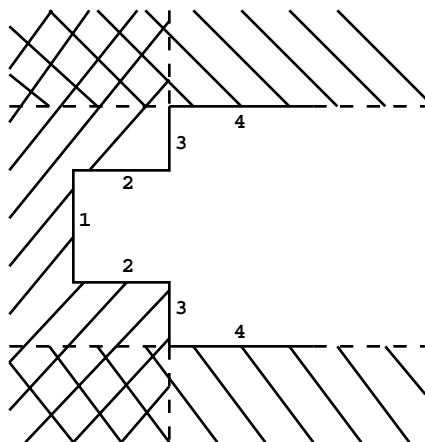

**Figure 4-1g.**

There is more than one way to define cell 3. Starting with surface 1, we can add the region to the left of 1 to the region outside surface 2 or  $-1: 2$ , which is illustrated in Figure 4.1h. We wish to intersect this space with the space having a negative sense with respect to surface 3. Superimposing

**CHAPTER 4**  
**GEOMETRY SPECIFICATION**

Figure 4.1h and the region to the left of surface 3 results in Figure 4.1i. The cross-hatched area indicates the area common to both regions and is the result of the intersection. Note that the cross-hatched area of Figure 4.1i is identical to the entire hatched plus crosshatched area of Figure 4.1f. Therefore, we have defined the same geometry in both figures but have used two different approaches to the problem. To ensure that the intersection of  $-3$  is with the quantity  $-1: 2$  as we have illustrated, we must use parentheses giving the expression  $(-1: 2) -3$ . Remember the order in which the operations are performed. Intersections are done before unions unless parentheses alter the order. The final expression is  $(-1: 2) -3: 4: 5$ .

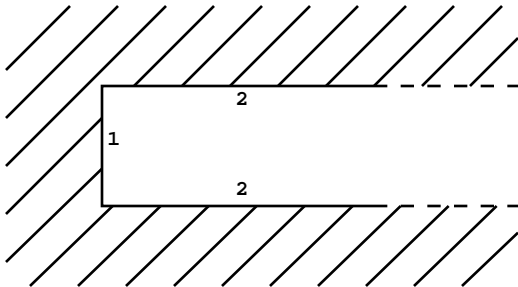

Figure 4.1h

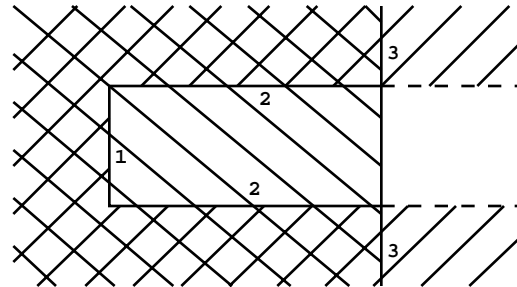
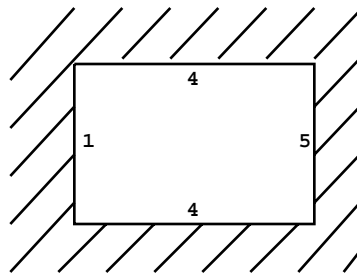

Figure 4.1i

Another tactic uses a somewhat different approach. Rather than defining a small region of the geometry as a starting point and adding other regions until we get the final product, we shall start by defining a block of space and adding to or subtracting from that block as necessary. We arbitrarily choose our initial block to be represented by  $4: -1: 5$ , illustrated in Figure 4.1j.



**Figure 4-1j.**

To this block we need to add the space in the upper and lower left corners. The expression  $2 -3$  isolates the space we need to add. Adding  $2 -3$  to our original block, we have  $4: -1: 5: (2 -3)$ . The parentheses are not required for correctness in this case but help to illustrate the path our reasoning has followed. Figure 4.1k depicts the union of  $2 -3$  with the block of space we originally chose.

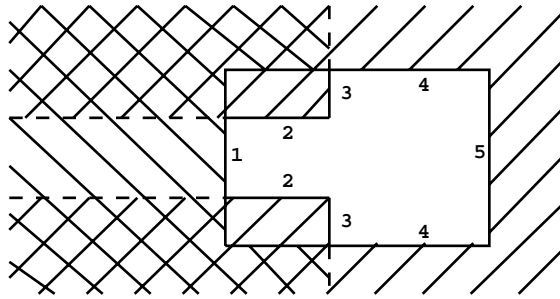

Figure 4-1k.

Let us arbitrarily choose a different initial block, 4: 5: -3, all the world except cell 2. From this region we need to subtract cell 1. If we intersect the region (2: -1) with (4: 5: -3), as shown in Figure 4.1l, we will have introduced an undefined tunnel to the right of surface 5. To correct this error, define an area (2: -1: 3) or (2: -1: 5) and intersect this region with the initial block.

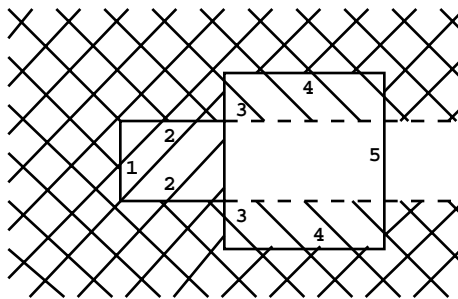

Figure 4.1l.

Another approach is to intersect the two regions -1: 2 and -3: 4, then add that to the region to the right of surface 5 by (-1: 2)(-3: 4): 5. In the above paragraph the expression (4: 5: -3)(2: -1: 5) can have the common quantity: 5 factored out, also resulting in (-1: 2)(-3: 4): 5.

Finally, another approach is to forget about the reality of the geometry and for cell 3 take the inverse (or complement) of all the cells bounding cell 3, which is cells 1 and 2. This says that cell 3 is all of the world excluding that which has already been defined to be in cells 1 and 2. The advantage of this is that cells 1 and 2 are easy to specify and you don't get bogged down in details for cell 3. Cell 3 thus becomes (-1: 2: 3)(-3: 4: 5). Note that the specifications for cells 1 and 2 are reversed. Intersections become unions. Positive senses become negative. Then each piece is intersected with the other. There is a complement operator in MCNP that is a shorthand notation for the above

**CHAPTER 4  
GEOMETRY SPECIFICATION**

expression; it is the symbol #, which can be thought of as meaning **not in**. Therefore, cell 3 is specified by #1 #2, translated as everything in the world that is not in cell 1 and not in cell 2.

Example 2:

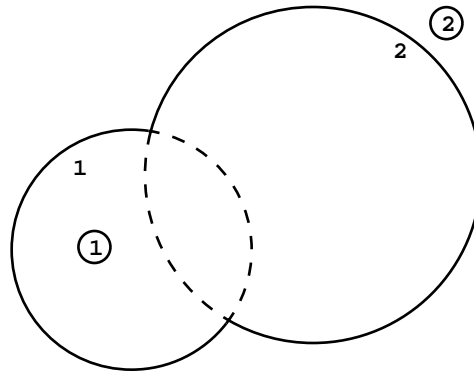
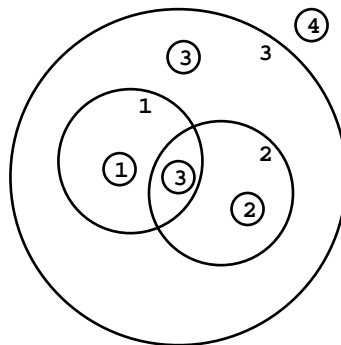

**Figure 4-2.**

Cell 1 is everything interior to the surfaces 1 and 2:

$$\begin{array}{cccc} 1 & 0 & -1 & : & -2 \\ 2 & 0 & 1 & & 2 \end{array}$$

Example 3:



**Figure 4-3.**

In this geometry of four cells defined by three spheres, cell 3 is disconnected. Cell 3 is the region inside surface 3 but outside surfaces 1 and 2 plus the region enclosed between surfaces 1 and 2:

$$\begin{array}{cccc} 1 & 0 & -1 & 2 \\ 2 & 0 & -2 & 1 \end{array}$$

3 0 -3 1 2 : -2 -1  
4 0 3

Cell 3 could also be written as

3 0 (-3 1 2) : (-2 -1)      The parentheses are not required.

Example 4:

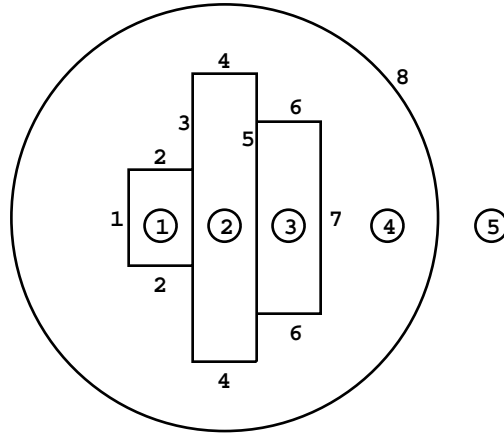

**Figure 4-4.**

In this example all vertical lines are planes with their positive sides to the right and all horizontal lines are cylinders. Cells 1, 2, and 3 are simple; they are defined by 1 -2 -3, 3 -4 -5, and 5 -6 -7, respectively. Cell 4 is simple if the complement operator is used; it is #1 #2 #3 #5 or #1 #2 #3 -8. Cell 5 is also simple; it is no more than 8 (or verbally, everything in the world with a positive sense with respect to surface 8).

If cell 5 were defined as just #4, it would be incorrect. That says cell 5 is everything in the universe not in cell 4, which includes cells 1, 2, and 3. The specification #4 #1 #2 #3 is correct but should not be used because it tells MCNP that cell 5 is bounded by surfaces 1 through 7 in addition to surface 8. This will cause MCNP to run significantly more slowly than it should because anytime a particle enters cell 5 or has a collision in it, the intersection of the particle's trajectory with each bounding surface has to be calculated.

Specifying cell 4 exclusively with the complement operator is very convenient and computationally efficient in this case. However, it will be instructive to set up cell 4 explicitly without complements. There are many different ways to specify cell 4; the following approach should not be considered to be *the* way.

First consider cell 4 to be everything outside the big cylinder of surface 4 that is bounded on each end by surfaces 1 and 7. This is specified by (-1:4:7). The parentheses are not necessary but may



**CHAPTER 4  
GEOMETRY SPECIFICATION**

add clarity. Now all that remains is to add the corners outside cylinders 2 and 6. The corner outside cylinder 2 is (2 -3), whereas it is (5 6) outside cylinder 6. Again the parentheses are optional. These corners are then added to what we already have outside cylinder 4 to get

$$(-1:4:7):(2 -3):(5 6)$$

The region described so far does not include cells 1, 2, or 3 but extends to infinity in all directions. This region needs to be terminated at the spherical surface 8. In other words, cell 4 is everything we have defined so far that is also common with everything inside surface 8 (that is, everything so far intersected with -8). So as a final result,

$$((-1:4:7):(2 -3):(5 6)) -8$$

The inner parentheses can be removed, but the outer ones are necessary (remember the hierarchy of operations) to give us

$$(-1:4:7:2 -3:5 6) -8$$

If the outer parentheses are removed, the intersection of -8 will occur only with 5 and 6, an event that is clearly incorrect.

Example 5:

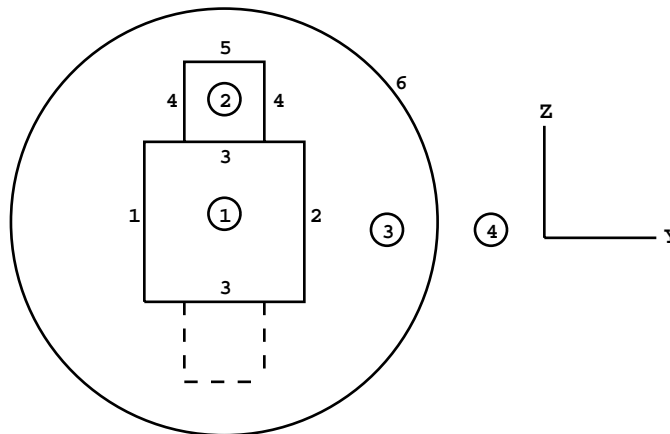

**Figure 4-5.**

This example is similar to the previous one except that a vertical cylinder (surface 4) is added to one side of the horizontal cylinder (surface 3).

Cell 1 is (1 -3 -2), cell 3 is #1 #2 #4, and cell 4 is just 6.

Cell 2 is more than might initially meet the eye. It might appear to be simply  $(-5 -4 3)$ , but this causes a mirror image of the cell 2 we want to show up on the bottom half of cell 1, as represented by the dashed lines in Figure 4.5. We need to add an ambiguity surface to keep cell 2 above the  $y$ -axis. Let surface 7 be an ambiguity surface that is a plane at  $z = 0$ . This surface appears in the MCNP input file as any other surface. Then cell 2 becomes  $(-5 -4 3 7)$  for the final result. You should convince yourself that the region above surface 7 intersected with the region defined by  $-5 -4 3$  is cell 2 (don't even think of surface 7 as an ambiguity surface but just another surface defining some region in space). The mirror problem can also be avoided by defining cells 1 and 2 as a right circular cylinder (rcc) macrobodies. The necessary cards for defining the macrobodies would be

```
1 rcc 0 -2 0 0 4 0 4
2 rcc 0 0 0 0 0 7 1
```

In this case cells 1,2 and 3 would simply be  $(-1)$ ,  $(-2 1)$ , and  $(1 2 -6)$  respectively. Notice that to get the interface between the cylinders correct macrobody 2 extends into cell 1 and is then truncated by the definition of cell 1.

Example 6:

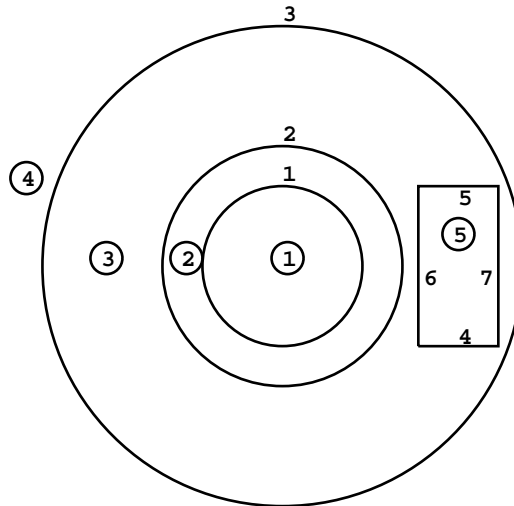

**Figure 4-6.**

This is three concentric spheres with a box cut out of cell 3. Surface 8 is the front of the box and 9 is the back of the box. The cell cards are

```
1 0 -1
2 0 -2 1
3 0 -3 2 (-4:5:-6:7:8:-9)    $ These parentheses are required.
```

**CHAPTER 4  
GEOMETRY SPECIFICATION**

```
4 0 3
5 0 4 -5 6 -7 -8 9
```

Cell 3 is everything inside surface 3 intersected with everything outside surface 2 but not in cell 5. Therefore, cell 3 could be written as

```
3 0 -3 2 #(4 -5 6 -7 -8 9)
or 3 0 -3 2 #5
or 3 0 -3 2 (-4:5:-6:7:8:-9)
```

Cell 5 could also be specified using a RPP macrobody. The correct cell and surface cards for this would be

```
5 0 -4 $
4 rrp 2 4 7.5 8.5 -2 2
```

Example 7:

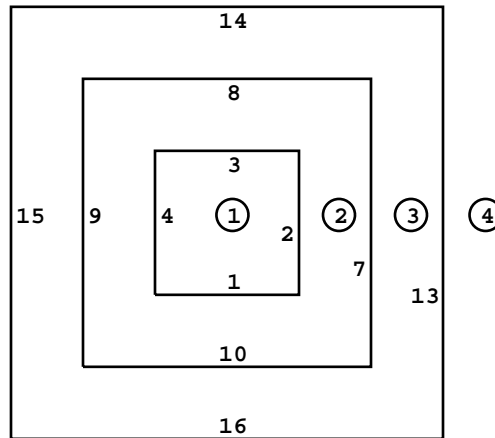
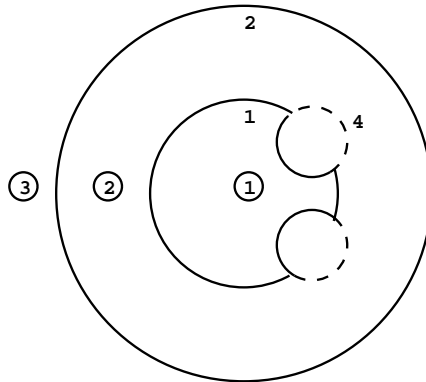

**Figure 4-7.**

This is three concentric boxes, a geometry very challenging to set up using only intersections, easier with unions, and almost trivial with the BOX macrobody. Surfaces 5, 11, and 17 are the back sides of the boxes (smaller to larger, respectively); 6, 12, and 18 are the fronts:

```
1 0 -2 -3 4 1 5 -6
2 0 -7 -8 9 10 11 -12
   (2 : 3 : -4 : -1 : -5 : 6)
3 0 -13 -14 15 16 17 -18
   (7 : 8 : -9 : -10 : -11 : 12)
4 0 13 : 14 : -15: -16 : -17 : 18
```

Example 8:



**Figure 4-8.**

This is two concentric spheres with a torus attached to cell 2 and cut out of cell 1:

$$\begin{array}{cccc} 1 & 0 & -1 & 4 \\ 2 & 0 & -2 & (1 : -4) \\ 3 & 0 & 2 & \end{array}$$

If the torus were attached to cell 1 and cut out of cell 2, this bug-eyed geometry would be:

$$\begin{array}{cccc} 1 & 0 & -1 : -4 & \\ 2 & 0 & -2 & 1 \quad 4 \\ 3 & 0 & 2 & \end{array}$$

Example 9:

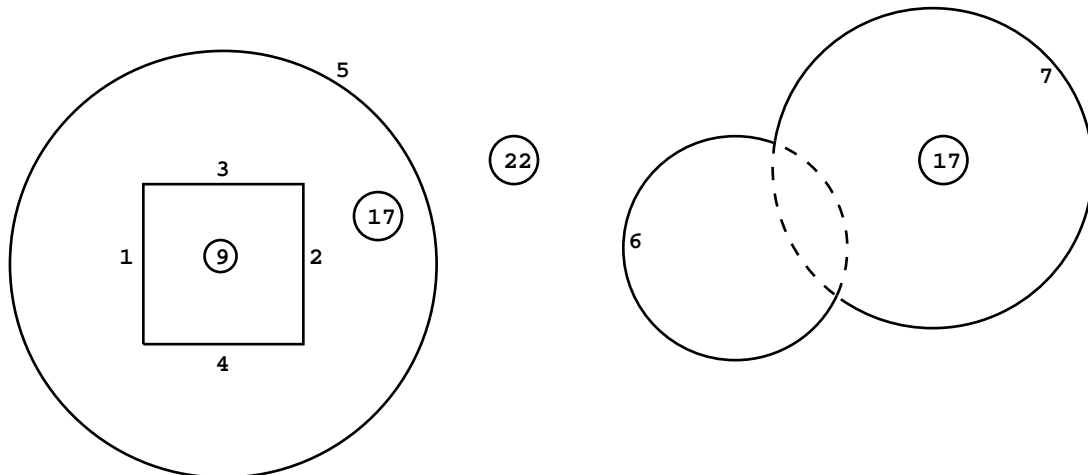

**CHAPTER 4  
GEOMETRY SPECIFICATION**

**Figure 4-9.**

Cell 9 is a box cut out of the left part of spherical cell 17; surface 9 is the front of the box and 8 is the rear. Cell 17 is disconnected; the right part is the space interior to the spheres 6 and 7. An F4 tally in cell 17 would be the average flux in all parts of cell 17. An F2 surface tally on surface 7 would be the flux across only the solid portion of surface 7 in the figure. The cell specifications are:

```

9  0  -3  -2  4  1  8  -9
17 0  -5  (3 : -4 : -1 : 2 : 9 : -8) : -6 : -7
22 0   5   6  7

```

A variation on this problem is for the right portion of cell 17 to be the intersection of the interiors of surfaces 6 and 7 (the region bounded by the dashed lines in the above figure):

```

9  0  -3  -2  4  1  8  -9
17 0  -5  (3 : -4 : -1 : 2 : 9 : -8) : -6  -7
22 0   5   (6 : 7)

```

Example 10:

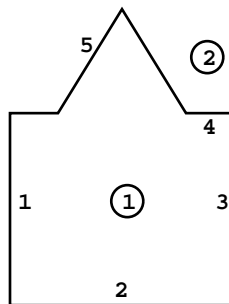

**Figure 4-10.**

This is a box with a cone sitting on top of it. Surface 6 is the front of the box and 7 is the rear. You should understand this example before going on to the next one.

```

1  0  1  2  -3  (-4 : -5)  -6  7
2  0  -1 : -2 : 3 : 4  5 : 6 : -7

```

This problem could be simplified by replacing surfaces 1-6 with a BOX macrobody. The resulting cell and surface cards would be

```

c  cell cards
1  0  -8:(-5 8.5)
2  0  #1 $ or -8.4:-8.6:8.3:(8.5 5):8.1:-8.2

```

```

c surface cards
5 kz 8 0.25 -1
8 box -2.5 -2.5 0 5 0 0 5 0 5

```

Example 11: Surfaces 15 and 16 are cones, surface 17 is a sphere, and cell 2 is disconnected.

```

1 0 -1 2 3 (-4:-16) 5 -6 (12:13:-14)
   (10:-9:-11:-7:8) 15
2 0 -10 9 11 7 -8 -1:2 -12 14 -6 -13 3
3 0 -17 (1:-2:-5:6:-3:-15:16 4)
4 0 17

```

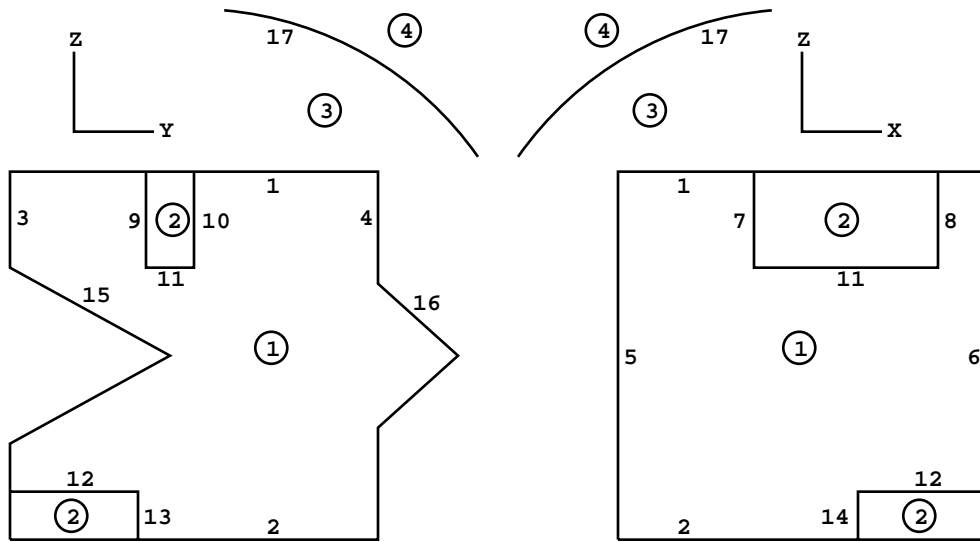

Figure 4-11.

Example 12:

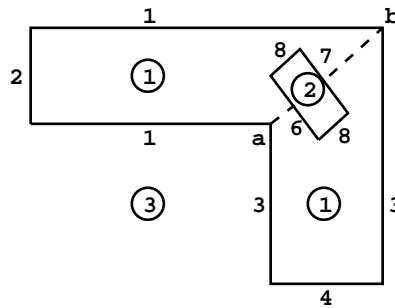

Figure 4-12.

## CHAPTER 4 GEOMETRY SPECIFICATION

Cell 1 consists of two cylinders joined at a 45° angle. Cell 2 is a disk consisting of a cylinder (surface 8) bounded by two planes. Surface 5 is a diagonal plane representing the intersection of the two cylinders. The problem is to specify the disk (cell 2) in one cell formed by the two cylinders (cell 1). A conflict arises in specifying cell 1 since, from the outside cell 3, corner *a* between surfaces 1 and 3 is convex, but on the other side of the cell the same two surfaces form a concave corner at *b*. The dilemma is solved by composing cell 1 of two disconnected cells, each bounded by surface 5 between the corners *a* and *b*. Surface 5 must be included in the list of surface cards in the MCNP input file. When the two parts are joined to make cell 1, surface 5 does not appear. Convince yourself by plotting it using an origin of 0 0 24 and basis vectors 0 1 1 0 -1 1. See Appendix B for an explanation of plotting commands.

```
1  0  (2 -1 -5 (7:8:-6)):(4 -3 5(-6:8:7))
2  0  -8 6 -7
3  0  (-2:1:5)(-4:3:-5)
```

A more efficient expression for cell 1 is

```
1  0  (2 -1 -5:4 -3 5)(-6:8:7)
```

### Example 13:

This example has the most complicated geometry so far, but it can be described very simply. The input file is called `antares` and is available from the `/x6code/manual/examples/chap4` node.

You can see that Example 13 is similar to Example 1. There is just a lot more of it. It is possible to set this geometry up by any of the ways mentioned in Example 1. However, going around the outer surfaces of the cells inside cell 10 is tedious. There is a problem of visualization and also the problem of coming up with undefined tunnels going off to infinity as in Example 1.

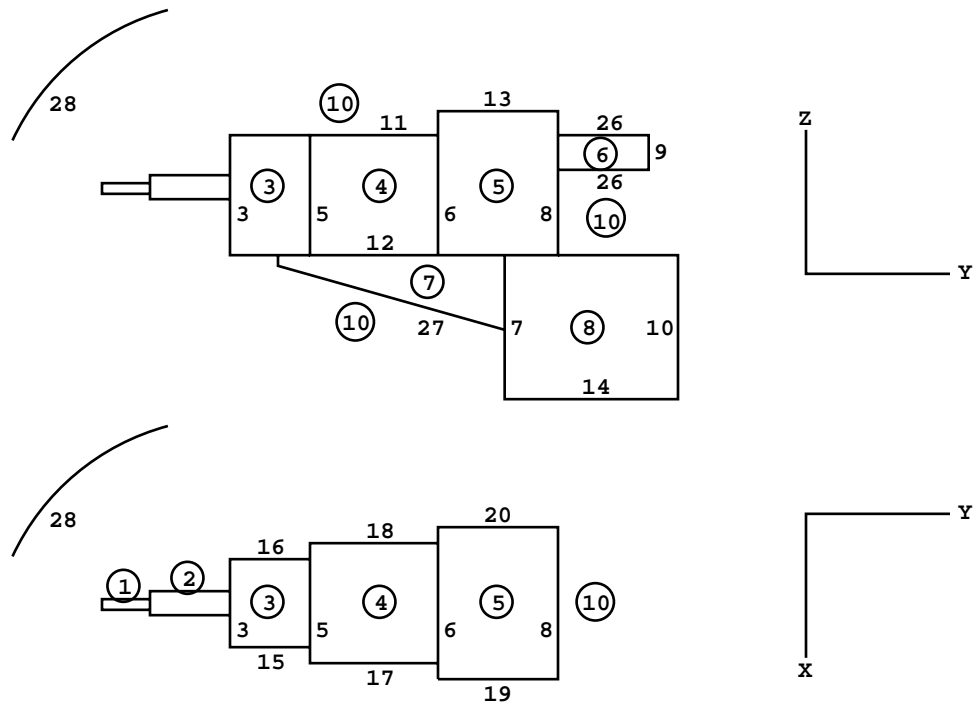

Figure 4-13.

The way to handle this geometry is by the last method in Example 1. Set up the cell/surface relations for each interior cell, then just take the complement for cell 10. For the interior cells,

1	0	1	-2	-23			
2	0	-3	25	-24	2		
3	0	3	-5	12	-15	16	-11
4	0	5	-6	12	-17	18	-11
5	0	6	-8	12	-13	-19	20
6	0	8	-9	-26			
7	0	-12	4	-7	-27		
8	0	-12	7	-10	14	-21	22
9	0	2	-3	-25			

Cell 10 is surrounded by the spherical surface 28. Considering cell 10 to be everything outside cells 1 through 9 but inside surface 28, one can reverse the senses and replace all intersections with unions to produce



**CHAPTER 4**  
**GEOMETRY SPECIFICATION**

```

10  0  (-1:2:23)(3:-25:24:-2)
      (-3:5:-12:15:-16:11)
      (-5:6:-12:17:-18:11)
      (-6:8:-12:13:19:-20)
      (-8:9:26)(12:-4:7:27)
      (12:-7:10:-14:21:-22)
      (-2:3:25) -28

```

Note how easy cell 10 becomes when the complement operator is used:

```

10  0  #1 #2 #3 #4 #5 #6 #7 #8 #9 -28

```

Once again this example can be greatly simplified by replacing all but cell 7 with macrobodies. However the definition of cell 7 must then be changed to use the facets of the surrounding macrobodies instead of surfaces 12 and 7. The facets of macrobodies can be visualized using the MBODY OFF option of the geometry plotter.

Example 14:

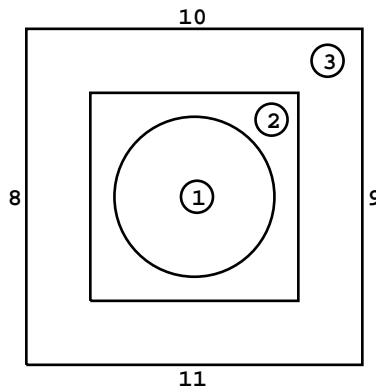

**Figure 4-14.**

This example illustrates some necessary conditions for volume and area calculations. The geometry has three cells, an outer cube, an inner cube, and a sphere at the center. If cell 3 is described as

```

3  0  8 -9 -10 11 -12 13 #2 #1

```

(and #1 must be included to be correct), the volume of cell 3 cannot be calculated. As described, it is not bounded by all planes so it is not a polyhedron, nor is it rotationally symmetric. If cell 3 is described by listing all 12 bounding surfaces explicitly, the volume can be calculated.

**II. COORDINATE TRANSFORMATIONS**

In most problems, the surface transformation feature of the TRn card will be used with the default value of 1 for  $M$ . When  $M = 1$  applies, most of the geometry can be set up easily in an  $(x,y,z)$  coordinate system and only a small part of the total geometry will be difficult to specify. For example, a box with sides parallel to the  $(x,y,z)$  coordinate system is simple to describe, but inside might be a tilted object consisting of a cylinder bounded by two planes. Since the axis of the cylinder is neither parallel to nor on the  $x$ ,  $y$ , or  $z$  axis, a general quadratic must be used to describe the surface of the cylinder. The GQ surface card has 10 entries that are usually difficult to determine. On the other hand, it is simple to specify the entries for the surface card for a cylinder centered on the  $y$ -axis. Therefore, we define an auxiliary coordinate system  $(x',y',z')$  so the axis of the cylinder is one of the primed axes,  $y'$  for example. Now we will use the TRn card to describe the relationship between one coordinate system and the other.  $M = 1$  requires that the coordinates of a vector from the  $(x,y,z)$  origin to the  $(x',y',z')$  origin be given in terms of  $(x,y,z)$ .

Only in rare instances will  $M = -1$  be needed. Some unusual circumstances may require that a small item of the geometry must be described in a certain system which we will call  $(x,y,z)$ , and the remainder of the surfaces would be easily described in an auxiliary system  $(x',y',z')$ . The  $O_i$  entries on the TRn card are then the coordinates of a vector from the  $(x',y',z')$  origin to the  $(x,y,z)$  origin given in terms of the primed system.

Example 1: The following example consists of a can whose axis is in the  $yz$  plane and is tilted  $30^\circ$  from the  $y$ -axis and whose center is at  $(0,10,15)$  in the  $(x,y,z)$  coordinate system. The can is bounded by two planes and a cylinder, as shown in Figure 4.15.

The surface cards that describe the can in the simple  $(x',y',z')$  system are:

- |   |   |    |    |
|---|---|----|----|
| 1 | 1 | CY | 4  |
| 2 | 1 | PY | -7 |
| 3 | 1 | PY | 7  |

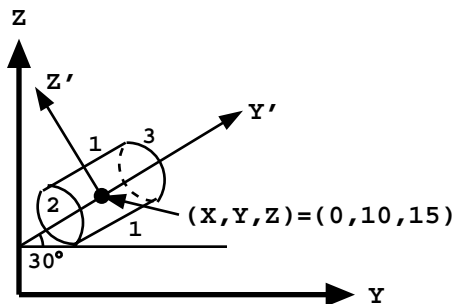

**Figure 4-15.**

## CHAPTER 4 COORDINATE TRANSFORMATIONS

The 1 before the surface mnemonics on the cards is the  $n$  that identifies which TR $n$  card is to be associated with these surface cards. The TR $n$  card indicates the relationship of the primed coordinate system to the basic coordinate system.

We will specify the origin vector as the location of the origin of the  $(x',y',z')$  coordinate system with respect to the  $(x,y,z)$  system; therefore,  $M = 1$ . Since we wanted the center of the cylinder at  $(0,10,15)$ , the  $O_i$  entries are simply 0 10 15. If, however, we had wanted surface 2 to be located at  $(x,y,z) = (0,10,15)$ , a different set of surface cards would accomplish it. If surface 2 were at  $y' = 0$  and surface 3 at  $y' = 14$  the  $O_i$  entries would remain the same. The significant fact to remember about the origin vector entries is that they describe one *origin* with respect to the other *origin*. The user must locate the surfaces about the auxiliary origin so that they will be properly located in the main coordinate system.

The  $B_i$  entries on the TR $n$  card are the cosines of the angles between the axes as listed on page 3–26 in Chapter 3. In this example, the  $x$ -axis is parallel to the  $x'$ -axis. Therefore, the cosine of the angle between them is 1. The angle between  $y$  and  $x'$  is  $90^\circ$  with a cosine of 0. The angle between  $z$  and  $x'$  and also between  $x$  and  $y'$  is  $90^\circ$  with a cosine of 0. The angle between  $y$  and  $y'$  is  $30^\circ$  with a cosine of 0.866. The angle between  $z$  and  $y'$  is  $60^\circ$  with 0.5 being the cosine. Similarly,  $90^\circ$  is between  $x$  and  $z'$ ;  $120^\circ$  is between  $y$  and  $z'$ ; and  $30^\circ$  is between  $z$  and  $z'$ . The complete TR $n$  card is

```
TR1 0 10 15 1 0 0 0 .866 .5 0 -.5 .866
```

An asterisk preceding TR $n$  indicates that the  $B_i$  entries are the angles in degrees between the appropriate axes. The entries using the \*TR $n$  mnemonic are

```
*TR1 0 10 15 0 90 90 90 30 60 90 120 30
```

The default value of 1 for  $M$ , the thirteenth entry, has been used and is not explicitly specified.

The user need not enter values for all of the  $B_i$ . As shown on page 3–26,  $B_i$  may be specified in any of five patterns. Pattern #1 was used above, but the simplest form for this example is pattern #4 since all the skew surfaces are surfaces of revolution about some axis. The complete input card then becomes

```
*TR1 0 10 15 3J 90 30 60
```

Example 2: The following example illustrates another use of the TR $n$  card. The first part of the example uses the TR1 card and an  $M = 1$  transformation; the second part with the TR2 card uses an  $M = -1$  transformation. Both parts and transformations are used in the following input file.

### EXAMPLE OF SURFACE TRANSFORMATIONS

```
2 0 -4 3 -5
6 0 -14 -13 : -15 41 -42
3 1 PX -14
```

```

4  1  X   -14 10 0 12 14 10
5  1  PX   14
13 2  SX  -15 70
14 2  CX   30
15 2  Y    75 0 30 16
41 2  PY   0
42 2  PY   75

TR1  20 31 37 .223954 .358401 .906308
TR2 -250 -100 -65 .675849 .669131 .309017
J  J .918650 J  J -.246152 -1

```

**A. TR1 and M = 1 Case:**

Cell 2 is bounded by the plane surfaces 3 and 5 and the spheroid surface 4, which is a surface of revolution about the skew axis  $x'$  in Figure 4.16.

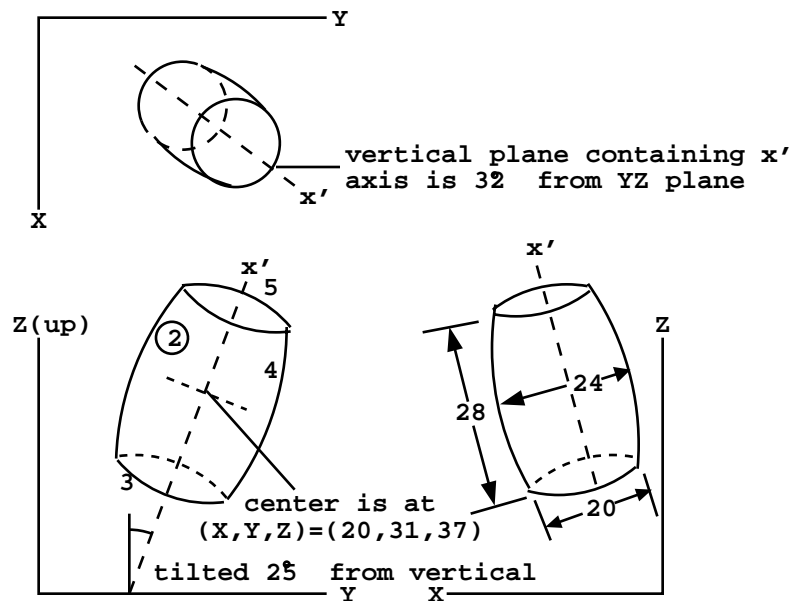

**Figure 4-16.**

To get the coefficients of surfaces 3, 4, and 5, define the  $x'$  axis as shown in the drawings (since the surfaces are surfaces of revolution about the  $x'$  axis, the orientation of the  $y'$  and  $z'$  axes does not matter), then set up cell 2 and its surfaces, with coefficients defined in the  $x'y'z'$  coordinate system.

On the TR1 card, the origin vector is the location of the origin of the  $x'y'z'$  coordinate system with respect to the main  $xyz$  system of the problem. The pattern #4 on page 3-26 in Chapter 3 is

**CHAPTER 4**  
**COORDINATE TRANSFORMATIONS**

appropriate since the surfaces are all surfaces of revolution about the  $x'$  axis. The components of one vector of the transformation matrix are the cosines of the angles between  $x'$  and the  $x$ ,  $y$ , and  $z$  axes. They are obtained from spherical trigonometry:

$$\begin{aligned} \cos E &= \cos 58^\circ \times \sin 25^\circ = .223954 \\ \cos F &= \cos 32^\circ \times \sin 25^\circ = .358401 \\ \cos G &= \cos 25^\circ = .906308 \end{aligned}$$

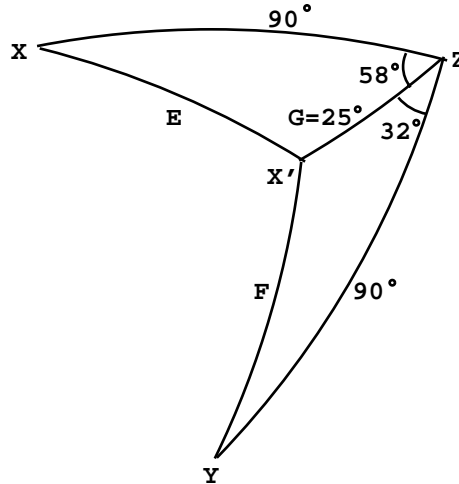

**B. TR2 and M = -1 Case:**

Cell 6 is the union of a can bounded by spherical surface 13 and cylindrical surface 14 and a conical piece bounded by conical surface 15 and ambiguity surfaces 41 and 42, which are planes. (Surface 42 is required because when surface 15 is defined in  $x'y'z'$  it is as a type Y surface, which becomes a cone of one sheet; when it is transformed into the  $xyz$  system it becomes a type GQ surface, which in this case is a cone of two sheets. Weird, but that's the way it has to be.) Surfaces 13 and 14 are surfaces of revolution about one axis, and surfaces 15, 41, and 42 are surfaces of revolution about an axis perpendicular to the first axis. Both axes are skewed with respect to the  $xyz$  coordinate system of the rest of the geometry.

Define the auxiliary  $x'y'z'$  coordinate system as shown in Figure 4.17. Set up cell 6 with its surfaces specified in the  $x'y'z'$  coordinate system as part of the input file and add a second transformation card, TR2.

Because the location of the origin of the  $xyz$  coordinate system is known relative to the  $x'y'z'$  system (rather than the other way around, as in the first part of the example), it is necessary to use the reverse mapping. This is indicated by setting  $M = -1$ . In this reverse mapping the origin vector  $(-250, -100, -65)$  is the location of the origin of the  $xyz$  system with respect to the  $x'y'z'$  system. For the components of the transformation matrix, pattern #3 out of the four possible choices from Chapter 3 is most convenient here. The  $xyz$  components of  $z'$  and the  $x'y'z'$  components of  $z$  are easy to get. The components of  $x$  and of  $y$  are not. The whole transformation matrix is shown here with

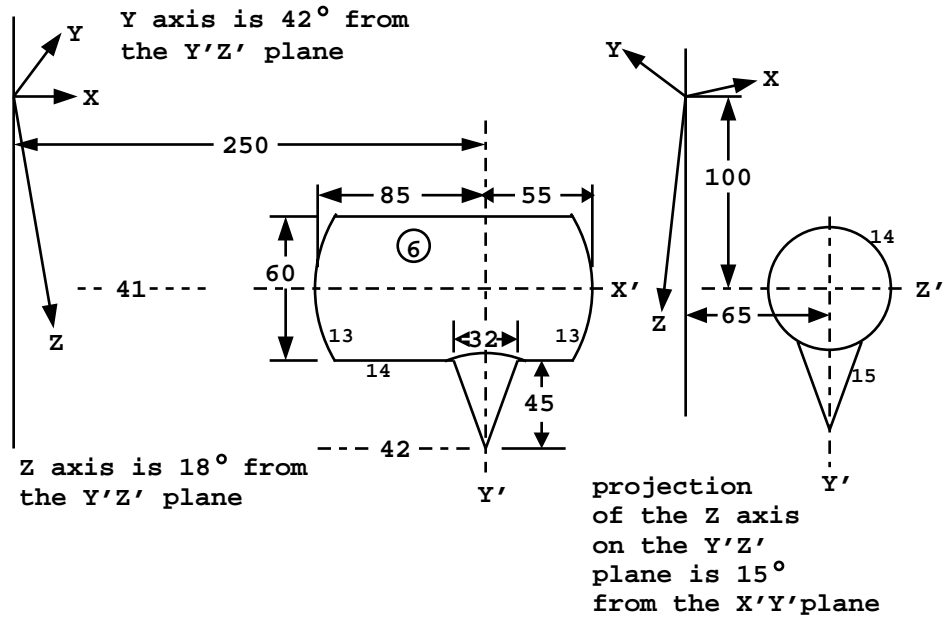

**Figure 4-17.**

the components that are obtained from Figure 4.17 written in:

	<i>x</i>	<i>y</i>	<i>z</i>
<i>x'</i>	.675849	$\cos 48^\circ = .669131$	$\cos 72^\circ = .309017$
<i>y'</i>			$\cos 15^\circ \times \cos 18^\circ = .918650$
<i>z'</i>			-.246152

The  $zz'$  component is  $-\text{SQRT}(1. - .309107**2 - .918650**2) = -.246152$ , and the  $xx'$  component is  $\text{SQRT}(1. - .669131**2 - .309017**2) = .675849$ , with the signs determined by inspection of the figure.

### ***III. REPEATED STRUCTURE AND LATTICE EXAMPLES***

Example 1: This example illustrates the use of transformations with simple repeated structures. The geometry consists of a sphere enclosing two boxes that each contain a cylindrical can. Cell 2 is filled by universe 1. Two cells are in universe 1—the cylindrical can, cell 3, and the space outside the can, cell 4. Cell 2 is defined and the LIKE m BUT card duplicates the structure at another location. The TRCL entry identifies a TRn card that defines the displacement and rotational axis transformation for cell 5. To plot type:

b 1 0 0 0 1 0 ex 11 or 3.5 3.5 0

**CHAPTER 4**  
**REPEATED STRUCTURE AND LATTICE EXAMPLES**

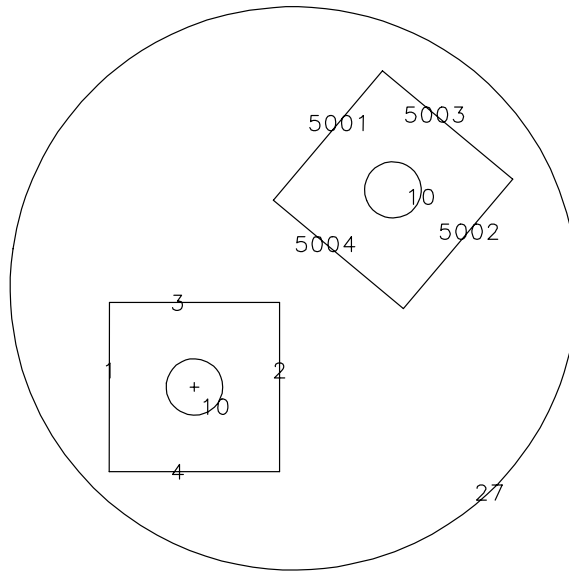

```

simple repeated structures
1 0 -27 #2 #5          imp:n=1
2 0 1 -2 -3 4 -5 6    fill=1 imp:n=1
3 0 -10 -11 12        u=1   imp:n=1
4 0 #3                u=1   imp:n=1
5 like 2 but trcl=3
7 0 27                imp:n=0

1 px -3
2 px 3
3 py 3
4 py -3
5 pz 4.7
6 pz -4.7
10 cz 1
11 pz 4.5
12 pz -4.5
27 s 3.5 3.5 0 11

sdef pos 3.5 3.5 0
f2:n 1
tr3* 7 7 0 40 130 90 50 40 90 90 90 0
nps 10000

```

**CHAPTER 4**  
**REPEATED STRUCTURE AND LATTICE EXAMPLES**

Example 2: This example illustrates the LIKE m BUT construct, the FILL card, the U card, two forms of the TRCL card, and a multiple source cell definition. The following line will plot the view shown on the left:

b 1 0 0 0 1 0 ex 21 la 0

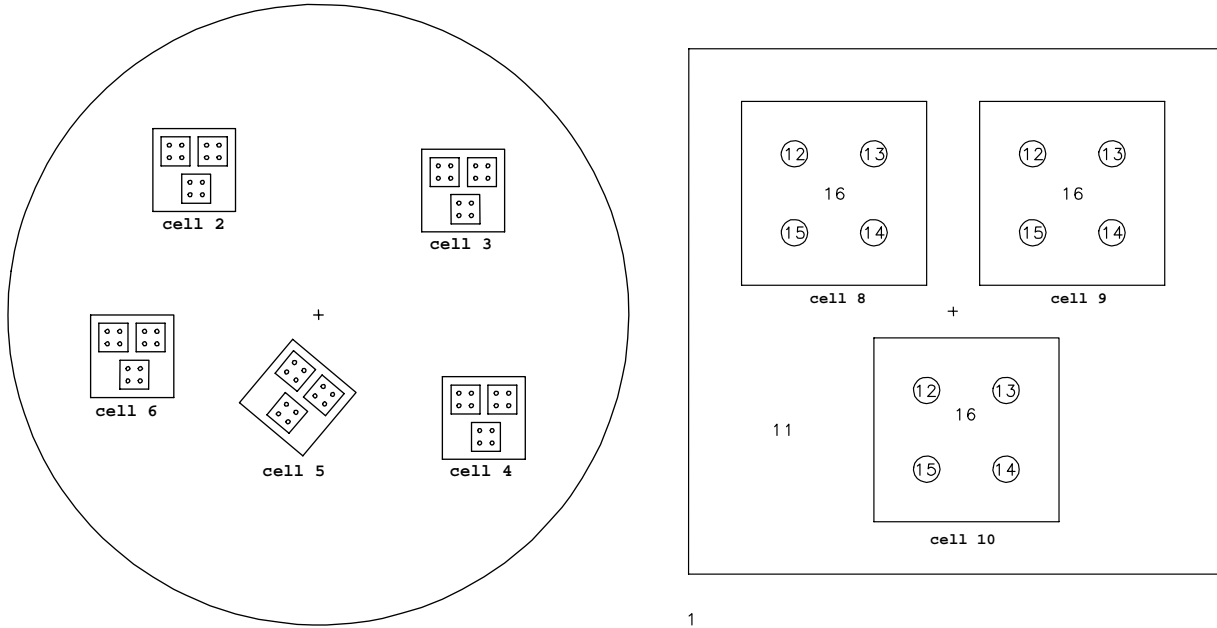

In this example five cells, numbers 2 through 6, are identical except for their locations. Cell 2 is described fully and the other four are declared to be like cell 2 but in different locations. Cell 2 is defined in an auxiliary coordinate system that is centered in the cell for convenience. That coordinate system is related to the main coordinate system of the problem by transformation number 2, as declared by the TRCL = 2 entry and the TR2 card. Cells 2 through 6 are all filled with universe number 1. Because no transformation is indicated for that filling, universe 1 inherits the transformation of each cell that it fills, thereby establishing its origin in the center of each of those five cells. Universe 1 contains three infinitely long tubes of square cross section embedded in cell 11, which is unbounded. All four of these infinitely large cells are truncated by the bounding surfaces of each cell that is filled by universe 1, thus making them effectively finite. The transformations that define the locations of cells 8, 9 and 10 are entered directly on the cell cards after the TRCL symbol rather than indirectly through TR cards as was done for cells 2 through 6 to illustrate the two possible ways of doing this. Cells 8, 9 and 10 are each filled with universe 2, which consists of five infinite cells that are truncated by the boundaries of higher level cells. The simplicity and lack of repetition in this example were achieved by careful choice of the auxiliary



## CHAPTER 4

### REPEATED STRUCTURE AND LATTICE EXAMPLES

coordinate systems at all levels. All of the location information is contained in just a few TRCL entries, some direct and some pointing to a few TR cards.

The source definition is given on the SDEF, SIn and SPn cards. The source desired is a cylindrical volume distribution, equally probable in all the cylindrical rods. The energies are given by distribution 1. The entry for CEL shows that level 0 cells are given by distribution 2 and level 1 cells by distribution 3. The zero means that cells are searched for at level 2 and also that the sampled position and direction will apply to the universe indicated by the entry just preceding the first entry that is  $\leq 0$ . In this case the position and direction will be defined in the coordinate system of the cell sampled by distribution 3 at level 1. The SI2 card lists all the cells at level 0 that will contain the source. SP2 indicates equal probability. SI3 lists the cells in level 1 and the positions on the SI7 card are given in the coordinates of this level. A cylindrical volume distribution is specified by RAD, EXT, AXS, and POS. The radius on the SI5 card is from 0 to .1. The ends of the cylinder are at -2 and 2 (SI6) and the four sets of entries on the SI7 card are the origins of the four cylinders of cells 12–15. These parameters describe exactly the four cells 12–15.

#### chapter 4 example 2

```
1  1 -5 -7 #2 #3 #4 #5 #6 imp:n=1
2  0 1 -2 -3 4 5 -6 imp:n=2 trcl=2 fill=1
3  like 2 but trcl=3
4  like 2 but trcl=4
5  like 2 but trcl=5 imp:n=1
6  like 2 but trcl=6
7  0 7 imp:n=0
8  0 8 -9 -10 11 imp:n=1 trcl=(-.9 .9 0) fill=2 u=1
9  like 8 but trcl=(.9 .9 0)
10 like 8 but trcl=(.1 -.9 0)
11 2 -18 #8 #9 #10 imp:n=1 u=1
12 2 -18 -12 imp:n=1 trcl=(-.3 .3 0) u=2
13 like 12 but trcl=(.3 .3 0)
14 like 12 but trcl=(.3 -.3 0)
15 like 12 but trcl=(-.3 -.3 0)
16 1 -.5 #12 #13 #14 #15 u=2 imp:n=1

1  px -2
2  py 2
3  px 2
4  py -2
5  pz -2
6  pz 2
7  so 15
8  px -.7
```

**CHAPTER 4**  
**REPEATED STRUCTURE AND LATTICE EXAMPLES**

```

9      py  .7
10     px  .7
11     py -.7
12     cz  .1

sdef   erg=d1 cel=d2:d3:0 rad=d5 ext=d6 axs=0 0 1 pos=d7
#      si1  sp1  sb1
      1    0    0
      3   .22  .05
      4   .08  .05
      5   .25  .1
      6   .18  .1
      7   .07  .2
      8   .1   .2
      9   .05  .1
     11   .05  .2
si2    1 2 3 4 5 6
sp2    1 1 1 1
si3    1 8 9 10
sp3    1 1 1
si5    0 .1
sp5   -21 1
si6   -2 2
sp6    0 1
si7    1 .3 .3 0 .3 -.3 0 -.3 .3 0 -.3 -.3 0
sp7    1 1 1 1
m1     6000 1
m2     92235 1
drxs
tr2   -6 7 1.2
tr3    7 6 1.1
tr4    8 -5 1.4
tr5*  -1 -4 1 40 130 90 50 40 90 90 90 0
tr6   -9 -2 1.3
f4:n   2 3 4 5 6 12 13 14 15
e4     1 3 5 7 9 11 13
sd4    5j 1.8849555921 3r
fq     f e
cut:n  1e20 .1
nps    100000
print

```

**CHAPTER 4**  
**REPEATED STRUCTURE AND LATTICE EXAMPLES**

Cell 2 could be replaced with a RPP macrobody that can then be replicated and translated identically to cell 2 above.

Example 3:

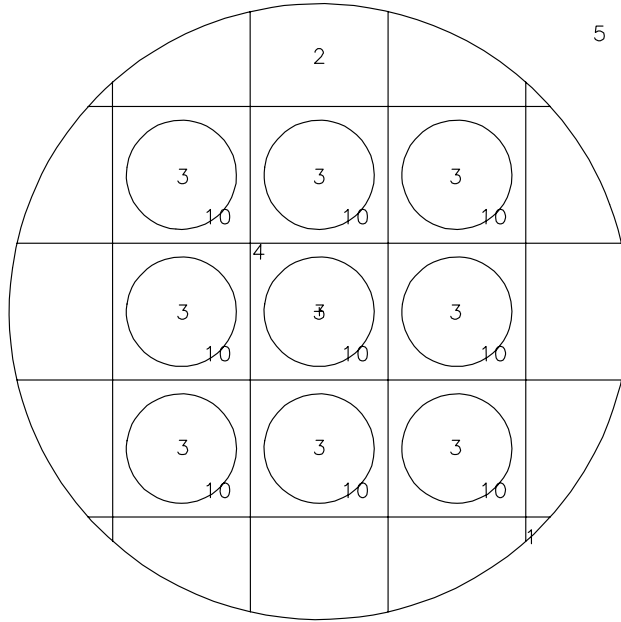

This is a simple example illustrating the use of the FILL, U, and LAT cards to create an object within several cells of a lattice. A hexahedral lattice is contained within a cylinder of radius 45 cm. Cell 1 is the interior of the cylinder, and cell 5 is everything outside (all surfaces are infinite in the z-direction). Cell 1 is filled by universe 1. Cell 2 is defined to be in universe 1. Surfaces 301-304 define the dimensions of the square lattice.

When filling the cells of a lattice, all cells visible, even partially, must be specified by the FILL card. In this case, the “window” created by the cylinder reveals portions of 25 cells (5x5 array). A FILL card with indices of -2 to 2 in the x- and y-directions will place the [0,0,0] element at the center of the array. Universe 2, described by cells 3 and 4, is the interior and exterior, respectively, of an infinite cylinder of radius 8 cm. The cells in universe 1 not filled by universe 2 are filled by universe 1, in effect they are filled by themselves. The following file describes a cylinder that contains a square lattice, with the inner 3x3 array of cells containing a small cylinder in each cell.

simple lattice

```

1  0 -1 fill=1 imp:n=1
2  0 -301 302 -303 304 lat=1 u=1 imp:n=1 fill=-2:2 -2:2 0:0
   1 1 1 1 1 1 2 2 2 1 1 2 2 2 1 1 2 2 2 1 1 1 1 1 1 1

```

**CHAPTER 4**  
**REPEATED STRUCTURE AND LATTICE EXAMPLES**

```

3  0 -10 u=2 imp:n=1
4  0 #3 imp:n=1 u=2
5  0 1 imp:n=0

1  cz 45
10 cz 8
301 px 10
302 px -10
303 py 10
304 py -10

```

Example 4:

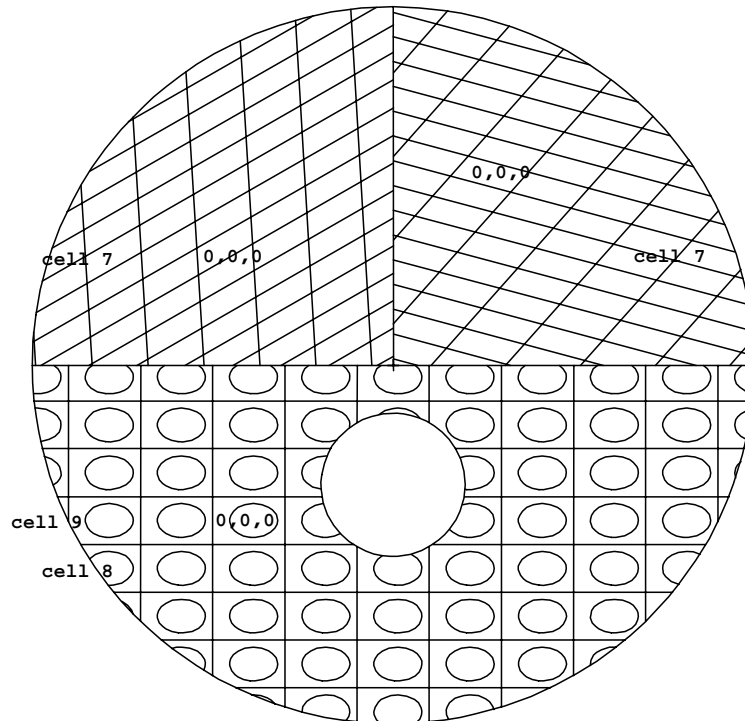

This example illustrates a lattice geometry and uses the FILL entries followed by transformations, the U card, and the LAT card. Cell 2 is the bottom half of the large sphere outside the small sphere (cell 1), is filled by universe 1, and the transformation between the filled cell and the filling universe immediately follows in parentheses.

Cell 6 describes a hexahedral lattice cell (LAT=1) and by the order of specification of its surfaces, also describes the order of the lattice elements. The (0,0,0) element has its center at (-6 -6.5 0) according to the transformation information on the card for cell 2. Element (1,0,0) is

## CHAPTER 4

### REPEATED STRUCTURE AND LATTICE EXAMPLES

beyond surface 5, element (-1,0,0) beyond surface 6, (0,1,0) beyond surface 7, etc. Cell 6 is filled by universe 3, which consists of two cells: cell 8 inside the ellipsoid and cell 9 outside the ellipsoid.

When a lattice cell is defined with a macrobody, the lattice element indexing is somewhat predetermined. The first, third and fifth facets are used to define the direction of increasing indices. For the RPP, the second index increases in the positive y direction and the third index increases in the positive z direction. For the BOX, the order of defining the three vectors will determine the axis each index will increase in a positive direction.

Cell 3 is the top left-hand quarter of the sphere; cell 4 is the top right-hand quarter. Both are filled by universe 2. Both FILL entries are followed by a transformation. The interorigin vector portion of the transformation is between the origin of the filled cell and the origin of the filling universe, with the universe considered to be in the auxiliary coordinate system. The (0,0,0) lattice element is located around the auxiliary origin and the lattice elements are identified by the ordering of the surfaces describing cell 7. The skewed appearance is caused by the rotation part of the transformation.

The source is centered at (0,-5,0) (at the center of cell 1). It is a volumetric source filling cell 1, and the probability of a particle being emitted at a given radius is given by the power law function. For RAD the exponent defaults to 2, so the probability increases as the square of the radius, resulting in a uniform volumetric distribution.

example 4

```
1 1 -.6 -1 imp:n=1
2 0 1 -2 -4 fill=1 (-6 -6.5 0) imp:n=1
3 0 2 -3 -4 *fill=2 (-7 5 0 30 60 90 120 30 90) imp:n=1
4 0 2 3 -4 *fill=2 (4 8 0 15 105 90 75 15 90) imp:n=1
5 0 4 imp:n=1
6 0 -5 6 -$7 8 -9 10 fill=3 u=1 lat=1 imp:n=1
7 3 -2.7 -11 12 -13 14 -15 16 u=2 lat=1 imp:n=1
8 2 -.8 -17 u=3
9 0 17 u=3

1 sy -5 3
2 py 0
3 px 0
4 so 15
5 px 1.5
6 px -1.5
7 py 1
8 py -1
9 pz 3
```

**CHAPTER 4**  
**REPEATED STRUCTURE AND LATTICE EXAMPLES**

```
10 -3
11 p 1 -.5 0 1.3
12 p 1 -.5 0 -1.3
13 py .5
14 py -.5
15 pz 3
16 pz -3
17 sq 1 2 0 0 0 0 -1 .2 0 0

sdef pos 0 -5 0 erg d1 rad d2
si1 0 10
spl 0 1
si2 3
sp2 -21
e0 1 2 3 4 5 6 7 8 9 10 11 12
f2:n 3
sd2 1
f4:n 8 9
sd4 1 1
m1 4009 1
m2 6000 1
m3 13027 1
nps 100000
print
dbcn 0 0 1 4
```

**CHAPTER 4**  
**REPEATED STRUCTURE AND LATTICE EXAMPLES**

Example 5:

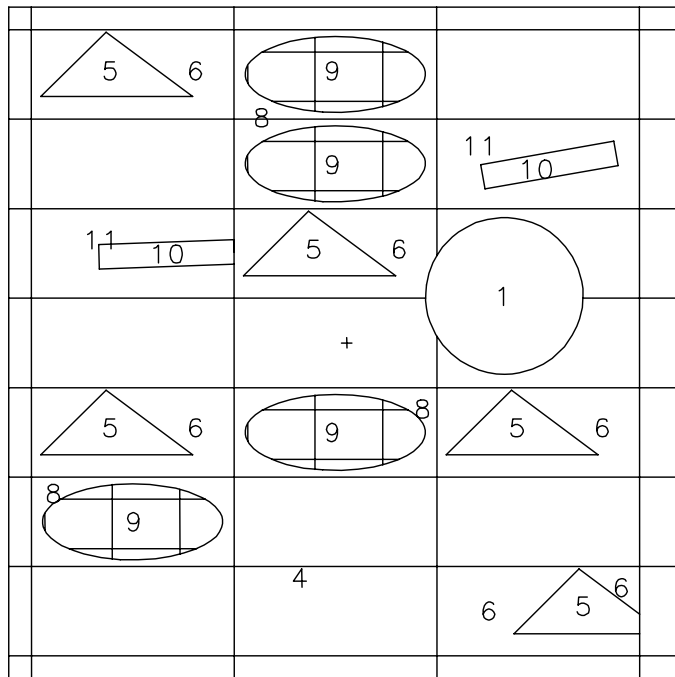

This example illustrates a more complicated lattice geometry and uses the FILL card followed by the array specification. It builds on the expertise from example 4. There are three “main” cells: cell 1 is inside surface 5, cell 3 is the outside world, and cell 2 is the large square (excluding cell 1) that is filled with a lattice, some of whose elements are filled with 3 different universes.

Universe 1 is a hexahedral lattice cell infinite in the z direction. Looking at the FILL parameters, we see that the lattice has five elements in the first direction numbered from -2 to 2, nine elements in the second direction numbered from -4 to 4 and one element in the third direction. The remaining entries on the card are the array that identifies what universe is in each element, starting in the lower left hand corner with (-2,-4,0), (-1,-4,0), (0,-4,0), etc. An array entry, in this case 1, the same as the number of the universe of the lattice means that element is filled by the material specified for the lattice cell itself. Element (1,-3,0) is filled by universe 2, which is located within the element in accordance with the transformation defined on the TR3 card. Element (-1,-2,0) is filled by universe 3. Cell 7, part of universe 3, is filled by universe 5, which is also a lattice. Note the use of the X card to describe surface 13. The quadratic surface, which is symmetric about the x-axis, is defined by specifying three coordinate pairs on the surface.

The source is a volumetric source of radius 3.6 which is centered in and completely surrounds cell 1. CEL rejection is used to uniformly sample throughout the cell. That is, the source is sampled uniformly in volume and any points outside cell 1 are rejected. The same effect could have been

**CHAPTER 4**  
**REPEATED STRUCTURE AND LATTICE EXAMPLES**

achieved using cookie-cutter rejection. The PRINT card results in a full output print, and the VOL card sets the volumes of all the cells to unity.

example 5

```

1      1  -.6 -5 imp:n=1
2      0 -1 2 -3 4 5 -22 23 imp:n=1 fill=1
3      0 1:-2:3:-4:22:-23 imp:n=0
4      2  -.8 -6 7 -8 9 imp:n=1 lat=1 u=1
      fill=-2:2 -4:4 0:0 1 1 1 1 1 1 1 1 2(3) 1 1 3 1 1 1
      1 2 3 2 1 1 1 1 1 1 1 4(2) 2 1 1 1 1 3 4(1) 1
      1 2 3 1 1 1 1 1 1 1
5      3  -.5 -11 10 12 imp:n=1 u=2
6      4  -.4 11:-10:-12 imp:n=1 u=2
7      0 -13 imp:n=1 u=3 fill=5
8      3  -.5 13 imp:n=1 u=3
9      4  -.4 -14 15 -16 17 imp:n=1 lat=1 u=5
10     3  -.5 -18 19 -20 21 imp:n=1 u=4
11     4  -.4 18:-19:20:-21 imp:n=1 u=4

1      px  15
2      px -15
3      py  15
4      py -15
5      s   7 2.1 0 3.5
6      px  4
7      px -5
8      py  2
9      py -2
10     p   .7 -.7 0 -2.5
11     p   .6 .8 0 .5
12     py -1
13     x -4.5 0 -.5 1.7 3.5 0
14     px  1.6
15     px -1.4
16     py  1
17     py -1.2
18     px  3
19     px -3
20     py  .5
21     py -.6
22     pz  6
23     pz -7

```



## CHAPTER 4 REPEATED STRUCTURE AND LATTICE EXAMPLES

```
sdef      erg d1  pos 7 2 0  cel=1  rad d2
si2      3.6
si1      0 10
spl      0 1
f4:n     10
e4       1 3 5 7 9 11
m1       4009 1
m2       6000 1
m3       13027 1
m4       1001 2 8016 1
nps      100000
dbcn     0 0 1 4
*tr      0 0 0 10 80 90 100 10 90
*tr2     1 0 0 2 88 90 92 2 90
tr3      3 0 0
vol      1 10r
print
```

Example 6: This example primarily illustrates a fairly complex source description in a lattice geometry. The geometry consists of two “main” cells, each filled with a different lattice. Cell 2, the left half, is filled with a hexahedral lattice, which is in turn filled with a universe consisting of a cell of rectangular cross section and a surrounding cell. The relation of the origin of the filling universe, 1, to the filled cell, 2, is given by the transformation in parentheses following FILL=1. Cell 3, the right half, is filled with a different hexahedral lattice, in turn filled by universes 4 and 5. Lattice cells must be completely specified by an expanded FILL card if the lattice contains a source (cell 5) or by selecting a coordinate system of a higher level universe (SI7 L -2:4:8). Check print table 110 to see the lattice elements that are being sampled. Become familiar with the geometry before proceeding to the source description.

**CHAPTER 4**  
**REPEATED STRUCTURE AND LATTICE EXAMPLES**

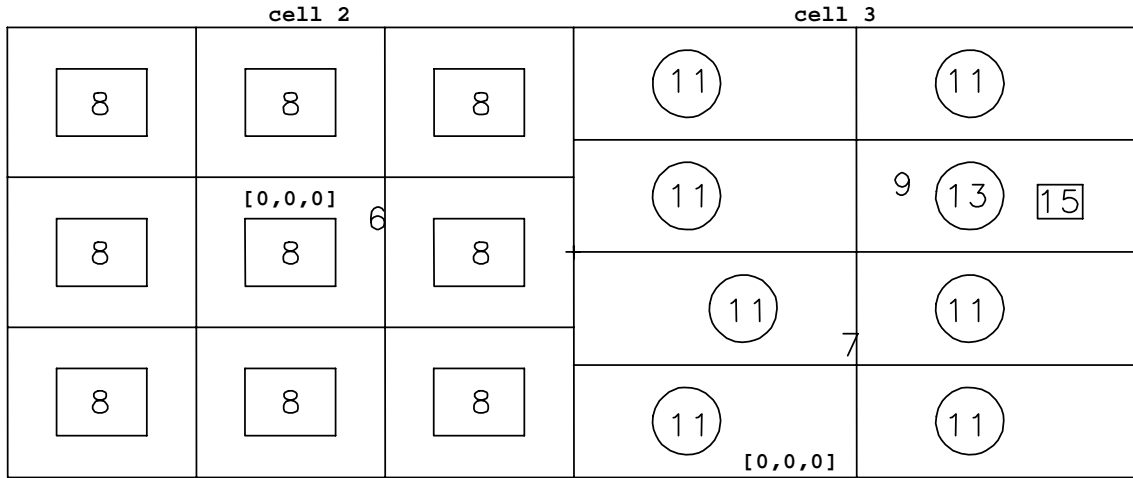

In brief, a volume distributed source located in each of the ten boxes and eight circles (in two dimensions) is desired. The cells involved are given by distribution 6. The S on the SI6 card indicates distribution numbers will follow. The four distributions will describe the cells further. The probabilities for choosing each distribution of cells is given by the SP6 card.

The SI7 card shows the entire path from level 0 to level n for the nine boxes on the left. The expanded FILL notation is used on the cell 4 card to describe which elements of the lattice exist and what universe each one is filled with. All nine are filled by universe 3. SI12 says x is sampled from -4 to 4 and SI14 says y is sampled from -3 to 3. Used together with the expanded FILL, MCNP will sample source points from all nine lattice elements. Without the expanded FILL, only the [0,0,0] element would have source points. Another method would be to use the following input cards:

```

4      0 -11 12 -14 13  imp:n=1  lat=1  u=1 fill=3
si7    1 -2:4:8
si12   -46 -4
si14   -17 17

```

The minus sign by the 2 means the sampled position and direction will be in the coordinate system of the level preceding the entry  $\leq 0$ . There is no preceding entry so they will be in the coordinate system of cell 2. If a point is chosen that is not in cell 8, it is rejected and the variable is resampled.

SI8 describes a path from cell 3 to element (0,0,0) of cell 5 to cell 11, from cell 3 to element (1,0,0) to cell 11, etc. Element (1,2,0) is skipped over and will be treated differently. SI9 is the path to cell 13, the circle in element (1,2,0) and SI10 is the path to cell 15, the box in element (1,2,0). All the other source variables are given as a function of cell and follow explanations given in the manual.

**CHAPTER 4**  
**REPEATED STRUCTURE AND LATTICE EXAMPLES**

example 6

```

1  0  1:$-$3:-4:5:6:$-$7  imp:n=0
2  0 -2 3 4 -5 -6 7  imp:n=1  fill=1 (-25 0 0)
3  0 -1 2 4 -5 -6 7  imp:n=1  fill=2 (0 -20 0)
4  0 -11 12 -14 13  imp:n=1  lat=1  u=1  fill=-1:1 -1:1 0:0 3 8r
5  0 -15 2 -18 17  imp:n=1  lat=1  u=2
   fill=0:1 0:3 0:0 4 4 4(5 0 0) 4 4 5 4 4
6  1 -.9 21:-22:-23:24  imp:n=1  u=3
7  1 -.9 19  imp:n=1  u=4
8  2 -18 -21 22 23 -24  imp:n=1  u=3
9  1 -.9 20(31:-32:-33:34)  imp:n=1  u=5
11 2 -18 -19  imp:n=1  u=4
13 2 -18 -20  imp:n=1  u=5
15 2 -18 -31 32 33 -34  imp:n=1  u=5

1  px 50
2  px 0
3  px -50
4  py -20
5  py 20
6  pz 60
7  pz -60
11 px 8.334
12 px -8.334
13 py -6.67
14 py 6.67
15 px 25
17 py 0
18 py 10
19 c/z 10 5 3
20 c/z 10 5 3
21 px 4
22 px -4
23 py -3
24 py 3
31 px 20
32 px 16
33 py 3
34 py 6

m1 6000 .4 8016 .2 11023 .2 29000 .2
m2 92238 .98 92235 .02
sdef erg fcel d1 cel d6 x fcel d11 y fcel d13 z fcel d15

```

**CHAPTER 4**  
**REPEATED STRUCTURE AND LATTICE EXAMPLES**

```

rad fcel d17  ext fcel d19  pos fcel d21  axs fcel d23
ds1  s d2 d3 d4 d5
sp2  -2 1.2
sp3  -2 1.3
sp4  -2 1.4
sp5  -2 1.42
si6  s d7 d8 d9 d10
sp6  .65 .2 .1 .05
si7  1 2:4:8
sp7  1
si8  1 3:5(0 0 0):11 3:5(1 0 0):11 3:5(0 1 0):11 3:5(1 1 0):11
      3:5(0 2 0):11 3:5(0 3 0):11 3:5(1 3 0):11
sp8  1 1 1 1 1 1 1
si9  1 3:5(1 2 0):13
sp9  1
si10 1 3:5(1 2 0):15
sp10 1
ds11 s d12 0 0 d25
si12 -4 4
sp12 0 1
ds13 s d14 0 0 d26
si14 -3 3
sp14 0 1
ds15 s d16 0 0 d16
si16 -60 60
sp16 0 1
ds17 s 0 d18 d18 0
si18 0 3
sp18 -21 1
ds19 s 0 d20 d20 0
si20 -60 60
sp20 0 1
ds21 s 0 d22 d22 0
si22 1 10 5 0
sp22 1
ds23 s 0 d24 d24 0
si24 1 0 0 1
sp24 1
si25 16 20
sp25 0 1
si26 3 6
sp26 0 1

```

## CHAPTER 4 REPEATED STRUCTURE AND LATTICE EXAMPLES

```
f2:n 1
e2 .1 1 20
f6:n 2 4 6 8 3 5 7 9 11 13 15
sd6 1 1 1 1 1 1 1 1 1 1 1
print
nps 5000
```

### Example 7:

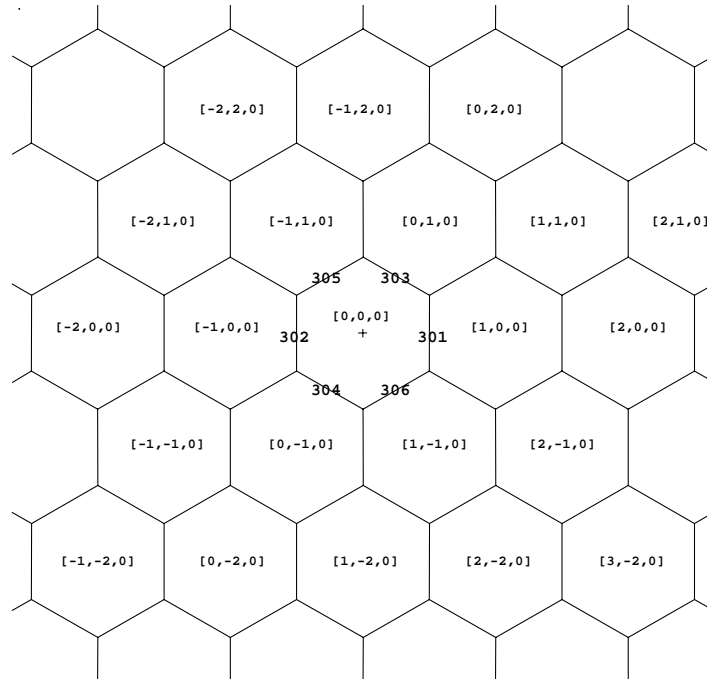

This example illustrates a hexagonal prism lattice and shows how the order of specification of the surfaces on a cell card identifies the lattice elements beyond each surface. The (0,0,0) element is the space described by the surfaces on the cell card, perhaps influenced by a TRCL entry. The user chooses where the (0,0,0) element will be. The user chooses the location of the (1,0,0) element—it is beyond the first surface entered on the cell card. The (-1,0,0) element **MUST** be in the opposite direction from (1,0,0) and **MUST** be beyond the second surface listed. The user then chooses where the (0,1,0) element will be—it must be adjacent to the (1,0,0) element—and that surface is listed next. The (0,-1,0) element **MUST** be diagonally opposite from (0,1,0) and is listed fourth. The fifth and sixth elements are defined based on the other four and must be listed in the correct order: (-1,1,0) and (1,-1,0). Pairs can be picked in any order but the pattern must be adhered to once set. Illustrated is one pattern that could be selected and shows how the numbering of elements in this example progresses out from the center.

```
hexagonal prism lattice
1 0 -1 -19 29 fill=1 imp:n=1
2 0 -301 302 -303 305 -304 306 lat=2 u=1 imp:n=1
```

```

3      0 1:19:-29 imp:n=0

1      cz 20
19     pz 31.75
29     pz -31.75
301    px 1
302    px -1
303    p  1 1.7320508076 0 2
304    p -1 1.7320508076 0 2
305    p  1 1.7320508076 0 -2
306    p -1 1.7320508076 0 -2

sdef
fl:n   1
nps    2000

```

One of the most powerful uses of macrobodies is for the specification of hexagonal prisms. The example above can be simplified by using the RHP (also called HEX) macrobody as follows:

```

hexagonal prism lattice
C Cell Cards
1 0 -2          fill=1          imp:n=1
2 0 -1          lat=2 u=1      imp:n=1
3 0 2          imp:n=0

C Surface Cards
1 rhp 0 0 -31.75  0 0 63.5  2 0 0
2 rcc 0 0 -31.75  0 0 63   20

```

## CHAPTER 4 REPEATED STRUCTURE AND LATTICE EXAMPLES

### Example 8:

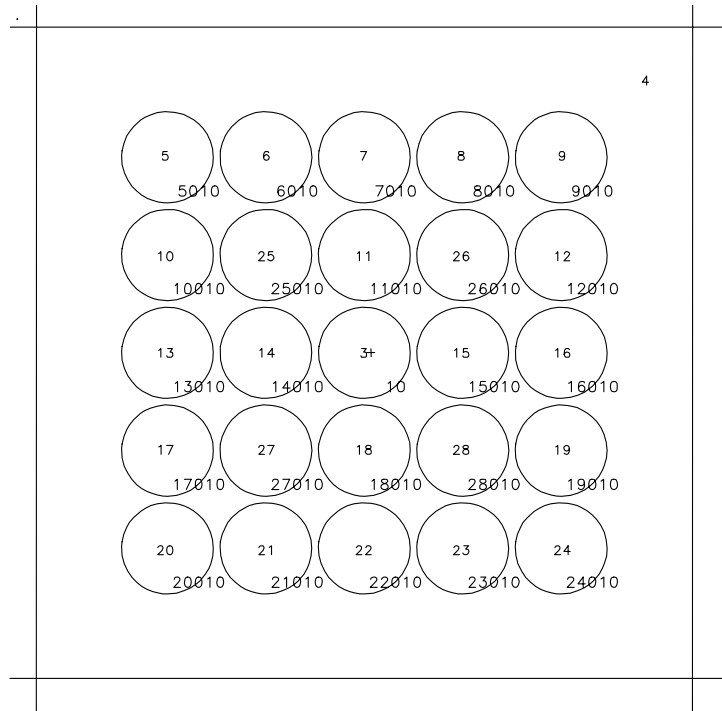

This example shows how the LIKE m BUT and TRCL cards can be used to create an array of nonidentical objects within each cell of a lattice. Only one lattice element is shown in the plot above. A lattice of hexahedral subassemblies, each holding an array of 25 cylindrical rods, is contained within a cylindrical cell. Cell 1 is the space inside the large cylinder and is filled with universe 1. Cell 2 is the only cell in universe 1 and is the hexahedral lattice that fills cell 1. The lattice is a 7x7x1 array, indicated by the array indices on the FILL card, and is filled either by universe 2 or by itself, universe 1. Cell 3, a fuel rod, is in universe 2 and is the space inside the cylindrical rod. The other fuel cells, 5–24, are like cell 3 but at different x,y locations. The material in these 21 fuel cells is slightly enriched uranium. Cells 25–28 are control rods. Cell 25 is like 3 but the material is changed to cadmium, and the density and the x,y location are different. Cells 26–28 are like cell 25 but at different x,y locations. Cell 4 is also in universe 2 and is the space outside all 25 rods. To describe cell 4, each cell number is complimented. Notice in the plot that all the surfaces except for the center one have a new predictable surface number—1000 \* cell no + surface no. These numbers could be used in the description of cell 4 if you wanted.

The KCODE and KSRC cards specify the criticality source used in calculating  $k_{eff}$ . There are 1000 particles per cycle, the initial guess for  $k_{eff}$  is 1, 5 cycles are skipped before the tally accumulation begins, and a total of 10 cycles is run.

example of pwrlat

```
1 0 -1 -19 29 fill=1 imp:n=1
2 2 -1 -301 302 -303 304 lat=1 u=1 imp:n=1 fill=-3:3 -3:3 0:0
```

**CHAPTER 4**  
**REPEATED STRUCTURE AND LATTICE EXAMPLES**

```

1 1 1 1 1 1 1 1 2 2 2 1 1 1 2 2 2 2 2 1 1 2 2 2 2 2 1
1 2 2 2 2 2 1 1 1 2 2 2 1 1 1 1 1 1 1 1 1 1 1 1 1 1
3 1 -18 -10 u=2 imp:n=1
4 2 -1 #3 #5 #6 #7 #8 #9 #10 #11 #12 #13 #14 #15 #16 #17 #18
  #19 #20 #21 #22 #23 #24 #25 #26 #27 #28 imp:n=1 u=2
5 like 3 but trcl=(-6 6 0)
6 like 3 but trcl=(-3 6 0)
7 like 3 but trcl=(0 6 0)
8 like 3 but trcl=(3 6 0)
9 like 3 but trcl=(6 6 0)
10 like 3 but trcl=(-6 3 0)
11 like 3 but trcl=(0 3 0)
12 like 3 but trcl=(6 3 0)
13 like 3 but trcl=(-6 0 0)
14 like 3 but trcl=(-3 0 0)
15 like 3 but trcl=(3 0 0)
16 like 3 but trcl=(6 0 0)
17 like 3 but trcl=(-6 -3 0)
18 like 3 but trcl=(0 -3 0)
19 like 3 but trcl=(6 -3 0)
20 like 3 but trcl=(-6 -6 0)
21 like 3 but trcl=(-3 -6 0)
22 like 3 but trcl=(0 -6 0)
23 like 3 but trcl=(3 -6 0)
24 like 3 but trcl=(6 -6 0)
25 like 3 mat=3 rho=-9 trcl=(-3 3 0)
26 like 25 but trcl=(3 3 0)
27 like 25 but trcl=(-3 -3 0)
28 like 25 but trcl=(3 -3 0)
50 0 1:19:-29 imp:n=0

1 cz 60
10 cz 1.4
19 pz 60
29 pz -60
301 px 10
302 px -10
303 py 10
304 py -10

kcode 1000 1 5 10
ksrc 0 0 0

```



## CHAPTER 4 TALLY EXAMPLES

```
m1  92235 .02 92238 .98
m2  1001 2 8016 1
m3  48000 1
```

### IV. TALLY EXAMPLES

This section contains examples of the FMn, FSn, and FTn tally cards, a complicated repeated structures/lattice example, and the TALLYX subroutine. Refer also to page 3–75 for the FMn card, to page 3–83 for the FSn card, to page 3–93 for the FTn card, to page 3–69 for the basic repeated structure/lattice tally, and to page 3–87 for TALLYX before trying to understand these examples.

#### A. FMn Examples (Simple Form)

Example 1: Consider the following input cards.

```
F4:N      10
FM4       0.04786   999 102
M999      92238.13  1
```

The F4 neutron tally is the track length estimate of the average fluence in cell 10. Material 999 is  $^{238}\text{U}$  with an atomic fraction of 100%.

$C = 0.04786$       normalization factor (such as atom/barn cm)  
 $M = 999$             material number for  $^{238}\text{U}$  as defined on the material card  
                          (with an atom density of 0.04786 atom/barn·cm)  
 $R_1 = 102$           ENDF reaction number for radiative capture  
                          cross section (microscopic)

The average fluence is multiplied by the microscopic ( $n,\gamma$ ) cross section of  $^{238}\text{U}$  (with an atomic fraction of 1.0) and then by the constant 0.04786 (atom/barn·cm). Thus the tally 4 printout will indicate the number of  $^{239}\text{U}$  atoms/cm<sup>3</sup> produced as a result of ( $n,\gamma$ ) capture with  $^{238}\text{U}$ .

Standard F6 and F7 tallies can be duplicated by F4 tallies with appropriate FM4 cards. The FM4 card to duplicate F6 is

```
FM4      C M 1 -4.
```

For F7 it is

```
FM4      C M -6 -8.
```

$C = 10^{-24}$  x number of atoms per gram  
 $R_1 = 1$       ENDF reaction number for total cross section (barns)  
 $R_2 = -4$      reaction number for average heating number (MeV/collision)  
 $R_1 = -6$      reaction number for total fission cross section (barns)  
 $R_2 = -8$      reaction number for fission Q (MeV/fission)

This technique applied to F2 tallies can be used to estimate the average heating over a surface rather than over a volume. It provides the surface equivalents of F6 and F7 tallies, which are not available as standard tallies in MCNP.

Example 2: Consider a point detector.

F25:N	0	0	0	0
FM25	0.00253	1001	-6	-8
M1001	92238.60	.9	92235.60	.1

This F25 neutron tally is the fission heating per unit volume of material 1001 at the origin. Material 1001 does not actually have to be in a cell at the origin. The FM25 card constants are:

$C$	= 0.00253	atoms per barn-cm (atomic density) of material 1001
$M$	= 1001	material number for material being heated
$R_1$	= -6	reaction number for total fission cross section (barn)
$R_2$	= -8	reaction number for fission Q (MeV/fission)

Example 3: Lifetime calculation

F4:N	1	
SD4	1	
FM4	(-1 1 16:17)	\$ bin 1 = (n,xn) reaction rate
	(-1 1 -2)	\$ bin 2 = capture (n,0n) reaction rate
	(-1 1 -6)	\$ bin 3 = fission reaction rate
	(-1 -2)	\$ bin 4 = prompt removal lifetime=flux/velocity
M1	92235 -94.73 92238 -5.27	

This F4 neutron flux tally from a Godiva criticality problem is multiplied by four FM bins and will generate four separate tally quantities. The user can divide bins 1, 2, and 3 by bin 4 to obtain the (n,xn) lifetime, the (n,0n) lifetime, and the (n,f) lifetime, respectively. The FM4 card entries are:

$C$	= -1	multiply by atomic density of material 1
$M$	= 1	material number on material card
$R_1$	= 16:17	reaction number for (n,2n) cross section <i>plus</i> reaction number for (n,3n) cross section
$R_2$	= -2	reaction number for capture cross section
$R_3$	= -6	reaction number for total fission cross section
	= 1 -2	prompt removal lifetime = flux/velocity = time integral of population

More examples: (Remember  $C = -1 = \rho$  for type 4 tally)

F5:N	0	0	0	0	Neutron heating per cm <sup>3</sup> with an atom density of
FM5	$\rho$	$M$	1	-4	$\rho$ of material $M$ at a point detector

**CHAPTER 4**  
**TALLY EXAMPLES**

F5Y:P	10	5	0		Photon heating per cm <sup>3</sup> of material <i>M</i>
FM5	$\rho$	<i>M</i>	-5	-6	with an atom density $\rho$ at a ring detector
F1:N	1	2	3		Number of neutron tracks crossing surfaces 1, 2, and 3
FM1	1	0			per neutron started
F35:P	0	0	0	0	Number of photon collisions per source particle
FM35	1	0			that contribute to point detector
M99	3007	1			<sup>7</sup> Li tritium production per cm <sup>3</sup> in cell 10
F4:N	10				
FM4	-1	99	91		
F104:N	8				Number of reactions per cm <sup>3</sup> of type <i>R</i> in cell 8
FM104	-1	<i>M</i>	<i>R</i>		of material <i>M</i> of atom density $\rho$

**B. FMn Examples (General Form)**

Remember that the hierarchy of operation is multiply first and then add and that this hierarchy can not be superseded by the use of parentheses.

Example 1:

F4:N	1				
FM4	( $\rho$ 1 (1 -4)(-2))	( $\rho$ 1 1)			where $C = \rho =$ atomic density (atom/barn-cm)
M1	6012.10	1			

In this example there are three different tallies, namely

- (a)  $\rho$  1 1 -4
- (b)  $\rho$  1 -2
- (c)  $\rho$  1 1

Thus tally (a) will yield the neutron heating in MeV/cm<sup>3</sup> from <sup>12</sup>C in cell 1. The advantage in performing the multiplication 1 -4 in tally (a) is that the correct statistics are determined for the desired product. This would not be true if tally (a) were to be done as two separate tallies and the product formed by hand after the calculation.

Example 2:

F4:N	1				
FM4	(0.04635 1 (105:91))				
M1	3006.50	0.0742	3007.50	0.9258	

In this example we obtain the total tritium production per  $\text{cm}^3$  from natural lithium (ENDF/B-V evaluation) in cell 1. The constant C on the FM4 card is the atomic density of natural lithium. A subtle point is that the R = 105 reaction number contains the reaction data for just the  ${}^6\text{Li}$  reaction and R = 91 contains the reaction data for the  ${}^7\text{Li}$  reaction (p.524 Appendix G). However, this examples uses both sets of reaction data in the FM4 card to calculate the tritium production in a media composed of both  ${}^6\text{Li}$  and  ${}^7\text{Li}$ . Thus, four calculations are carried out (two for  ${}^6\text{Li}$  using R = 91,105, and two for  ${}^7\text{Li}$  using R = 91,105). Note that two of these calculations ( ${}^6\text{Li}$  with R = 91, and  ${}^7\text{Li}$  with R = 105) will contribute nothing to the total tritium production.

Example 3: Suppose we have three reactions— $R_1$ ,  $R_2$ , and  $R_3$ —and wish to add  $R_2$  and  $R_3$  and multiply the result by  $R_1$ . The following would *NOT* be valid: FMn (C m  $R_1$  ( $R_2$ : $R_3$ )). The correct card is: FMn (C m ( $R_1$   $R_2$ :  $R_1$   $R_3$ )).

### C. FSn Examples

The FSn card allows you to subdivide your tally into geometry segments, avoiding overspecifying the problem geometry with unnecessary cells.

The entries on the FS card are the names and senses of surfaces that define how to segment any surface or cell tally.

Example 1: Consider a 1-MeV point isotropic source at the center of a 2 cm cube of carbon. We wish to calculate the flux through a 1- $\text{cm}^2$  window in the center of one face on the cube. The input file calculating the flux across one entire face is shown in Figure 4.18.

```

EXAMPLE 1, SIMPLE CUBE
1      1 -2.22  1 2 -3 -4 -5 6  IMP:N=1
2      0      #1                IMP:N=0

1      PY 0
2      PZ -1
3      PY 2
4      PZ 1
5      PX 1
6      PX -1

SDEF  POS = 0 1 0  ERG = 1
M1    6012.60 -1
F2:N  3
    
```

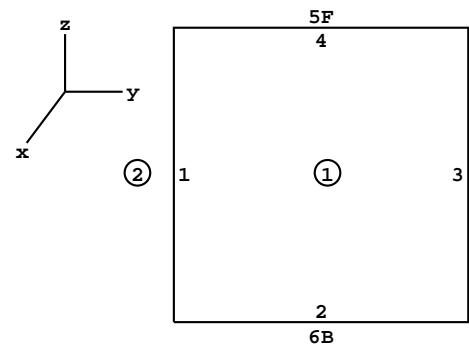

**Figure 4-18.**

The FS card retains the simple cube geometry and four more surface cards are required,

**CHAPTER 4**  
**TALLY EXAMPLES**

```

7      PX  .5
8      PX -1.5
9      PZ  .5
10     PZ -1.5

```

```

FS2   7  -10 -8  9

```

The four segmenting surface cards are listed with the other surface cards, but they are not part of the actual geometry and hence do not complicate the cell-surface relationships.

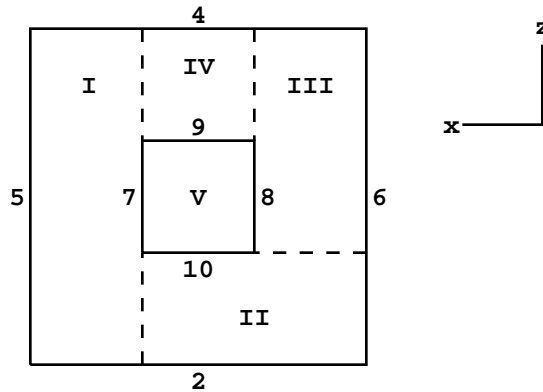

**Figure 4-19.**

The F2 tally is subdivided into five separate tallies as shown in Figure 4.19: (1) the first is the flux of particles crossing surface 3 but with a positive sense to surface 7; (2) the second is the remaining flux with negative sense to surface 7 crossing surface 3 but with a negative sense to surface 10; (3) the third is the remaining flux (negative sense to 7 and positive sense to 10) crossing 3 but with a negative sense to 8; (4) the remaining flux with positive sense to 9; and (5) everything else. In this example, the desired flux in the window is in the fifth subtally—the “everything else” portion.

The FS segmenting card could have been set up other ways. For example:

```

FS2   -10  7  9  -8  and
FS2   -8   9 -10  7

```

Each works, but the order of the subtallies is changed. A way to avoid the five subtallies and to get only the window of interest is to use the TALLYX subroutine described later.

Example 2: Consider a source at the center of a 10-cm radius sphere called cell 1. We want to determine the fission heating in a segment of the sphere defined by the intersection of the 10-cm sphere, an 8-cm inner sphere, and a 20° cone whose vertex is at the source and is about the Y-axis. This is accomplished by using

```

F7:N      1
FS7       -2 -3

```

where surface 2 is the 8-cm surface and surface 3 is the cone. This breaks the F7 tally up into three portions: (1) the heating inside the 8-cm sphere; (2) the heating outside the 8-cm sphere but within the cone—this is the desired portion; and (3) everything else, which is a 2-cm shell just inside the 10-cm sphere but outside the cone.

**D. FTn Examples**

Example 1: Consider the following input cards.

```
F1:N    2
FT1     FRV  V1 V2 V3
```

The FTn card is the special treatment for tallies card. Various tally treatments are available for certain specific tally requirements. The FTn tally with the FRV card used in conjunction with tally type 1 will redefine the vector normal to the tally surface. In this case, the current over surface 2 (tally type 1) uses the vector V as its reference vector for getting the cosine for binning.

Example 2:

```
F5:P    4
FT5     ICD
FU5     1  3
```

In this example the photon flux at detector 5 is being tallied. However, only the contributions to the detector tally from cells 1 and 3 are of interest. The ICD keyword allows the user to create a separate bin for each cell, and only contributions from one of the specified cells are scored. The FUn card specifies the cells from which tallies are to be made, but TALLYX is not called.

Example 3: When keeping track of charged particle current across a surface, it is sometimes desirable to track both positive and negative score contributions, applicable in cases that include electrons and positrons. Consider a photon source that is enclosed in a spherical shell of lead. If a surface current tally is taken over the sphere and it is desirable to tally both the positron and electron current separately, then the special treatment card option is invoked.

```
1    1 -.001124  -11    imp:e=1  imp:p=1
2    2 -11.0     11 -21    imp:e=1  imp:p=1
3    0           21     imp:e=0  imp:p=0

11   so 30
21   so 32

m1   6012 .000125  7014 .6869  8016 .301248  18040 .011717
m2   82000 1.
mode  p e
sdef  pos = 0. 0. 0.  erg = 2.5
f1:e  21
ft1   elc 2
f2:p  21
```

## CHAPTER 4

### TALLY EXAMPLES

```
e2    1e-3 1e-2 0.1 0.5 1.0 1.5 2.0 2.5 C
nps   10000
```

The input deck shown above models a sphere filled with dry air surrounded by a spherical shell of lead. The centrally located source emits 2.5 MeV photons that travel through the air into the lead shell. The F1 surface current tally has been modified with the ELC special tally option. The parameter value of 2 that follows the ELC keyword specifies that positrons and electrons be placed into separate tally user bins. Once this option has been invoked, the user can inspect the output tally bins for the respective scoring of either particle.

The F2 tally scores photon flux crossing surface 21, scored into energy bins defined on the E2 card. The C at the end of the energy bin card indicates that the bins are cumulative. Therefore the bin with an upper limit of 1 MeV would contain scores from particles that cross surface 21 with energy less than or equal to 1 MeV.

Example 4: Consider the following two point sources, each with a different energy distribution:

```
sdef      pos=d1  erg=fpos d2
si1       L  5 3 6   75 3 6
sp1       .3 .7
ds2       S  3  4
si3       H  2 10 14
sp3       D  0  1  2
si4       H  .5 2 8
sp4       D  0  3  1
f2:n      2
ft2       scd
fu2       3  4
```

The SCD option causes tallies to be binned according to which source distribution was sampled. The FUn card is used to list the distribution numbers of interest. Thus, the tallies in this example are placed in one of two bins, depending on which of the two sources emitted the particle. The two sources may represent two nuclides with different energy distributions, for instance, with the use of the SCD option allowing the user to determine each nuclide's contribution to the final tally.

#### ***E. Repeated Structure/Lattice Tally Example***

An explanation of the basic repeated structure/lattice tally format can be found on page 3–69 in Chapter 3. The example shown here illustrates more complex uses. Figures 4.20(a–f) indicate the tally regions for each tally line. The number of bins generated by MCNP is shown at the end of each tally line following the \$.

example 1 - repeated structure lattice tally example

```

1 0      -1 -2 3 13 fill=4
2 0      -1 -2 3 -13 fill=1
3 0      -4 5 -6 7 u=1 lat=1
          fill=-2:2 -2:0 0:0  1 1 3 1 1  1 3 2 3 1  3 2 3 2 3
4 0      -8 9 -10 11 u=2 fill=3 lat=1
5 1 -0.1 -12 u=3
6 0      12 u=3
7 0      -14 -2 3 u=4 fill=3 trcl=(-60 40 0)
8 like 7 but trcl=(-30 40 0)
9 like 7 but trcl=(0 40 0)
10 like 7 but trcl=(30 40 0)
11 like 7 but trcl=(60 40 0)
12 0      #7 #8 #9 #10 #11 u=4
13 0      1:2:-3

```

```

1 cz 100
2 pz 100
3 pz -100
4 px 20
5 px -20
6 py 20
7 py -20
8 px 10
9 px -10
10 py 10
11 py -10
12 cz 5
13 py 19.9
14 cz 10

```

```

f4:n    5 6 (5 6 3)                                $ 3 bins
        (5<3) (5<(3[-2:2 -2:0 0:0]))                $ 2 bins
        (5<(7 8 9 10 11)) (5<7 8 9 10 11<1) (5<1)  $ 7 bins
        ((5 6)<3[0 -1 0]) ((5 6)<3[0:0 -1:-1 0:0]) ((5 6)<3[8]) $ 3 bins
        (5<(4[0 0 0]3[8]))(5<4[0 0 0]<3[8])
          (3<(3[1]3[2]3[4]3[5]3[6]3[10]))          $ 3 bins
        5<u=3)                                     $ 12 bins

```



**CHAPTER 4  
TALLY EXAMPLES**

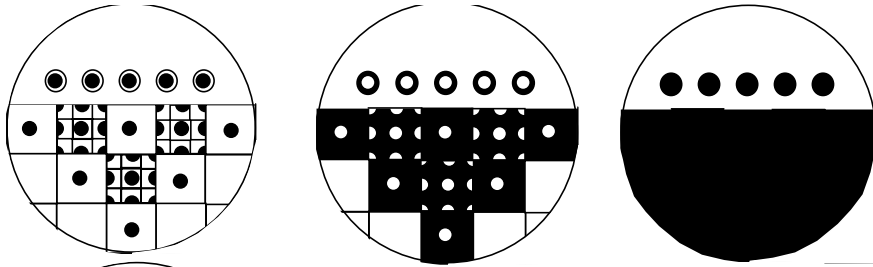

Fig 4.20a

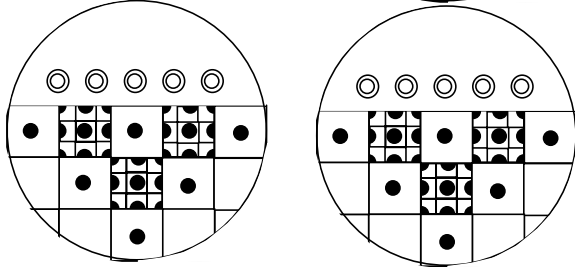

Fig 4.20b

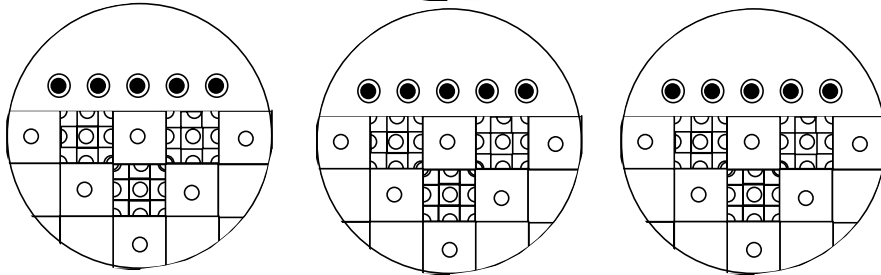

Fig 4.20c

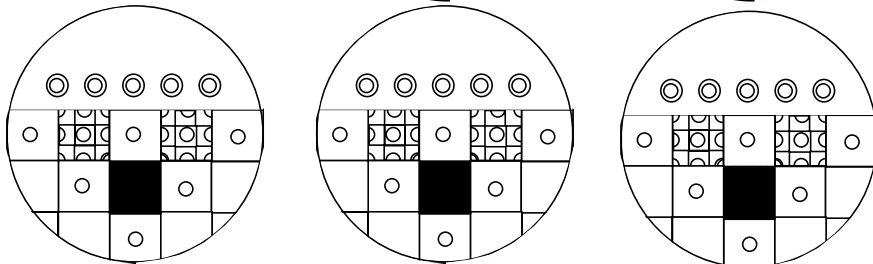

Fig 4.20d

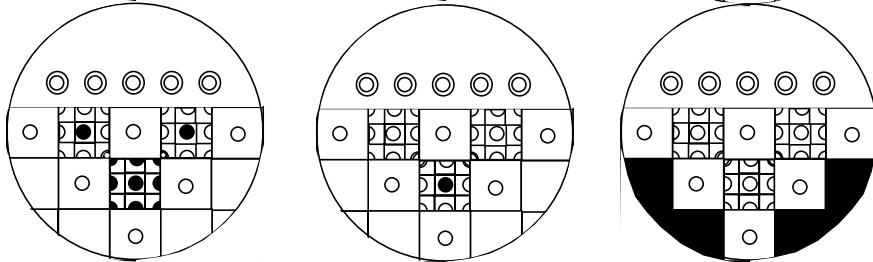

Fig 4.20e

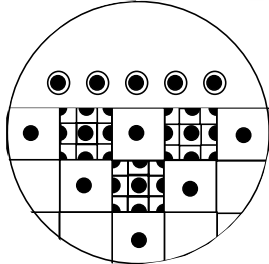

Fig 4.20f

**Figure 4-20.**

*Tally line 1:* This first line creates three tally output bins: cell 5, cell 6, and the union of cells 5, 6, and 3, indicated in Figure 4.20a. Notice that cell 3 is filled entirely by cells 5 and 6. Cell 5 plus cell 6 equals cell 3. If a particle is tallied in cell 5 and tallied in cell 3, it will be tallied twice in the bin (5 6 3). **CAUTION:** A true union IS performed when first level cells overlap (or fill) another cell. This probably is NOT a tally you often want. If an average of cell 3 and region (5 6) outside cell 3 is desired, separate bins must be defined and properly combined using correct volume weighting.

*Tally line 2:* These two input tally bins result in identical output tallies and demonstrate the use of lattice index brackets that include all existing lattice elements, thereby making the two tallies equivalent. The simpler format will execute faster. Tally region shown in Fig. 4.20b.

*Tally line 3:* This line illustrates omission of geometry levels and a single output bin vs. multiple bins. All three input bins tally cell 5 within cells 7 through 11. The second bin specifies the entire path explicitly. Because the only place cell 5 exists within cell 1 is in cells 7–11, the 7–11 specification can be omitted, as in the third input bin. In the second input bin, the parentheses around cells 7–11 are omitted, creating multiple output bins. Five tally bins are produced: (5<7<1), (5<8<1), (5<9<1), (5<10<1), and (5<11<1). The sum of these five bins should equal the tally in the first and last output bins on this line. Tally region shown in Fig. 4.20c.

*Tally line 4:* This line illustrates the union of multiple tally cells, (5 6), and various ways of specifying lattice index data. The three input tally bins create three output tally bins with identical values because the three different lattice descriptions refer to the same lattice element, the eighth entry on the FILL array. If the parentheses around (5 6) were removed, two output bins would be created for each input bin, namely (5<3[0 -1 0]) and (6<3[0 -1 0]), etc. Tally region shown in Fig. 4.20d.

*Tally line 5:* This line illustrates tallies in overlapping regions in repeated structures in a lattice and a tally in lattice elements filled with themselves. Three tally output bins are produced. In the first input bin, a particle is tallied only once when it is in cell 5 and in 4[0 0 0] and in 3[0 -1 0]. Figure 4.20f shows all the cell 5's included in this tally bin. This tally is probably more useful than the overlapping regions in tally line 1. Input bin two demonstrates a tally for a nested lattice. A tally is made when a particle is in cell 5 and in cell 4, element [0 0 0] and in cell 3, element [0 -1 0]. Note that 3[0 -1 0] is indeed filled with cell 4 (u=2). If that were not true, a zero tally would result in this bin. The final input tally bin demonstrated a tally in lattice elements that are filled with their own universe number. This method is the only way to tally in these elements separate from the rest of cell 3. Tally region shown in Fig. 4.20e.

*Tally line 6:* This line illustrates the universe format. The single input bin includes all possible chains involving cell 5. Because u=3 is not within parentheses, the input is expanded into twelve output bins: (5<3[3]), etc. The format 3[3] indicates the third lattice element of cell 3 as entered on the cell 3 FILL array. Note that the third element is filled by universe 3, consisting of cells 5 and 6. Tally region shown in Fig. 4.20f.

## CHAPTER 4

### TALLY EXAMPLES

#### F. TALLYX Subroutine Examples

An explanation of the TALLYX subroutine arguments can be found on page 3–87 in Chapter 3. Only examples illustrating some uses of TALLYX will be found here.

Example 1: In the example of the FS<sub>n</sub> card to get the flux through a window on the face of a cube, instead of using the FS2 card, which established five sub tallies, TALLYX could have been used to get only the desired window tally. Two input cards are used:

```
FU2      1
RDUM    -.5 .5 -.5 .5
```

The following subroutine (which is implemented just like a user-provided SOURCE subroutine by replacing lines TX.2 through TX.18) does the job. Note that IB=0 and IBU=1 upon entry into TALLYX.

```
          SUBROUTINE TALLYX(T,IB)
*CALL    CM
          IF(X.LT.RDUM(1).OR.X.GT.RDUM(2))IB = -1
          IF(Z.LT.RDUM(3).OR.Z.GT.RDUM(4))IB = -1
          RETURN
          END
```

The subroutine was generalized a bit by using the RDUM input card, although the card could have been avoided by hard wiring the dimensions of the window into TALLYX.

Example 2: Dump 18 words of the GPBLCM array to a BCD file called UOUT each time a neutron crosses surface 15. The input cards are

```
F2:N      15
FU2       1
FILES     7  UOUT
```

The user-provided subroutine is

```
          SUBROUTINE TALLYX(T,IB)
*CALL    CM
          WRITE(7,20) (GPBLCM(I),I=1,10),NPA,ICL,JSU,IPT,IEX,NODE,IDX,NCP
          20  FORMAT(5E14.6/5E14.6/7I10/2I10)
          RETURN
          END
```

Every time surface 15 is crossed and the F2 tally is scored, TALLYX is called and part of the GPBLCM array is written to the file UOUT. If more discrimination is desired, such as dump the GPBLCM array only for neutrons with energy between 2.5 and 4.5 MeV and crossing surface 15 at less than 30° with respect to the normal (assume surface 15 has been defined by a PY card), add the following two lines before the WRITE statement:

```
IF(VVV.LT.0.866)RETURN
IF(ERG.LT.2.5.OR.ERG.GT.4.5)RETURN
```

To write a binary file, the FILES card entries are 7 UOUT S U and the WRITE statement in TALLYX is unformatted:

```
                SUBROUTINE TALLYX(T,IB)
*CALL          CM
                WRITE(7) (GPBLCM(I),I=1,10),NPA,ICL,JSU,IPT,IEX,NODE,IDX,NCP
                RETURN
                END
```

The advantage of a BCD file is that it is easy to look at and manipulate, but it requires more I/O time and a larger file. A binary file is more compact than a BCD file and requires less I/O time to write; however, it may be more difficult to use.

Example 3: Calculate the number of neutron tracks exiting cell 20 per source neutron. This is also done in Chapter 5 with the TEST1 example using the FMn card. The input cards are

```
F4:N      20
FU4       1
SD4       1
```

and TALLYX becomes

```
                SUBROUTINE TALLYX(T,IB)
*CALL          CM
                T=1.0
                IF(PMF.LT.DLS) IB = -1
                RETURN
                END
```

The quantity T=1.0 is scored every time a track exits cell 20. The variables used in this subroutine, PMF (the distance to collision) and DLS (distance to the boundary), are available to TALLYX from the MCNP COMMON.

## CHAPTER 4

### TALLY EXAMPLES

Example 4: Divide the point detector scores into separate tallies (that is, user bins) depending upon which of the 20 cells in a problem geometry caused the contributions. The input cards are

```
F5:N      0  0  0  0
FU5       1 18I 20
```

and TALLYX is

```
          SUBROUTINE TALLYX(T,IB)
*CALL     CM
          IBU=ICL9
          RETURN
          END
```

The FU5 card establishes 20 separate user bins, one for each cell in the problem. Note the use of the “nI” input format, described in Chapter 3, which creates 18 linear interpolates between 1 and 20. The variable ICL9 contains, for the current history, the number of the cell which produced the original particle.

Example 5: Determine the quantity  $\int \phi(E) f(E) dE$  in cell 14 where  $f(E) = e^{\alpha t}$ . The input cards are

```
F4:N      14
FU4        $\alpha$ 
```

where  $\alpha$  is a numerical value and TALLYX is

```
          SUBROUTINE TALLYX(T,IB)
*CALL     CM
          T=T*EXP(TDS(IPTAL(LIPT+3,1,ITAL)+1)*TME)
          RETURN
          END
```

The FU4 card establishes a single user bin, and the value of  $\alpha$  is stored in  $TDS(IPTAL(LIPT+3,1,ITAL)+1)$  and used for the tally label.

Example 6: Tally the number of neutrons passing through cell 16 which have had 0, 1, 2, 3, or 4 collisions. The input cards are

```
F4:N      16
FU4       0 1 2 3 4
SD4       1
```

and TALLYX is

```

SUBROUTINE TALLYX(T,IB)
*CALL    CM
         IBU=INT(SPARE1)+1
         IF(IBU.GT.5)IB = -1
         T=WGT
         RETURN
         END

```

The subroutine can be generalized by replacing the 5 in the IF statement with IPTAL(LIPT+3, 3, ITAL), which is the number of entries on the FU4 card.

If no tracks were put into the bank (from fission, geometry splitting, etc.), INT(SPARE1) could be replaced by NCH(1), the number of neutron collisions per history. However, to be general, use the quantity SPARE1, which goes into the bank with the rest of the banked track parameters. SPARE1 must be set to 0 when a source particle is started and then incremented at collisions. This is done with the following patch in the STARTP and HSTORY subroutines:

```

*I, SP. 30
    SPARE1=0.
*I, HS. 184
    SPARE1=SPARE1+1.

```

If the IF statement in this TALLYX is omitted, a count will be made of the cases of five or more collisions, and in these cases no score will be tallied but a count will be printed of the times that the tally was unable to be made because IBU was a value where no bin existed.

In the five user bins, T is the number of neutrons per source neutron passing through cell 16 that has undergone 0, 1, 2, 3, or 4 collisions, respectively. Note that the FU4 card has five entries to establish the five user bins and provide labels. Note also that in this example, the neutrons are calculated so that T=T\* renormalization factor (which preserves the weight associated with the tracks), where in Example 3 the neutron tracks are calculated so that T=1. Again the value of SPARE1 is available from COMMON. Finally, note that if SPARE1 > 5 (six or more collisions) no tally is made because IB is set to be less than zero. If an E4 card were added, the neutrons would be tallied as a function of energy for each user bin.

## **V. SOURCE EXAMPLES**

Some examples of the general source are given here to illustrate the power and complexity of this feature. Refer to Chapter 3 for the more complete explanation and other examples.

Example 1:     SDEF  ERG = D1  DIR FERG D2  
                   SUR=1  CEL=2  POS=X Y Z  RAD D5  VEC = U V W  
           SII  H  10<sup>-7</sup>  10<sup>-5</sup>  ... 13.5 14 ... 20  \$ Level 1  
           SP1  D  0    10<sup>-4</sup>  ... 10<sup>-2</sup> 10<sup>-1</sup> ... .3

**CHAPTER 4**  
**SOURCE EXAMPLES**

```

DS2 S      3      ... 3      4      ... 4
SI3      0      .2      ... 1
SP3 D      0      10-4 ... .1
SI4      0      .1      ... 1
SP4 D      0      10-2 ... .1
SI5      37
SP5      -21    1

```

\$ Level 2

\$ Optional card

This example of the general source illustrates two levels of dependency. Let us assume a duct streaming problem where the source at the duct opening has been obtained from a reactor calculation. Energies above 13.5 MeV have one angular distribution and energies below 13.5 MeV have a different angular distribution. The source has a uniform spatial distribution on a circular disk of radius 37 cm centered at  $x,y,z$  on planar surface 1 going into cell 2.

This example can be expanded by having the source in two ducts instead of one (with the same energy and angular distribution as before). The SI1, SP1, DS2, SI3, SP3, SI4, and SP4 cards remain unchanged. The SDEF card is changed as shown below and the other cards are added.

```

SDEF      ERG = D1  DIR FERG D2  SUR = D6  CEL FSUR D7
          POS FSUR D8  RAD FSUR D9  VEC FSUR D10
SI6      L      1      7
SP6      D      .6      .4
DS7      L      2      8
DS8      L      x1 y1 z1  x2 y2 z2
DS9      S      11     12
DS10     L      u1 v1 w1  u2 v2 w2
SI11     0      37
SP11     -21    1
SI12     0      25
SP12     -21    1

```

Example 2: This example is a two-source-cell problem where the material in one cell is uranium and in the other is thorium. The uranium cell has two isotopes, <sup>235</sup>U and <sup>238</sup>U, and the thorium has one, <sup>232</sup>Th. Each isotope has many photon lines from radioactive decay. The following input cards describe this source.

```

SDEF      CEL = D1  ERG FCEL D2  ...
SC1      source cells
SI1      L      1      2
SP1      D      2      1
SC2      source "spectra"
DS2      S      3      4
SC3      uranium nuclides

```

\$ Level 1

\$ Level 2

SI3	S	5	6	
SP3	D	1	3	
SC4	thorium nuclide			
SI4	S	7		
SP4	D	1		
SC5	U235 photon lines			\$ Level 3
SI5	L	$E_I$	...	$E_I$
SP5	D	$I_I$	...	$I_I$
SC6	U238 photon lines			
SI6	L	$E_I$	...	$E_J$
SP6	D	$I_I$	...	$I_J$
SC7	Th232 photon lines			
SI7	L	$E_I$	...	$E_K$
SP7	D	$I_I$	...	$I_K$

Example 3:

SDEF	SUR = D1	CEL	FSUR D2	ERG	FSUR D6
	X FSUR D3	Y FSUR D4	Z FSUR D5		
SI1	L	10	0		
SP1		.8	.2		
DS2	L	0	88		
DS6	S	61	62		
SP61		-3	.98	2.2	
SP62		-3	1.05	2.7	
DS3	S	0	31		
SI31		20	30		
SP31		0	1		
DS4	S	0	41		
SI41		-17	36		
SP41		0	1		
DS5	S	0	51		
SI51		-10	10		
SP51		0	1		

Of the particles from this source, 80% start on surface 10, and the rest start in cell 88. When a particle starts in cell 88, its position is sampled, with rejection, in the rectangular polyhedron bounded by  $x = 20$  to  $30$ ,  $y = -17$  to  $36$ , and  $z = -10$  to  $10$ . When a particle starts on surface 10, its cell is found from its position and direction. The energy spectrum of the particles from surface 10 is different from the energy spectrum of the particles from cell 88. A zero after the S option invokes the default variable value.

Example 4:

SDEF	ERG=D1	DIR	FERG D2	SUR=m
SI1	$E_I$	$E_2$	...	$E_k$
SP1	0	$P_2$	...	$P_k$



**CHAPTER 4**  
**SOURCE SUBROUTINE**

```

DS2      Q .3 21 .8 22 1.7 23 20. 24
SP21     -21  1
SP22     -21  1.1
SP23     -21  1.3
SP24     -21  1.8

```

This is an example of using the Q option. The low-energy particles from surface *m* come out with a cosine distribution of direction, but the higher-energy particles have a more nearly radial distribution. The energy values on the DS2 card need not be the same as any of the  $E_i$  on the SI1 card.

**VI. SOURCE SUBROUTINE**

When possible, you should take advantage of the standard sources provided by the code rather than write a source subroutine. When you write your own source subroutine, you lose features such as sampling from multiple distributions, using dependent distributions, and having frequency prints for each tabular distribution. Also, subroutine SRCDX is needed.

The standard sources, however, cannot handle all problems. If the general source (SDEF card), surface source (SSR), or criticality source (KCODE card) is unsuitable for a particular application, MCNP provides a mechanism to furnish your own source-modeling capability. The absence of SDEF, SSR, or KCODE cards causes MCNP to call subroutine SOURCE, which you must supply. Subroutine SOURCE specifies the coordinates, direction, weight, energy, and time of source particles as listed and defined on page 3–40. If the value of IPT (particle type) set by STARTP, which calls SOURCE, is not satisfactory, SOURCE must also specify IPT. STARTP sets IPT=1 (neutron) for MODE N, N P, and N P E; sets IPT=2 (photon) for MODE P and P E; and sets IPT=3 (electron) for MODE E. MCNP checks the user's source for consistency of cell, surface, direction, and position. If the source direction is anisotropic and there are point detectors or DXTRAN spheres, an SRCDX subroutine is also required (see page 4–52). The SOURCE subroutine can be put into MCNP with PRPR.

The following example of a subroutine SOURCE uses SIn, SPn, and SBn cards and demonstrates the use of MCNP subroutines SMPSRC, ROTAS, CHKCEL, and the function NAMCHG. The geometry is a 5-cm-long cylinder centered about the y-axis, divided into 5 cells by PY planes at 1-cm intervals. The 1-MeV monoenergetic source is a biased isotropic distribution that is also biased along the y-axis. The input distribution cards are

```

SI1      -1  0  1          $ These 3 cards
SP1      0  1  1          $ represent a biased
SB1      0  1  2          $ isotropic distribution.
SI2      0  1  2  3  4  5  $ These 3 cards
SP2      0  4  2  2  1  1  $ represent a biased

```

```
SB2  0  1  1  2  2  4  $ distribution in y.
RDUM 1                                $ cylindrical radius
IDUM 2  4  6  8  10  $ source cells
```

This problem can be run with the general source by removing the RDUM and IDUM cards and adding:

```
SDEF  ERG=1  VEC=0 1 0  AXS=0 1 0  DIR=D1  EXT=D2  RAD=D3
SI3   0 1  $ represents a covering surface of radius 1
SP3  -21 1  $ samples from the power law with k=1
```

```
*IDENT SRCEX
*D,SO.11
      DIMENSION A(3)
      WGT=1.
C  RDUM(1)--RADIUS OF SOURCE CYLINDER.
C  SAMPLE RADIUS UNIFORM IN AREA.
      R=RDUM(1)*SQRT(RANG())
C  Y COORDINATE POSITION, PROBABILITY AND BIAS ARE
C  DEFINED IN DISTRIBUTION 2 BY THE SI2, SP2, SB2 CARDS.
C  SAMPLE FOR Y.
C  IB RETURNS THE INDEX SAMPLED AND FI THE INTERPOLATED FRACTION.
C  NEITHER ARE USED IN THIS EXAMPLE.
      CALL SMPSRC(YYY,2,IX]B,FI)
C  SAMPLE FOR X AND Z.
      TH=2.*PIE*RANG()
      XXX=-R*SIN(TH)
      ZZZ=R*COS(TH)
C  DIRECTION IS ISOTROPIC BUT BIASED IN CONE ALONG Y-AXIS
C  DEFINED AS DISTRIBUTION 1 BY THE SI1, SP1, SB1 CARDS.
C  SAMPLE FOR CONE OPENING C=COS(NU).
C  ROTAS SAMPLES A DIRECTION U,V,W at AN ANGLE ARCCOS(C)
C  FROM THE REFERENCE VECTOR UOLD(3)
C  AND AT AN AZIMUTHAL ANGLE SAMPLED UNIFORMLY.
      CALL SMPSRC(C,1,IB,FI)
      UOLD(1)=0.
      UOLD(2)=1.
      UOLD(3)=0.
      CALL ROTAS(C,UOLD,A,LEV,IRT)
      UUU=A(1)
      VVV=A(2)
      WWW=A(3)
C  CELL SOURCE - FIND STARTING CELL.
```

## CHAPTER 4

### SRCDX SUBROUTINE

```
C  IDUM(1)-IDUM(5)--LIST OF SOURCE CELLS (PROGRAM NAME) .
      JSU=0
      DO 10 I=1,5
      ICL=NAMCHG(1, IDUM(I))
      CALL CHKCEL(ICL, 2, J)
      IF(J.EQ.0) GO TO 20
10  CONTINUE
      CALL EXPIRE(1, 'SOURCE' ,
1   'SOURCE IS NOT IN ANY CELLS ON THE IDUM CARD.')
20  ERG=1.
      TME=0.
```

### VII. SRCDX SUBROUTINE

If a user has supplied a subroutine SOURCE that does not emit particles isotropically (uniform emission in all directions) and is using either a detector tally or DXTRAN in the calculations, then subroutine SRCDX must also be supplied to MCNP. The structure of this subroutine is the same as for subroutine SOURCE, except that usually only a single parameter, *PSC*, needs to be specified for each detector or set of DXTRAN spheres. *PSC* as defined in SRCDX is used to calculate the direct contribution from the source to a point detector, to the point selected for the ring detector, or DXTRAN sphere. Other parameters may also be specified in SRCDX. For example, if a quantity such as particle energy and/or weight is directionally dependent, its value must be specified in both subroutine SOURCE and SRCDX. When using detectors and a subroutine SOURCE with an anisotropic distribution, check the direct source contribution to the detectors carefully to see if it is close to the expected result.

In general, it is best to have as few directionally-dependent parameters as possible in subroutine SOURCE. Directionally dependent parameters must also be dealt with in subroutine SRCDX.

The most general function for emitting a particle from the source in the laboratory system can be expressed as  $p(\mu, \phi)$ , where  $\mu$  is the cosine of the polar angle and  $\phi$  is the azimuthal angle in the coordinate system of the problem. Most anisotropic sources are azimuthally symmetric and  $p(\mu, \phi) = p(\mu)/2\pi$ . The quantity  $p(\mu)$  is the probability density function for the  $\mu$  variable only (that is,  $\int p(\mu) d\mu = 1$ ,  $p(\mu) \geq 0$ ). *PSC* is  $p(\mu_o)$ , where  $\mu_o$  is the cosine of the angle between the direction defining the polar angle for the source and the direction to a detector or DXTRAN sphere point in the laboratory system. (MCNP includes the  $2\pi$  in the calculation automatically.) Note that  $p(\mu_o)$  and hence *PSC* may have a value greater than unity and must be non-negative. It is valuable to point out that every source must have a cumulative distribution function based on  $p(\mu, \phi)$  from which to sample angular dependence. The probability density function  $p(\mu, \phi)$  needs only to be considered explicitly for those problems with detectors or DXTRAN.

Table 4.1 gives the equations for  $PSC$  for six continuous source probability density functions. More discussion of probability density functions is given in the detector theory section of Chapter 2 (see page 2–75). The isotropic case is assumed in MCNP; therefore SRCDX is required only for the anisotropic case.

**TABLE 4.1:**  
**Continuous Source Distributions and their Associated PSC's**

	<u>Source Description</u>	<u>Source Distribution</u>	<u>PSC</u>	<u>Range of <math>\mu_o</math></u>
1.	Isotropic	Uniform	0.5	$-1 \leq \mu_o \leq 1$
2.	Surface Cosine	$\mu$	$2 \mu_o $	$0 \leq \mu_o \leq 1$ (or $-1 \leq \mu_o \leq 0$ )
			0	$-1 \leq \mu_o < 0$ (or $0 < \mu_o \leq 1$ )
3.	Point Cosine	$ \mu $	$ \mu_o $	$-1 \leq \mu_o \leq 1$
4.	Point Cosine*	$a + b\mu$	$\frac{2(a + b\mu_o)}{2a + b}$	$0 \leq \mu_o \leq 1$
			$\left(\frac{2(a + b\mu_o)}{2a - b}\right)$	$(-1 \leq \mu_o \leq 0)$
			0	$-1 \leq \mu_o < 0$ (or $0 < \mu_o \leq 1$ )
5.	Point Cosine*	$a + b\mu, a \neq 0$	$\frac{a + b\mu_o}{2a}$	$-1 \leq \mu_o \leq 1$
6.	Point Cosine*	$a + b \mu $	$\frac{a + b \mu_o }{2a + b}$	$-1 \leq \mu_o \leq 1$

\*The quantities  $a$  and  $b$  must have values such that  $PSC$  is always nonnegative and finite over the range of  $\mu_o$ .

As an example of calculating  $\mu_o$ , consider a spherical surface cosine source (type 2 in Table 4.1) with several point detectors in the problem. Assume that a point on the spherical surface has been selected at which to start a particle. The value of  $\mu_o$  for a detector is given by the scalar (or dot) product of the two directions; that is,

**CHAPTER 4**  
**SRCDX SUBROUTINE**

$$\mu_o = uu' + vv' + ww' \quad , \quad (4.1)$$

where  $u$ ,  $v$ , and  $w$  are the direction cosines of the line from the source point to the point detector location and  $u'$ ,  $v'$ , and  $w'$  are the direction cosines for either the outward normal if the surface source is outward or the inward normal if the source is inward.

If  $u = u'$ ,  $v = v'$ , and  $w = w'$ , then  $\mu_o = 1$ , indicating that the point detector lies on the normal line. The value of  $PSC$  for the detector point is

$$\begin{aligned} PSC &= 2|\mu_o|, \quad \mu_o > 0 \quad (\mu_o < 0) \\ &= 0, \quad \mu_o \leq 0 \quad (\mu_o \geq 0) \quad , \end{aligned}$$

where the parenthetical values of  $\mu_o$  are for the inward-directed cosine distribution.

For  $|\mu_o|$  less than 0.25 in case 2 of Table 4.1,  $PSC$  is less than 0.5, which is the value for an isotropic source. This means that source emissions for these values of  $|\mu_o|$  are less probable than the isotropic case for this source distribution. The converse is also true. Note that if  $|\mu_o|$  is greater than 0.5,  $PSC$  is greater than one, which is perfectly valid.

An example of a subroutine SRCDX with appropriate PRPR lines for a surface outward cosine distribution is shown in Figure 4.21. This is basically the technique that is used in MCNP to calculate  $PSC$  for a spherical surface source in a cosine distribution; the only difference is that MCNP uses the cosines of the direction from the center of the sphere used to select the source point because this is the normal to the spherical surface. The primed direction cosines were calculated in Figure 4.21 to aid in illustrating this example. The direction cosines  $u$ ,  $v$ , and  $w$  as defined in Equation (4.1) have already been calculated in subroutine DDDDET when SRCDX is called and are available through COMMON.

```
*I , SX . 5
C  CALCULATE PSC FOR A SURFACE (SPHERE) OUTWARD COSINE DIST
C  FIND THE DIRECTION COSINES FOR THIS EXAMPLE BASED
C  ON THE SOURCE POINT ON THE SPHERE (X , Y , Z) .
      UP = (XXX - RDUM(1)) / RDUM(4)
      VP = (YYY - RDUM(2)) / RDUM(4)
      WP = (ZZZ - RDUM(3)) / RDUM(4)
C  (RDUM(1) , RDUM(2) , RDUM(3)) ARE THE COORDINATES OF THE CENTER
C  OF THE SPHERE FROM THE RDUM CARD. RDUM(4) IS THE RADIUS .
C  U , V , AND W HAVE BEEN CALCULATED FOR THE CURRENT
C  POINT DETECTOR IN SUBROUTINE DDDDET
      PSC = 2 . * MAX ( ZERO , UUU * UP + VVV * VP + WWW * WP )
```

**Figure 4-21.**

The PRPR cards in Figures 4.21 and 4.22 are the recommended procedure for replacing the existing dummy SRCDX subroutine.

For many sources, a discrete probability density function will be used. In this situation, a cumulative distribution function  $P(\mu)$  is available and is defined as

$$P(\mu) = \int_{-1}^{\mu} p(\mu') d\mu' \text{ and } P_{i+1} = \sum_{j=1, i} p_j \Delta\mu_j ,$$

where  $p_j$  is an average value of the probability density function in the interval  $\Delta\mu_j$ . Thus, the probability density function is a constant  $p_j$  in the interval  $\Delta\mu_j$ . For this case, there are  $N$  values of  $P_i$  with  $P_1 = 0$ ,  $P_{N+1} = 1.0$  and  $P_{i-1} < P_i$ . Each value of  $P_i$  has an associated value of  $\mu_i$ . Because  $PSC$  is the derivative of  $P(\mu_o)$ , then

$$PSC = \frac{P_i - P_{i-1}}{\mu_i - \mu_{i-1}}, \mu_{i-1} \leq \mu_o < \mu_i \quad . \quad (4.2)$$

This is an average  $PSC$  between  $\mu_{i-1}$  and  $\mu_i$  and is also an average value of  $p(\mu)$  in the specified range of  $\mu$ .

Frequently, the cumulative distribution function is divided into  $N$  equally probable intervals. For this case,

$$PSC = \frac{1}{N} \frac{1}{\mu_i - \mu_{i-1}} \quad .$$

This is precisely the form used in MCNP for calculating contributions to the point detector for elastic scattering with  $N = 32$ .

An example of a subroutine SRCDX for a discrete probability density function is shown in Figure 4.22. This subroutine would work with the subroutine SOURCE example on page 4-51, and would calculate  $PSC = 1/2$  for the isotropic distribution.

A biased anisotropic distribution can also be represented by

SIn	$\mu_o$	$\mu_1 \dots \mu_n$
SPn	0	$p_1 \dots p_n$
SBn	0	$q_1 \dots q_n$

A reference vector  $u', v', w'$  for this distribution is also needed.

## CHAPTER 4

### SRCDX SUBROUTINE

The subroutine SOURCE input cards can be modified for this case by changing the SII, SP1, SB1, and RDUM cards as follows:

SII	-1	0	1		\$ These 3 cards
SP1	0	2	1		\$ represent a biased
SB1	0	1	2		\$ anisotropic distribution.
RDUM	1	0	1	0	\$ cylindrical radius and reference vector

SOURCE would sample this anisotropic distribution and SRCDX would calculate the appropriate *PSC*.

```
*I, SX. 5
C THE VARIABLY DIMENSIONED BLOCK SPF HOLDS THE SI, SP, SB ARRAYS.
C THE KSD ARRAY IS A POINTER BLOCK TO THE SPF ARRAY.
C THE FOLLOWING STATEMENT FUNCTION IS DEFINED.
      K(I,J)=KSD(LKSD+I,J)
C RDUM(2),RDUM(3),RDUM(4)--DIRECTION COSINES
C FOR THE SOURCE REFERENCE DIRECTION.
      AM=UUU*RDUM(2)+VVV*RDUM(3)+WWW*RDUM(4)
C K(4,1) IS THE LENGTH OF THE DISTRIBUTION.
C K(13,1) IS THE OFFSET INTO THE SPF BLOCK.
      DO 10 I=1,K(4,1)-1
10  IF(SPF(K(13,1)+1,I).LE.AM.AND.SPF(K(13,1)+1,I+1).GE.AM)
      1 GO TO 20
      GO TO 30
20  PSC=(SPF(K(13,1)+2,I+1)-SPF(K(13,1)+2,I))/
      1 (SPF(K(13,1)+1,I+1)-SPF(K(13,1)+1,I))
      PSC=PSC*SPF(K(13,1)+3,I+1)
      RETURN
30  PSC=0.
```

**Figure 4-22.**

It is extremely important to note that the above case applies only when the source is anisotropic with azimuthal symmetry. For the general case,

$$PSC = 2\pi p(\mu_o, \varphi_o) .$$

The  $2\pi$  factor must be applied by the user because MCNP assumes azimuthal symmetry and, in effect, divides the user-defined *PSC* by  $2\pi$ .

For a continuous  $p(\mu, \varphi)$  function, *PSC* is calculated as above. In the case of a discrete probability density function,

$$PSC = 2\pi \cdot \overline{p(\mu_o, \phi_o)} = \frac{2\pi(P_i - P_{i-1})}{(\mu_i - \mu_{i-1})(\phi_i - \phi_{i-1})}$$

$$= \frac{2\pi(P_i - P_{i-1})}{\Delta\mu_i \Delta\phi_i}$$

where  $\mu_{i-1} \leq \mu_o < \mu_i$ ,  $\phi_{i-1} \leq \phi_o < \phi_i$  and  $\overline{p(\mu_o, \phi_o)}$  is an average probability density function in the specified values of  $\mu_o$  and  $\phi_o$  and  $P_i - P_{i-1}$  is the probability of selecting  $\mu_o$  and  $\phi_o$  in these intervals. For  $N$  equally probable bins and  $n$  equally spaced  $\Delta\phi$ 's, each  $2\pi/n$  wide,

$$PSC = \frac{n}{N} \frac{1}{\Delta\mu_i} .$$

Another way to view this general case is by considering solid angles on the unit sphere. For an isotropic source, the probability ( $P_i - P_{i-1}$ ) of being emitted into a specified solid angle is the ratio of the total solid angle ( $4\pi$ ) to the specified solid angle ( $\Delta\phi\Delta\mu$ ). Then,  $PSC \equiv 0.5$ . Thus, for the general case (normed to  $PSC \equiv 0.5$  for an isotropic source)

$$PSC = \frac{(0.5)(P_i - P_{i-1})4\pi}{\Delta\mu\Delta\phi_i} = \frac{2\pi(P_i - P_{i-1})}{\Delta\mu_i\Delta\phi_i} .$$

Note that  $PSC$  is greater than 0.5 if the specified solid angle  $\Delta\mu\Delta\phi_i$  is less than  $(P_i - P_{i-1})4\pi$ . This is the same as the previous general expression.

**CAUTIONS:**

You are cautioned to be extremely careful when using your own subroutine SOURCE with either detectors or DXTRAN. This caution applies to the calculation of the direct contribution from the source to a point detector, point on a ring, or point on a DXTRAN sphere. Not only is there the calculation of the correct value of PSC for an anisotropic source, but there may also be problems with a biased source.

For example, if an isotropic source is biased to start only in a cone of a specified angle (for example,  $\psi$ ), the starting weight of each particle should be  $WGT*(1 - \cos \psi)/2$ , where  $WGT$  is the weight of the unbiased source (that is,  $WGT$  is the expected weight from a total source). The weight in SRCDX must be changed to the expected weight  $WGT$  to calculate the direct contribution to a point detector correctly if  $PSC$  is defined to be 0.5.

This example can be viewed in a different way. The probability density function for the above biased source is



## CHAPTER 4

### SRCDX SUBROUTINE

$$p(\mu) = \frac{1}{1 - \cos\Psi} , \text{ for } \cos\Psi \leq \mu \leq 1$$
$$= 0 \quad \text{for } -1 \leq \mu < \cos\Psi .$$

Thus, *PSC* is this constant everywhere in the cone and zero elsewhere. Multiplying this *PSC* and biased starting weight gives

$$WGT * (1 - \cos \psi) * 0.5 / (1 - \cos \psi)$$

or  $WGT * 0.5$ , which is the expected result for an isotropic source.

Another source type that requires caution is for a user supplied source that is energy-angle correlated. For example, assume a source has a Gaussian distribution in energy where the mean of the Gaussian is correlated in some manner with  $\mu$ . In subroutine *SRCDX*, the  $\mu_o$  to a point detector must be calculated and the energy of the starting particle must be sampled from the Gaussian based on this  $\mu_o$ . This must be done for each point detector in the problem, thus guaranteeing that the direct source contribution to each detector will be from the proper energy spectrum. The original energy of the starting particle, as well as all of the other starting parameters, selected in subroutine *SOURCE* are automatically restored after the direct source contribution to detectors is made. Thus, the subroutine *SOURCE* is still sampled correctly.

## CHAPTER 5

### OUTPUT

#### WHAT IS COVERED IN CHAPTER 5

This chapter shows annotated output from four test problems and an event log print:

DEMO	illustrates tally flexibility
TEST1	annotated tables produced by PRINT card
CONC	output associated with detectors and detector diagnostics
KCODE	output from a criticality calculation (GODIVA)
Event log	event log and debug prints

Portions of the complete output have been excluded. The line “SKIP nnn LINES IN OUTPUT” indicates these omissions.

The event log and debug prints help find errors if you set up a geometry improperly or modify the code. The DBCN input card also is useful when finding errors but is not discussed here.

MCNP prints out warning messages if needed. Do not ignore these warning messages. Look up the pertinent section in the manual if you need explanation to help you understand what you are being warned about.

#### ***I. DEMO PROBLEM AND OUTPUT***

DEMO has a point isotropic neutron source (SDEF) in the center of a tungsten cube (M2), with energy uniformly distributed from 0.1 to 10 MeV (SI1,SP1). Flux is calculated across each facet of the cube (F2), across the sum of all facets (F22), and across the sum of some of the facets (F12). A pulse height tally (F8) is made in the tungsten cell. Selected pages of the output file follow.

The FQ card in the DEMO input file changes the printing order. Depending upon what you are interested, the tally output can be made more readable. FQ2 causes energy to be printed as a function of surface. FQ22 causes surface to be printed as a function of energy. FQ62 prints multiplier bins as a function of energy for the two surfaces desired. The NT and T features also are illustrated in tallies 62 and 22, respectively. The generalized FM62 card used with the F62:N tally is a useful feature for normalization, unit conversion, reaction rate, etc., and has three multipliers instead of one. Finally, the TF62 card causes the tally fluctuation chart for the second surface, the first multiplier bin, and the second energy bin to be printed. By default the fluctuation chart for tally 62 would contain information for the first surface, the first multiplier bin, and the last energy bin.

## CHAPTER 5

### DEMO PROBLEM AND OUTPUT

The F8:E card provides a pulse height tally in cell 1. The F8 tally capability is limited to an analog problem. The default implicit capture is turned off by the CUT:N card. Analog capture is the default for photons and electrons, so CUT:P and CUT:E cards are not required. The pulse height tally tracks the energy deposited in a cell by both photons and electrons, even if only E or P is on the F8 card. The F8 tally is not available for neutrons and will return an error if attempted. In the following output is a warning that “f8 tally unreliable since neutron transport nonanalog”. This message means some nonanalog events such as (n,2n) may have occurred to the neutron from the source to the production of a photon, not that there is an F8:N tally or that there is some neutron variance reduction in the definition of the problem.

A tally fluctuation chart bin analysis follows each tally. Only an analysis for tally 8 is shown in this example. This analysis checks the variance of the variance as well as the general behavior of the probability density function of each tally and provides an additional set of checks to ensure the reliability of a tally. Ten different statistical checks are run for the tally and presented in tabular form. The results of the ten checks are presented in pass?yes/no table format. These checks do not guarantee the absolute reliability of the tally, but they provide a better method of identifying problems that have not been sampled well. A more complete description of the significance of each entry in the tally fluctuation section is presented in TEST1.

There are three possible physics treatments for problems involving photons. The first is the explicit p,e treatment where photons generate electrons that are tracked and generate photons (ad infinum). This is the most accurate model but is costly in terms of runtime. The second physics treatment is mode p only that uses the default ‘thick target bremsstrahlung’ (TTB) model where electrons are generated in the direction of the incident photon and are immediately annihilated after generating bremsstrahlung photons. The third photon physics treatment is a mode p only with the thick target bremsstrahlung turned off (IDES=1 on the PHYS card). Then electrons are completely ignored.

The choice of which physics treatment to use depends on the objective of the problem being solved. Using a test problem similar to the cube above it was found that F4 photon tallies for the three treatments agreed reasonably well above 2 MeV. Below 1 MeV the results from the simplest model (photon mode no bremsstrahlung) began to diverge from the full physics model results. Below the annihilation photon peak, the TTB treatment also begins to diverge from the mode p,e results. The choice of physics treatment had a drastic impact on the runtime of the problem. To run 1E6 particles on a SGI 2000 mode p with and without thick target bremsstrahlung took 2.25 and 1.70 minutes respectively, while the full physics mode p,e problem took just over 17 hours. If it is necessary to model photon generation and transport below 0.5 MeV then the full physics model should be used. However if these low energy photons are not important or if the calculation is for diagnostic purposes, then the mode p with or without thick target bremsstrahlung model is sufficient.

The small table preceding the summary of statistical checks indicates that some of the tally scores were not made for some reason. In the case of tally 2, 93547 particles did not score in any of the bins because their energy was greater than that of the upper limit of the highest energy bin. Tallies 12, 22, and 62 also had significant numbers of particles that had energies above the highest energy bin. This is concerning since for tally 2 the number of particles not scored is nearly 90% of the initial source particles. This can be fixed by simple increasing the upper limit of the last energy bin, or adding more bins to cover the energy range up to the maximum energy of the source (10 MeV).

CHAPTER 5  
 DEMO PROBLEM AND OUTPUT

```

lmcnp      version 4c      lq=01/20/00      07/19/00 14:32:23
*****
i=demo name=demo.
          probid = 07/19/00 14:32:23

1-      demo: a box with flux across surfaces in various combinations
2-      1 2 -1.6 -1
3-      2 0 1
4-
5-      1 rpp -1 1 -1 1 -1 1
6-
7-      cut:n 10000 0.0 0.0 0.0
8-      mode n p e
9-      sdef pos=0 0 0 cel=1 wgt=1 erg=dl
10-     sil 0.1 10
11-     sp1 0 1
12-     imp:n,p,e 1 0
13-     e0 0.2 0.4 0.6 0.8 1
14-     f2:n 1.1 1.2 1.3 1.4 1.5 1.6
15-     fq2 e f
16-     f12:n (1.3 1.5) (1.4 1.6) (1.2 1.1)
17-     f22:n 1.1 1.2 1.3 1.4 1.5 1.6 t
18-     fq22 f e
19-     m1 6000.50c 1
warning. material 1 is used only for a perturbation or tally.
20-     m2 74000.55c 1
21-     f62:n 1.3 1.4
22-     fm62 (1.2(1 -4)(-2))(1 1 1)
23-     e62 0.2 0.4 0.6 0.8 1 nt $
24-     fq62 m e
25-     tf62 2 5j 2
26-     f8:e 1

warning. f8 tally unreliable since neutron transport nonanalog.
27-     e8 0.001 10i 20 $
28-     nps 104000

warning. tally 8 needs zero energy bin for negative f8 scores.
SKIP 482 LINES IN OUTPUT
ltally 22      nps = 104000
          tally type 2      particle flux averaged over a surface.      units 1/cm**2
  
```

tally for neutrons

areas

surface:	1.1	1.2	1.3	1.4	1.5	1.6	total
4.00000E+00	4.00000E+00	4.00000E+00	4.00000E+00	4.00000E+00	4.00000E+00	4.00000E+00	2.40000E+01

energy:

surface	2.0000E-01	4.0000E-01	6.0000E-01	8.0000E-01	1.0000E+00					
1.1	7.30357E-04	0.0942	1.29205E-03	0.0513	1.18025E-03	0.0653	1.17268E-03	0.0651	1.16323E-03	0.0534
1.2	6.57953E-04	0.0686	1.15327E-03	0.0508	1.05268E-03	0.0545	1.13600E-03	0.0519	1.18122E-03	0.0643
1.3	6.33307E-04	0.0756	1.27882E-03	0.0717	1.13639E-03	0.0528	1.17168E-03	0.0521	1.13825E-03	0.0524
1.4	6.52386E-04	0.0705	1.07859E-03	0.0576	1.21496E-03	0.0528	1.25657E-03	0.0495	1.05426E-03	0.0537
1.5	6.11844E-04	0.0711	1.21984E-03	0.0522	1.25661E-03	0.0487	1.26987E-03	0.0496	1.15210E-03	0.0516
1.6	6.60230E-04	0.0686	1.15995E-03	0.0522	1.19812E-03	0.0515	1.10335E-03	0.0526	1.07351E-03	0.0543
total	6.57680E-04	0.0312	1.19709E-03	0.0231	1.17317E-03	0.0221	1.18503E-03	0.0217	1.12710E-03	0.0224

energy: total

surface	total
1.1	5.53857E-03
1.2	5.18112E-03
1.3	5.35846E-03
1.4	5.25677E-03
1.5	5.51027E-03
1.6	5.19516E-03
total	5.34006E-03

SKIP 227 LINES OF OUTPUT

ltally 8 nps = 104000

tally type 8 pulse height distribution. units number

tally for photons electrons

cell 1

energy	units
1.0000E-03	1.88365E-02
1.8191E+00	1.50962E-02
3.6372E+00	2.59615E-04
5.4553E+00	7.69231E-05
7.2734E+00	4.80769E-05
9.0915E+00	1.92308E-05
1.0910E+01	0.00000E+00
1.2728E+01	0.00000E+00
1.4546E+01	0.00000E+00
1.6364E+01	0.00000E+00
1.8182E+01	0.00000E+00
2.0000E+01	0.00000E+00
total	3.43365E-02

lanalysis of the results in the tally fluctuation chart bin (tfc) for tally 8 with nps = 104000 print table 160

normed average tally per history = 3.43365E-02 unnormed average tally per history = 3.43365E-02

# CHAPTER 5 DEMO PROBLEM AND OUTPUT

```

estimated tally relative error = 0.0164          estimated variance of the variance = 0.0003
relative error from zero tallies = 0.0164      relative error from nonzero scores = 0.0000

number of nonzero history tallies = 3571      efficiency for the nonzero tallies = 0.0343
history number of largest tally = 13          largest unnormalized history tally = 1.00000E+00
(largest tally)/(average tally) = 2.91235E+01 (largest tally)/(avg nonzero tally)= 1.00000E+00

(confidence interval shift)/mean = 0.0001     shifted confidence interval center = 3.43410E-02

```

if the largest history score sampled so far were to occur on the next history, the tfc bin quantities would change as follows:

```

estimated quantities          value at nps          value at nps+1      value(nps+1)/value(nps)-1.
mean                          3.43365E-02        3.43458E-02        0.000270
relative error                 1.64444E-02        1.64420E-02       -0.000145
variance of the variance      2.51529E-04        2.51451E-04       -0.000310
shifted center                 3.43410E-02        3.43410E-02        0.000000
figure of merit                1.28091E+03        1.28128E+03        0.000290

```

the 100 largest history tallies appear to have a maximum value of about 1.00000E+00  
the large score tail of the empirical history score probability density function appears to have no unsampled regions.

```

=====
results of 10 statistical checks for the estimated answer for the tally fluctuation chart (tfc) bin of tally 8

tfc bin  --mean--  -----relative error-----  ----variance of the variance----  --figure of merit--  -pdf-
behavior  value  decrease  rate  value  decrease  rate  value  decrease  rate  value  behavior  slope
desired  random  <0.10  yes  1/sqrt(nps)  <0.10  yes  1/nps  constant  random  >3.00
observed  random  0.02  yes  yes  0.00  yes  yes  constant  random  10.00
passed?   yes  yes  yes  yes  yes  yes  yes  yes  yes  yes  yes

=====

```

this tally meets the statistical criteria used to form confidence intervals: check the tally fluctuation chart to verify.  
the results in other bins associated with this tally may not meet these statistical criteria.

```

estimated asymmetric confidence interval(1,2,3 sigma): 3.3776E-02 to 3.4906E-02; 3.3212E-02 to 3.5470E-02; 3.2647E-02 to 3.6035E-02
estimated symmetric confidence interval(1,2,3 sigma): 3.3772E-02 to 3.4901E-02; 3.3207E-02 to 3.5466E-02; 3.2643E-02 to 3.6030E-02

```

```

fom = (histories/minute)*(f(x) signal-to-noise ratio)**2 = (3.602E+04)*( 1.886E-01)**2 = (3.602E+04)*(3.556E-02) = 1.281E+03
1  some tally scores were not made for various reasons:

```

```

tally      beyond last bin      not in
           angle  energy  time  user
    2      0  93547      0      0
   12      0  93547      0      0
   22      0  93547      0      0
   62      0  31134      0      0

```

1status of the statistical checks used to form confidence intervals for the mean for each tally bin

```

tally      result of statistical checks for the tfc bin (the first check not passed is listed) and error magnitude check for all bins
    2      missed 2 of 10 tfc bin checks: the figure of merit has a trend during the last half of the problem
           passed all bin error check: 36 tally bins all have relative errors less than 0.10 with no zero bins
   12      missed 3 of 10 tfc bin checks: the variance of the variance does not monotonically decrease over the last half of problem
           passed all bin error check: 18 tally bins all have relative errors less than 0.10 with no zero bins
   22      missed 2 of 10 tfc bin checks: the figure of merit has a trend during the last half of the problem
           passed all bin error check: 42 tally bins all have relative errors less than 0.10 with no zero bins
   62      missed 1 of 10 tfc bin checks: there is insufficient tfc bin tally information to estimate the large tally slope reliably
           passed all bin error check: 30 tally bins all have relative errors less than 0.10 with no zero bins
    8      passed the 10 statistical checks for the tally fluctuation chart bin result
           missed all bin error check: 13 tally bins had 6 bins with zeros and 4 bins with relative errors exceeding 0.10

```

the 10 statistical checks are only for the tally fluctuation chart bin and do not apply to other tally bins.

the tally bins with zeros may or may not be correct: compare the source, cutoffs, multipliers, et cetera with the tally bins.

warning. 4 of the 5 tally fluctuation chart bins did not pass all 10 statistical checks.

warning. 1 of the 5 tallies had bins with relative errors greater than recommended.

1tally fluctuation charts

nps	tally 2			tally 12			tally 22						
	mean	error	vov slope	mean	error	vov slope	mean	error	vov slope				
8000	4.6911E-03	0.0945	0.0153	5.6745E-03	0.0580	0.0033	0.0	1719	4.6911E-03	0.0945	0.0153	0.0	648
16000	4.8398E-03	0.0645	0.0059	5.6055E-03	0.0416	0.0020	3.2	1458	4.8398E-03	0.0645	0.0059	0.0	605
24000	5.2302E-03	0.0505	0.0035	5.5189E-03	0.0342	0.0013	3.5	1313	5.2302E-03	0.0505	0.0035	0.0	600
32000	5.2548E-03	0.0433	0.0025	5.5052E-03	0.0299	0.0013	2.2	1247	5.2548E-03	0.0433	0.0025	2.0	593
40000	5.3488E-03	0.0401	0.0074	5.3085E-03	0.0272	0.0011	2.4	1215	5.3488E-03	0.0401	0.0074	1.7	561
48000	5.3088E-03	0.0364	0.0056	5.3638E-03	0.0248	0.0009	2.3	1209	5.3088E-03	0.0364	0.0056	1.7	558
56000	5.5486E-03	0.0425	0.0630	5.3419E-03	0.0231	0.0009	2.1	1175	5.5486E-03	0.0425	0.0630	1.5	347
64000	5.6121E-03	0.0383	0.0534	5.3601E-03	0.0216	0.0008	2.0	1194	5.6121E-03	0.0383	0.0534	1.6	378
72000	5.5574E-03	0.0355	0.0468	5.3959E-03	0.0203	0.0007	2.0	1198	5.5574E-03	0.0355	0.0468	1.6	391
80000	5.5380E-03	0.0332	0.0408	5.3570E-03	0.0193	0.0006	2.1	1223	5.5380E-03	0.0332	0.0408	1.6	411
88000	5.5665E-03	0.0316	0.0340	5.3594E-03	0.0192	0.0064	1.9	1127	5.5665E-03	0.0316	0.0340	1.6	415
96000	5.5762E-03	0.0298	0.0302	5.3934E-03	0.0188	0.0091	1.9	1054	5.5762E-03	0.0298	0.0302	1.6	422



# CHAPTER 5 DEMO PROBLEM AND OUTPUT

431

1.7 5.5386E-03 0.0284 0.0274 1.9 1079

8 1.9 1079

1.7 431 5.4344E-03 0.0179 0.0078

431 1.7

1.7 431

1.7 431

1.7 431

1.7 431

1.7 431

1.7 431

1.7 431

1.7 431

nps	tally 62			tally 8			fom
	mean	error	vov slope	mean	error	vov slope	
8000	2.2306E-05	0.2087	0.0992	3.3500E-02	0.0601	0.0034	1604
16000	2.0345E-05	0.1462	0.0436	3.2250E-02	0.0433	0.0018	1344
24000	1.9682E-05	0.1195	0.0259	3.2708E-02	0.0351	0.0012	1243
32000	2.0456E-05	0.1000	0.0167	3.2594E-02	0.0305	0.0009	1201
40000	2.1405E-05	0.0960	0.0550	3.2850E-02	0.0271	0.0007	1225
48000	2.1120E-05	0.0866	0.0429	3.3104E-02	0.0247	0.0006	1217
56000	2.1137E-05	0.0793	0.0335	3.3304E-02	0.0228	0.0005	1208
64000	2.1388E-05	0.0732	0.0264	3.3734E-02	0.0212	0.0004	1239
72000	2.2092E-05	0.0691	0.0232	3.4250E-02	0.0198	0.0004	1259
80000	2.1131E-05	0.0666	0.0212	3.4000E-02	0.0188	0.0003	1278
88000	2.0994E-05	0.0634	0.0184	3.4284E-02	0.0179	0.0003	1292
96000	2.1022E-05	0.0602	0.0160	3.4656E-02	0.0170	0.0003	1286
104000	2.1130E-05	0.0574	0.0140	3.4337E-02	0.0164	0.0003	1281

\*\*\*\*\*  
dump no. 2 on file demo.r nps = 104000 coll = 9352864 ctm = 2.89 nrrn = 46800292  
\*\*\*\*\*

15 warning messages so far.

run terminated when 104000 particle histories were done.

computer time = 2.94 minutes

mcnp version 4c 01/20/00 07/19/00 14:35:44 probid = 07/19/00 14:32:23

**II. TEST1 PROBLEM AND OUTPUT**

TEST 1 defines a disk of concrete 100 cm thick, with a 75-cm radius. A 14.19 MeV neutron source is incident at a point in the center of a face of the disk and normal to it. Several neutron and photon tallies are made on surface 18 and in cell 17. There is no energy cutoff and the simple physics treatment that includes implicit capture is used for photons with energy greater than 0.001 MeV.

The disk is divided into 16 slabs, each 6.25 cm thick, as seen in Fig. 5.1. The neutron importance of each slab, or cell, varies from 0 in cell 1 to 32 in cell 17. Photon importances are set equal to neutron importances. The problem ran 10,000 particles and the tally means, errors, and *FOMS* shown in the tally fluctuation charts seem to be stable.

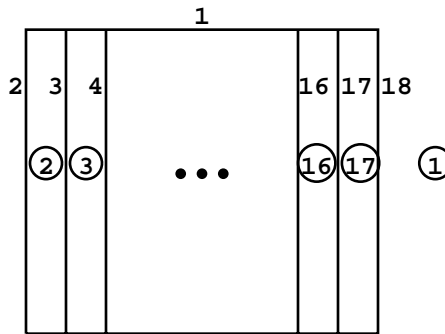

Figure 5.1

The weight window generator was used to generate a better importance function for subsequent runs. The resulting cards are printed at the end of the TEST1 output file and can be copied into an input file to be run a second time. Generation of weight windows did not affect the results of TEST1 but did slow down the calculation by 14%. When the importances in TEST1 were replaced by the generated weight windows (WWP and WWN cards), the problem took 14.27 minutes to run 10000 particles vs 10.01 minutes for TEST1. However, the photon *FOMS* increased by a factor of 2 to 3 and the errors decreased by half, while the means appeared to stay stable. The neutron means, errors, and *FOMS* stayed approximately the same, indicating that they were already well chosen to optimize tally 12. The use of the mesh-based weight window generator instead of the cell-based weight window generator for this problem did not significantly improve the FOM because the cell-based weight windows were quite good.

Following is a partial output from TEST1. The symbol **X** appearing left of the table title indicates that table does not appear unless the PRINT option or card is used. If **Nn**, where n is an integer, appears before an item on a page or below a column, that item is explained or discussed in Note **Nn** in the text following the output.

**CHAPTER 5  
TEST1 PROBLEM AND OUTPUT**

```

N1lmcnp      version 4c      ld=01/20/00      06/23/00 11:30:40
*****
N2i=test1 name=test1.      probid = 06/23/00 11:30:40
*****

N31-
2-
3-
4-
5-
6-
7-
8-
9-
10-
11-
12-
13-
14-
15-
16-
17-
18-
19-
20-
21-
22-
23-
24-
25-
26-
27-
28-
29-
30-
31-
32-
33-
34-
35-
36-
37-
38-
39-
40-
41-
42-

      test1: 100 cm thick concrete disk with 15 splitting surfaces
      c
      1      0      1 : -2 : 18
      2      1 -2.2505 -1 -3 2
      3      1 -2.2505 -1 -4 3
      4      1 -2.2505 -1 -5 4
      5      1 -2.2505 -1 -6 5
      6      1 -2.2505 -1 -7 6
      7      1 -2.2505 -1 -8 7
      8      1 -2.2505 -1 -9 8
      9      1 -2.2505 -1 -10 9
      10     1 -2.2505 -1 -11 10
      11     1 -2.2505 -1 -12 11
      12     1 -2.2505 -1 -13 12
      13     1 -2.2505 -1 -14 13
      14     1 -2.2505 -1 -15 14
      15     1 -2.2505 -1 -16 15
      16     1 -2.2505 -1 -17 16
      17     1 -2.2505 -1 -18 17
      18     1 -2.2505 -1 -18 17
      19     1 -2.2505 -1 -18 17
      20     1 -2.2505 -1 -18 17
      21     1 -2.2505 -1 -18 17
      22     1 -2.2505 -1 -18 17
      23     1 -2.2505 -1 -18 17
      24     1 -2.2505 -1 -18 17
      25     1 -2.2505 -1 -18 17
      26     1 -2.2505 -1 -18 17
      27     1 -2.2505 -1 -18 17
      28     1 -2.2505 -1 -18 17
      29     1 -2.2505 -1 -18 17
      30     1 -2.2505 -1 -18 17
      31     1 -2.2505 -1 -18 17
      32     1 -2.2505 -1 -18 17
      33     1 -2.2505 -1 -18 17
      34     1 -2.2505 -1 -18 17
      35     1 -2.2505 -1 -18 17
      36     1 -2.2505 -1 -18 17
      37     1 -2.2505 -1 -18 17
      38     1 -2.2505 -1 -18 17
      39     1 -2.2505 -1 -18 17
      40     1 -2.2505 -1 -18 17
      41     1 -2.2505 -1 -18 17
      42     1 -2.2505 -1 -18 17

      mode
      n p
      c the following is los alamos concrete
      ml 1001.60c 8.47636e-2
  
```

```

43-      8016.60c 6.04086e-1
44-     11023.60c 9.47250e-3
45-     12000.60c 2.99826e-3
46-     13027.60c 2.48344e-2
47-     14000.60c 2.41860e-1
48-     19000.60c 6.85513e-3
49-     20000.60c 2.04808e-2
50-     26054.60c 2.74322e-4
51-     26056.60c 4.26455e-3
52-     26057.60c 9.76401e-5
53-     26058.60c 1.30187e-5
N454-      sdef      pos=0 0 0 cel=2 wgt=1 vec=0 1 0 sur=2 dir=1 erg=14.19
55-      imp:n 0 1 5r 2 2 4 4 8 8 16 32
56-      imp:p 0 1 5r 2 2 4 4 8 8 16 32
N557-      pwt 0 -10 -9 -8 -7 -6 -5 -4 -3 -2 -1.7 -1.4 -1.0 -0.7 -0.4 -0.3 -0.2
58-      fl:p 18
59-      fl1:n 18
60-      fcl2 optimize weight window generator on tally 12
61-      fl2:p 18
62-      el2 20
63-      wwq 12 2
64-      f6:n,p 17
65-      e6 .00001 .0001 .001 .01 .05 .1 .5 1 13i 15 20
66-      fl6:n 17
67-      f26:p 17
68-      f34:n 17
69-      fm34 -1 1 1 -4
N670-      e0 .0001 .001 .01 .05 .1 .5 1 13i 15 20
71-      phys:n 15 0
72-      phys:p .001
73-      nps 10000
74-      print
X lsource

```

print table 10

N7 values of defaulted or explicitly defined source variables

```

cel      2.0000E+00
sur      2.0000E+00
erg      1.4190E+01
tme      0.0000E+00
dir      1.0000E+00
pos      0.0000E+00 0.0000E+00 0.0000E+00
x        0.0000E+00
y        0.0000E+00
z        0.0000E+00
rad      0.0000E+00
ext      0.0000E+00
axis     0.0000E+00 0.0000E+00 0.0000E+00

```

CHAPTER 5  
TEST1 PROBLEM AND OUTPUT

```
vec      0.0000E+00  1.0000E+00  0.0000E+00
ccc      0.0000E+00
nrm      1.0000E+00
ara      0.0000E+00
wgt      1.0000E+00
eff      1.0000E-02
par      0.0000E+00
```

order of sampling source variables.  
cel sur pos vec dir erg tme

**X** ltally 11

**N8** tally type 1 number of particles crossing a surface.  
tally for neutrons

print table 30

**N9**warning. energy bin limits adjusted for tally 11  
surfaces 18

**N10** energy bins

```
0.00000E+00 to 1.00000E-04 mev
1.00000E-04 to 1.00000E-03 mev
1.00000E-03 to 1.00000E-02 mev
1.00000E-02 to 5.00000E-02 mev
5.00000E-02 to 1.00000E-01 mev
1.00000E-01 to 5.00000E-01 mev
5.00000E-01 to 1.00000E+00 mev
1.00000E+00 to 2.00000E+00 mev
2.00000E+00 to 3.00000E+00 mev
3.00000E+00 to 4.00000E+00 mev
4.00000E+00 to 5.00000E+00 mev
5.00000E+00 to 6.00000E+00 mev
6.00000E+00 to 7.00000E+00 mev
7.00000E+00 to 8.00000E+00 mev
8.00000E+00 to 9.00000E+00 mev
9.00000E+00 to 1.00000E+01 mev
1.00000E+01 to 1.10000E+01 mev
1.10000E+01 to 1.20000E+01 mev
1.20000E+01 to 1.30000E+01 mev
1.30000E+01 to 1.40000E+01 mev
1.40000E+01 to 1.50000E+01 mev
total bin
```

SKIP 158 LINES IN OUTPUT

**X** Imaterial composition

print table 40

material  
number component nuclide, atom fraction

```
1 1001, 8.47636E-02 8016, 6.04086E-01 11023, 9.47250E-03 12000, 2.99826E-03
```

13027, 2.48344E-02 14000, 2.41860E-01 19000, 6.85513E-03 20000, 2.04808E-02  
 26054, 2.74322E-04 26056, 4.26455E-03 26057, 9.76401E-05 26058, 1.30187E-05

material  
 number component nuclide, mass fraction

1 1001, 4.53200E-03 8016, 5.12597E-01 11023, 1.15530E-02 12000, 3.86599E-03  
 13027, 3.55480E-02 14000, 3.60364E-01 19000, 1.42190E-02 20000, 4.35460E-02  
 26054, 7.84990E-04 26056, 1.26547E-02 26057, 2.94921E-04 26058, 4.00121E-05

print table 50

X lcell volumes and masses

N11

cell	atom density	gram density	input volume	calculated volume	mass	pieces	reason volume not calculated
1	0.00000E+00	0.00000E+00	0.00000E+00	0.00000E+00	0.00000E+00	0	infinite
2	7.18983E-02	2.25050E+00	0.00000E+00	1.10447E+05	2.48560E+05	1	
3	7.18983E-02	2.25050E+00	0.00000E+00	1.10447E+05	2.48560E+05	1	
4	7.18983E-02	2.25050E+00	0.00000E+00	1.10447E+05	2.48560E+05	1	
5	7.18983E-02	2.25050E+00	0.00000E+00	1.10447E+05	2.48560E+05	1	
6	7.18983E-02	2.25050E+00	0.00000E+00	1.10447E+05	2.48560E+05	1	
7	7.18983E-02	2.25050E+00	0.00000E+00	1.10447E+05	2.48560E+05	1	
8	7.18983E-02	2.25050E+00	0.00000E+00	1.10447E+05	2.48560E+05	1	
9	7.18983E-02	2.25050E+00	0.00000E+00	1.10447E+05	2.48560E+05	1	
10	7.18983E-02	2.25050E+00	0.00000E+00	1.10447E+05	2.48560E+05	1	
11	7.18983E-02	2.25050E+00	0.00000E+00	1.10447E+05	2.48560E+05	1	
12	7.18983E-02	2.25050E+00	0.00000E+00	1.10447E+05	2.48560E+05	1	
13	7.18983E-02	2.25050E+00	0.00000E+00	1.10447E+05	2.48560E+05	1	
14	7.18983E-02	2.25050E+00	0.00000E+00	1.10447E+05	2.48560E+05	1	
15	7.18983E-02	2.25050E+00	0.00000E+00	1.10447E+05	2.48560E+05	1	
16	7.18983E-02	2.25050E+00	0.00000E+00	1.10447E+05	2.48560E+05	1	
17	7.18983E-02	2.25050E+00	0.00000E+00	1.10447E+05	2.48560E+05	1	

print table 50

X lsurface areas

surface	input area	calculated area	reason area not calculated
1	0.00000E+00	4.71239E+04	
2	0.00000E+00	1.76715E+04	
3	0.00000E+00	1.76715E+04	
4	0.00000E+00	1.76715E+04	
5	0.00000E+00	1.76715E+04	
6	0.00000E+00	1.76715E+04	
7	0.00000E+00	1.76715E+04	
8	0.00000E+00	1.76715E+04	

CHAPTER 5  
TEST1 PROBLEM AND OUTPUT

print table 60

X lcells

cell	mat	atom density	gram density	volume	mass	pieces	neutron importance	photon importance	photon wt generation
9	0	0.00000E+00	1.76715E+04	0.00000E+00	0.00000E+00	0	0.0000E+00	0.0000E+00	0.000E+00
10	0	0.00000E+00	1.76715E+04	1.10447E+05	2.48560E+05	1	1.0000E+00	1.0000E+00	-1.000E+01
11	0	0.00000E+00	1.76715E+04	1.10447E+05	2.48560E+05	1	1.0000E+00	1.0000E+00	-9.000E+00
12	0	0.00000E+00	1.76715E+04	1.10447E+05	2.48560E+05	1	1.0000E+00	1.0000E+00	-8.000E+00
13	0	0.00000E+00	1.76715E+04	1.10447E+05	2.48560E+05	1	1.0000E+00	1.0000E+00	-7.000E+00
14	0	0.00000E+00	1.76715E+04	1.10447E+05	2.48560E+05	1	1.0000E+00	1.0000E+00	-6.000E+00
15	0	0.00000E+00	1.76715E+04	1.10447E+05	2.48560E+05	1	1.0000E+00	1.0000E+00	-5.000E+00
16	0	0.00000E+00	1.76715E+04	1.10447E+05	2.48560E+05	1	2.0000E+00	2.0000E+00	-4.000E+00
17	0	0.00000E+00	1.76715E+04	1.10447E+05	2.48560E+05	1	2.0000E+00	2.0000E+00	-3.000E+00
18	0	0.00000E+00	1.76715E+04	1.10447E+05	2.48560E+05	1	2.0000E+00	2.0000E+00	-2.000E+00
19	0	0.00000E+00	1.76715E+04	1.10447E+05	2.48560E+05	1	4.0000E+00	4.0000E+00	-1.700E+00
20	0	0.00000E+00	1.76715E+04	1.10447E+05	2.48560E+05	1	4.0000E+00	4.0000E+00	-1.400E+00
21	0	0.00000E+00	1.76715E+04	1.10447E+05	2.48560E+05	1	4.0000E+00	4.0000E+00	-1.000E+00
22	0	0.00000E+00	1.76715E+04	1.10447E+05	2.48560E+05	1	8.0000E+00	8.0000E+00	-7.000E-01
23	0	0.00000E+00	1.76715E+04	1.10447E+05	2.48560E+05	1	8.0000E+00	8.0000E+00	-4.000E-01
24	0	0.00000E+00	1.76715E+04	1.10447E+05	2.48560E+05	1	1.6000E+01	1.6000E+01	-3.000E-01
25	0	0.00000E+00	1.76715E+04	1.10447E+05	2.48560E+05	1	3.2000E+01	3.2000E+01	-2.000E-01

N12total 1.76715E+06 3.97696E+06

X lsurfaces

print table 70

N13 surface trans type surface coefficients

1	1	cy	7.5000000E+01
2	2	py	0.0000000E+00
3	3	py	6.2500000E+00
4	4	py	1.2500000E+01
5	5	py	1.8750000E+01
6	6	py	2.5000000E+01
7	7	py	3.1250000E+01
8	8	py	3.7500000E+01
9	9	py	4.3750000E+01
10	10	py	5.0000000E+01
11	11	py	5.6250000E+01

```

12      12      PY      6.2500000E+01
13      13      PY      6.8750000E+01
14      14      PY      7.5000000E+01
15      15      PY      8.1250000E+01
16      16      PY      8.7500000E+01
17      17      PY      9.3750000E+01
18      18      PY      1.0000000E+02

```

1 cell temperatures in mev for the free-gas thermal neutron treatment. print table 72

**N14** all non-zero importance cells with materials have a temperature for thermal neutrons of 2.5300E-08 mev.  
 minimum source weight = 1.0000E+00 maximum source weight = 1.0000E+00

3 warning messages so far. print table 98  
**N15**physical constants

name	value	description
huge	1.0000000000000E+37	infinity
pie	3.1415926535898E+00	pi
euler	5.7721566490153E-01	euler constant
avogad	6.0220434469282E+23	avogadro number (molecules/mole)
aneut	1.0086649670000E+00	neutron mass (amu)
avgdn	5.9703109000000E-01	avogadro number/neutron mass (1.e-24*molecules/mole/amu)
slite	2.9979250000000E+02	speed of light (cm/shake)
planck	4.1357320000000E-13	planck constant (mev shake)
fscon	1.3703930000000E+02	inverse fine structure constant h*c/(2*pi*e**2)
gpt(1)	9.3958000000000E+02	neutron mass (mev)
gpt(3)	5.1100800000000E-01	electron mass (mev)

fission q-values:	nuclide	q(mev)	nuclide	q(mev)
	90232	171.91	91233	175.57
	92233	180.84	92234	179.45
	92235	180.88	92236	179.50
	92237	180.40	92238	181.31
	92239	180.40	92240	180.40
	93237	183.67	94238	186.65
	94239	189.44	94240	186.36
	94241	188.99	94242	185.98
	94243	187.48	95241	190.83
	95242	190.54	95243	190.25
	96242	190.49	96244	190.49
	other	180.00		

the following compilation options were used:

pointer



# CHAPTER 5

## TEST1 PROBLEM AND OUTPUT

```
cheap
unix
sun
plot
mcplot
gkssim
xlib
xs64
```

```
default datapath: /usr/local/codes/data/mc/type2/unix64
```

### N16 cross-section tables

```
print table 100
```

```
table length
```

```
tables from file endf602
```

1001.60c	2322	1-h-1	from endf-vi.1						
8016.60c	50346	8-o-16	from endf/b-vi				mat 125		11/25/93
11023.60c	48471	11-na-23	from endf/b-vi.1				mat1125		11/25/93
12000.60c	52785	12-mg-nat	from endf/b-vi				mat1200		11/25/93
13027.60c	49407	13-al-27	from endf/b-vi				mat1325		11/25/93
14000.60c	100118	14-si-nat	from endf/b-vi				mat1400		11/25/93
19000.60c	23390	19-k-nat	from endf/b-vi				mat1900		11/25/93
20000.60c	70573	20-ca-nat	from endf/b-vi				mat2000		11/25/93
26054.60c	120443	endf/b-vi.1	fe54a				mat2625		11/25/93
26056.60c	172174	endf/b-vi.1	fe56a				mat2631		11/25/93
26057.60c	133044	endf/b-vi.1	fe57a				mat2634		11/25/93
26058.60c	92535	endf/b-vi.1	fe58a				mat2637		11/25/93

```
tables from file mcplib022
```

1000.02p	623								01/15/93
8000.02p	623								01/15/93
11000.02p	635								01/15/93
12000.02p	643								01/15/93
13000.02p	643								01/15/93
14000.02p	643								01/15/93
19000.02p	643								01/15/93
20000.02p	651								01/15/93
26000.02p	651								01/15/93
total	921363								

**N17** any neutrons with energy greater than emax = 1.50000E+01 from the source or from a collision will be resampled.

**N18** neutron cross sections outside the range from 0.0000E+00 to 1.5000E+01 mev are expunged.

maximum photon energy set to 100.0 mev (maximum electron energy)

tables from file el032

1000.03e	2329	6/6/98
8000.03e	2333	6/6/98
11000.03e	2337	6/6/98
12000.03e	2337	6/6/98
13000.03e	2337	6/6/98
14000.03e	2339	6/6/98
19000.03e	2343	6/6/98
20000.03e	2343	6/6/98
26000.03e	2345	6/6/98

print table 85

**X** lrange table for material 1 (condensed)

electron substeps per energy step = 4, default = 4. mean ionization energy = 1.41099E+02 ev.

**N19**X density effect data  
non-conductor

z = 1	
occ no, be(ev) pairs	
1.	13.600
z = 8	
occ no, be(ev) pairs	
2.	538.000
2.	28.480
4.	13.620
z = 11	
occ no, be(ev) pairs	
2.	1075.000
2.	66.000
2.	34.000
4.	34.000
4.	-1.
5.139	
z = 12	
occ no, be(ev) pairs	
2.	1308.000
2.	92.000
2.	54.000
4.	54.000
4.	-2.
7.646	
z = 13	
occ no, be(ev) pairs	
2.	1564.000
2.	121.000
2.	77.000
4.	77.000
4.	-3.
9.075	
z = 14	
occ no, be(ev) pairs	
2.	1844.000
2.	154.000
2.	104.000
4.	104.000
4.	2.
13.460	
z = 19	
occ no, be(ev) pairs	
2.	3610.000
2.	381.000
2.	299.000
4.	296.000
4.	2.
37.000	
z = 20	
occ no, be(ev) pairs	
2.	4041.000
2.	441.000
2.	353.000
4.	349.000
4.	2.
46.000	
z = 26	
occ no, be(ev) pairs	
2.	7117.000
2.	851.000
2.	726.000
4.	713.000
4.	2.
98.000	
z = 26	
occ no, be(ev) pairs	
2.	59.000
6.	9.000
-2.	7.870
2.	98.000
2.	61.000

CHAPTER 5  
TEST1 PROBLEM AND OUTPUT

```

occ no, be(ev) pairs
2. 7117.000 2. 851.000 2. 726.000 4. 713.000 2. 98.000 2. 61.000
4. 59.000 6. 9.000 -2. 7.870

z = 26
occ no, be(ev) pairs
2. 7117.000 2. 851.000 2. 726.000 4. 713.000 2. 98.000 2. 61.000
4. 59.000 6. 9.000 -2. 7.870

z = 26
occ no, be(ev) pairs
2. 7117.000 2. 851.000 2. 726.000 4. 713.000 2. 98.000 2. 61.000
4. 59.000 6. 9.000 -2. 7.870
plas(ev) wt tmin(mev)
30.57106 2.35209 0.36478

```

**N20**

n	energy mev	stopping power mev cm2/g	radiation mev cm2/g	total mev cm2/g	range g/cm2	radiation yield	beta**2 corr	density mev cm2/g	rad/col g/cm2	drange	dyield
133	1.0790E-03	7.975E+01	3.695E-03	7.976E+01	7.021E-06	3.708E-06	4.210E-03	0.000E+00	4.633E-05	1.098E-06	4.000E-09
132	1.1766E-03	7.605E+01	3.798E-03	7.605E+01	8.276E-06	7.395E-06	4.589E-03	0.000E+00	4.994E-05	1.254E-06	4.700E-09
131	1.2831E-03	7.241E+01	3.900E-03	7.242E+01	9.711E-06	1.109E-05	5.003E-03	0.000E+00	5.386E-05	1.435E-06	5.527E-09
130	1.3992E-03	6.886E+01	4.003E-03	6.887E+01	1.136E-05	1.482E-05	5.454E-03	0.000E+00	5.813E-05	1.645E-06	6.502E-09
129	1.5259E-03	6.540E+01	4.105E-03	6.541E+01	1.324E-05	1.860E-05	5.945E-03	0.000E+00	6.276E-05	1.888E-06	7.655E-09
128	1.6640E-03	6.205E+01	4.207E-03	6.205E+01	1.541E-05	2.248E-05	6.481E-03	0.000E+00	6.780E-05	2.169E-06	9.015E-09
127	1.8146E-03	5.880E+01	4.308E-03	5.881E+01	1.791E-05	2.646E-05	7.064E-03	0.000E+00	7.327E-05	2.494E-06	1.062E-08

SKIP 122 LINES IN OUTPUT

n	energy mev	stopping power mev cm2/g	radiation mev cm2/g	total mev cm2/g	range g/cm2	radiation yield	beta**2 corr	density mev cm2/g	rad/col g/cm2	drange	dyield
4	7.7111E-01	1.906E+00	2.563E+00	4.469E+00	2.757E+01	3.582E-01	1.000E+00	4.644E-01	1.344E+00	1.471E+00	3.600E+00
3	8.4090E-01	1.914E+00	2.814E+00	4.728E+00	2.909E+01	3.769E-01	1.000E+00	4.770E-01	1.471E+00	1.518E+00	4.079E+00
2	9.1700E-01	1.921E+00	3.089E+00	5.010E+00	3.065E+01	3.960E-01	1.000E+00	4.898E-01	1.608E+00	1.564E+00	4.613E+00
1	1.0000E+02	1.928E+00	3.390E+00	5.318E+00	3.226E+01	4.152E-01	1.000E+00	5.025E-01	1.759E+00	1.608E+00	5.206E+00

**N21**electron secondary production for material 1

n	energy mev	stopping power mev barn	radiation mev barn	total mev barn	brems barn	thick tgt barn	tgt barn	k x-ray barn	knock-on barn
133	1.0790E-03	2.496E+03	1.157E-01	2.496E+03	1.398E+03	5.031E-05	0.000E+00	0.000E+00	0.000E+00
132	1.1766E-03	2.380E+03	1.189E-01	2.381E+03	1.327E+03	1.049E-04	0.000E+00	0.000E+00	0.000E+00
131	1.2831E-03	2.267E+03	1.221E-01	2.267E+03	1.259E+03	1.642E-04	0.000E+00	0.000E+00	0.000E+00
130	1.3992E-03	2.155E+03	1.253E-01	2.156E+03	1.193E+03	2.286E-04	0.000E+00	0.000E+00	0.000E+00
129	1.5259E-03	2.047E+03	1.285E-01	2.047E+03	1.130E+03	2.987E-04	0.000E+00	0.000E+00	0.000E+00
128	1.6640E-03	1.942E+03	1.317E-01	1.942E+03	1.070E+03	3.749E-04	0.000E+00	0.000E+00	0.000E+00
127	1.8146E-03	1.841E+03	1.349E-01	1.841E+03	1.012E+03	4.578E-04	0.000E+00	0.000E+00	0.000E+00

SKIP 122 LINES IN OUTPUT

n	energy mev	stopping power mev barn	radiation mev barn	total mev barn	brems barn	thick tgt barn	tgt barn	k x-ray barn	knock-on barn
4	7.7111E-01	5.967E+01	8.022E+01	1.399E+02	2.275E+01	1.986E+01	1.596E+00	2.409E+03	1.613E+00
3	8.4090E-01	5.990E+01	8.808E+01	1.480E+02	2.275E+01	2.097E+01	1.613E+00	2.409E+03	1.629E+00
2	9.1700E-01	6.012E+01	9.670E+01	1.568E+02	2.274E+01	2.210E+01	1.629E+00	2.409E+03	1.645E+00
1	1.0000E+02	6.035E+01	1.061E+02	1.665E+02	2.274E+01	2.327E+01	1.645E+00	2.409E+03	1.645E+00

print table 86

1decimal words of dynamically allocated storage

general 148616  
tallies 47160  
bank 46724  
cross sections 1842726

total 2058178 = 8232712 bytes

\*\*\*\*\*

**N22** dump no. 1 on file test1.r nps = 0 coll = 0 ctm = 0.00 nrn = 0

3 warning messages so far.

**X** 1 starting mcrun. dynamic storage = 2058182 words, 8232728 bytes. cp0 = 0.12 print table 110

**N23** test1: 100 cm thick concrete disk with 15 splitting surfaces

nps	x	y	z	cell	surf	u	v	w	energy	weight	time
1	0.000E+00	0.000E+00	0.000E+00	2	2	0.000E+00	1.000E+00	0.000E+00	1.419E+01	1.000E+00	0.000E+00
2	0.000E+00	0.000E+00	0.000E+00	2	2	0.000E+00	1.000E+00	0.000E+00	1.419E+01	1.000E+00	0.000E+00
3	0.000E+00	0.000E+00	0.000E+00	2	2	0.000E+00	1.000E+00	0.000E+00	1.419E+01	1.000E+00	0.000E+00
4	0.000E+00	0.000E+00	0.000E+00	2	2	0.000E+00	1.000E+00	0.000E+00	1.419E+01	1.000E+00	0.000E+00
5	0.000E+00	0.000E+00	0.000E+00	2	2	0.000E+00	1.000E+00	0.000E+00	1.419E+01	1.000E+00	0.000E+00
6	0.000E+00	0.000E+00	0.000E+00	2	2	0.000E+00	1.000E+00	0.000E+00	1.419E+01	1.000E+00	0.000E+00
7	0.000E+00	0.000E+00	0.000E+00	2	2	0.000E+00	1.000E+00	0.000E+00	1.419E+01	1.000E+00	0.000E+00
8	0.000E+00	0.000E+00	0.000E+00	2	2	0.000E+00	1.000E+00	0.000E+00	1.419E+01	1.000E+00	0.000E+00
9	0.000E+00	0.000E+00	0.000E+00	2	2	0.000E+00	1.000E+00	0.000E+00	1.419E+01	1.000E+00	0.000E+00
10	0.000E+00	0.000E+00	0.000E+00	2	2	0.000E+00	1.000E+00	0.000E+00	1.419E+01	1.000E+00	0.000E+00
11	0.000E+00	0.000E+00	0.000E+00	2	2	0.000E+00	1.000E+00	0.000E+00	1.419E+01	1.000E+00	0.000E+00
12	0.000E+00	0.000E+00	0.000E+00	2	2	0.000E+00	1.000E+00	0.000E+00	1.419E+01	1.000E+00	0.000E+00
13	0.000E+00	0.000E+00	0.000E+00	2	2	0.000E+00	1.000E+00	0.000E+00	1.419E+01	1.000E+00	0.000E+00
14	0.000E+00	0.000E+00	0.000E+00	2	2	0.000E+00	1.000E+00	0.000E+00	1.419E+01	1.000E+00	0.000E+00
15	0.000E+00	0.000E+00	0.000E+00	2	2	0.000E+00	1.000E+00	0.000E+00	1.419E+01	1.000E+00	0.000E+00
16	0.000E+00	0.000E+00	0.000E+00	2	2	0.000E+00	1.000E+00	0.000E+00	1.419E+01	1.000E+00	0.000E+00
17	0.000E+00	0.000E+00	0.000E+00	2	2	0.000E+00	1.000E+00	0.000E+00	1.419E+01	1.000E+00	0.000E+00
18	0.000E+00	0.000E+00	0.000E+00	2	2	0.000E+00	1.000E+00	0.000E+00	1.419E+01	1.000E+00	0.000E+00
19	0.000E+00	0.000E+00	0.000E+00	2	2	0.000E+00	1.000E+00	0.000E+00	1.419E+01	1.000E+00	0.000E+00
20	0.000E+00	0.000E+00	0.000E+00	2	2	0.000E+00	1.000E+00	0.000E+00	1.419E+01	1.000E+00	0.000E+00
21	0.000E+00	0.000E+00	0.000E+00	2	2	0.000E+00	1.000E+00	0.000E+00	1.419E+01	1.000E+00	0.000E+00
22	0.000E+00	0.000E+00	0.000E+00	2	2	0.000E+00	1.000E+00	0.000E+00	1.419E+01	1.000E+00	0.000E+00
23	0.000E+00	0.000E+00	0.000E+00	2	2	0.000E+00	1.000E+00	0.000E+00	1.419E+01	1.000E+00	0.000E+00
24	0.000E+00	0.000E+00	0.000E+00	2	2	0.000E+00	1.000E+00	0.000E+00	1.419E+01	1.000E+00	0.000E+00
25	0.000E+00	0.000E+00	0.000E+00	2	2	0.000E+00	1.000E+00	0.000E+00	1.419E+01	1.000E+00	0.000E+00
26	0.000E+00	0.000E+00	0.000E+00	2	2	0.000E+00	1.000E+00	0.000E+00	1.419E+01	1.000E+00	0.000E+00
27	0.000E+00	0.000E+00	0.000E+00	2	2	0.000E+00	1.000E+00	0.000E+00	1.419E+01	1.000E+00	0.000E+00

# CHAPTER 5

## TEST1 PROBLEM AND OUTPUT

```

28 0.000E+00 0.000E+00 0.000E+00 2 2 0.000E+00 1.000E+00 0.000E+00 1.419E+01 1.000E+00 0.000E+00 0.000E+00
29 0.000E+00 0.000E+00 0.000E+00 2 2 0.000E+00 1.000E+00 0.000E+00 1.419E+01 1.000E+00 0.000E+00 0.000E+00
30 0.000E+00 0.000E+00 0.000E+00 2 2 0.000E+00 1.000E+00 0.000E+00 1.419E+01 1.000E+00 0.000E+00 0.000E+00
31 0.000E+00 0.000E+00 0.000E+00 2 2 0.000E+00 1.000E+00 0.000E+00 1.419E+01 1.000E+00 0.000E+00 0.000E+00
32 0.000E+00 0.000E+00 0.000E+00 2 2 0.000E+00 1.000E+00 0.000E+00 1.419E+01 1.000E+00 0.000E+00 0.000E+00
33 0.000E+00 0.000E+00 0.000E+00 2 2 0.000E+00 1.000E+00 0.000E+00 1.419E+01 1.000E+00 0.000E+00 0.000E+00
34 0.000E+00 0.000E+00 0.000E+00 2 2 0.000E+00 1.000E+00 0.000E+00 1.419E+01 1.000E+00 0.000E+00 0.000E+00
35 0.000E+00 0.000E+00 0.000E+00 2 2 0.000E+00 1.000E+00 0.000E+00 1.419E+01 1.000E+00 0.000E+00 0.000E+00
36 0.000E+00 0.000E+00 0.000E+00 2 2 0.000E+00 1.000E+00 0.000E+00 1.419E+01 1.000E+00 0.000E+00 0.000E+00
37 0.000E+00 0.000E+00 0.000E+00 2 2 0.000E+00 1.000E+00 0.000E+00 1.419E+01 1.000E+00 0.000E+00 0.000E+00
38 0.000E+00 0.000E+00 0.000E+00 2 2 0.000E+00 1.000E+00 0.000E+00 1.419E+01 1.000E+00 0.000E+00 0.000E+00
39 0.000E+00 0.000E+00 0.000E+00 2 2 0.000E+00 1.000E+00 0.000E+00 1.419E+01 1.000E+00 0.000E+00 0.000E+00
40 0.000E+00 0.000E+00 0.000E+00 2 2 0.000E+00 1.000E+00 0.000E+00 1.419E+01 1.000E+00 0.000E+00 0.000E+00
41 0.000E+00 0.000E+00 0.000E+00 2 2 0.000E+00 1.000E+00 0.000E+00 1.419E+01 1.000E+00 0.000E+00 0.000E+00
42 0.000E+00 0.000E+00 0.000E+00 2 2 0.000E+00 1.000E+00 0.000E+00 1.419E+01 1.000E+00 0.000E+00 0.000E+00
43 0.000E+00 0.000E+00 0.000E+00 2 2 0.000E+00 1.000E+00 0.000E+00 1.419E+01 1.000E+00 0.000E+00 0.000E+00
44 0.000E+00 0.000E+00 0.000E+00 2 2 0.000E+00 1.000E+00 0.000E+00 1.419E+01 1.000E+00 0.000E+00 0.000E+00
45 0.000E+00 0.000E+00 0.000E+00 2 2 0.000E+00 1.000E+00 0.000E+00 1.419E+01 1.000E+00 0.000E+00 0.000E+00
46 0.000E+00 0.000E+00 0.000E+00 2 2 0.000E+00 1.000E+00 0.000E+00 1.419E+01 1.000E+00 0.000E+00 0.000E+00
47 0.000E+00 0.000E+00 0.000E+00 2 2 0.000E+00 1.000E+00 0.000E+00 1.419E+01 1.000E+00 0.000E+00 0.000E+00
48 0.000E+00 0.000E+00 0.000E+00 2 2 0.000E+00 1.000E+00 0.000E+00 1.419E+01 1.000E+00 0.000E+00 0.000E+00
49 0.000E+00 0.000E+00 0.000E+00 2 2 0.000E+00 1.000E+00 0.000E+00 1.419E+01 1.000E+00 0.000E+00 0.000E+00
50 0.000E+00 0.000E+00 0.000E+00 2 2 0.000E+00 1.000E+00 0.000E+00 1.419E+01 1.000E+00 0.000E+00 0.000E+00
lproblem summary
run terminated when 10000 particle histories were done.
+
test1: 100 cm thick concrete disk with 15 splitting surfaces 06/23/00 11:34:29
0
N24neutron creation tracks weight energy neutron loss tracks weight energy
(per source particle) (per source particle)
source 10000 1.0000E+00 1.4190E+01 N27escape 13411 4.0545E-01 9.9156E-01
energy cutoff energy cutoff
time cutoff time cutoff
weight window weight window
N25cell importance 35681 2.5286E-01 9.6306E-02 N28cell importance 23893 2.5427E-01 1.0282E-01
N26weight cutoff 0 8.1018E-02 5.4609E-02 N29weight cutoff 8625 8.0533E-02 5.5477E-02
energy importance energy importance
dxtran dxtran
forced collisions forced collisions
exp. transform exp. transform
upscattering 0 0. 1.0851E-07 N30downscattering 0 0. 8.2722E+00
delayed fission 0 0. 0. N31capture 0 6.0858E-01 4.7835E+00
(n,xn) 496 2.9921E-02 7.3027E-02 loss to (n,xn) 248 1.4960E-02 2.0833E-01
prompt fission 0 0. 0. loss to fission 0 0. 0.
total 46177 1.3638E+00 1.4414E+01 N32 total 46177 1.3638E+00 1.4414E+01

```

number of neutrons banked 35929  
 neutron tracks per source particle 4.6177E+00  
 neutron collisions per source particle 1.1440E+02  
 total neutron collisions 1143962  
**N34**net multiplication 1.0150E+00 0.0010  
 0

photon creation tracks weight energy  
 (per source particle)

source 0 0. 0. 0.  
 weight window 0 0. 0.  
 cell importance 9943 1.3568E-01 1.4838E-01  
 weight cutoff 0 4.8911E-02 4.7908E-03  
 energy importance 0 0. 0.  
 dxtran 0 0. 0.  
 forced collisions 0 0. 0.  
 exp. transform 0 0. 0.  
 from neutrons 14595 1.9430E+00 6.1915E+00  
 bremsstrahlung 20279 9.0128E-01 8.9382E-02  
**N35**-annihilation 1998 2.7534E-01 1.4070E-01  
 electron x-rays 0 0. 0.  
 1st fluorescence 0 0. 0.  
 2nd fluorescence 0 0. 0.  
 total 46815 3.3043E+00 6.5747E+00

**N33**average time of (shakes) cutoffs  
 escape 6.2490E+03 tco 1.0000E+34  
 capture 1.6237E+04 eco 0.0000E+00  
 capture or escape 1.2243E+04 wcl -5.0000E-01  
 any termination 1.7300E+04 wc2 -2.5000E-01

photon loss tracks weight energy  
 (per source particle)

escape 7391 5.1898E-01 1.0525E+00  
 energy cutoff 0 0. 0.  
 time cutoff 0 0. 0.  
 weight window 0 0. 0.  
 cell importance 6205 1.4357E-01 1.6084E-01  
 weight cutoff 32220 5.0010E-02 4.9142E-03  
 energy importance 0 0. 0.  
 dxtran 0 0. 0.  
 forced collisions 0 0. 0.  
 exp. transform 0 0. 0.  
 compton scatter 0 0. 4.4296E+00  
 capture 0 2.4540E+00 1.4688E-01  
 pair production 999 1.3767E-01 7.8001E-01  
 total 46815 3.3043E+00 6.5747E+00

number of photons banked 45816  
 photon tracks per source particle 4.6815E+00  
 photon collisions per source particle 1.7059E+01  
 total photon collisions 170585  
 computer time so far in this run 6.70 minutes  
 computer time in mcrun 3.29 minutes  
 source particles per minute 3.0400E+03  
 random numbers generated 20699414  
 range of sampled source weights = 1.0000E+00 to 1.0000E+00  
 ln neutron activity in each cell

**N36** average time of (shakes) cutoffs  
 escape 7.1788E+03 tco 1.0000E+34  
 capture 1.1333E+04 eco 1.0000E-03  
 capture or escape 1.0608E+04 wcl -5.0000E-01  
 any termination 1.0995E+04 wc2 -2.5000E-01  
 maximum number ever in bank 30  
 bank overflows to backup file 0  
 dynamic storage 2058182 words, 8232728 bytes.  
 most random numbers used was 49909 in history 7348

collisions \* weight (per history) collisions population tracks entering cell

cell	tracks entering	population	collisions	collisions * weight (per history)
2	18335	10493	43171	2.8559E+00
3	21618	9090	64201	3.8597E+00

flux weighted energy number weighted energy  
 average track weight (relative) average track mfp (cm)  
 6.7719E+00 6.4317E-03 4.3317E-03 6.7719E+00 7.2919E-01 6.4461E+00  
 4.4117E+00 4.4117E+00 1.8065E-03 4.4117E+00 6.4965E-01 5.5031E+00

print table 126

# CHAPTER 5

## TEST1 PROBLEM AND OUTPUT

5-22

cell	4	5	6	7	8	9	10	11	12	13	14	15	16	17	total
tracks entering	22171	21004	18634	15941	25940	20450	16178	24770	18448	13562	19237	12669	15238	13964	298159
population	8049	7371	7005	7715	13029	8738	8132	12543	7887	7038	10654	7187	10976	11774	147681
collisions	74156	76022	70710	62015	103223	83591	67245	104079	78368	57418	81605	53795	65726	58637	1143962
collisions * weight (per history)	4.1862E+00	4.1000E+00	3.6435E+00	3.0870E+00	2.4867E+00	1.9533E+00	1.5263E+00	1.1670E+00	6.6360E-01	6.1837E-01	4.3278E-01	2.8142E-01	1.7060E-01	7.6169E-02	3.14309E+01
number weighted energy	1.0093E-03	6.3848E-04	4.2679E-04	3.1639E-04	2.3767E-04	1.9586E-04	1.5952E-04	1.3360E-04	1.1375E-04	9.7234E-05	8.6184E-05	8.2713E-05	8.7605E-05	1.0658E-04	3.1309E+01
flux weighted energy	3.1694E+00	2.4071E+00	1.8468E+00	1.4970E+00	1.2220E+00	1.0554E+00	8.8762E-01	7.5248E-01	6.5578E-01	5.8251E-01	5.2830E-01	5.0187E-01	5.2869E-01	6.3919E-01	1.93998E+00
average track mfp (cm)	4.9011E+00	4.5125E+00	4.1749E+00	3.9409E+00	3.7443E+00	3.6338E+00	3.5113E+00	3.4174E+00	3.3338E+00	3.2583E+00	3.2085E+00	3.1945E+00	3.2366E+00	3.3528E+00	3.3528E+00

### N37

lphoton activity in each cell

### N38

### N39

### N40

### N41

### N42

### N43

### N44

print table 126

cell	2	3	4	5	6	7	8	9	10	11	12	13	14	15	16	17	total
collisions	3165	5257	5440	5157	4819	4174	8015	7305	6274	12135	11015	10925	19249	16119	23766	27770	170585
collisions * weight (per history)	1.9102E+00	2.8973E+00	2.7612E+00	2.3396E+00	1.9547E+00	1.4558E+00	1.2345E+00	8.8062E-01	6.2921E-01	4.7280E-01	3.7026E-01	2.9309E-01	1.9942E-01	1.3955E-01	8.7332E-02	4.8320E-02	1.7674E+01
number weighted energy	1.7128E+00	1.5538E+00	1.4754E+00	1.4202E+00	1.3651E+00	1.5056E+00	1.3998E+00	1.3206E+00	1.3613E+00	1.3471E+00	1.3603E+00	1.3062E+00	1.3322E+00	1.3791E+00	1.3893E+00	1.4586E+00	1.4586E+00
flux weighted energy	1.7128E+00	1.5538E+00	1.4754E+00	1.4202E+00	1.3651E+00	1.5056E+00	1.3998E+00	1.3206E+00	1.3613E+00	1.3471E+00	1.3603E+00	1.3062E+00	1.3322E+00	1.3791E+00	1.3893E+00	1.4586E+00	1.4586E+00
average weight (relative)	7.7437E+00	7.1560E+00	6.5959E+00	5.8593E+00	5.1434E+00	4.3974E+00	3.7583E+00	2.9399E+00	2.3435E+00	1.8650E+00	1.5276E+00	1.2124E+00	9.3212E-01	7.4475E-01	6.2711E-01	5.8386E-01	5.8386E-01
average track mfp (cm)	7.5138E+00	7.0346E+00	6.8331E+00	6.7537E+00	6.6591E+00	6.9473E+00	6.6404E+00	6.5022E+00	6.5900E+00	6.5684E+00	6.6002E+00	6.4108E+00	6.5211E+00	6.6435E+00	6.7138E+00	6.9410E+00	6.9410E+00

### N45

### N46

X Ineutron weight balance in each cell -- external events

print table 130

cell	2	3	4	5	6	7	8	9	10	11	12	13	14	15	16	17	total
weight balance in each cell	47689	73360	170585	170585	170585	170585	170585	170585	170585	170585	170585	170585	170585	170585	170585	170585	170585
entering	5.0025E-01	1.5253E+00	1.4169E+00	1.0000E+00	0.0000E+00	0.0000E+00	0.0000E+00	0.0000E+00	0.0000E+00	0.0000E+00	0.0000E+00	0.0000E+00	0.0000E+00	0.0000E+00	0.0000E+00	0.0000E+00	0.0000E+00
source	1.0000E+00	0.0000E+00	0.0000E+00	0.0000E+00	0.0000E+00	0.0000E+00	0.0000E+00	0.0000E+00	0.0000E+00	0.0000E+00	0.0000E+00	0.0000E+00	0.0000E+00	0.0000E+00	0.0000E+00	0.0000E+00	0.0000E+00
energy cutoff	0.0000E+00	0.0000E+00	0.0000E+00	0.0000E+00	0.0000E+00	0.0000E+00	0.0000E+00	0.0000E+00	0.0000E+00	0.0000E+00	0.0000E+00	0.0000E+00	0.0000E+00	0.0000E+00	0.0000E+00	0.0000E+00	0.0000E+00
time cutoff	0.0000E+00	0.0000E+00	0.0000E+00	0.0000E+00	0.0000E+00	0.0000E+00	0.0000E+00	0.0000E+00	0.0000E+00	0.0000E+00	0.0000E+00	0.0000E+00	0.0000E+00	0.0000E+00	0.0000E+00	0.0000E+00	0.0000E+00
exiting	-1.3773E+00	-1.4235E+00	-1.3346E+00	-1.3773E+00	-1.4235E+00	-1.3346E+00	-1.3773E+00	-1.4235E+00	-1.3346E+00	-1.3773E+00	-1.4235E+00	-1.3346E+00	-1.3773E+00	-1.4235E+00	-1.3346E+00	-1.3773E+00	-1.3773E+00
other	0.0000E+00	0.0000E+00	0.0000E+00	0.0000E+00	0.0000E+00	0.0000E+00	0.0000E+00	0.0000E+00	0.0000E+00	0.0000E+00	0.0000E+00	0.0000E+00	0.0000E+00	0.0000E+00	0.0000E+00	0.0000E+00	0.0000E+00
total	1.2300E-01	1.0178E-01	8.2296E-02	1.2300E-01	1.0178E-01	8.2296E-02	1.2300E-01	1.0178E-01	8.2296E-02	1.2300E-01	1.0178E-01	8.2296E-02	1.2300E-01	1.0178E-01	8.2296E-02	1.2300E-01	1.2300E-01

```

5 5 1.2472E+00 0.0000E+00 0.0000E+00 -1.1795E+00 0.0000E+00 6.7740E-02
6 6 1.0434E+00 0.0000E+00 0.0000E+00 -9.9146E-01 0.0000E+00 5.1938E-02
7 7 8.5224E-01 0.0000E+00 0.0000E+00 -8.0834E-01 0.0000E+00 4.3898E-02
8 8 6.6384E-01 0.0000E+00 0.0000E+00 -6.3099E-01 0.0000E+00 3.2856E-02
9 9 5.0444E-01 0.0000E+00 0.0000E+00 -4.7817E-01 0.0000E+00 2.6266E-02
10 10 3.8652E-01 0.0000E+00 0.0000E+00 -3.6796E-01 0.0000E+00 1.8566E-02
11 11 2.9006E-01 0.0000E+00 0.0000E+00 -2.7559E-01 0.0000E+00 1.4468E-02
12 12 2.1097E-01 0.0000E+00 0.0000E+00 -2.0013E-01 0.0000E+00 1.0842E-02
13 13 1.5138E-01 0.0000E+00 0.0000E+00 -1.4351E-01 0.0000E+00 7.8751E-03
14 14 1.0557E-01 0.0000E+00 0.0000E+00 -9.9876E-02 0.0000E+00 5.6967E-03
15 15 6.8826E-02 0.0000E+00 0.0000E+00 -6.4757E-02 0.0000E+00 4.0695E-03
16 16 4.0784E-02 0.0000E+00 0.0000E+00 -3.8564E-02 0.0000E+00 2.2201E-03
17 17 1.8644E-02 0.0000E+00 0.0000E+00 -1.7607E-02 0.0000E+00 1.0373E-03

total 9.0263E+00 1.0000E+00 0.0000E+00 -9.4317E+00 0.0000E+00 5.9455E-01
X neutron weight balance in each cell -- variance reduction events
print table 130

```

```

cell weight cell energy dxtran forced exponential total
window importance cutoff importance dxtran collision transform
2 2 0.0000E+00 0.0000E+00 8.1706E-05 0.0000E+00 0.0000E+00 0.0000E+00 -8.1706E-05
3 3 0.0000E+00 0.0000E+00 3.4900E-04 0.0000E+00 0.0000E+00 0.0000E+00 3.4900E-04
4 4 0.0000E+00 0.0000E+00 8.6370E-05 0.0000E+00 0.0000E+00 0.0000E+00 8.6370E-05
5 5 0.0000E+00 0.0000E+00 4.4060E-04 0.0000E+00 0.0000E+00 0.0000E+00 4.4060E-04
6 6 0.0000E+00 0.0000E+00 7.8845E-04 0.0000E+00 0.0000E+00 0.0000E+00 7.8845E-04
7 7 0.0000E+00 -1.9599E-03 -4.1174E-04 0.0000E+00 0.0000E+00 0.0000E+00 -2.3716E-03
8 8 0.0000E+00 0.0000E+00 -1.1306E-04 0.0000E+00 0.0000E+00 0.0000E+00 -1.1306E-04
9 9 0.0000E+00 0.0000E+00 -5.4611E-04 0.0000E+00 0.0000E+00 0.0000E+00 -5.4611E-04
10 10 0.0000E+00 8.1516E-04 0.0000E+00 0.0000E+00 0.0000E+00 0.0000E+00 7.8013E-04
11 11 0.0000E+00 0.0000E+00 6.2059E-05 0.0000E+00 0.0000E+00 0.0000E+00 6.2059E-05
12 12 0.0000E+00 0.0000E+00 2.2170E-05 0.0000E+00 0.0000E+00 0.0000E+00 2.2170E-05
13 13 0.0000E+00 7.2159E-05 -7.6281E-05 0.0000E+00 0.0000E+00 0.0000E+00 -4.1214E-06
14 14 0.0000E+00 0.0000E+00 -2.6033E-05 0.0000E+00 0.0000E+00 0.0000E+00 -2.6033E-05
15 15 0.0000E+00 -3.4469E-04 -1.1228E-05 0.0000E+00 0.0000E+00 0.0000E+00 -3.5592E-04
16 16 0.0000E+00 4.7893E-06 4.8176E-05 0.0000E+00 0.0000E+00 0.0000E+00 5.2965E-05
17 17 0.0000E+00 0.0000E+00 -1.1216E-05 0.0000E+00 0.0000E+00 0.0000E+00 -1.1216E-05

total 0.0000E+00 -1.4125E-03 4.8443E-04 0.0000E+00 0.0000E+00 0.0000E+00 -9.2803E-04
X neutron weight balance in each cell -- physical events
print table 130

```

```

cell (n,xn) fission capture loss to total
(n,xn) (n,xn) (n,xn) fission
2 2 1.2693E-02 0.0000E+00 -1.2926E-01 -6.3465E-03 0.0000E+00 -1.2292E-01
3 3 7.3045E-03 0.0000E+00 -1.0578E-01 -3.6522E-03 0.0000E+00 -1.0213E-01
4 4 4.5440E-03 0.0000E+00 -8.4654E-02 -2.2720E-03 0.0000E+00 -8.2382E-02
5 5 1.5039E-03 0.0000E+00 -6.8933E-02 -7.5196E-04 0.0000E+00 -6.8181E-02
6 6 1.0648E-03 0.0000E+00 -5.3259E-02 -5.3242E-04 0.0000E+00 -5.2727E-02

```



# CHAPTER 5

## TEST1 PROBLEM AND OUTPUT

print table 130

**X** 1photon weight balance in each cell -- external events

cell	entering	source	energy cutoff	time cutoff	exiting	other	total
7	1.2633E-03	0.0000E+00	-4.2158E-02	-6.3164E-04	0.0000E+00	-4.1526E-02	0.0000E+00
8	6.6219E-04	0.0000E+00	-3.3074E-02	-3.3109E-04	0.0000E+00	-3.2743E-02	0.0000E+00
9	4.0116E-04	0.0000E+00	-2.5921E-02	-2.0058E-04	0.0000E+00	-2.5720E-02	0.0000E+00
10	1.6792E-04	0.0000E+00	-1.9430E-02	-8.3959E-05	0.0000E+00	-1.9346E-02	0.0000E+00
11	6.9211E-05	0.0000E+00	-1.4564E-02	-3.4606E-05	0.0000E+00	-1.4530E-02	0.0000E+00
12	1.1235E-04	0.0000E+00	-1.0921E-02	-5.6173E-05	0.0000E+00	-1.0865E-02	0.0000E+00
13	3.3433E-05	0.0000E+00	-7.8877E-03	-1.6716E-05	0.0000E+00	-7.8710E-03	0.0000E+00
14	2.8198E-05	0.0000E+00	-5.6848E-03	-1.4099E-05	0.0000E+00	-5.6707E-03	0.0000E+00
15	4.5747E-05	0.0000E+00	-3.7364E-03	-2.2874E-05	0.0000E+00	-3.7135E-03	0.0000E+00
16	1.1042E-05	0.0000E+00	-2.2786E-03	-5.5208E-06	0.0000E+00	-2.2731E-03	0.0000E+00
17	1.6120E-05	0.0000E+00	-1.0342E-03	-8.0602E-06	0.0000E+00	-1.0261E-03	0.0000E+00
total	2.9921E-02	0.0000E+00	-6.0858E-01	-1.4960E-02	0.0000E+00	-5.9362E-01	0.0000E+00

print table 130

**X** 1photon weight balance in each cell -- variance reduction events

cell	weight window	cell importance	weight cutoff	energy importance	dxtran	forced collision	exponential transform	total
2	0.0000E+00	0.0000E+00	1.6185E-04	0.0000E+00	0.0000E+00	0.0000E+00	0.0000E+00	1.6185E-04
3	0.0000E+00	0.0000E+00	-5.6439E-04	0.0000E+00	0.0000E+00	0.0000E+00	0.0000E+00	-5.6439E-04
4	0.0000E+00	0.0000E+00	-3.1260E-04	0.0000E+00	0.0000E+00	0.0000E+00	0.0000E+00	-3.1260E-04
5	0.0000E+00	0.0000E+00	-8.6533E-04	0.0000E+00	0.0000E+00	0.0000E+00	0.0000E+00	-8.6533E-04
6	0.0000E+00	0.0000E+00	-4.1528E-04	0.0000E+00	0.0000E+00	0.0000E+00	0.0000E+00	-4.1528E-04
7	0.0000E+00	-5.5121E-03	6.4045E-04	0.0000E+00	0.0000E+00	0.0000E+00	0.0000E+00	-4.8716E-03
8	0.0000E+00	0.0000E+00	1.0003E-04	0.0000E+00	0.0000E+00	0.0000E+00	0.0000E+00	1.0003E-04
total	5.5467E+00	0.0000E+00	0.0000E+00	0.0000E+00	-6.0656E+00	0.0000E+00	-5.1898E-01	0.0000E+00

9	0.0000E+00	0.0000E+00	-1.0854E-04	0.0000E+00	0.0000E+00	0.0000E+00	0.0000E+00	0.0000E+00	0.0000E+00	0.0000E+00	0.0000E+00	0.0000E+00	0.0000E+00	0.0000E+00	0.0000E+00	0.0000E+00	0.0000E+00	0.0000E+00	0.0000E+00	0.0000E+00	-1.0854E-04
10	0.0000E+00	-2.5548E-03	1.0642E-05	0.0000E+00	0.0000E+00	0.0000E+00	0.0000E+00	0.0000E+00	0.0000E+00	0.0000E+00	0.0000E+00	0.0000E+00	0.0000E+00	0.0000E+00	0.0000E+00	0.0000E+00	0.0000E+00	0.0000E+00	0.0000E+00	0.0000E+00	-2.5442E-03
11	0.0000E+00	0.0000E+00	-2.3652E-04	0.0000E+00	0.0000E+00	0.0000E+00	0.0000E+00	0.0000E+00	0.0000E+00	0.0000E+00	0.0000E+00	0.0000E+00	0.0000E+00	0.0000E+00	0.0000E+00	0.0000E+00	0.0000E+00	0.0000E+00	0.0000E+00	0.0000E+00	-2.3652E-04
12	0.0000E+00	0.0000E+00	1.6010E-04	0.0000E+00	0.0000E+00	0.0000E+00	0.0000E+00	0.0000E+00	0.0000E+00	0.0000E+00	0.0000E+00	0.0000E+00	0.0000E+00	0.0000E+00	0.0000E+00	0.0000E+00	0.0000E+00	0.0000E+00	0.0000E+00	0.0000E+00	1.6010E-04
13	0.0000E+00	3.7151E-04	3.7336E-04	0.0000E+00	0.0000E+00	0.0000E+00	0.0000E+00	0.0000E+00	0.0000E+00	0.0000E+00	0.0000E+00	0.0000E+00	0.0000E+00	0.0000E+00	0.0000E+00	0.0000E+00	0.0000E+00	0.0000E+00	0.0000E+00	0.0000E+00	7.4487E-04
14	0.0000E+00	0.0000E+00	-7.7834E-05	0.0000E+00	0.0000E+00	0.0000E+00	0.0000E+00	0.0000E+00	0.0000E+00	0.0000E+00	0.0000E+00	0.0000E+00	0.0000E+00	0.0000E+00	0.0000E+00	0.0000E+00	0.0000E+00	0.0000E+00	0.0000E+00	0.0000E+00	-7.7834E-05
15	0.0000E+00	-1.5345E-04	9.8355E-05	0.0000E+00	0.0000E+00	0.0000E+00	0.0000E+00	0.0000E+00	0.0000E+00	0.0000E+00	0.0000E+00	0.0000E+00	0.0000E+00	0.0000E+00	0.0000E+00	0.0000E+00	0.0000E+00	0.0000E+00	0.0000E+00	0.0000E+00	-5.5098E-05
16	0.0000E+00	-4.6109E-05	-2.6627E-05	0.0000E+00	0.0000E+00	0.0000E+00	0.0000E+00	0.0000E+00	0.0000E+00	0.0000E+00	0.0000E+00	0.0000E+00	0.0000E+00	0.0000E+00	0.0000E+00	0.0000E+00	0.0000E+00	0.0000E+00	0.0000E+00	0.0000E+00	-7.2736E-05
17	0.0000E+00	0.0000E+00	-3.6924E-05	0.0000E+00	0.0000E+00	0.0000E+00	0.0000E+00	0.0000E+00	0.0000E+00	0.0000E+00	0.0000E+00	0.0000E+00	0.0000E+00	0.0000E+00	0.0000E+00	0.0000E+00	0.0000E+00	0.0000E+00	0.0000E+00	0.0000E+00	-3.6924E-05

total 0.0000E+00 -7.8949E-03 -1.0993E-03 0.0000E+00 0.0000E+00 0.0000E+00 0.0000E+00 0.0000E+00 0.0000E+00 0.0000E+00 0.0000E+00 0.0000E+00 0.0000E+00 0.0000E+00 0.0000E+00 0.0000E+00 0.0000E+00 0.0000E+00 0.0000E+00 0.0000E+00 0.0000E+00 0.0000E+00  
 X 1photon weight balance in each cell -- physical events  
 print table 130

cell	from neutrons	bremsstrahlung	p-annihilation	electron x-rays	fluorescence	capture	pair production	total
2	4.6576E-01	1.3117E-01	4.3772E-02	0.0000E+00	0.0000E+00	-2.5835E-01	-2.1886E-02	3.6046E-01
3	3.9309E-01	1.6619E-01	4.6183E-02	0.0000E+00	0.0000E+00	-4.0474E-01	-2.3092E-02	1.7764E-01
4	2.7820E-01	1.2576E-01	3.7790E-02	0.0000E+00	0.0000E+00	-3.7475E-01	-1.8895E-02	4.8105E-02
5	2.2175E-01	1.2742E-01	3.6338E-02	0.0000E+00	0.0000E+00	-3.4004E-01	-1.8169E-02	2.7297E-02
6	1.5651E-01	7.8617E-02	2.7130E-02	0.0000E+00	0.0000E+00	-2.6548E-01	-1.3565E-02	-1.6789E-02
7	1.1943E-01	6.9034E-02	1.9332E-02	0.0000E+00	0.0000E+00	-2.0307E-01	-9.6661E-03	-4.9435E-03
8	8.9937E-02	6.1268E-02	1.7977E-02	0.0000E+00	0.0000E+00	-1.7386E-01	-8.9885E-03	-1.3671E-02
9	6.4458E-02	3.9925E-02	1.5964E-02	0.0000E+00	0.0000E+00	-1.2526E-01	-7.9818E-03	-1.2899E-02
10	4.6276E-02	2.8892E-02	8.8699E-03	0.0000E+00	0.0000E+00	-8.5763E-02	-4.4349E-03	-6.1597E-03
11	3.4747E-02	2.1394E-02	6.0028E-03	0.0000E+00	0.0000E+00	-6.5370E-02	-3.0014E-03	-6.2274E-03
12	2.6405E-02	1.6839E-02	4.9917E-03	0.0000E+00	0.0000E+00	-5.1109E-02	-2.4958E-03	-5.3696E-03
13	1.7351E-02	1.3353E-02	3.8170E-03	0.0000E+00	0.0000E+00	-4.0656E-02	-1.9085E-03	-8.0441E-03
14	1.3261E-02	8.8015E-03	3.4989E-03	0.0000E+00	0.0000E+00	-2.7763E-02	-1.7495E-03	-3.9513E-03
15	8.3679E-03	6.1235E-03	1.7251E-03	0.0000E+00	0.0000E+00	-1.9678E-02	-8.6255E-04	-4.3245E-03
16	5.1510E-03	3.9539E-03	1.2204E-03	0.0000E+00	0.0000E+00	-1.1790E-02	-6.1019E-04	-2.0752E-03
17	2.3495E-03	2.5404E-03	7.2662E-04	0.0000E+00	0.0000E+00	-6.3288E-03	-3.6331E-04	-1.0755E-03

total 1.9430E+00 9.0128E-01 2.7534E-01 0.0000E+00 0.0000E+00 -2.4540E+00 -1.3767E-01 5.2798E-01  
 X 1neutron activity of each nuclide in each cell, per source particle  
 print table 140

N47 cell	nuclides	atom fraction	total collisions	* weight	collisions weight lost to capture	weight gain by fission	weight gain by (n,xn)
2	1001.60c	8.4764E-02	10340	5.9405E-01	2.1850E-03	0.0000E+00	0.0000E+00
	8016.60c	6.0409E-01	22198	1.5088E+00	6.1243E-02	0.0000E+00	0.0000E+00
	11023.60c	9.4725E-03	468	3.1718E-02	1.1632E-03	0.0000E+00	0.0000E+00
	12000.60c	2.9983E-03	137	9.0702E-03	4.5896E-04	0.0000E+00	0.0000E+00
	13027.60c	2.4834E-02	783	5.5924E-02	2.6602E-03	0.0000E+00	3.4810E-04
	14000.60c	2.4186E-01	7891	5.6185E-01	5.0501E-02	0.0000E+00	5.5828E-03
	19000.60c	6.8551E-03	273	1.9129E-02	3.3765E-03	0.0000E+00	0.0000E+00
	20000.60c	2.0481E-02	734	5.2808E-02	6.4912E-03	0.0000E+00	6.9295E-05
	26054.60c	2.7432E-04	15	9.5659E-04	9.5529E-05	0.0000E+00	0.0000E+00

# CHAPTER 5

## TEST1 PROBLEM AND OUTPUT

SKIP 182 LINES IN OUTPUT

26056.60c	4.2645E-03	329	2.1357E-02	1.0886E-03	0.0000E+00	3.4627E-04
26057.60c	9.7640E-05	3	2.4055E-04	1.4268E-06	0.0000E+00	0.0000E+00
26058.60c	1.3019E-05	0	0.0000E+00	0.0000E+00	0.0000E+00	0.0000E+00
17	1001.60c	22594	2.8629E-02	2.1287E-04	0.0000E+00	0.0000E+00
17	8016.60c	26465	3.4788E-02	7.6736E-05	0.0000E+00	0.0000E+00
	11023.60c	507	6.7990E-04	3.9230E-05	0.0000E+00	0.0000E+00
	12000.60c	158	2.1435E-04	2.4640E-06	0.0000E+00	0.0000E+00
	13027.60c	543	7.3032E-04	4.3007E-05	0.0000E+00	0.0000E+00
	14000.60c	6684	8.9450E-03	3.4309E-04	0.0000E+00	8.0602E-06
	19000.60c	295	3.8275E-04	1.3559E-04	0.0000E+00	0.0000E+00
	20000.60c	758	9.9921E-04	8.1763E-05	0.0000E+00	0.0000E+00
	26054.60c	14	1.8735E-05	4.4469E-06	0.0000E+00	0.0000E+00
	26056.60c	613	7.7358E-04	9.2645E-05	0.0000E+00	0.0000E+00
	26057.60c	6	7.1280E-06	2.3103E-06	0.0000E+00	0.0000E+00
	26058.60c	0	0.0000E+00	0.0000E+00	0.0000E+00	0.0000E+00
total		1143962	3.1309E+01	6.0858E-01	0.0000E+00	1.4960E-02

N48

total over all cells for each nuclide							
cell	nuclides	atom fraction	total collisions	collisions * weight	weight lost to capture	weight gain by fission	weight gain by (n,xn)
	1001.60c		408622	9.7833E+00	5.5216E-02	0.0000E+00	0.0000E+00
	8016.60c		532245	1.5216E+01	1.9888E-01	0.0000E+00	0.0000E+00
	11023.60c		10922	3.4009E-01	1.2149E-02	0.0000E+00	1.7272E-04
	12000.60c		2698	8.2127E-02	1.6235E-03	0.0000E+00	8.0808E-05
	13027.60c		13111	4.4408E-01	1.9264E-02	0.0000E+00	5.1297E-04
	14000.60c		144029	4.5450E+00	2.2217E-01	0.0000E+00	1.2428E-02
	19000.60c		5627	1.5700E-01	3.6066E-02	0.0000E+00	6.6908E-05
	20000.60c		15525	4.5637E-01	3.8979E-02	0.0000E+00	6.9295E-05
	26054.60c		329	1.0683E-02	1.2161E-03	0.0000E+00	0.0000E+00
	26056.60c		10728	2.6969E-01	2.2624E-02	0.0000E+00	1.5756E-03
	26057.60c		113	3.3625E-03	3.5985E-04	0.0000E+00	5.4288E-05
	26058.60c		13	6.5846E-04	3.8437E-05	0.0000E+00	0.0000E+00

X Iphoton activity of each nuclide in each cell, per source particle

print table 140

cell	nuclides	atom fraction	total collisions	collisions * weight	weight lost to capture	total from neutrons	weight from neutrons	avg photon energy
2	1000.02p	8.4764E-02	15	1.1098E-02	1.8345E-08	2	2.0000E-03	2.2246E+00
	8000.02p	6.0409E-01	1285	8.5473E-01	3.0457E-02	174	1.7400E-01	4.4156E+00
	11000.02p	9.4725E-03	42	2.4661E-02	2.3057E-03	6	6.0000E-03	1.3193E+00
	12000.02p	2.9983E-03	19	1.3428E-02	1.8033E-03	3	3.0000E-03	1.9604E+00
	13000.02p	2.4834E-02	118	7.0548E-02	1.0100E-02	14	1.4000E-02	2.8540E+00
	14000.02p	2.4186E-01	1244	7.2981E-01	1.2357E-01	231	2.3076E-01	2.6378E+00
	19000.02p	6.8551E-03	62	2.9799E-02	9.6794E-03	9	9.0000E-03	2.6985E+00
	20000.02p	2.0481E-02	252	1.2116E-01	4.6341E-02	16	1.6000E-02	2.2538E+00

cell	number of photons	weight per source neut	energy per source neut	collisions * weight	total collisions	collisions	weight lost to capture	total from neutrons	weight from neutrons	avg photon energy
26000.02p	2.7432E-04	10	4.0221E-03	1.0467E-03	1	1.0000E-03				2.0484E+00
26000.02p	4.2645E-03	116	5.0704E-02	3.2799E-02	10	9.9948E-03				3.3209E+00
26000.02p	9.7640E-05	2	2.5624E-04	2.5467E-04	0	0.0000E+00				0.0000E+00
26000.02p	1.3019E-05	0	0.0000E+00	0.0000E+00	0	0.0000E+00				0.0000E+00
SKIP 182 LINES IN OUTPUT										
17	1000.02p	8.4764E-02	3.7967E-04	1.1179E-09	362	2.2625E-04				2.2246E+00
	8000.02p	6.0409E-01	2.2518E-02	8.4831E-04	209	1.4640E-04				4.4367E+00
	11000.02p	9.4725E-03	5.0251E-04	3.2896E-05	229	1.6335E-04				1.9765E+00
	12000.02p	2.9983E-03	1.5427E-04	1.2841E-05	13	1.0031E-05				2.1827E+00
	13000.02p	2.4834E-02	1.5484E-03	2.0988E-04	173	1.2242E-04				3.2435E+00
	14000.02p	2.4186E-01	1.8202E-02	2.9834E-03	1329	9.4460E-04				3.3940E+00
	19000.02p	6.8551E-03	8.1839E-04	2.8755E-04	252	2.8214E-04				3.0306E+00
	20000.02p	2.0481E-02	2.8742E-03	1.1173E-03	296	2.0028E-04				3.11209E+00
	26000.02p	2.7432E-04	5.8109E-05	3.5484E-05	9	1.2335E-05				4.11360E+00
	26000.02p	4.2645E-03	1.2441E-04	7.8711E-04	333	2.3524E-04				3.0109E+00
	26000.02p	9.7640E-05	1.7974E-05	1.2444E-05	3	6.4338E-06				6.2223E-01
	26000.02p	1.3019E-05	1.7165E-06	1.6131E-06	0	0.0000E+00				0.0000E+00
total		170585	1.7674E+01	2.4540E+00	14595	1.9430E+00				3.1865E+00

total over all cells for each nuclide

**N49**

cell	number of photons	weight per source neut	energy per source neut	collisions * weight	total collisions	collisions	weight lost to capture	total from neutrons	weight from neutrons	avg photon energy
1000.02p	1000.02p	1190	1.3776E-01	4.8485E-07	1298	5.8148E-02				2.2246E+00
8000.02p	8000.02p	73520	8.1008E+00	3.0358E-01	1480	5.1081E-01				4.3640E+00
11000.02p	11000.02p	1857	2.1492E-01	1.7868E-02	954	5.8290E-02				1.5248E+00
12000.02p	12000.02p	585	5.6857E-02	5.8439E-03	54	7.4416E-03				2.7424E+00
13000.02p	13000.02p	6033	6.1133E-01	8.6939E-02	752	9.0933E-02				3.2459E+00
14000.02p	14000.02p	65585	6.6356E+00	1.1714E+00	6255	9.5711E-01				2.8011E+00
19000.02p	19000.02p	3490	3.0481E-01	1.0940E-01	1248	8.4874E-02				2.9592E+00
20000.02p	20000.02p	12398	1.1039E+00	4.5537E-01	1199	9.0651E-02				2.7107E+00
26000.02p	26000.02p	5927	5.0785E-01	3.0363E-01	1355	8.4797E-02				2.9565E+00

**N50** Summary of photons produced in neutron collisions

cell	number of photons	weight per source neut	energy per source neut	avg photon energy	mev/gm per source neut	weight/neut collision	energy/neut collision
1	1	0.0000E+00	0.0000E+00	0.0000E+00	0.0000E+00	0.0000E+00	0.0000E+00
2	2	4.65757E-01	1.53080E+00	3.28668E+00	6.15865E-06	1.63086E-01	5.36011E-01
3	3	3.93094E-01	1.22727E+00	3.12206E+00	4.93750E-06	1.01845E-01	3.17965E-01
4	4	2.78202E-01	8.53895E-01	3.06934E+00	3.45337E-06	6.64563E-02	2.03977E-01
5	5	2.21749E-01	7.08568E-01	3.19536E+00	2.85069E-06	5.40855E-02	1.72823E-01
6	6	1.56515E-01	4.62941E-01	2.95781E+00	1.86249E-06	4.29571E-02	1.27059E-01
7	7	1.19427E-01	4.20886E-01	3.52423E+00	1.69330E-06	3.86872E-02	1.36342E-01
8	8	8.99374E-02	2.93122E-01	3.25918E+00	1.17928E-06	3.61670E-02	1.17875E-01
9	9	6.44581E-02	2.00949E-01	3.11751E+00	8.08451E-07	3.30002E-02	1.02878E-01
10	10	4.62759E-02	1.45762E-01	3.14986E+00	5.86427E-07	3.03195E-02	9.55022E-02

# CHAPTER 5

## TEST1 PROBLEM AND OUTPUT

11	11	818	3.47471E-02	1.13936E-01	3.27900E+00	4.58383E-07	2.97751E-02	9.76326E-02
12	12	755	2.64048E-02	8.84458E-02	3.34961E+00	3.55833E-07	3.05754E-02	1.02416E-01
13	13	694	1.73507E-02	5.18621E-02	2.98905E+00	2.08650E-07	2.80586E-02	8.38685E-02
14	14	1510	1.32609E-02	4.28907E-02	3.23436E+00	1.72556E-07	3.06414E-02	9.91053E-02
15	15	1619	8.36792E-03	2.64074E-02	3.15579E+00	1.06241E-07	2.97350E-02	9.38374E-02
16	16	2580	5.15099E-03	1.64214E-02	3.18801E+00	6.60661E-08	3.01936E-02	9.62574E-02
17	17	3208	2.34947E-03	7.34408E-03	3.12584E+00	2.95465E-08	3.08457E-02	9.64187E-02
	total	14595	1.94305E+00	6.19149E+00	3.18649E+00			

energy interval	number of photons	number frequency	cum number distribution	weight of photons	weight frequency	cum weight distribution
20.000	0	0.00000E+00	0.00000E+00	0.00000E+00	0.00000E+00	0.00000E+00
15.000	0	0.00000E+00	0.00000E+00	0.00000E+00	0.00000E+00	0.00000E+00
10.000	22	1.50737E-03	1.50737E-03	6.13839E-03	3.15916E-03	3.15916E-03
9.000	40	2.74066E-03	4.24803E-03	5.44764E-03	2.80366E-03	5.96282E-03
8.000	93	6.37205E-03	1.06201E-02	1.89398E-02	9.74749E-03	1.57103E-02
7.000	758	5.19356E-02	6.25557E-02	9.52411E-02	4.90163E-02	6.47266E-02
6.000	1265	8.66735E-02	1.49229E-01	2.56124E-01	1.31816E-01	1.96543E-01
5.000	475	3.25454E-02	1.81775E-01	5.94310E-02	3.05865E-02	2.27129E-01
4.000	1752	1.20041E-01	3.01816E-01	1.48707E-01	7.65330E-02	3.03662E-01
3.000	2345	1.60671E-01	4.62487E-01	2.67643E-01	1.37744E-01	4.41406E-01
2.000	3014	2.06509E-01	6.68996E-01	3.02696E-01	1.55784E-01	5.97190E-01
1.000	2646	1.81295E-01	8.50291E-01	4.24335E-01	2.18387E-01	8.15577E-01
0.500	903	6.18705E-02	9.12162E-01	1.55504E-01	8.00312E-02	8.95608E-01
0.100	631	4.32340E-02	9.55396E-01	1.22427E-01	6.30077E-02	9.58616E-01
0.010	571	3.91230E-02	9.94519E-01	7.22862E-02	3.72025E-02	9.95818E-01
0.000	80	5.48133E-03	1.00000E+00	8.12513E-03	4.18165E-03	1.00000E+00
total	14595	1.00000E+00		1.94305E+00		1.00000E+00

**NS1** tally 11 nps = 10000  
 tally type 1 number of particles crossing a surface.  
 tally for neutrons

surface	energy	18
1.0000E-04	4.73427E-03	0.0428
1.0000E-03	3.41844E-04	0.0949
1.0000E-02	2.66169E-04	0.1057
5.0000E-02	2.08038E-04	0.1153
1.0000E-01	1.43064E-04	0.1545
5.0000E-01	3.19056E-04	0.1002
1.0000E+00	2.80542E-04	0.0978
2.0000E+00	4.25783E-04	0.0941
3.0000E+00	4.56545E-04	0.0992
4.0000E+00	1.52545E-04	0.1326
5.0000E+00	1.50381E-04	0.1501

```

6.0000E+00  7.57808E-05  0.2022
7.0000E+00  9.91571E-05  0.1866
8.0000E+00  4.22977E-05  0.2764
9.0000E+00  3.08416E-05  0.3153
1.0000E+01  2.63550E-05  0.3440
1.1000E+01  4.98461E-05  0.2830
1.2000E+01  1.77223E-05  0.3324
1.3000E+01  3.75968E-05  0.2468
1.4000E+01  1.67052E-04  0.1568
1.5000E+01  9.08942E-05  0.3073
total      8.11579E-03  0.0393

```

lanalysis of the results in the tally fluctuation chart bin (tfc) for tally 11 with nps = 10000 print table 160

**N52**normed average tally per history = 8.11579E-03 **N53**unnormed average tally per history = 8.11579E-03  
 estimated tally relative error = 0.0393 **N54**estimated variance of the variance = 0.0050  
**N55**relative error from zero tallies = 0.0278 **N56**relative error from nonzero scores = 0.0278  
 number of nonzero history tallies = 1143 **N57**efficiency for the nonzero tallies = 0.1143  
 history number of largest tally = 9766 **N58**largest unnormalized history tally = 5.04052E-01  
 (largest tally)/(average tally) = 6.21076E+01 (largest tally)/(avg nonzero tally)= 7.09889E+00  
**N59**(confidence interval shift)/mean = 0.0012 shifted confidence interval center = 8.12539E-03  
**N60**if the largest history score sampled so far were to occur on the next history, the tfc bin quantities would change as follows:

estimated quantities	value at nps	value at nps+1	value(nps+1)/value(nps)-1.
mean	8.11579E-03	8.16537E-03	0.006110
relative error	3.93120E-02	3.95385E-02	0.005761
variance of the variance	4.95966E-03	5.27658E-03	0.063899
shifted center	8.12539E-03	8.12574E-03	0.000043
figure of merit	1.96707E+02	1.94460E+02	-0.011424

**N61**the estimated slope of the 57 largest tallies starting at 1.99571E-01 appears to be decreasing at least exponentially. the large score tail of the empirical history score probability density function appears to have no unsampled regions.

```

=====
N62 results of 10 statistical checks for the estimated answer for the tally fluctuation chart (tfc) bin of tally 11
tfc bin --mean-- -----relative error----- ----variance of the variance---- --figure of merit-- -pdf-
behavior behavior value decrease decrease rate value decrease decrease rate value behavior slope
desired random <0.10 yes 1/sqrt(nps) <0.10 yes 1/nps constant random >3.00
observed random 0.04 yes yes 0.00 yes yes constant random 10.00
passed? yes yes yes yes yes yes yes yes
N63 N64 N65 N66 N67 N68 N69 N70 N71 N72
=====

```

**N73**this tally meets the statistical criteria used to form confidence intervals: check the tally fluctuation chart to verify.







# CHAPTER 5

## TEST1 PROBLEM AND OUTPUT

26 missed 1 of 10 tfc bin checks: the slope of decrease of largest tallies is less than the minimum acceptable value of 3.0  
missed all bin error check: 22 tally bins had 5 bins with zeros and 8 bins with relative errors exceeding 0.10

6 passed the 10 statistical checks for the tally fluctuation chart bin result  
missed all bin error check: 23 tally bins had 0 bins with zeros and 10 bins with relative errors exceeding 0.10

the 10 statistical checks are only for the tally fluctuation chart bin and do not apply to other tally bins.

the tally bins with zeros may or may not be correct: compare the source, cutoffs, multipliers, et cetera with the tally bins.

warning. 3 of the 7 tally fluctuation chart bins did not pass all 10 statistical checks.  
warning. 6 of the 7 tallies had bins with relative errors greater than recommended.

**N77**tally fluctuation charts

nps	tally 11				tally 16				tally 34						
	mean	error	vov	slope	fom	mean	error	vov	slope	fom	mean	error	vov	slope	fom
1000	7.2180E-03	0.1255	0.0365	0.0	197	7.2179E-09	0.2134	0.0889	0.0	68	1.6244E-08	0.2134	0.0889	0.0	68
2000	6.8028E-03	0.0929	0.0303	0.0	179	6.9752E-09	0.1661	0.0630	0.0	56	1.5698E-08	0.1661	0.0630	0.0	56
3000	7.4265E-03	0.0742	0.0174	0.0	189	8.2071E-09	0.1351	0.0471	0.0	57	1.8470E-08	0.1351	0.0471	0.0	57
4000	7.0511E-03	0.0655	0.0143	0.0	183	7.5738E-09	0.1168	0.0383	0.0	58	1.7045E-08	0.1168	0.0383	0.0	58
5000	7.4809E-03	0.0575	0.0107	10.0	188	8.5002E-09	0.1012	0.0359	10.0	61	1.9130E-08	0.1012	0.0359	10.0	61
6000	7.7297E-03	0.0515	0.0084	10.0	194	9.7427E-09	0.0901	0.0248	10.0	63	2.1926E-08	0.0901	0.0248	10.0	63
7000	7.9401E-03	0.0473	0.0070	10.0	196	9.9476E-09	0.0848	0.0267	10.0	61	2.2387E-08	0.0848	0.0267	10.0	61
8000	8.0837E-03	0.0436	0.0058	10.0	201	1.0507E-08	0.0783	0.0218	10.0	62	2.3646E-08	0.0783	0.0218	10.0	62
9000	8.1393E-03	0.0413	0.0052	10.0	198	1.0646E-08	0.0738	0.0185	10.0	62	2.3960E-08	0.0738	0.0185	10.0	62
10000	8.1158E-03	0.0393	0.0050	10.0	197	1.0908E-08	0.0702	0.0170	10.0	62	2.4549E-08	0.0702	0.0170	10.0	62

nps	tally 1				tally 12				tally 26						
	mean	error	vov	slope	fom	mean	error	vov	slope	fom	mean	error	vov	slope	fom
1000	1.1542E-02	0.1630	0.1624	0.0	117	1.0229E-06	0.1433	0.0886	0.0	151	5.4916E-08	0.1475	0.1010	0.0	143
2000	1.1783E-02	0.1181	0.0755	0.0	111	1.0670E-06	0.1111	0.0740	0.0	125	5.7742E-08	0.1073	0.0392	0.0	134
3000	1.0625E-02	0.0942	0.0573	0.0	117	9.7872E-07	0.0886	0.0527	0.0	132	5.2554E-08	0.0861	0.0286	0.0	140
4000	1.0378E-02	0.0798	0.0404	0.0	123	9.5219E-07	0.0760	0.0364	0.0	136	5.0781E-08	0.0747	0.0210	0.0	141
5000	1.1485E-02	0.0714	0.0283	4.7	122	1.0385E-06	0.0680	0.0252	3.4	134	5.6158E-08	0.0706	0.0473	3.6	125
6000	1.1698E-02	0.0642	0.0228	5.0	125	1.0537E-06	0.0610	0.0200	3.8	138	5.7865E-08	0.0647	0.0375	3.3	123
7000	1.1569E-02	0.0603	0.0198	10.0	121	1.0470E-06	0.0572	0.0173	3.6	134	5.6676E-08	0.0598	0.0312	3.5	123
8000	1.1624E-02	0.0552	0.0166	8.9	125	1.0481E-06	0.0526	0.0147	5.8	138	5.7311E-08	0.0545	0.0256	2.9	128
9000	1.2111E-02	0.0536	0.0195	4.8	117	1.0966E-06	0.0509	0.0163	4.2	130	5.9588E-08	0.0523	0.0219	2.9	123
10000	1.1784E-02	0.0509	0.0179	4.0	117	1.0654E-06	0.0483	0.0150	5.3	130	5.8153E-08	0.0495	0.0199	2.9	124

nps	tally 6			
	mean	error	vov	slope
1000	6.2134E-08	0.1377	0.0837	0.0
2000	6.4718E-08	0.1017	0.0349	0.0
3000	6.0761E-08	0.0812	0.0236	0.0

4000	5.8355E-08	0.0707	0.0179	10.0	157
5000	6.4658E-08	0.0656	0.0372	4.7	144
6000	6.7607E-08	0.0599	0.0289	4.0	144
7000	6.6623E-08	0.0552	0.0239	4.0	144
8000	6.7818E-08	0.0504	0.0192	4.1	150
9000	7.0235E-08	0.0482	0.0166	4.2	145
10000	6.9061E-08	0.0458	0.0147	4.2	145

**N78**neutron weight-window lower bounds from the weight-window generator

print table 190

```
energy: 1.000E+02
cell
1 -1.000E+00
2 5.000E-01
3 3.886E-01
4 3.065E-01
5 2.441E-01
6 1.960E-01
7 1.576E-01
8 1.274E-01
9 9.844E-02
10 7.579E-02
11 5.991E-02
12 4.737E-02
13 3.811E-02
14 3.181E-02
15 2.758E-02
16 2.483E-02
17 2.831E-02
lphoton weight-window lower bounds from the weight-window generator
```

print table 190

```
energy: 1.000E+02
cell
1 -1.000E+00
2 1.155E+02
3 3.156E+01
4 1.538E+01
5 6.782E+00
6 4.129E+00
7 2.122E+00
8 1.243E+00
9 7.722E-01
10 4.657E-01
11 2.671E-01
12 1.528E-01
13 9.071E-02
14 5.465E-02
15 3.162E-02
16 1.733E-02
17 9.827E-03
```

**CHAPTER 5  
TEST1 PROBLEM AND OUTPUT**

print table 200

**N79** weight-window cards from the weight-window generator

each card has ten leading blanks that must be removed by a text editor.

```

wpp:n 5 3 5 0 0 0
wwe:n 1.0000E+02
wnn 1:n -1.0000E+00 5.0000E-01 3.8863E-01 3.0648E-01 2.4414E-01
1.9598E-01 1.5757E-01 1.2742E-01 9.8439E-02 7.5788E-02
5.9910E-02 4.7368E-02 3.8112E-02 3.1809E-02 2.7585E-02
2.4827E-02 2.8306E-02
wpp:p 5 3 5 0 0 0
wwe:p 1.0000E+02
wnn 1:p -1.0000E+00 1.1548E+02 3.1561E+01 1.5376E+01 6.7818E+00
4.1291E+00 2.1218E+00 1.2429E+00 7.7217E-01 4.6575E-01
2.6710E-01 1.5285E-01 9.0710E-02 5.4652E-02 3.1623E-02
1.7327E-02 9.8268E-03

```

\*\*\*\*\*  
**N80**dump no. 2 on file test1.r nps = 10000 coll = 1314547 ctm = 3.29 nrn = 20699414  
\*\*\*\*\*

8 warning messages so far.

**N80**run terminated when 10000 particle histories were done.

computer time = 3.42 minutes  
mcnp version 4c 01/20/00

06/23/00 11:34:30 probid = 06/23/00 11:30:40

**Notes:**

- N1: The first line of the output file identifies the code name and version. LD=xx identifies the code version date. The last two entries are the date and time the run was made.
- N2: This is an echo of the execution line.
- N3: The numbers in this first column are sequential line numbers for the input file. They may be useful if you make changes to the file with an editor.
- N4: Defines a source at the point 0,0,0 on surface 2. The particles will enter cell 2. The entry CEL=2 is not needed, but if you choose to use it and type in the wrong cell number, the code will give you an error message. The weight of each source particle is 1, the default. VEC and DIR determine the starting direction. In this problem, the source is monodirectional in the y direction. All source particles have a starting energy of 14.19 MeV.
- N5: The PWT card controls the number and weight of neutron-induced photons produced at neutron collisions.
- N6: Energy bins for all tallies but F6 and F12. 13I means put 13 interpolates between 1 and 15 MeV. These energy bins are printed in PRINT TABLE 30.

–Table 10–

- N7: All source variables defined explicitly or by default are printed. The order of sampling of the source variables is also printed, which is important for sources that are dependent upon functions.

–Table 30–

- N8: This entry identifies which particle type and tally type is used (neutron, photon, or electron).
- N9: This warning is generated because the upper limit of the E0 card of 20 MeV is higher than the maximum energy specified on the PHYS:N card.
- N10: The energy bins are specified by the E0, E6, and E12 cards. Tallies F1, F11, F16, F26, and F34 have energy bins specified by the E0 card. F6 and F12 have energy bins specified by the E6 and E12 cards.

**CHAPTER 5**  
**TEST1 PROBLEM AND OUTPUT**

–Table 50–

N11: A cell can be composed of physically separate regions or pieces joined with the union operator. Improperly defined cells can be composed unintentionally of more than one piece (for example, a surface is extended unknowingly and forms a cell). If a cell is composed of more than one piece, a warning message is given and you should verify that the number of pieces is correct or incorrect.

–Table 60–

N12: If you know the mass or volume of a geometry or parts of it, you can compare the known volume or mass with what MCNP calculates to verify the correctness of your geometry. Be careful, however, that volumes or masses that MCNP cannot calculate (but supplies a value such as unity) do not affect the totals.

–Table 70–

N13: These entries are the surface coefficients used by the code and are not necessarily the entries on the surface cards.

–Table 72–

N14: This is the temperature calculated by MCNP for cells 2–17. Because there was not a TMPn:N card in the input file, room temperature (2.53E–08 MeV) is assumed. Cell 1 has zero importance and is therefore not affected. The minimum and maximum source weights are also printed here because they are sometimes dependent upon cell volumes and cannot be printed earlier. When the source is biased in any way, there will be a fluctuation in starting source weights. The minimum source weight is used in the weight cutoff game when negative weight cutoffs are entered on the CUT cards. By playing the weight cutoff game relative to the minimum source weight, the weight cutoff in each cell is the same regardless of starting source wight. Note that if the source weight can go to zero, the miniumum source weight is set to 1.E–10 times the value of the WGT parameter on the SDEF card.

–Table 98–

N15: The physical constants used in MCNP and changeable in parameter statements in COMMON blocks are listed here. The compilation options are also listed. Knowing how the code was compiled is very useful if it runs slowly (pointer option), runs out of space (pointer option not used), doesn't plot (plot option wrong for your machine or run-time libraries for plotting located differently on your machine), or can't find the data libraries (wrong datapath–so you must use “setenv DATAPATH ...” on Unix systems).

–Table 100–

- N16: The cross-section table list shows the nuclear data used in the problem. The C appended to the neutron data indicates continuous energy. A D would indicate discrete reactions. A P indicates photon data, and an E indicates electron data. Note that photon and electron data are all elemental (1000.02P) rather than isotopic (1001.60C). Warnings are printed in MODE N P problems if the photon production cross sections are unavailable or are in the less accurate equiprobable bin format. Note that electron data are loaded even though electrons are not transported in this MODE N P problem. The electron data are used for the thick target Bremsstrahlung model.
- N17: If a neutron is born at an energy greater than  $E_{max}$  as set by the PHYS:N card, that neutron is rejected and the event (such as fission) is resampled until an energy below  $E_{max}$  is obtained.
- N18: Any neutron cross sections outside the energy range of the problem as specified by the PHYS:N and CUT:N cards are deleted.
- N19: The ‘Density Effect Data’ Table contains the material data necessary to correct the stopping power term for the polarization of the media. If a fast electron passes through an equal linear density of two materials it will lose more energy in a sparse material than in a dense material. This effect is very small for heavier particles but for electrons with relativistic velocities transversing dielectrics media it can be significant. For 1 MeV electrons in water this correction can be as large as 5%.
- N20: This is the electron range and straggling table for material 1 (Los Alamos concrete). It lists 133 electron energies in ascending order (only some are shown in this listing) and gives the respective stopping powers due to collision and radiation and the range of the electron in the material. Radiation yield is the fraction of the electron's kinetic energy which is converted into bremsstrahlung energy. The electron physics is turned on in this MODE N P problem for the thick target bremsstrahlung model.
- N21: The table entitled “Secondary electron production for material 1” contains a list of 133 electron energies in ascending order (only some are shown in this listing) and gives the respective stopping powers due to collision and radiation and the range of the secondary electron created in the electron in the material.
- N22: At the end of the cross section processing, and before histories are started, the first dump is made to the RUNTPE file. This dump contains all the fixed information about the problem, namely the problem specification and all nuclear data. Subsequent dumps to RUNTPE will contain only information that accumulates as histories are run, such as tally information and particle statistics for summary and ledger tables.

## CHAPTER 5

### TEST1 PROBLEM AND OUTPUT

–Table 110–

N23: This table gives starting information about the first 50 source particles. X, Y, and Z tells the initial position. CELL identifies what cell the particle started in or was directed into. SURF identifies what surface the particle started on, if any. U, V, and W identifies the starting direction cosines. The starting time, weight and energy of the particles are also given.

–Problem Summary–

- N24: This is the summary page of the problem. It is a balance sheet with the left side showing how particle tracks, weight, and energy were created and right side showing how they were lost. The problem summary is for accounting only, because most entries, such as “tracks,” have no physical meaning and trying to give physical interpretation to these numerical quantities may be dangerous. The weight and energy columns contain the physical results. Because the summary contains net creation and loss, physical interpretation must be done with care.
- N25: 35681 represents the increased number of tracks obtained and banked from cell splitting, which occurs when the ratio of importances of the cell entered to the cell exited is greater than one. If the ratio is less than one, Russian roulette is played. If the track survives the roulette, its increase in weight and energy are recorded as a gain. If it loses, it is recorded as a loss in all three categories on the loss side of the table.
- N26: The creation from weight cutoff represents the weight and energy gained from winning the weight cutoff Russian roulette game. No tracks are created because the original track continues with an increased weight.
- N27: Any tracks that enter a cell of zero importance are considered to have escaped the geometry and are recorded here. This is the physical leakage from the system. The precision of this result is unknown because no relative error is calculated as is with a tally.
- N28: Loss to importance sampling results from losing the Russian roulette game played when crossing a surface into a cell of lower importance. The weight and energy losses should agree with gains in N25 with perfect sampling.
- N29: Loss to weight cutoff comes from losing the weight cutoff Russian roulette game. With perfect sampling, the weight and energy lost here should equal the weight and energy gained in N26. What is accumulated in the three loss entries is the number, weight, and weight times energy of the tracks lost to weight cutoff. The weight entry in the table is normalized by the number of source particles and the energy entry by the total weight of

- source particles. Thus the average weight of each track lost to the weight cutoff is: weight entry \* NPS/number of tracks lost:  $0.080533 * 10000 / 8625 = 0.09337$ . The small average track weight is caused by the scaling of the weight cutoff criteria by the ratio of the source cell importance to the collision cell importance. The average energy of a particle lost to weight cutoff per source particle is: energy entry/weight entry \* average source starting weight:  $(0.055477/0.080533) * 1.0 = 0.68889$ . The same normalizing procedure applies to all energy entries in both the creation and loss columns of this table.
- N30: In a scattering event only energy is changed. Energy difference = energy in – energy out. If this difference is positive, it is entered as downscattering on the loss side; if negative, as in a thermal neutron upscatter, it is entered on the creation side as upscattering. Thermal neutron scatter always results in a small energy gain or loss. (Elastic collisions in the center-of-mass system gain or lose energy in the laboratory system.) Higher energy scatter usually is an energy loss mechanism. This energy is only for the track being followed. If the collision is a fission or (x,xn), the tracks in addition to one outgoing track are recorded in the three creation columns of the fission and (x,xn) rows.
- N31: Tracks are lost to capture only if the analog capture option is used (PHYS or CUT card). In this problem, implicit capture was used to remove a fraction of each particle's weight at each collision. The energy lost is the incident energy of the particle times the weight lost to capture. The weight lost to absorption (n,0n) is a physically meaningful quantity. No relative error is calculated.
- N32: Note that the total gain and the total loss of the track quantities balance exactly in all problems.
- N33: Whereas all neutrons in this problem started at time zero, the average time of escape is also the prompt neutron escape lifespan and the average time of capture is also the prompt capture (n,0n) lifespan. As there is no fission in the problem, escape and capture are the only two physical removal mechanisms; thus the average time to capture or escape is both the prompt removal lifespan and the prompt removal lifetime. See Chapter 2, page 2-164. These quantities are absorption estimates averaged over all histories; track length estimates can be calculated with the FM card. The “average time of” is always measured relative to time zero and is mostly of use in setting a time cutoff, time bins, or getting a better feel for what is happening in the problem.
- N34: The second entry of the net multiplication is the relative error or the multiplication corresponding to one standard deviation. In this problem, the net multiplication, which is the sum of the source weight and the weight from (x,xn) reactions, is 1.0150 +/- %. The net multiplication is not the criticality eigenvalue  $k_{eff}$  of the system. See page 2-176 for further discussion of this subject.



## CHAPTER 5

### TEST1 PROBLEM AND OUTPUT

N35: Pair production caused the loss of 999 tracks with a weight of 0.13767. The electron from pair production is assumed to immediately annihilate and lose all its energy in the cell, unless it is followed in MODE P E. The positron is annihilated (p-annihilation), producing two photons (1998 tracks with weight 0.27534), each with energy 0.511 MeV isotropic in direction.

N36: For a MODE N P problem, the “average time of” for a photon is relative to zero time, and not the time when the photon was produced. Thus the “average time of” escape or capture includes the mean time to creation.

–Table 126–

N37: Tracks entering a cell refers to all tracks entering a cell, including source particles. If a track leaves a cell and later reenters that same cell, it is counted again. Does not include particles from the bank (from variance reduction events at collisions or physical events at collisions.)

N38: Population in a cell is the number of tracks entering a cell plus source particles plus particles from the bank (from variance reduction or physical events at collisions.) Population does not include reentrant tracks. Comparing N37 to N38 will indicate the amount of back scattering in the problem. An often successful rule of thumb for choosing importances is to select them so that population is kept roughly constant in all cells between the source and tally regions. Information, once lost, cannot be regained. The 13029 particles in cell 8 can contain no more information than the 7005 particles in cell 6 because all particles in cell 8 are progeny of the particles in cell 6. Oversplitting or undersplitting has occurred between cell 6 and cell 8.

N39: The number of collisions in a cell is important for a detector tally or anything involving collision rate. A lack of collisions may indicate a need to force them. This quantity is not normalized by cell volume. In some problems most of the computer time is spent modeling collisions. Cells with excessive numbers of collisions are possibly oversampled. This often happens when many thermal neutrons rattle around and contribute little of significance to the problem solution. In such cases energy-dependent weight windows are most effective, followed by energy roulette, exponential transform, time cutoff, or energy cutoff. Note that the last two methods may introduce a bias into the problem. Subdividing the cell into smaller cells with different importances also is effective.

N40: The collision times the weight of the particles having the collisions is an indication of how important the collisions were.

N41: The next four items are determined from the distance D to the next collision or surface. The time DT to traverse this distance is determined from  $DT=D/VEL$  where VEL is the

speed of the particle. Furthermore, the flux  $\Phi$  is equal to the number density  $n(E)$  times the speed.

The energy ERG averaged over the number density of particles is determined by

$$\frac{\int \int n(E, t) \cdot E dE dt}{\int \int n(E, t) dE dt} \quad \text{or} \quad \frac{\sum (WGT * DT * ERG)}{\sum (WGT * D)}$$

N42: The energy averaged over the flux density is

$$\frac{\int \int \Phi(E, t) \cdot E dE dt}{\int \int \Phi(E, t) dE dt} \quad \text{or} \quad \frac{\sum (WGT * D * ERG)}{\sum (WGT * D)}$$

It is very difficult, and perhaps meaningless, to determine an average energy because a large spectrum involving several orders of magnitude is frequently involved leading to the problem of representing this by one number. That is why it has been calculated by the two methods of items N41 and N42. If the number-averaged energy is significantly lower than the flux-averaged energy (as is true in this problem), it indicates a large number of low-energy particles. As the energy cutoff in this problem is raised, these two average energies come into closer agreement.

N43: The relative average track weight is  $I_c \Sigma(WGT * D) / (I_s \Sigma D)$ , where  $I_c$  and  $I_s$  are the importances of the cell and the source cell. By making the average track weight relative to the cell importance, the weight reduction from importance splitting is removed. For most problems with proper cell importances, the average track weight is constant from cell to cell and deviations indicate a poor importance function. The variation in average track weight for the photons in the following table suggests that the photon importances (same as neutrons) are poor. With weight windows, the average track weight should be within the weight window bounds.

N44: The average track mean free path is

$$\frac{\int \Phi(E) / \Sigma_t(E) dE}{\int \Phi(E) dE} = \frac{\sum WGT * D / TOTM}{\sum WGT * D},$$

where  $TOTM = \Sigma_t(E)$  is the total macroscopic cross section. The mean free path is strongly dependent upon energy and so this average mean free path may be meaningless. A rule of thumb for guessing at importances is that they should double approximately

## CHAPTER 5

### TEST1 PROBLEM AND OUTPUT

every mean free path. This is usually a very poor rule, but it is sometimes better than nothing. The average track mean free path is thus useful for making poor guesses at cell importances. It is also useful for determining the fictitious radius of point detectors, the outer radius of DXTRAN spheres, exponential transform stretching parameters, the necessity of forced collisions, etc. Occasionally this quantity may even provide physical insight into your problem.

N45: For photons, the number-weighted energy and flux-weighted energy are equal because a photon has a constant velocity regardless of energy. See N37 — N44.

–Table 130–

N46: The next six tables (three for neutrons and three for photons) show all possible ways a particle's weight may be changed in each cell. In addition to telling you what is happening to the particle and where, this information can be useful in debugging a problem. The totals agree with the problem summary.

Note that the neutron weight entering cell 17 is 0.018644, whereas in Table 126 the average relative track weight in cell 17 is 0.41987. This apparent discrepancy is resolved by realizing that the average weight in Table 126 is for a track, while it is for a history in Table 130. Furthermore, in Table 126 the weight is relative, whereas it is absolute here in Table 130. If the average track weight is multiplied by the tracks entering cell 17 (13964) and then divided by both the number of source particles (10,000) and the importance ratio (32), the two weights are in close agreement. Most of the totals over the cells can be compared directly with the weight gain, loss or difference in the Problem Summary. The average value of  $\bar{v}$  in a problem with fissionable material can be obtained by taking the ratio of fission neutrons to fission loss in the neutron physical events table.

–Table 140–

N47: The activity of each nuclide per cell can tell you how important various nuclides, such as trace elements, are to the problem and may aid in selecting cross-section libraries when memory is limited. This chapter only shows a partial listing of this table.

N48: This table is the activity summed over all cells in the problem.

N49: This column shows the total number of photons produced by each isotope in the problem. The earlier entries in this column show photon production per isotope in each cell.

N50: This table is printed only for MODE N P or MODE N P E. It gives you an idea of how many photons were produced in each cell and the energy spectrum of the photons averaged over the problem. Because photons are produced only at neutron collisions,

there is a correlation between the number of collisions in a cell, the PWT card, and this table. The previous table showing the photon activity for the problem includes isotope-dependent neutron-induced photon production information.

### TALLY AND TALLY FLUCTUATION CHARTS

- N51: All tallies here are caused by the F1, F11, F12, F6, F16, F26, and F34 cards in the input file. Only the F11 results are shown. The F11 tally gives the neutron current summed in both directions integrated over a surface. This tally says that between 13 and 14 MeV, the current is  $1.67052E-04 \pm 15.68\%$  within one standard deviation.
- N52: The normed average tally per history describes the average tally normalized over the tally surface or volume. It includes energy- and time-dependent multipliers and some constant multipliers, but excludes most constant multipliers. This is always equal to the total tally.
- N53: The unnormed average tally per history does not always include all multipliers. It is the tally used for statistical analysis and is for the same TFC bin as the normed tally.
- N54: This is the variance of the variance which checks the tally for any effects of inadequately sampled problems. It can pick up tally errors due to insufficient sampling of high weight scores which can cause an underestimated mean and RE. The typical acceptable VOV is 0.1 or less in order to provide a reliable confidence interval.
- N55: This is the relative error component from histories which do not contribute to the tally (zero history scores).
- N56: This is the relative error from only the non zero history scores.
- N57: This is the fraction of total NPS that resulted in nonzero score tallies.
- N58: If there was a great difference between the largest and average tally, the large weight particles would represent important phenomena that have been undersampled and/or poor variance reduction technique selection. To understand what causes the large weight particles, the history number of the largest is printed so that this history can be rerun to get its event log. When the undersampled event is identified, the variance reduction should be modified and the problem rerun. Improved variance reduction usually causes fewer source histories to be run per minute because more time is spent sampling the formerly undersampled important phenomena outside the source. The final result will be an improved (higher) FOM and a lower largest/average tally ratio. As the largest/average tally ratio approaches unity, the problem approaches an ideal zero variance solution. In practice, performing the steps discussed above is an art usually beyond all but the most experienced users and is often difficult, time-consuming, frustrating, and sometimes

## CHAPTER 5

### TEST1 PROBLEM AND OUTPUT

unsuccessful. An alternative is to let MCNP determine the better importance function for the next run with the weight window generator, as has been done in this problem. Use of the generated weight windows printed in PRINT TABLE 190 caused a factor of three improvement in problem efficiency when the problem was rerun.

- N59: This ratio expresses the confidence interval shift as a fraction of the mean. The confidence interval is shifted in the case of an asymmetric probability density function.
- N60: This table provides the user with the information on how the TFC bins would be effected by a high magnitude score occurring on the next history. This can reveal the impact of an infrequent high weight score distorting the TFC bin quantities. The three columns show the value at the current NPS, the value at the next NPS (which is the value of the highest past score), and the ratio of the highest value over the previous lower value.
- N61: These two lines summarize briefly the behavior of the tail of the probability density function. MCNP checks the slope of the high score tail in order to discern whether the problem has been sampled well. If the tail of the probability density function is not decreasing at a fast enough rate, then MCNP will flag this as an insufficiently sampled problem.
- N62: This is the TFC statistical check table which provides the results of ten checks that are used to test the tally for reliability. MCNP checks the behavior of the mean, relative error, variance of the variance, figure of merit and the probability density function. The table presents the desired, observed and actual results along with the pass/no pass message for each test.
- N63: This column shows the desired, observed, and actual behavior of the mean. Random behavior of the mean is desired because an ideal random quantity should exhibit a normal distribution of values around an average value. MCNP checks for non-monotonic (no increasing or decreasing trend) behavior of the mean for the last half of the problem. If the behavior of the mean meets this criteria, then it passes this test. The tally was random over the last half of the problem so it passed this check.
- N64: This column checks if the relative error is below the limit required to provide a reliable confidence interval.
- N65: This column checks if the relative error is decreasing over the length of the problem.
- N66: This column checks for the decrease rate of the relative error as a function of the number of histories(NPS). If the relative error is decreasing at the desired rate for the last half of the problem, then it passes this check.

- N67: This column checks if the variance of the variance (VOV) is below the prescribed value of 0.1.
- N68: This column checks for a monotonically decreasing VOV for the last half of the problem.
- N69: This column is the check for the rate of decrease of the VOV for the last half of the problem.
- N70: This column checks for a statistically constant value of the figure of merit (FOM) for the last half of the problem.
- N71: This column checks the FOM for random behavior.
- N72: This column checks the probability density function (PDF) for the slope of the 25 to 200 largest history scores. If the slope is greater than 3 then the second moment of the PDF exists and the central limit theorem is satisfied. Basically, this means that as the slope increases, a more reliable confidence interval is formed because the problem is sampled more.
- N73: All of the statistical checks were passed, therefore a range of confidence intervals for the unshifted asymmetric distribution is provided. Three ranges are given for the confidence intervals of 1, 2, and 3 standard deviations. The second line displays the ranges for the shifted symmetric confidence intervals. If the checks had not been satisfied, a warning would have been provided.
- N74: This plot is the unnormed probability density for the tally fluctuation chart bin of tally 11. The probability density is the number of tallies plotted (horizontal) against the value of the tally (vertical). The central mean is denoted by the line of m's. If a problem has been undersampled, this plot will often show "holes," or unsampled regions of the PDF. If the slope is less than 10, this plot will also show a curve of S's which represent the Pareto curve fit to the PDF. This allows the user to visually compare the curve fit to the calculated distribution. The total  $1.14\text{E-}1$  is 1143 tallies from 10000 histories.

-Table 162-

- N75: This plot is the cumulative number of tallies in the tally fluctuation chart bin of tally 11. It is simply the cumulative version of table 161, or the cumulative probability density function. The ordinate and abscissa values are printed in the left-hand columns and are read as, "785 scores were made with a value of  $7.94328\text{E-}02$  or less and these 785 scores accounted for 68.679% of the total tally." This plot is followed by a plot of the cumulative tally in the tally fluctuation chart bin. These entries are read as "Of the total tally value  $8.11579\text{E-}03$ ,  $2.841\text{E-}3$  (or 35.007%) was from tallies with values less than  $7.943\text{E-}02$ ."

## CHAPTER 5

### TEST1 PROBLEM AND OUTPUT

- N76: Only tally 11 was shown to save space. After all the tallies are printed a summary of statistical checks for all of the tallies is given.
- N77: The tally fluctuation charts always should be studied to see how stable or reliable the tally mean, relative error, variance of the variance, slope, and FOM are, indicating how the problem is converging as a function of history number, NPS. The FOM is defined as  $1/\sigma^2 t$ , where  $\sigma$  is the relative error and  $t$  is the computer time in minutes. In a well-behaved problem,  $t$  is proportional to the number of histories run,  $N$ , and  $\sigma$  is proportional to  $1/\sqrt{N}$ . Thus the *FOM* should rapidly approach a constant value as it does in this problem. Big changes in the *FOM* indicate sampling problems that need attention.

The order of printing tallies is: neutron, photon, combined neutron/photon, electron, and combined photon/electron. Notice that the combined heating tally F6 is exactly the sum of the neutron, F16, and photon, F26, heating tallies.

-Table 190-

- N78: This table is a list of the lower weight window bounds generated by the WWG card. These window bounds are themselves estimated quantities and must be well converged or they can cause more harm than good. When well converged, they can improve efficiency dramatically. Use of these printed weight windows results in an increase of three in the FOM for tally 12 when the problem was rerun. Note that the number of histories per minute is often lower in the more efficient problem because more time is spent sampling important regions of the problem phase space.

These weight windows were chosen to optimize tally 12 as specified on the WWG card. In the subsequent run using these weight windows, the FOM of tally 12 improved by three as did the other photon tallies, and tallies 16 and 34 were slightly degraded. The weight window generator optimizes the importance function for one tally at the expense of all others, if necessary.

Sometimes the calculated lower bound for the photon weight window in a cell is zero, meaning that no photon in that cell ever contributed to the tally of interest in that run. If the zero is unchanged in the run using these windows, the weight cutoff game will be played that cell, sometimes with disastrous consequences. Thus a guess should be made for a lower bound rather than leaving the zero value. A good guess is 10, which is several times higher than the weight window generated for its nearest neighboring cell.

The generated weight windows may be thought of as a forward adjoint solution and thus can provide considerable insight into the physics of a problem. Low weight windows indicate important regions. A low window on a cell bounding the outside world often

indicates that the geometry was truncated and more cells need to be added outside the present geometry. Weight windows that differ greatly between adjacent cells indicate poor weight window convergence or, more likely, a need to subdivide the geometry into smaller phase space units that will have different importances.

Energy dependent weight windows are also available.

-Table 200-

N79: The weight window cards from the weight window generator can, with some file editing, be used instead of the IMP:N and IMP:P cards in the next run of this problem. Zero windows should be replaced with a good guess. Windows differing greatly from those in neighboring cells should be replaced (there are no such cases in this problem). The space between WWN and 1:N must be removed.

We suggest the user read these generated window values from the WWOUT file rather than the editing method just discussed (WWG card, WWINP=WWOUT on the execute line).

N80: With this initial run there are two dumps on the RUNTPE. The first dump occurs at the end of XACT. The second dump is done at the problem end. A continue-run will pick up from this second dump and add a third dump to the RUNTPE when it finishes. CTM = 3.29 is the computer time in minutes used in the transport portion of the problem.

N81: One or more reasons are always given as to why the run was terminated. If there are no errors, most runs terminate after the desired number of particles are run or by a time limit. Computer time = 3.29 minutes is the total time for the problem, including initiation, output, etc.



## CHAPTER 5 CONC PROBLEM AND OUTPUT

### *III. CONC PROBLEM AND OUTPUT*

This simple problem illustrates how to use and interpret results from detectors. It also shows how the statistical checks can reveal deficiencies in the output of an otherwise well-behaved problem. The problem consists of a spherical shell of concrete with a 390-cm outer radius and a 360-cm inner radius. A 14 MeV point isotropic neutron source is at 0,0,0, the center of the void region. It is a neutron-only problem (MODE N), with a neutron lower energy cutoff at 12 MeV. A surface flux tally is used in addition to point and ring detectors.

Even though this is a simple problem, it is difficult, and even inappropriate, for the F65 point detector. Detectors are inappropriate when particles can be transported readily to the region of interest and another type of tally, such as the F2 surface flux tally, can be used. Also, detectors do not work well close to or in scattering regions. A detailed discussion of this problem is presented in Chapter 2, page 2–150.

The following notes on the output describe the pertinent details dealing with the point detector results. The notes will provide a description of the TFC bin checks that test the tally for its reliability. This problem dramatically illustrates the importance of the VOV (variance of the variance) and the PDF (probability density function) slope checks in determining the reliability of the results.

The following notes apply to the CONC problem output file. Only the default print tables appear because there is no PRINT card.

lmcnp version 4c ld=01/20/00 07/18/00 12:56:34  
 \*\*\*\*\*  
 Nlmp=conc name=conc. probid = 07/18/00 12:56:34

```

1- conc: 30 concrete shell with a point 14 MeV source in the center
2- C ex=500
3- 1 0 -1
4- 2 1 -2.3 1 -2
5- 3 0 2 -3
6- 4 0 3 -4
7- 5 0 4
8-
9- 1 so 360
10- 2 so 390
11- 3 so 420
12- 4 so 4000
13-
14- sdef
15- imp:n 1 3r 0
16- ml 1001.60c 1.68756E-01
17- 8016.60c 5.62493E-01
18- 11023.60c 1.18366E-02
19- 12000.60c 1.39951E-03
20- 13027.60c 2.14316E-02
21- 14000.60c 2.04076E-01
22- 19000.60c 5.65495E-03
23- 20000.60c 1.86720E-02
24- 26054.60c 2.47295E-04
25- 26056.60c 3.91067E-03
26- 26057.60c 9.38014E-05
27- 26058.60c 1.19384E-05
28- 6012.50c 1.41730E-03
29-
30- c surface, point, and ring tallies
31- f2:n 4
32- e2 12.5 2i 14. c
33- f12:n 3
34- f22:n 2
35- f25:n 0 -4000 0 0
36- f35:n 0 4000 0 0
37- f45:n 0 -420 0 0
38- f55:n 0 420 0 0
39- f65:n 0 -390 0 -0.5
40- f75:n 0 390 0 -0.5
41- f85:n 0 4000 0
42- f95:n 0 420 0
43- f105:n 0 390 -0.5
44- e0 12.5 2i 14.

```

# CHAPTER 5 CONC PROBLEM AND OUTPUT

**N445-** dd 0.1 1e100  
 46- c  
 47- c cutoff the neutrons at 12 MeV  
**N548-** cut:n j 12.0  
 49- nps 14000  
 1cells

print table 60

cell	mat	atom density	gram density	volume	mass	pieces	neutron importance
1	1	0	0.00000E+00	1.95432E+08	0.00000E+00	1	1.00000E+00
2	2	1	8.14382E-02	2.30000E+00	5.30427E+07	1.21998E+08	1.00000E+00
3	3	0	0.00000E+00	0.00000E+00	6.18642E+07	0.00000E+00	1.00000E+00
4	4	0	0.00000E+00	0.00000E+00	2.67772E+11	0.00000E+00	1.00000E+00
5	5	0	0.00000E+00	0.00000E+00	0.00000E+00	0.00000E+00	0.00000E+00

total 2.68083E+11 1.21998E+08

minimum source weight = 1.00000E+00 maximum source weight = 1.00000E+00

1cross-section tables

print table 100

table length

tables from file endf602

1001.60c	488	1-h-1	from endf-vi.1	mat 125	11/25/93
8016.60c	7725	8-o-16	from endf/b-vi	25	11/25/93
11023.60c	1433	11-na-23	from endf/b-vi.1	mat1125	11/25/93
12000.60c	5743	12-mg-nat	from endf/b-vi	mat1200	11/25/93
13027.60c	5790	13-al-27	from endf/b-vi	mat1325	11/25/93
14000.60c	7846	14-si-nat	from endf/b-vi	mat1400	11/25/93
19000.60c	1981	19-k-nat	from endf/b-vi	mat1900	11/25/93
20000.60c	8534	20-ca-nat	from endf/b-vi	mat2000	11/25/93
26054.60c	6047	endf/b-vi.1	fe54a	mat2625	11/25/93
26056.60c	17615	endf/b-vi.1	fe56a	mat2631	11/25/93
26057.60c	7045	endf/b-vi.1	fe57a	mat2634	11/25/93
26058.60c	5702	endf/b-vi.1	fe58a	mat2637	11/25/93

tables from file rmccs2

6012.50c	3844	njoy	( 1306)	79/07/31.
----------	------	------	---------	-----------

total 79793

neutron cross sections outside the range from 1.20000E+01 to 1.00000E+37 mev are expunged.

decimal words of dynamically allocated storage

```

general      10092
tallies     79288
bank        46724
cross sections 159586

```

total 249322 = 997288 bytes

```

*****
dump no. 1 on file conc.r      nps = 0      coll = 0      ctm = 0.00      nrn = 0

```

**N6**problem summary

run terminated when 14000 particle histories were done.

```

+
0 conc: 30 concrete shell with a point 14 MeV source in the center      07/18/00 12:57:14
                                probid = 07/18/00 12:56:34

```

neutron creation	tracks	weight (per source particle)	energy	neutron loss	tracks	weight (per source particle)	energy
source	14000	1.0000E+00	1.4000E+01	escape	1568	8.6876E-02	1.1939E+00
weight window	0	0.	0.	energy cutoff	12673	6.7294E-01	3.6320E+00
cell importance	0	0.	0.	time cutoff	0	0.	0.
weight cutoff	0	1.5341E-04	1.9648E-03	weight window	0	0.	0.
energy importance	0	0.	0.	cell importance	0	0.	0.
dxtran	0	0.	0.	weight cutoff	16	2.6504E-04	3.3844E-03
forced collisions	0	0.	0.	energy importance	0	0.	0.
exp. transform	0	0.	0.	dxtran	0	0.	0.
upscattering	0	0.	0.	forced collisions	0	0.	0.
delayed fission	0	0.	0.	exp. transform	0	0.	0.
(n,xn)	514	2.5795E-02	6.2067E-02	downscattering	0	0.	5.5765E+00
prompt fission	0	0.	0.	capture	0	2.5297E-01	3.4795E+00
total	14514	1.0259E+00	1.4064E+01	loss to (n,xn)	257	1.2898E-02	1.7868E-01
				loss to fission	0	0.	0.
				total	14514	1.0259E+00	1.4064E+01

number of neutrons banked	0	average time of (shakes)	cutoffs
neutron tracks per source particle	1.0367E+00	escape	tco 1.0000E+34
neutron collisions per source particle	1.8890E+00	capture	eco 1.2000E+01
total neutron collisions	26446	capture or escape	wc1 -5.0000E-01
net multiplication	1.0129E+00 0.0008	any termination	wc2 -2.5000E-01

```

computer time so far in this run      0.61 minutes      0      maximum number ever in bank
computer time in mcrun                0.28 minutes      0      bank overflows to backup file
source particles per minute            4.9296E+04      997304 bytes,
random numbers generated               421786      most random numbers used was 160 in history      4334

```

# CHAPTER 5 CONC PROBLEM AND OUTPUT

range of sampled source weights = 1.0000E+00 to 1.0000E+00  
 ln neutron activity in each cell

print table 126

cell	tracks entering	population	collisions	collisions * weight (per history)	number weighted energy	flux weighted energy	average track weight (relative)	average track mfp (cm)
1	14145	14000	0	0.0000E+00	1.3989E+01	1.3989E+01	9.9715E-01	0.0000E+00
2	14145	14000	26446	1.6648E+00	1.3745E+01	1.3755E+01	8.8157E-01	8.0847E+00
3	1568	1568	0	0.0000E+00	1.3679E+01	1.3687E+01	7.5956E-01	0.0000E+00
4	1568	1568	0	0.0000E+00	1.3733E+01	1.3740E+01	7.7460E-01	0.0000E+00
total	31426	31136	26446	1.6648E+00				

ltally 2 nps = 14000  
 tally type 2 particle flux averaged over a surface. units 1/cm\*\*2  
 tally for neutrons

**N7**  
 energy bins are cumulative.

areas  
 surface: 4  
 2.01062E+08

surface 4  
 energy  
 1.2500E+01 1.43092E-11 0.1277  
 1.3000E+01 3.32372E-11 0.0848  
 1.3500E+01 6.70291E-11 0.0593  
 1.4000E+01 4.32412E-10 0.0244

SKIP 703 LINES OF OUTPUT

ltally 65 nps = 14000  
 tally type 5 particle flux at a point detector. units 1/cm\*\*2  
 tally for neutrons

detector located at x,y,z = 0.00000E+00-3.90000E+02 0.00000E+00  
 energy  
 1.2500E+01 6.95657E-10 0.7722  
 1.3000E+01 9.43523E-10 0.6869  
 1.3500E+01 2.27344E-10 0.4054  
 1.4000E+01 1.31533E-08 0.0096  
 total 1.50198E-08 0.0620

detector located at x,y,z = 0.00000E+00-3.90000E+02 0.00000E+00  
 uncollided neutron flux  
 energy  
 1.2500E+01 0.00000E+00 0.0000  
 1.3000E+01 0.00000E+00 0.0000  
 1.3500E+01 0.00000E+00 0.0000  
 1.4000E+01 1.29226E-08 0.0000

```

total      1.29226E-08 0.0000

N8 detector score diagnostics
times average score      transmissions      cumulative      tally      cumulative
*a* 1.0000E-01          4071          0.22336          1.91294E-11          fraction of
*b* 1.0000E+00          13841         0.98277          1.27537E-08          total tally
2.0000E+00              12          0.98343          1.78407E-11          0.00127
5.0000E+00              6          0.98376          2.03013E-11          0.85040
1.0000E+01              7          0.98414          5.12260E-11          0.85158
1.0000E+02             23          0.98541          8.76880E-10          0.85294
1.0000E+03              2          0.98552          1.09590E-09          0.85635
1.0000E+38              0          0.98552          0.00000E+00          0.91473
1st 200 histories          264          1.00000          1.84875E-10          0.98769
                                1.00000                                0.98769
                                1.00000                                1.00000

average tally per history = 1.50198E-08      largest score = 7.92170E-06
(largest score)/(average tally) = 5.27417E+02      nps of largest score = 6698

score contributions by cell
cell  misses  hits  tally per history  weight per hit
1     1       0  *c* 14000          1.29226E-08      1.29226E-08
2     2     19611 *d* 4226          2.09721E-09      6.94769E-09
total 19611 *e* 18226          1.50198E-08      1.15372E-08

score misses
russian roulette on pd          0
psc=0.                          1929
russian roulette in transmission 562
underflow in transmission       0
hit a zero-importance cell      0
energy cutoff                   17120

lanalysis of the results in the tally fluctuation chart bin (tfc) for tally 65 with nps = 14000 print table 160

normed average tally per history = 1.50198E-08      unnormed average tally per history = 1.50198E-08
estimated tally relative error = 0.0620            estimated variance of the variance = 0.4479
relative error from zero tallies = 0.0000          relative error from nonzero scores = 0.0620

number of nonzero history tallies = 14000          efficiency for the nonzero tallies = 1.0000
history number of largest tally = 6698             largest unnormalized history tally = 9.96753E-06
*f*(largest tally)/(average tally) = 6.63626E+02   (largest tally)/(avg nonzero tally) = 6.63626E+02

(confidence interval shift)/mean = 0.0199          shifted confidence interval center = 1.53193E-08

N9 if the largest history score sampled so far were to occur on the next history, the tfc bin quantities would change as follows:

estimated quantities      value at nps      value at nps+1      value(nps+1)/(value(nps)-1.

```



id	nps	mean	error	vov	slope	fom	mean	error	vov	slope	fom	mean	error	vov	slope	fom
6.31-07	0	0.00+00	0.000													
7.94-07	0	0.00+00	0.000													
1.00-06	0	0.00+00	0.000													
1.26-06	2	5.52+02	2.742	*****	****											
1.58-06	1	2.19+02	2.341	*****	****											
2.00-06	1	1.74+02	2.241	*****	****											
2.51-06	0	0.00+00	0.000													
3.16-06	1	1.10+02	2.041	*****												
3.98-06	0	0.00+00	0.000													
5.01-06	0	0.00+00	0.000													
6.31-06	0	0.00+00	0.000													
7.94-06	1	4.37+01	1.641	**												
1.00-05	1	3.47+01	1.541	*												
total	14000	1.00+00														

SKIP 554 LINES OF OUTPUT

**N12**tally fluctuation charts

nps	tally 2					tally 12					tally 22				
	mean	error	vov	slope	fom	mean	error	vov	slope	fom	mean	error	vov	slope	fom
1000	4.7068E-10	0.0876	0.0068	0.0	7313	4.7567E-08	0.0876	0.0075	0.0	7308	5.8922E-08	0.0971	0.0685	0.0	5947
2000	4.2275E-10	0.0653	0.0039	0.0	6375	4.2930E-08	0.0656	0.0046	0.0	6316	5.3176E-08	0.0715	0.0290	0.0	5314
3000	4.3409E-10	0.0525	0.0025	0.0	6470	4.3773E-08	0.0526	0.0028	0.0	6451	5.3670E-08	0.0562	0.0154	0.0	5657
4000	4.4451E-10	0.0448	0.0018	0.0	6589	4.5086E-08	0.0449	0.0020	0.0	6555	5.5571E-08	0.0481	0.0109	0.0	5701
5000	4.3402E-10	0.0407	0.0015	10.0	6179	4.3893E-08	0.0408	0.0017	10.0	6149	5.3928E-08	0.0434	0.0081	6.1	5419
6000	4.3257E-10	0.0373	0.0013	10.0	6111	4.3604E-08	0.0373	0.0014	10.0	6084	5.3513E-08	0.0397	0.0064	4.5	5376
7000	4.3106E-10	0.0346	0.0011	10.0	5997	4.3644E-08	0.0347	0.0012	10.0	5957	5.3608E-08	0.0368	0.0051	5.8	5297
8000	4.2402E-10	0.0327	0.0010	10.0	5858	4.2792E-08	0.0328	0.0011	10.0	5818	5.2434E-08	0.0346	0.0043	6.8	5207
9000	4.2702E-10	0.0307	0.0009	10.0	5905	4.3025E-08	0.0308	0.0010	10.0	5873	5.2555E-08	0.0324	0.0036	4.9	5306
10000	4.2944E-10	0.0290	0.0008	10.0	5886	4.3157E-08	0.0291	0.0008	10.0	5864	5.2550E-08	0.0305	0.0030	3.6	5344
11000	4.3427E-10	0.0275	0.0007	10.0	5953	4.3540E-08	0.0276	0.0007	10.0	5942	5.2867E-08	0.0288	0.0026	4.3	5458
12000	4.3401E-10	0.0264	0.0006	10.0	5953	4.3602E-08	0.0264	0.0007	10.0	5945	5.2961E-08	0.0275	0.0023	5.3	5481
13000	4.3445E-10	0.0253	0.0006	10.0	5953	4.3746E-08	0.0253	0.0006	10.0	5938	5.3617E-08	0.0276	0.0109	3.2	5015
14000	4.3241E-10	0.0244	0.0005	10.0	5899	4.3519E-08	0.0244	0.0006	10.0	5891	5.3284E-08	0.0265	0.0098	3.5	5012

nps	tally 25					tally 35					tally 45				
	mean	error	vov	slope	fom	mean	error	vov	slope	fom	mean	error	vov	slope	fom
1000	4.3003E-10	0.1894	0.3080	2.2	1563	4.4792E-10	0.1596	0.1612	2.6	2201	1.5987E-08	0.1572	0.4035	1.3	2269
2000	4.9422E-10	0.1342	0.1158	2.0	1508	3.9840E-10	0.1174	0.1139	2.3	1971	2.2806E-08	0.3296	0.8828	1.3	250
3000	4.6236E-10	0.1055	0.0852	2.0	1604	4.3304E-10	0.0968	0.0813	2.3	1905	5.1530E-08	0.6212	0.9507	1.2	46
4000	4.6662E-10	0.0921	0.0610	2.1	1557	4.5852E-10	0.0905	0.0804	2.2	1614	4.2554E-08	0.5646	0.9482	1.2	41
5000	4.4901E-10	0.0802	0.0520	2.0	1589	4.5054E-10	0.0778	0.0664	2.4	1688	3.8499E-08	0.5004	0.9401	1.2	41
6000	4.3176E-10	0.0711	0.0479	2.4	1681	4.3363E-10	0.0689	0.0611	2.7	1790	3.4036E-08	0.4717	0.9401	1.3	38
7000	4.5114E-10	0.0658	0.0388	2.7	1653	4.3277E-10	0.0621	0.0514	2.9	1856	4.6830E-08	0.4339	0.4898	1.3	38
8000	4.3486E-10	0.0610	0.0362	2.9	1681	4.3543E-10	0.0587	0.0403	3.4	1813	4.2681E-08	0.4166	0.4898	1.4	36
9000	4.2029E-10	0.0572	0.0339	3.1	1699	4.3790E-10	0.0553	0.0347	3.7	1816	3.9306E-08	0.4021	0.4898	1.4	34
10000	4.1498E-10	0.0541	0.0308	3.1	1699	4.2707E-10	0.0520	0.0326	4.1	1838	3.6630E-08	0.3884	0.4898	1.4	33
11000	4.1164E-10	0.0515	0.0284	3.1	1703	4.4293E-10	0.0494	0.0268	4.4	1851	3.4458E-08	0.3753	0.4897	1.5	32
12000	4.1067E-10	0.0487	0.0257	3.9	1744	4.4056E-10	0.0468	0.0244	4.6	1884	3.3080E-08	0.3587	0.4883	1.4	32



# CHAPTER 5 CONC PROBLEM AND OUTPUT

nps	tally 55				tally 65				tally 75						
	mean	error	vov	slope	fom	mean	error	vov	slope	fom	mean	error	vov	slope	fom
13000	4.0983E-10	0.0459	0.0239	4.5	1804	4.3922E-10	0.0458	0.0241	5.1	1815	3.2244E-08	0.3400	0.4862	1.3	33
14000	4.1441E-10	0.0444	0.0210	4.6	1788	4.3043E-10	0.0438	0.0232	5.2	1833	3.1520E-08	0.3237	0.4823	1.4	34
1000	1.2948E-08	0.0640	0.4349	1.3	13703	1.3031E-08	0.0062	0.9837	1.8	1458748	1.2970E-08	0.0018	0.9031	2.0	1.7E+07
2000	1.6116E-08	0.1796	0.5871	1.3	842	1.3893E-08	0.0567	0.9588	1.7	8444	1.3262E-08	0.0162	0.5148	1.9	103449
3000	2.0729E-08	0.1568	0.1859	1.3	727	1.3747E-08	0.0391	0.8777	1.7	11696	1.3798E-08	0.0351	0.7769	1.6	14454
4000	1.9257E-08	0.1297	0.1702	1.4	786	1.3659E-08	0.0306	0.7616	1.7	14103	1.5296E-08	0.1119	0.9120	1.6	1055
5000	1.8678E-08	0.1139	0.1421	1.4	787	1.3993E-08	0.0351	0.4095	1.6	8298	1.4827E-08	0.0924	0.9121	1.5	1198
6000	1.9004E-08	0.1117	0.1478	1.4	680	1.3822E-08	0.0296	0.4095	1.6	9678	1.4793E-08	0.0789	0.8353	1.5	1362
7000	1.8810E-08	0.1009	0.1282	1.5	703	1.6194E-08	0.1116	0.5009	1.5	575	1.4715E-08	0.0684	0.8145	1.5	1529
8000	2.1095E-08	0.1475	0.5038	1.3	287	1.5802E-08	0.1001	0.5010	1.5	624	1.5333E-08	0.0791	0.4496	1.4	999
9000	2.2176E-08	0.1323	0.4022	1.3	318	1.5509E-08	0.0907	0.5007	1.4	725	1.5320E-08	0.0713	0.4263	1.4	1093
10000	2.1091E-08	0.1252	0.4022	1.2	317	1.5300E-08	0.0828	0.4994	1.4	676	1.5084E-08	0.0652	0.4263	1.4	1169
11000	2.2194E-08	0.1247	0.2687	1.2	290	1.5096E-08	0.0763	0.4994	1.4	776	1.5189E-08	0.0616	0.3624	1.4	1189
12000	2.2296E-08	0.1184	0.2341	1.3	295	1.5018E-08	0.0706	0.4906	1.4	830	1.5033E-08	0.0571	0.3618	1.4	1268
13000	2.4274E-08	0.1530	0.3679	1.3	163	1.5158E-08	0.0661	0.4480	1.4	872	1.6616E-08	0.1152	0.6972	1.4	287
14000	2.4154E-08	0.1456	0.3420	1.4	166	1.5020E-08	0.0620	0.4479	1.4	917	1.6359E-08	0.1087	0.6972	1.4	298

ltally fluctuation charts

nps	tally 85				tally 95				tally 105						
	mean	error	vov	slope	fom	mean	error	vov	slope	fom	mean	error	vov	slope	fom
1000	4.6893E-10	0.1150	0.0940	3.1	4237	3.7894E-08	0.3062	0.6184	1.7	598	3.1655E-08	0.2324	0.5702	1.3	1038
2000	4.5072E-10	0.0754	0.0503	3.3	4773	3.1910E-08	0.1915	0.5058	1.8	741	7.0026E-08	0.5600	0.9385	1.3	87
3000	4.5901E-10	0.0597	0.0296	4.2	5012	2.8192E-08	0.1470	0.4726	1.9	826	5.7102E-08	0.4603	0.9189	1.3	84
4000	4.7243E-10	0.0551	0.0277	2.9	4351	2.8978E-08	0.1196	0.3186	1.9	924	4.8966E-08	0.4030	0.9156	1.4	81
5000	4.6252E-10	0.0503	0.0241	2.9	4034	3.4948E-08	0.1418	0.3532	1.9	508	4.9120E-08	0.3254	0.8720	1.4	97
6000	4.5707E-10	0.0467	0.0221	3.7	3898	3.6619E-08	0.1239	0.2512	2.0	553	4.5316E-08	0.2943	0.8673	1.5	98
7000	4.4496E-10	0.0430	0.0201	3.8	3872	3.5555E-08	0.1108	0.2390	2.2	584	4.7860E-08	0.2480	0.7483	1.6	116
8000	4.3427E-10	0.0397	0.0182	4.3	3969	3.6111E-08	0.1029	0.1883	2.4	590	4.4972E-08	0.2312	0.7456	1.7	117
9000	4.3578E-10	0.0376	0.0157	4.6	3937	3.5384E-08	0.0944	0.1804	2.6	624	5.1731E-08	0.2129	0.4267	1.9	123
10000	4.3122E-10	0.0353	0.0143	4.9	3977	3.8466E-08	0.1031	0.1700	2.4	468	5.0118E-08	0.1987	0.4189	1.9	126
11000	4.3632E-10	0.0339	0.0130	5.6	3919	3.8983E-08	0.0956	0.1499	2.4	494	4.9698E-08	0.1836	0.4060	2.0	134
12000	4.3565E-10	0.0325	0.0119	7.5	3915	3.8267E-08	0.0900	0.1450	2.5	510	4.9341E-08	0.1737	0.3705	2.0	137
13000	4.3031E-10	0.0310	0.0112	8.9	3955	3.8663E-08	0.0851	0.1280	2.6	526	5.0503E-08	0.1675	0.2987	2.0	136
14000	4.3184E-10	0.0297	0.0102	10.0	3980	3.8499E-08	0.0801	0.1235	2.8	549	4.8699E-08	0.1614	0.2976	2.1	135

\*\*\*\*\*  
dump no. 2 on file conc.r nps = 14000 coll = 26446 ctm = 0.28 nrrn = 421786

9 warning messages so far.  
run terminated when 14000 particle histories were done.  
computer time = 0.33 minutes  
mcnp version 4c 01/20/00

probid = 07/18/00 12:56:34

07/18/00 12:57:14

**Notes:**

- N1: MCNP was run with the name execute line option that renames the output file conc.o and the continue-run file conc.r.
- N2: The point detector for tally 65 is placed on surface 2 (at 0,-390,0) with a sphere of exclusion of .5 mean free paths. This tally is a good example of what NOT to do when using point detectors. First of all, the point detector (or ring detector) should not be placed directly on a surface, especially if the cell on one side has a zero importance. As a rule of thumb, the point detector should lie just inside or outside a surface. Another significant item about this tally is that the radius of the sphere of exclusion is expressed as 0.5 mean free paths. It is generally not recommended to use a radius expressed in mean free paths because this increases the variance of the tally. However, the radius can be entered in mean free paths if the user does not know what other value to use. The fictitious sphere radius of 0.5 mean free paths (approximately 4.3 cm) assumes a uniform isotropic flux within the sphere. Although this assumption will smooth out the detector response, it is false. The fictitious sphere should never be in more than one material medium as it is here because the material is assumed to be uniform throughout the sphere. This point detector is included in the example to demonstrate how MCNP can sometimes be fooled into giving supposedly accurate results.
- N3: The ring detector for tally 95 is about the y-axis centered at the origin. The radius of the ring is 420 cm and it is coincident with surface 3. The radius of the sphere of exclusion for this detector is set to 0. Because the detector lies in a void region, it will not produce erroneous results if coincident with a geometric surface.
- N4: The DD card controls the Russian roulette games that are played for all detector problems unless explicitly turned off. The first entry of this card, 0.1, designates the level at which Russian roulette will be played. For the first 200 histories, all contributions to the detector are counted. The average then is computed and is updated whenever the tally fluctuation chart entry is computed. Russian roulette is played on all contributions below 0.1 times the computed average. This Russian roulette game is one of the few default MCNP variance reduction schemes and typically speeds up detector problems by an order of magnitude. The second entry on the DD card causes a diagnostic message to be printed if a tally greater than  $0.1 * 1e100$  is reached (which in this case is never). If this second entry is too high, the diagnostic messages will never be printed, conversely, if this number is too low, the output will be cluttered with these messages.
- N5: The cutoff card for this problem uses the default time cutoff value and an energy cutoff of 12.0 MeV. If a neutron time is greater than the time entry or if the neutron energy is below 12 MeV, the particle is terminated. These cutoff parameters can reduce computational time, but they should be used with caution. In some applications, ignoring

## CHAPTER 5

### CONC PROBLEM AND OUTPUT

neutrons and photons beneath a certain energy cutoff will not significantly affect the tally. But, if these lower energy interactions are important (fission and photon interactions) then the final result may be truncated.

- N6: The problem summary table provides an accounting of particle track, weight, and energy creation and loss. For this problem, the largest neutron loss was caused by energy cutoff. There is a total of 26,446 collisions for 14,000 source histories. The net multiplication of 1.0129 is caused by (n,xn) reactions; the system is clearly not supercritical because there is no fissionable material. The weight per escaping source particle is 0.086876, meaning that the flux on the shell of radius 4000 cm is approximately  $0.086876/(4\pi \cdot 4000^2) = 4.321E-10$  neutrons/cm<sup>2</sup>. The energy cutoff terminated 12673 tracks out of 14000 starting particles, making for a very fast problem run time.
- N7: The energy bins for tally 2 are cumulative so that any particle with energy less than or equal to the energy of a bin scores in that bin.
- N8: The letters \*a\*, etc, throughout the diagnostics table correspond to the notes, (a),(b), etc. There were 18226 detector contributions (e). 14000 were from the source (there were 14000 hits from cell 1)(c) and 4226 from collisions inside cell 2 (d). According to the problem summary there were 26,446 collisions. Thus the DD card roulette game eliminated 84% of the collision contributions. Of the 4226 collisions that did contribute to the tally, 4071 (a) made a tally less than the 1E-1 cutoff (it was conservatively estimated that their contributions would be higher so that they would not be rouletted). These 4071 transmissions to the detector contributed only 0.127% of the cumulative fraction of total tally(a). The majority of the total tally was contributed by transmissions with an average score of 1.0 or less (b); these scores accounted for 85.04% of the total tally. The remaining fraction of the tally was contributed by the transmissions with scores greater than 1.0. The largest tally is 663.63 times larger than the average tally(f).
- N9: This section describes how the TFC bins would be affected if the largest previously sampled score was encountered on the next history. The “value at nps” column shows the TFC bin values of the current history, while the “value at nps+1” column shows the results after the largest previous history has been added to the tally. The last column shows the relative change of the TFC bin values from the NPS value to the NPS+1 value. The effect of having a very large score on the next history appears to have an overall detrimental effect on these TFC values. The relative error increased by 20% while the figure of merit decreased by 31%. One positive effect is that the VOV decreased by 29.8% (to 0.314281), however, it was still not beneath the required value of 0.1.
- N10: This problem passed only five of the ten TFC bin statistical checks, clearly a bad sign. The relative error (RE) was more than 5%. The VOV was not below the required 0.1 maximum and is not decreasing as 1/NPS. The probability density function (PDF) slope

was not greater than 3. Both indicate that the problem was not sampled adequately. Undersampling of infrequent high scoring tallies gives a result with an underpredicted RE and variance. The VOV is more sensitive to large tally score fluctuations than the RE, and is one good indicator of confidence interval reliability. The PDF slope check confirms whether the PDF function's high score tail is decreasing with at least a  $1/x^3$  dependence. If the high score tail follows this criteria, then the Central Limit Theorem is satisfied and the distribution should converge to a normal distribution if enough histories are run. It can be seen that a low relative error and variance do not always guarantee a reliable result. These ten statistical checks do not ensure a totally reliable result; they just provide a more rigorous check of the tally reliability.

- N11: This plot is the unnormed probability density for tally 65. It is a log-log plot of the PDF that is shown by asterisks, along with the central mean (denoted by the line of m's). The curve of S's denotes the Pareto curve fit to the PDF distribution. This curve is included so that the user can see if the fit is fairly accurate when compared to the calculated distribution. To the left of the plot are the columns that show the abscissa, number, number density and the ordinate of the PDF.
- N12: These are the TFC bin results all of the tallies. For the tally 65 point detector, the RE is just above 5%, the FOM is decent, and the answer is wrong. To ensure a reliable confidence interval, the acceptable value of the VOV is 0.1. As mentioned previously, the VOV checks the higher moments (3rd and 4th) of the PDF because they are more sensitive to any aberrations in the PDF caused by insufficient sampling. For this tally, the VOV of 0.4479 clearly does not fall below the acceptable limit of 0.1. To achieve a reliable confidence interval, the slope of the PDF must be greater than or equal to three in order to produce a distribution that has a  $1/x^3$  behavior. The tally also fails this criterion, indicating that the Central Limit Theorem is not satisfied. Tally 65 appears to have converged to a flux of 1.5020E-08. However, surface tally 22 at 390 cm is 5.3284E-08 and the still-unconverged ring detector tally 105 at 390 cm is 4.8699E-08. Tally 65 appears from its relative error to be close to convergence but it is actually low by a factor of 4! Tallies 25 and 35 at 4000 cm agree with to the flux extracted from the problem summary (see note N6), namely 4.321E-10.

**COMMENTS:**

How should the CONC problem be better specified? First, detectors are inappropriate for this problem and should not be used. The shell should be divided into four spherically concentric geometrical regions with outwardly increasing importances of 1, 2, 4 and 8. Then for every source particle, approximately one particle would cross the outer surface of the shell and score, instead of the present 14381 out of 100000.

## CHAPTER 5

### CONC PROBLEM AND OUTPUT

How could detectors be made to work better in this problem? In any problem with symmetry, a ring detector rather than a point detector should be used to at least take advantage of the symmetry. The fictitious sphere radius could be made smaller so that the  $1/r^2$  singularity made about as much difference as the fluctuation in PSC value. Perhaps this fictitious sphere radius would be 1 cm. Most importantly, the source direction could be biased to direct particles at the ring, causing a lot more collisions in the vicinity of the detector.

#### *IV. KCODE*

The problem selected to illustrate the output from a criticality calculation is the one-dimensional model of the GODIVA critical assembly, composed of about 94%  $^{235}\text{U}$ . This assembly is one of several fast neutron critical assemblies discussed in LA-4208 entitled “Reevaluated Critical Specifications of Some Los Alamos Fast-Neutron Systems” by G. E. Hansen and H. C. Paxton (September 1964).

An MCNP input file that models GODIVA and performs only the criticality calculation with no separate tallies would be only 11 lines long. The KCODE card indicates that the problem is a criticality calculation for the  $k_{eff}$  eigenvalue. To perform this same calculation with neutron-induced photon production, add the MODE N P card. Any tallies that are made in a criticality problem are normalized to the starting weight (default) or number of particles as defined by the user (see Chapter 2, section VIII for details). Tallies should be scaled for the appropriate steady state neutron generation rate.

Following is a partial listing of the output from a KCODE calculation. The pages selected emphasize the criticality aspects of the problem.

```

N1lmcnp version 4c ld=01/20/00 07/31/00 12:11:37
*****
inp=kcode name=kcode. probid = 07/31/00 12:11:37

1- bare u(94) sphere ref. la-4208, g. e. hansen and h. c. paxton, 1969, page 4
2- 1 10 -18.74 -1
3- 2 0 1
4-
5- 1 so 8.7037
6-
7- imp:n 1 0
N2 8- m10 92235.61c 0.045217 92238.61c 0.0024355 92234.61c 0.0004935
N3 9- kcode 3000 1. 5 35
N410- ksrc 0 0 0
11- print
12- C
13- C Perturbations
N514- pertl:n cell=1 rho=-20.0 method=-1 $ perterb density and give changes
15- c
16- c tallies
17- c
18- fl:n 1
19- fl4:n 1
20- fc14 total total fission neutrons (track-length Keff), total loss to (n,xn)
21- total neutron absorptions,total fission,and neutron heating (mev/gram)
22- fq14 e m
N623- fm14 (132.534 10 (-6 -7) (16:17) (-2) (-6)) (0.002560689 10 1 -4)
24- f6:n 1
25- f7:n 1
26- c
27- c use the sixteen group hansen-roach energy structure as the default
28- c
N729- e0 1-7 4-7 1-6 3-6 1-5 3-5 1-4 5.5-4 3-3 1.7-2 0.1 0.4 0.9 1.4 3 20.
N830- f34:n 1
31- sd34 1
32- fq34 m f
33- fm34 (-1 10 -6 -7) (-1 10 16:17) (-1 10 -2) (-1 10 -6) (-0.000019321 10 1 -4)
34- e34 20 nt
35-
1 initial source from ksrc card.
N9
original number of points 1
points not in any cell 0
points in cells of zero importance 0
points in void cells 0
points in ambiguous cells 0
print table 90

```

```

total points rejected          0
points remaining              1
points after expansion or contraction 3000
nominal source size          3000

initial guess for k(eff.)      1.000000

cycles to skip before tallying      5

number of keff cycles that can be stored      6500

total fission nubar data are being used.
SKIP 69 LINES in OUTPUT
ltally 14                                print table 30
+
tally type 4 track length estimate of particle flux.
total total fission neutrons (track-length Keff), total loss to (n,xn)
total neutron absorptions, total fission, and neutron heating (mev/gram)
tally for neutrons

```

```

N10 warning.  perturbation may require negative fm constant.  tally 14
warning.  perturbation may require negative fm constant.  tally 14
warning.  perturbation may require negative fm constant.  tally 14
warning.  perturbation may require negative fm constant.  tally 14
warning.  perturbation may require negative fm constant.  tally 14
SKIP 47 LINES IN OUTPUT
material composition
the sum of the fractions of material 10 was 4.814600E-02

```

```

material
number      component nuclide, atom fraction
10      92235, 9.39164E-01      92238, 5.05857E-02      92234, 1.02501E-02

material
number      component nuclide, mass fraction
10      92235, 9.38598E-01      92238, 5.12020E-02      92234, 1.02002E-02

```

```

N11 warning.  1 materials had unnormalized fractions. print table 40.
N12 warning.  perturbation correction not applied to tally 6
warning.  perturbation correction not applied to tally 7

```



lcell volumes and masses

print table 50

**N13**

cell	atom density	gram density	input volume	calculated volume	mass	pieces	reason volume not calculated
1	4.79847E-02	1.87400E+01	0.00000E+00	2.76185E+03	5.17571E+04	1	infinite
2	0.00000E+00	0.00000E+00	0.00000E+00	0.00000E+00	0.00000E+00	0	

SKIP 70 LINES IN OUTPUT  
lcross-section tables

**N14**

table length

tables from file endf6dn2

92234.61c	82031	92-u-234	from endf-vi	total nu	mat9225	11/27/93
92235.61c	234221	92-u-235	from lanl proposed endf-vi.2	total nu	mat9228	11/27/93
92238.61c	184612	92-u-238	from endf-vi.2	total nu	mat9237	11/27/93

total 500864

decimal words of dynamically allocated storage

**N15**

general	532058
tallies	35996
bank	58244
cross sections	1001728
total	1621886 = 6487544 bytes

\*\*\*\*\*  
dump no. 1 on file kcode.r nps = 0 coll = 0 ctm = 0.00 nrn = 0

**N16**

source distribution written to file kcode.s cycle = 0  
8 warning messages so far.  
1 starting mcrun. dynamic storage = 1621890 words, 6487560 bytes. cp0 = 0.03 print table 110  
bare u(94) sphere ref. la-4208, g. e. hansen and h. c. paxton, 1969, page 4.

**N17**

mps	x	y	z	cell	surf	u	v	w	energy	weight	time
1	0.000E+00	0.000E+00	0.000E+00	1	0	5.085E-01	4.733E-01	7.193E-01	2.209E+00	1.000E+00	0.000E+00
2	0.000E+00	0.000E+00	0.000E+00	1	0	8.952E-01	-4.447E-01	-2.944E-02	4.904E+00	1.000E+00	0.000E+00
3	0.000E+00	0.000E+00	0.000E+00	1	0	-6.184E-01	-4.495E-01	6.446E-01	3.809E-01	1.000E+00	0.000E+00
4	0.000E+00	0.000E+00	0.000E+00	1	0	9.710E-01	-5.665E-02	-2.323E-01	1.331E+00	1.000E+00	0.000E+00
5	0.000E+00	0.000E+00	0.000E+00	1	0	5.861E-01	1.496E-01	-7.963E-01	1.902E+00	1.000E+00	0.000E+00

6	0.000E+00	0.000E+00	0.000E+00	0.000E+00	1	0	-6.489E-02	-1.626E-01	9.845E-01	9.845E-01	4.410E-01	1.000E+00	0.000E+00
7	0.000E+00	0.000E+00	0.000E+00	0.000E+00	1	0	-7.068E-02	3.263E-02	-9.970E-01	-9.970E-01	4.750E-01	1.000E+00	0.000E+00
8	0.000E+00	0.000E+00	0.000E+00	0.000E+00	1	0	-3.915E-01	4.664E-01	-7.932E-01	-7.932E-01	4.136E+00	1.000E+00	0.000E+00
9	0.000E+00	0.000E+00	0.000E+00	0.000E+00	1	0	-2.368E-01	9.215E-01	-3.079E-01	-3.079E-01	7.453E-02	1.000E+00	0.000E+00
10	0.000E+00	0.000E+00	0.000E+00	0.000E+00	1	0	-1.946E-01	3.204E-01	9.271E-01	9.271E-01	3.128E+00	1.000E+00	0.000E+00
11	0.000E+00	0.000E+00	0.000E+00	0.000E+00	1	0	-6.698E-01	-7.177E-01	-1.905E-01	-1.905E-01	1.014E+00	1.000E+00	0.000E+00
12	0.000E+00	0.000E+00	0.000E+00	0.000E+00	1	0	-8.398E-01	-4.129E-01	3.524E-01	3.524E-01	1.395E+00	1.000E+00	0.000E+00
13	0.000E+00	0.000E+00	0.000E+00	0.000E+00	1	0	-1.714E-01	-8.572E-01	4.857E-01	4.857E-01	7.748E-01	1.000E+00	0.000E+00
14	0.000E+00	0.000E+00	0.000E+00	0.000E+00	1	0	-2.489E-01	-5.118E-01	-8.222E-01	-8.222E-01	1.101E+00	1.000E+00	0.000E+00
15	0.000E+00	0.000E+00	0.000E+00	0.000E+00	1	0	-2.959E-01	2.119E-01	9.314E-01	9.314E-01	1.951E+00	1.000E+00	0.000E+00
16	0.000E+00	0.000E+00	0.000E+00	0.000E+00	1	0	1.395E-01	-9.829E-01	1.202E-01	1.202E-01	2.186E+00	1.000E+00	0.000E+00
17	0.000E+00	0.000E+00	0.000E+00	0.000E+00	1	0	6.909E-01	-7.110E-01	1.307E-01	1.307E-01	1.865E+00	1.000E+00	0.000E+00
18	0.000E+00	0.000E+00	0.000E+00	0.000E+00	1	0	-6.580E-01	5.320E-01	-5.329E-01	-5.329E-01	1.229E+00	1.000E+00	0.000E+00
19	0.000E+00	0.000E+00	0.000E+00	0.000E+00	1	0	-9.903E-01	-1.380E-01	1.353E-02	1.353E-02	1.305E+00	1.000E+00	0.000E+00
20	0.000E+00	0.000E+00	0.000E+00	0.000E+00	1	0	7.462E-01	4.859E-01	-4.551E-01	-4.551E-01	1.000E+00	1.000E+00	0.000E+00
21	0.000E+00	0.000E+00	0.000E+00	0.000E+00	1	0	-1.977E-01	9.797E-01	3.360E-02	3.360E-02	3.990E+00	1.000E+00	0.000E+00
22	0.000E+00	0.000E+00	0.000E+00	0.000E+00	1	0	-9.117E-01	-3.647E-01	-1.891E-01	-1.891E-01	2.665E-01	1.000E+00	0.000E+00
23	0.000E+00	0.000E+00	0.000E+00	0.000E+00	1	0	4.287E-01	8.361E-01	-3.422E-01	-3.422E-01	1.156E+00	1.000E+00	0.000E+00
24	0.000E+00	0.000E+00	0.000E+00	0.000E+00	1	0	1.080E-01	3.412E-01	-9.338E-01	-9.338E-01	2.669E+00	1.000E+00	0.000E+00
25	0.000E+00	0.000E+00	0.000E+00	0.000E+00	1	0	-9.111E-01	-9.012E-03	-4.122E-01	-4.122E-01	2.185E+00	1.000E+00	0.000E+00
26	0.000E+00	0.000E+00	0.000E+00	0.000E+00	1	0	-2.568E-01	-6.391E-01	-7.249E-01	-7.249E-01	4.225E+00	1.000E+00	0.000E+00
27	0.000E+00	0.000E+00	0.000E+00	0.000E+00	1	0	-2.912E-01	8.086E-01	5.113E-01	5.113E-01	1.079E+00	1.000E+00	0.000E+00
28	0.000E+00	0.000E+00	0.000E+00	0.000E+00	1	0	1.472E-01	-9.514E-01	2.705E-01	2.705E-01	3.461E+00	1.000E+00	0.000E+00
29	0.000E+00	0.000E+00	0.000E+00	0.000E+00	1	0	-6.135E-01	-7.645E-01	-1.978E-01	-1.978E-01	1.836E+00	1.000E+00	0.000E+00
30	0.000E+00	0.000E+00	0.000E+00	0.000E+00	1	0	-5.702E-01	5.651E-01	-5.963E-01	-5.963E-01	4.556E-01	1.000E+00	0.000E+00
31	0.000E+00	0.000E+00	0.000E+00	0.000E+00	1	0	-6.607E-01	5.373E-01	-5.242E-01	-5.242E-01	6.415E-01	1.000E+00	0.000E+00
32	0.000E+00	0.000E+00	0.000E+00	0.000E+00	1	0	-9.742E-02	-3.639E-01	-9.263E-01	-9.263E-01	2.764E+00	1.000E+00	0.000E+00
33	0.000E+00	0.000E+00	0.000E+00	0.000E+00	1	0	-1.965E-01	-3.145E-01	-9.287E-01	-9.287E-01	2.785E-01	1.000E+00	0.000E+00
34	0.000E+00	0.000E+00	0.000E+00	0.000E+00	1	0	4.097E-01	8.465E-01	-3.399E-01	-3.399E-01	9.097E-01	1.000E+00	0.000E+00
35	0.000E+00	0.000E+00	0.000E+00	0.000E+00	1	0	-4.048E-02	8.831E-01	4.675E-01	4.675E-01	3.360E-01	1.000E+00	0.000E+00
36	0.000E+00	0.000E+00	0.000E+00	0.000E+00	1	0	3.371E-01	-9.269E-01	-1.652E-01	-1.652E-01	6.376E-01	1.000E+00	0.000E+00
37	0.000E+00	0.000E+00	0.000E+00	0.000E+00	1	0	-1.867E-01	9.756E-01	-1.155E-01	-1.155E-01	2.186E+00	1.000E+00	0.000E+00
38	0.000E+00	0.000E+00	0.000E+00	0.000E+00	1	0	-2.616E-01	2.336E-01	-9.365E-01	-9.365E-01	7.314E-01	1.000E+00	0.000E+00
39	0.000E+00	0.000E+00	0.000E+00	0.000E+00	1	0	9.780E-01	-7.641E-02	-1.939E-01	-1.939E-01	2.997E-01	1.000E+00	0.000E+00
40	0.000E+00	0.000E+00	0.000E+00	0.000E+00	1	0	2.580E-01	-7.076E-01	6.578E-01	6.578E-01	1.444E+00	1.000E+00	0.000E+00
41	0.000E+00	0.000E+00	0.000E+00	0.000E+00	1	0	-3.212E-01	-7.678E-01	-5.543E-01	-5.543E-01	1.914E+00	1.000E+00	0.000E+00
42	0.000E+00	0.000E+00	0.000E+00	0.000E+00	1	0	5.039E-01	-1.460E-01	8.513E-01	8.513E-01	1.502E+00	1.000E+00	0.000E+00
43	0.000E+00	0.000E+00	0.000E+00	0.000E+00	1	0	6.080E-01	5.487E-01	5.738E-01	5.738E-01	5.971E+00	1.000E+00	0.000E+00
44	0.000E+00	0.000E+00	0.000E+00	0.000E+00	1	0	-2.932E-01	9.304E-01	-2.199E-01	-2.199E-01	1.827E+00	1.000E+00	0.000E+00
45	0.000E+00	0.000E+00	0.000E+00	0.000E+00	1	0	-8.475E-01	-3.993E-01	-3.497E-01	-3.497E-01	1.928E+00	1.000E+00	0.000E+00
46	0.000E+00	0.000E+00	0.000E+00	0.000E+00	1	0	1.200E-01	-9.195E-01	-3.743E-01	-3.743E-01	1.351E+00	1.000E+00	0.000E+00
47	0.000E+00	0.000E+00	0.000E+00	0.000E+00	1	0	7.085E-01	5.879E-01	3.904E-01	3.904E-01	2.288E+00	1.000E+00	0.000E+00
48	0.000E+00	0.000E+00	0.000E+00	0.000E+00	1	0	4.261E-01	9.046E-01	9.254E-03	9.254E-03	1.230E+00	1.000E+00	0.000E+00
49	0.000E+00	0.000E+00	0.000E+00	0.000E+00	1	0	5.431E-01	4.270E-01	-7.230E-01	-7.230E-01	1.433E+00	1.000E+00	0.000E+00
50	0.000E+00	0.000E+00	0.000E+00	0.000E+00	1	0	-1.053E-01	-9.805E-01	1.658E-01	1.658E-01	6.572E-01	1.000E+00	0.000E+00

lestimated keff results by cycle

N18

cycle 1 k(collision) 1.358125 prompt removal lifetime(abs) 9.1005E-01 source points generated 4119

print table 175

# CHAPTER 5 KCODE

cycle	2	k(collission)	1.154061	prompt removal lifetime(abs)	7.1727E-01	source points generated	2562		
cycle	3	k(collission)	1.064506	prompt removal lifetime(abs)	6.6305E-01	source points generated	2784		
cycle	4	k(collission)	1.021321	prompt removal lifetime(abs)	6.4986E-01	source points generated	2867		
cycle	5	k(collission)	1.023708	prompt removal lifetime(abs)	6.5835E-01	source points generated	2971		
cycle	6	k(collission)	0.986612	prompt removal lifetime(abs)	6.2340E-01	source points generated	2887		
estimator		cycle	7	ave of	2 cycles	combination	simple average	combined average	corr
k(collission)			1.017630		1.002121	0.0155	k(col/abs)	0.000000	0.0000
k(adsorption)			1.016863		1.000145	0.0167	k(abs/tk ln)	0.000000	0.0000
k(trk length)			1.000350		0.996914	0.0034	k(tk ln/col)	0.000000	0.0000
rem life(col)			6.2033E-01		6.2210E-01	0.0029	life(col/abs)	0.0000E+00	0.0000
rem life(abs)			6.2043E-01		6.2191E-01	0.0024			
source points generated			3110						
estimator		cycle	8	ave of	3 cycles	combination	simple average	combined average	corr
k(collission)			0.984670		0.996304	0.0107	k(col/abs)	0.995820	0.9935
k(adsorption)			0.985717		0.995336	0.0108	k(abs/tk ln)	0.995518	0.9962
k(trk length)			0.993270		0.995699	0.0023	k(tk ln/col)	0.996002	0.9996
rem life(col)			6.1084E-01		6.1835E-01	0.0063			
rem life(abs)			6.1184E-01		6.1856E-01	0.0056	life(col/abs)	6.1845E-01	0.9999
source points generated			2891						
estimator		cycle	9	ave of	4 cycles	combination	simple average	combined average	corr
k(collission)			0.978535		0.991862	0.0088	k(col/abs)	0.991791	0.9910
k(adsorption)			0.980872		0.991720	0.0085	k(abs/tk ln)	0.990160	0.6206
k(trk length)			0.967305		0.988601	0.0074	k(tk ln/col)	0.990231	0.6885
rem life(col)			6.0996E-01		6.1625E-01	0.0056	k(col/abs/tk ln)	0.990728	0.988013
rem life(abs)			6.0986E-01		6.1638E-01	0.0053	life(col/abs/tl)	6.1588E-01	0.0011
source points generated			3042						
estimator		cycle	10	ave of	5 cycles	combination	simple average	combined average	corr
k(collission)			1.011025		0.995694	0.0078	k(col/abs)	0.995962	0.9895
k(adsorption)			1.014266		0.996229	0.0080	k(abs/tk ln)	0.994777	0.7562
k(trk length)			1.012225		0.993326	0.0074	k(tk ln/col)	0.994510	0.7753
rem life(col)			6.4614E-01		6.2223E-01	0.0105	k(col/abs/tk ln)	0.995083	0.994211
rem life(abs)			6.4614E-01		6.2233E-01	0.0104	life(col/abs/tl)	6.2165E-01	0.0106
source points generated			3073						
SKIP 185 LINES IN OUTPUT									
estimator		cycle	34	ave of	29 cycles	combination	simple average	combined average	corr
k(collission)			1.012300		0.992941	0.0032	k(col/abs)	0.992787	0.9945
k(adsorption)			1.013670		0.992633	0.0033	k(abs/tk ln)	0.993246	0.8487
k(trk length)			1.006845		0.993858	0.0023	k(tk ln/col)	0.993399	0.8539
rem life(col)			6.2892E-01		6.1948E-01	0.0045	k(col/abs/tk ln)	0.993144	0.994148
rem life(abs)			6.2883E-01		6.1972E-01	0.0044	life(col/abs/tl)	6.1933E-01	0.0040
source points generated			3073						

**N19**

```

estimator      cycle      35      ave of      30 cycles      combination      simple average      combined average      corr
k(collision)  1.014312      0.993653  0.0032      k(col/abs)      0.993520  0.0032      0.993675  0.0033      0.9947
k(absorption) 1.015224      0.993386  0.0032      k(abs/tk ln)   0.993694  0.0026      0.994208  0.0022      0.8387
k(trk length) 0.998200      0.994003  0.0022      k(tk ln/col)   0.993828  0.0026      0.994125  0.0022      0.8453
rem life(col) 6.1576E-01    6.1935E-01 0.0043      k(col/abs/tk ln) 0.993681  0.0028      0.994084  0.0022
rem life(abs) 6.1562E-01    6.1959E-01 0.0043      life(col/abs/tl) 6.1924E-01 0.0040      6.1875E-01 0.0038
source points generated 2856
    
```

```

source distribution written to file kcode.s      cycle = 35
lproblem summary (active cycles only)      source particle weight for summary table normalization = 90000.00
    
```

**N20**

```

+ run terminated when 35 kcode cycles were done.
0 bare u(94) sphere ref. la-4208, g. e. hansen and h. c. paxton, 1969, page 4.      prohibd = 07/31/00 12:16:01
    
```

```

neutron creation      tracks      weight      energy      neutron loss      tracks      weight      energy
(per source particle)      (per source particle)
source      89903      1.0000E+00      2.0594E+00      escape      77458      5.7633E-01      9.2165E-01
weight window      0      0.      0.      energy cutoff      0      0.      0.
cell importance      0      0.      0.      time cutoff      0      0.      0.
weight cutoff      0      3.3230E-02      1.2081E-02      weight window      0      0.      0.
energy importance      0      0.      0.      cell importance      0      0.      0.
dxtran      0      0.      0.      weight cutoff      12845      3.2561E-02      1.1439E-02
forced collisions      0      0.      0.      energy importance      0      0.      0.
exp. transform      0      0.      0.      dxtran      0      0.      0.
upscattering      0      0.      0.      forced collisions      0      0.      0.
delayed fission      0      0.      0.      exp. transform      0      0.      0.
prompt fission      0      0.      0.      downscattering      0      0.      0.
total      90701      1.0388E+00      2.0752E+00      capture      0      4.4700E-02      2.7392E-02
    
```

```

number of neutrons banked      471      average time of (shakes)      cutoffs
neutron tracks per source particle      1.0078E+00      escape      6.0468E-01      tco      1.0000E+34
neutron collisions per source particle      4.0471E+00      capture      1.0174E+00      eco      0.0000E+00
total neutron collisions      364239      capture or escape      6.3438E-01      wcl      -5.0000E-01
net multiplication      1.0028E+00      any termination      6.7341E-01      wc2      -2.5000E-01
    
```

```

computer time so far in this run      7.66 minutes      maximum number ever in bank      2
computer time in mcrun      3.81 minutes      bank overflows to backup file      0
source particles per minute      2.7621E+04      dynamic storage      1621890 words,      6487560 bytes.
random numbers generated      5379507      most random numbers used was      445 in history      98676
    
```

```

range of sampled source weights = 7.2833E-01 to 1.1710E+00
lneutron activity in each cell
    
```

print table 126

**CHAPTER 5**  
**KCODE**

cell	1	1	89903	90303	90303	364239	2.6395E+00	8.5689E-01	1.4906E+00	6.7470E-01	2.6346E+00
tracks entering											average track mfp (cm)
total			89903	90303	90303	364239	2.6395E+00				average track weight (relative)
neutron weight balance in each cell -- external events											print table 130
cell	1	1	0.0000E+00	1.0000E+00	0.0000E+00	0.0000E+00	0.0000E+00	-5.7633E-01	0.0000E+00	4.2367E-01	
entering				source	energy cutoff	time cutoff	exiting	total			
total			0.0000E+00	1.0000E+00	0.0000E+00	0.0000E+00	-5.7633E-01	0.0000E+00	4.2367E-01		
neutron weight balance in each cell -- variance reduction events											print table 130
cell	1	1	0.0000E+00	0.0000E+00	6.6914E-04	0.0000E+00	0.0000E+00	0.0000E+00	0.0000E+00	6.6914E-04	
weight window				cell importance	weight cutoff	energy importance	dxtran	forced collision	exponential transform	total	
total			0.0000E+00	0.0000E+00	6.6914E-04	0.0000E+00	0.0000E+00	0.0000E+00	0.0000E+00	6.6914E-04	
neutron weight balance in each cell -- physical events											print table 130
cell	1	1	5.5379E-03	0.0000E+00	-4.4700E-02	-2.7615E-03	-3.8242E-01	-4.2434E-01			
(n,xn)				fission	capture	loss to (n,xn)	loss to fission	total			
total			5.5379E-03	0.0000E+00	-4.4700E-02	-2.7615E-03	-3.8242E-01	-4.2434E-01			
neutron activity of each nuclide in each cell, per source particle											print table 140
cell	1	1	92235.61c	9.3916E-01	341484	2.4732E+00	4.2463E-02	3.7584E-01	2.6519E-03		
nuclides				atom fraction	total collisions	collisions * weight	weight lost to capture	weight lost to fission	weight gain by (n,xn)		
total			92235.61c	9.3916E-01	341484	2.4732E+00	4.2463E-02	3.7584E-01	2.6519E-03		
			92238.61c	5.0586E-02	18718	1.3668E-01	1.5079E-03	3.3677E-03	1.1715E-04		
			92234.61c	1.0250E-02	4037	2.9556E-02	7.2938E-04	3.2123E-03	7.3822E-06		
total					364239	2.6395E+00	4.4700E-02	3.8242E-01	2.7764E-03		
total over all cells for each nuclide											
			92234.61c		4037	2.9556E-02	7.2938E-04	3.2123E-03	7.3822E-06		
			92235.61c		341484	2.4732E+00	4.2463E-02	3.7584E-01	2.6519E-03		

92238.61c 18718 1.3668E-01 1.5079E-03 3.3677E-03 1.1715E-04  
 lkeff results for: bare u(94) sphere ref. la-4208, g. e. hansen and h. c. paxton, 1969, page 4 probid = 07/31/00 12:11:37

the initial fission neutron source distribution used the 1 source points that were input on the ksrc card.  
 the criticality problem was scheduled to skip 5 cycles and run a total of 35 cycles with nominally 3000 neutrons per cycle.  
 this problem has run 5 inactive cycles with 15332 neutron histories and 30 active cycles with 89903 neutron histories.

this calculation has completed the requested number of keff cycles using a total of 105235 fission neutron source histories.  
 all cells with fissionable material were sampled and had fission neutron source points.

the results of the w test for normality applied to the individual collision, absorption, and track-length keff cycle values are:

the k (collision) cycle values appear normally distributed at the 95 percent confidence level  
 the k(absorption) cycle values appear normally distributed at the 95 percent confidence level  
 the k(trk length) cycle values appear normally distributed at the 95 percent confidence level

**N21**

-----  
 | the final estimated combined collision/absorption/track-length keff = 0.99408 with an estimated standard deviation of 0.00220  
 | the estimated 68, 95, & 99 percent keff confidence intervals are 0.99185 to 0.99632, 0.98956 to 0.99861, and 0.98797 to 1.00019  
the final combined (col/abs/trk) prompt removal lifetime = 6.1875E-09 seconds with an estimated standard deviation of 2.3789E-11

the estimated average keffs, one standard deviations, and 68, 95, and 99 percent confidence intervals are:

keff estimator	keff	standard deviation	68% confidence	95% confidence	99% confidence	corr
collision	0.99365	0.00319	0.99042 to 0.99689	0.98712 to 1.00019	0.98485 to 1.00246	
absorption	0.99339	0.00321	0.99013 to 0.99664	0.98681 to 0.99996	0.98452 to 1.00225	
track length	0.99400	0.00219	0.99178 to 0.99622	0.98951 to 0.99849	0.98795 to 1.00005	
col/absorp	0.99367	0.00329	0.99034 to 0.99700	0.98694 to 1.00041	0.98459 to 1.00276	0.9947
abs/trk len	0.99421	0.00215	0.99203 to 0.99639	0.98980 to 0.99861	0.98826 to 1.00015	0.8387
col/trk len	0.99413	0.00214	0.99196 to 0.99630	0.98974 to 0.99851	0.98820 to 1.00005	0.8453
col/abs/trk len	0.99408	0.00220	0.99185 to 0.99632	0.98956 to 0.99861	0.98797 to 1.00019	

**N22**

if the largest of each keff occurred on the next cycle, the keff results and 68, 95, and 99 percent confidence intervals would be:

keff estimator	keff	standard deviation	68% confidence	95% confidence	99% confidence
keff estimator					
collision	0.99452	0.00321	0.99128 to 0.99777	0.98797 to 1.00108	0.98570 to 1.00335

absorption 0.99416 0.00320 0.99092 to 0.99741 0.98762 to 1.00071 0.98535 to 1.00298  
 track length 0.99476 0.00225 0.99248 to 0.99705 0.99016 to 0.99937 0.98856 to 1.00097  
 col/abs/trk len 0.99459 0.00226 0.99229 to 0.99688 0.98995 to 0.99921 0.98833 to 1.00081

**N23**

the estimated average prompt removal lifetimes, one standard deviations, and 68, 95, and 99 percent confidence intervals are (sec):

estimator	lifetime	std. dev.	68% confidence	95% confidence	99% confidence	corr
collision	6.19351E-09	2.66771E-11	6.1665E-09 to 6.2205E-09	6.1390E-09 to 6.2480E-09	6.1201E-09 to 6.2669E-09	
absorption	6.19586E-09	2.66582E-11	6.1689E-09 to 6.2228E-09	6.1414E-09 to 6.2503E-09	6.1226E-09 to 6.2692E-09	
track length	6.18776E-09	2.16289E-11	6.1659E-09 to 6.2096E-09	6.1436E-09 to 6.2319E-09	6.1283E-09 to 6.2472E-09	
col/absorp	6.19578E-09	2.94182E-11	6.1660E-09 to 6.2256E-09	6.1355E-09 to 6.2561E-09	6.1145E-09 to 6.2771E-09	0.9992
abs/trk len	6.18454E-09	2.16832E-11	6.1622E-09 to 6.2065E-09	6.1401E-09 to 6.2290E-09	6.1246E-09 to 6.2445E-09	0.9045
col/trk len	6.18542E-09	2.15725E-11	6.1636E-09 to 6.2073E-09	6.1412E-09 to 6.2296E-09	6.1258E-09 to 6.2450E-09	0.9056
col/abs/trk len	6.18747E-09	2.37889E-11	6.1634E-09 to 6.2116E-09	6.1387E-09 to 6.2362E-09	6.1217E-09 to 6.2532E-09	

absorption estimates of prompt lifetimes (sec):

	escape	capture	fission	removal
lifespan	6.04675E-09	1.01744E-08	5.95603E-09	6.19605E-09
fraction	5.74348E-01	4.45467E-02	3.81105E-01	1.00000E+00
lifetime(abs)	1.07876E-08	1.39087E-07	1.62576E-08	6.19586E-09
lifetime(c/a/t)	1.07730E-08	1.38899E-07	1.62356E-08	6.18747E-09

**N24**

=====

= the following output gives the predicted changes in keff (track length estimator) for the perturbations.

= the differential operator method was used to obtain these results (1st and/or 2nd order).

= warning: fundamental eigenvector (fission distribution) approximated as unperturbed.

=====

perturbation k(trk ln) std. dev.  
 1 1.04614 0.00234

laverage keff results summed over 2 cycles each to form 15 batch values of keff print table 178

**N25**

batch number	start cycle	end cycle	keff estimators by batch	average keff estimators and deviations	col/abs/tl keff
number	cycle	cycle	k(coll) k(abs) k(track)	k(coll) st dev k(abs) st dev k(track) st dev	k(c/a/t) st dev
1	6	7	1.00212 1.00015 0.99691		
2	8	9	0.98160 0.98329 0.98029	0.99186 0.01026 0.99172 0.00843 0.98860 0.00831	
3	10	11	0.99780 0.99946 1.00115	0.99384 0.00624 0.99430 0.00551 0.99278 0.00637	
4	12	13	0.98606 0.98403 0.99690	0.99190 0.00483 0.99173 0.00466 0.99381 0.00462	0.99291 0.00744
5	14	15	0.98197 0.98098 0.99300	0.98991 0.00423 0.98958 0.00420 0.99365 0.00358	0.99255 0.00536





number	cycle	cycle	k(coll)	k(abs)	k(track)	k(coll)	st dev	k(abs)	st dev	k(track)	st dev	k(c/a/t)	st dev
1	6	11	0.99384	0.99430	0.99278								
2	12	17	0.98779	0.98687	0.99586	0.99081	0.00303	0.99058	0.00372	0.99432	0.00154		
3	18	23	0.99767	0.99770	0.99774	0.99310	0.00288	0.99295	0.00320	0.99546	0.00144		
4	24	29	0.99008	0.98894	0.98993	0.99235	0.00217	0.99195	0.00247	0.99408	0.00172	0.99430	0.00243
5	30	35	0.99889	0.99912	0.99371	0.99365	0.00213	0.99339	0.00239	0.99400	0.00133	0.99469	0.00150

average keff results summed over 10 cycles each to form 3 batch values of keff

batch number	start cycle	end cycle	k(coll)	k(abs)	k(track)	k(coll)	st dev	k(abs)	st dev	k(track)	st dev
1	6	15	0.98991	0.98958	0.99365						
2	16	25	0.99786	0.99739	0.99683	0.99389	0.00398	0.99348	0.00390	0.99524	0.00159
3	26	35	0.99318	0.99319	0.99153	0.99365	0.00231	0.99339	0.00226	0.99400	0.00154

average keff results summed over 15 cycles each to form 2 batch values of keff

batch number	start cycle	end cycle	k(coll)	k(abs)	k(track)	k(coll)	st dev	k(abs)	st dev	k(track)	st dev
1	6	20	0.99181	0.99177	0.99479						
2	21	35	0.99550	0.99500	0.99322	0.99365	0.00184	0.99339	0.00162	0.99400	0.00079

laverage individual and combined collision/absorption/track-length keff results for 5 different batch sizes

**N26**

cycles per keff batch	number of k batches	average k(col)	st dev	k(abs)	st dev	k(trk)	st dev	normality co/ab/trk	average k(c/a/t)	st dev	95% confidence	99% confidence
1	30	0.9937	0.0032	0.9934	0.0032	0.9940	0.0022	95/95/95	0.99408	0.00220	0.98956-0.99861	0.98797-1.00019
2	15	0.9937	0.0027	0.9934	0.0027	0.9940	0.0017	95/95/95	0.99396	0.00184	0.98995-0.99797	0.98834-0.99958
3	10	0.9937	0.0027	0.9934	0.0028	0.9940	0.0014	95/95/95	0.99400	0.00151	0.99042-0.99758	0.98871-0.99930
5	6	0.9937	0.0023	0.9934	0.0025	0.9940	0.0010	95/95/95	0.99397	0.00141	0.98949-0.99844	0.98575-1.00218
6	5	0.9937	0.0021	0.9934	0.0024	0.9940	0.0013	95/95/95	0.99469	0.00150	0.98823-1.00116	0.97979-1.00960

lindividual and average keff estimator results by cycle

**N27**

keff cycle	neutron histories	k(coll)	k(abs)	k(track)	average k(coll)	st dev	k(abs)	st dev	k(track)	st dev	average k(c/a/t)	st dev	fom
1	3000	1.35813	1.35567	1.34299									
2	4119	1.15406	1.15263	1.14618									
3	2562	1.06451	1.06650	1.06327									
4	2784	1.02132	1.02362	1.01860									
5	2867	1.02371	1.02286	1.03020									

cycle number	active cycles	begin active keff	cycles	begin active keff	cycles	begin active keff	cycles	begin active keff	cycles
6	2971	0.98661	0.98343	0.99348					
7	2887	1.01763	1.01686	1.00035					
8	3110	0.98467	0.98572	0.99327					
9	2891	0.97854	0.98087	0.96731					19883
10	3042	1.01102	1.01427	1.01223					14421
11	3073	0.98457	0.98465	0.99008					
12	2925	0.95715	0.95549	0.97617					21812
13	2886	1.01497	1.01256	1.01762					23358
14	3148	0.96430	0.96165	0.98053					20390
15	2812	0.99964	1.00031	1.00547					21229
16	3090	1.01165	1.01124	1.00505					22558
17	3078	0.97902	0.97995	0.99031					26204
18	2831	1.00428	1.00388	1.00553					28459
19	3049	0.97510	0.97467	0.98579					30555
20	2899	1.00799	1.01099	0.99867					31745
21	3105	0.98962	0.99153	0.99335					36437
22	2974	1.00901	1.00760	1.00932					
23	3073	1.00001	0.99752	0.99377					
24	2971	1.02064	1.01748	1.01019					
25	2976	0.98132	0.97900	0.97634					
26	2917	0.99309	0.99212	0.99382					
27	3084	0.99086	0.99172	0.99193					
28	3002	0.98990	0.98813	0.99055					
29	3123	0.96469	0.96520	0.97671					
30	2908	1.01006	1.00794	0.99760					
31	3169	0.99172	0.99324	0.99247					
32	2839	0.96936	0.97006	0.98392					
33	2919	0.99556	0.99462	0.98321					
34	3078	1.01230	1.01367	1.00685					
35	3073	1.01431	1.01522	0.99820					

**N28**

the largest active cycle keffs by estimator are:

collision 1.02064	on cycle 24
absorption 1.01748	on cycle 24
track length 1.01762	on cycle 13

lplot of the estimated col/abs/track-length keff one standard deviation interval versus cycle number (| = final keff = 0.99408)

cycle number	active 0.98	0.99	1.00	1.01
11	----- ----- ----- ----- -----			
12	(-----k----- ----- ----- ----- )			
13	(-----k----- ----- ----- ----- )			

the smallest active cycle keffs by estimator are:

collision 0.95715	on cycle 12
absorption 0.95549	on cycle 12
track length 0.96731	on cycle 9

lplot of the estimated col/abs/track-length keff one standard deviation interval versus cycle number (| = final keff = 0.99408)

cycle number	active 0.98	0.99	1.00	1.01
11	----- ----- ----- ----- -----			
12	(-----k----- ----- ----- ----- )			
13	(-----k----- ----- ----- ----- )			



19	16	48110	0.9963	0.0040	0.9960	0.0039	0.9936	0.0025	95/95/95	0.99226	0.00262	0.98661-0.99791	0.98438-1.00014
20	15	45211	0.9955	0.0042	0.9950	0.0040	0.9932	0.0027	95/95/95	0.99223	0.00282	0.98608-0.99837	0.98361-1.00084
21	14	42106	0.9959	0.0044	0.9953	0.0043	0.9932	0.0029	95/95/95	0.99193	0.00317	0.98496-0.99891	0.98209-1.00178
22	13	39132	0.9949	0.0047	0.9943	0.0046	0.9920	0.0028	95/95/95	0.99066	0.00289	0.98422-0.99711	0.98149-0.99983
23	12	36059	0.9945	0.0051	0.9940	0.0050	0.9918	0.0031	95/95/95	0.99059	0.00308	0.98361-0.99757	0.98057-1.00061
24	11	33088	0.9921	0.0049	0.9919	0.0049	0.9901	0.0028	95/95/95	0.98968	0.00250	0.98392-0.99544	0.98130-0.99805
25	10	30112	0.9932	0.0053	0.9932	0.0052	0.9915	0.0027	95/95/95	0.99061	0.00244	0.98483-0.99639	0.98206-0.99916
26	9	27195	0.9932	0.0059	0.9933	0.0059	0.9913	0.0030	95/95/95	0.98990	0.00269	0.98331-0.99649	0.97991-0.99989
27	8	24111	0.9935	0.0067	0.9935	0.0066	0.9912	0.0034	95/95/95	0.98981	0.00312	0.98179-0.99782	0.97723-1.00238
28	7	21109	0.9940	0.0077	0.9943	0.0076	0.9913	0.0040	95/95/95	0.98855	0.00371	0.97826-0.99885	0.97148-1.00562
29	6	17986	0.9989	0.0070	0.9991	0.0069	0.9937	0.0037	95/95/95	0.99051	0.00465	0.97572-1.00531	0.96336-1.01766
30	5	15078	0.9967	0.0081	0.9974	0.0082	0.9929	0.0045	95/95/95	0.98499	0.00423	0.96680-1.00318	0.94304-1.02694
31	4	11909	0.9979	0.0104	0.9984	0.0105	0.9930	0.0058	95/95/95	0.98556	0.00438	0.92987-1.04126	0.70661-1.26452
32	3	9070	1.0074	0.0059	1.0078	0.0066	0.9961	0.0069					
33	2	6151	1.0133	0.0010	1.0144	0.0008	1.0025	0.0043					

**N31**

the minimum estimated standard deviation for the col/abs/trk keff estimator occurs with 4 inactive cycles and 31 active cycles.

**N32**

the first active half of the problem skips 5 cycles and uses 15 active cycles; the second half skips 20 and uses 15 cycles. the col/abs/trk-len keff, one standard deviation, and 68, 95, and 99 percent intervals for each active half of the problem are:

problem	keff	standard deviation	68% confidence	95% confidence	99% confidence
first half	0.99594	0.00387	0.99192 to 0.99995	0.98751 to 1.00437	0.98412 to 1.00776
second half	0.99223	0.00282	0.98930 to 0.99515	0.98608 to 0.99837	0.98361 to 1.00084
final result	0.99408	0.00220	0.99185 to 0.99632	0.98956 to 0.99861	0.98797 to 1.00019

the first and second half values of k(collison/absorption/track length) appear to be the same at the 68 percent confidence level. lplot of the estimated col/abs/track-length keff one standard deviation interval by active cycle number (| = final keff = 0.99408)

**N33**

inactive cycles	active cycles	0.98	0.99	1.00	1.01	1.02	1.03
0	35						
1	34						
2	33						
3	32						
4	31						
5	30						
6	29						
7	28						
8	27						
9	26						
10	25						
11	24						

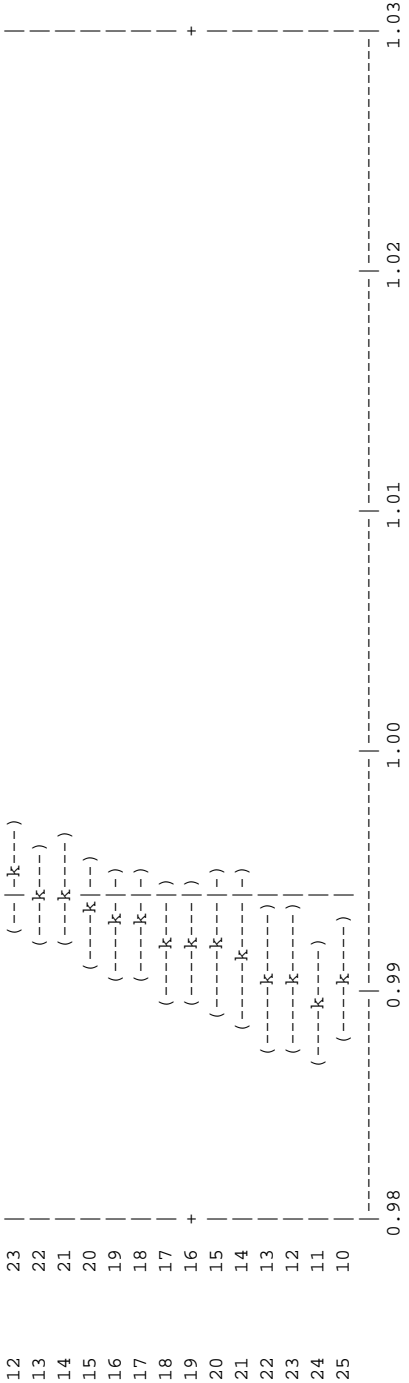

**N34** ltally 1 nps = 105235  
 tally type 1 number of particles crossing a surface.  
 tally for neutrons  
 number of histories used for normalizing tallies = 90000.00

surface 1	energy	count
1.0000E-07	0.00000E+00	0.0000
4.0000E-07	0.00000E+00	0.0000
1.0000E-06	0.00000E+00	0.0000
3.0000E-06	0.00000E+00	0.0000
1.0000E-05	0.00000E+00	0.0000
3.0000E-05	0.00000E+00	0.0000
1.0000E-04	0.00000E+00	0.0000
5.5000E-04	0.00000E+00	0.0000
3.0000E-03	1.93456E-05	0.5056
1.7000E-02	5.56838E-04	0.1069
1.0000E-01	1.43341E-02	0.0202
4.0000E-01	9.50148E-02	0.0077
9.0000E-01	1.41255E-01	0.0067
1.4000E+00	9.03271E-02	0.0093
3.0000E+00	1.44701E-01	0.0073
2.0000E+01	9.01202E-02	0.0097
total	5.76327E-01	0.0019

lanalysis of the results in the tally fluctuation chart bin (tfc) for tally 1 with nps = 105235 print table 160

normed average tally per history	= 5.76327E-01	unnormed average tally per history	= 5.76327E-01
estimated tally relative error	= 0.0019	estimated variance of the variance	= 0.0000
relative error from zero tallies	= 0.0014	relative error from nonzero scores	= 0.0013
number of nonzero history tallies	= 77248	efficiency for the nonzero tallies	= 0.8583
history number of largest tally	= 27863	largest unnormalized history tally	= 1.69041E+00

(largest tally)/(average tally) = 2.93307E+00 (largest tally)/(avg nonzero tally)= 2.51749E+00  
 (confidence interval shift)/mean = 0.0000 shifted confidence interval center = 5.76327E-01

if the largest history score sampled so far were to occur on the next history, the tfc bin quantities would change as follows:  
 nps = 89903 for this table because 5 keff cycles and 15332 histories were skipped before tally accumulation.

estimated quantities	value at nps	value at nps+1	value(nps+1)/value(nps)-1.
mean	5.76327E-01	5.76340E-01	0.000022
relative error	1.86279E-03	1.85963E-03	-0.001695
variance of the variance	1.30178E-05	1.30942E-05	0.005862
shifted center	5.76327E-01	5.76327E-01	0.000000
figure of merit	7.93646E+04	7.96343E+04	0.003399

the estimated slope of the 70 largest tallies starting at 1.06982E+00 appears to be decreasing at least exponentially.  
 the empirical history score probability density function appears to be increasing at the largest history scores: please examine.  
 the large score tail of the empirical history score probability density function appears to have no unsampled regions.

=====

results of 10 statistical checks for the estimated answer for the tally fluctuation chart (tfc) bin of tally 1

tfc bin	--mean-- behavior	-----relative error----- value	decrease	rate	----variance of the variance---- value	decrease	rate	--figure of merit-- value	behavior	-pdf- slope
desired	random	<0.10	yes	1/sqrt(nps)	<0.10	yes	1/nps	constant	random	>3.00
observed	random	0.00	yes	yes	0.00	yes	yes	constant	random	10.00
passed?	yes	yes	yes	yes	yes	yes	yes	yes	yes	yes

=====

this tally meets the statistical criteria used to form confidence intervals: check the tally fluctuation chart to verify.  
 the results in other bins associated with this tally may not meet these statistical criteria.

estimated asymmetric confidence interval(1,2,3 sigma): 5.7525E-01 to 5.7740E-01; 5.7418E-01 to 5.7847E-01; 5.7311E-01 to 5.7955E-01  
 estimated symmetric confidence interval(1,2,3 sigma): 5.7525E-01 to 5.7740E-01; 5.7418E-01 to 5.7847E-01; 5.7311E-01 to 5.7955E-01

fom = (histories/minute)\*(f(x) signal-to-noise ratio)\*\*2 = (2.479E+04)\*( 1.789E+00)\*\*2 = (2.479E+04)\*(3.202E+00) = 7.936E+04  
 SKIP 49 LINES IN OUTPUT

**N35** tally 6 nps = 105235 units mev/gram  
 tally type 6 track length estimate of heating.  
 tally for neutrons  
 number of histories used for normalizing tallies = 90000.00

```

masses          cell:          1
                    5.17571E+04

cell 1
energy
1.0000E-07      0.00000E+00  0.0000
4.0000E-07      0.00000E+00  0.0000
1.0000E-06      0.00000E+00  0.0000
3.0000E-06      0.00000E+00  0.0000
1.0000E-05      0.00000E+00  0.0000
3.0000E-05      0.00000E+00  0.0000
1.0000E-04      4.21331E-08  1.0000
5.5000E-04      7.99328E-08  0.5976
3.0000E-03      5.02019E-07  0.2414
1.7000E-02      4.40209E-06  0.0678
1.0000E-01      6.29932E-05  0.0168
4.0000E-01      2.56615E-04  0.0071
9.0000E-01      2.77559E-04  0.0060
1.4000E+00      1.74875E-04  0.0079
3.0000E+00      3.00692E-04  0.0058
2.0000E+01      1.69072E-04  0.0081
total           1.24683E-03  0.0020

lanalysis of the results in the tally fluctuation chart bin (tfc) for tally 6 with nps = 105235 print table 160

normed average tally per history = 1.24683E-03      unnormed average tally per history = 6.45325E+01
estimated tally relative error = 0.0020             estimated variance of the variance = 0.0000
relative error from zero tallies = 0.0001           relative error from nonzero scores = 0.0020

number of nonzero history tallies = 89903           efficiency for the nonzero tallies = 0.9989
history number of largest tally = 101153            largest unnormalized history tally = 3.31676E+02
(largest tally)/(average tally) = 5.13968E+00       (largest tally)/(avg nonzero tally)= 5.13414E+00

(confidence interval shift)/mean = 0.0000           shifted confidence interval center = 1.24684E-03

if the largest history score sampled so far were to occur on the next history, the tfc bin quantities would change as follows:
nps = 89903 for this table because 5 keff cycles and 15332 histories were skipped before tally accumulation.

estimated quantities      value at nps      value at nps+1      value(nps+1)/value(nps)-1.
mean                      1.24683E-03      1.24689E-03      0.000046
relative error            1.99134E-03      1.98875E-03      -0.001303
variance of the variance  3.81875E-05      3.85391E-05      0.009208
shifted center           1.24684E-03      1.24684E-03      0.000000
figure of merit           6.94483E+04      6.96296E+04      0.002611

```

the estimated slope of the 198 largest tallies starting at 2.21201E+02 appears to be decreasing at least exponentially. the large score tail of the empirical history score probability density function appears to have no unsampled regions.

```

=====
results of 10 statistical checks for the estimated answer for the tally fluctuation chart (tfc) bin of tally 6
=====
tfc bin      --mean--      -----relative error-----      ----variance of the variance----      --figure of merit--      -pdf-
behavior      value      decrease      rate      value      decrease      rate      value      behavior      slope
desired      random      <0.10      yes      1/sqrt(nps)      <0.10      yes      1/nps      constant      random      >3.00
observed      random      0.00      yes      yes      0.00      yes      yes      constant      random      10.00
passed?      yes      yes      yes      yes      yes      yes      yes      yes      yes      yes
=====

```

this tally meets the statistical criteria used to form confidence intervals: check the tally fluctuation chart to verify. the results in other bins associated with this tally may not meet these statistical criteria.

```

estimated asymmetric confidence interval(1,2,3 sigma): 1.2444E-03 to 1.2493E-03; 1.2419E-03 to 1.2518E-03; 1.2394E-03 to 1.2543E-03
estimated symmetric confidence interval(1,2,3 sigma): 1.2444E-03 to 1.2493E-03; 1.2419E-03 to 1.2518E-03; 1.2394E-03 to 1.2543E-03

```

$$fom = (\text{histories/minute}) * (f(x) \text{ signal-to-noise ratio}) ** 2 = (2.479E+04) * (1.674E+00) ** 2 = (2.479E+04) * (2.802E+00) = 6.945E+04$$

SKIP TABLES 161 AND 162 IN OUTPUT

**N36** tally 7 nps = 105235

tally type 7 track length estimate of fission heating. units mev/gram

number of histories used for normalizing tallies = 90000.00

masses

cell: 1  
5.17571E+04

```

cell 1
energy
1.0000E-07 0.00000E+00 0.0000
4.0000E-07 0.00000E+00 0.0000
1.0000E-06 0.00000E+00 0.0000
3.0000E-06 0.00000E+00 0.0000
1.0000E-05 0.00000E+00 0.0000
3.0000E-05 0.00000E+00 0.0000
1.0000E-04 4.50318E-08 1.0000
5.5000E-04 8.55183E-08 0.5978
3.0000E-03 5.36601E-07 0.2413
1.7000E-02 4.70495E-06 0.0678

```



```

1.0000E-01 6.72758E-05 0.0168
4.0000E-01 2.74136E-04 0.0071
9.0000E-01 2.96092E-04 0.0060
1.4000E+00 1.87357E-04 0.0079
3.0000E+00 3.23609E-04 0.0058
2.0000E+01 1.83378E-04 0.0081
total 1.33722E-03 0.0020
lanalysis of the results in the tally fluctuation chart bin (tfc) for tally 7 with nps = 105235 print table 160

```

```

normed average tally per history = 1.33722E-03 unnormed average tally per history = 6.92107E+01
estimated tally relative error = 0.0020 estimated variance of the variance = 0.0000
relative error from zero tallies = 0.0001 relative error from nonzero scores = 0.0020

number of nonzero history tallies = 89903 efficiency for the nonzero tallies = 0.9989
history number of largest tally = 101153 largest unnormalized history tally = 3.54596E+02
(largest tally)/(average tally) = 5.12343E+00 (largest tally)/(avg nonzero tally)= 5.11791E+00

(confidence interval shift)/mean = 0.0000 shifted confidence interval center = 1.33722E-03

```

if the largest history score sampled so far were to occur on the next history, the tfc bin quantities would change as follows:  
nps = 89903 for this table because 5 keff cycles and 15332 histories were skipped before tally accumulation.

```

estimated quantities value at nps value at nps+1 value (nps+1)/(value(nps)-1.
mean 1.33722E-03 1.33728E-03 0.000046
relative error 1.98857E-03 1.98597E-03 -0.001308
variance of the variance 3.80138E-05 3.83625E-05 0.009174
shifted center 1.33722E-03 1.33722E-03 0.000000
figure of merit 6.96421E+04 6.98246E+04 0.002621

```

the estimated slope of the 200 largest tallies starting at 2.36318E+02 appears to be decreasing at least exponentially.  
the large score tail of the empirical history score probability density function appears to have no unsampled regions.

```

=====
results of 10 statistical checks for the estimated answer for the tally fluctuation chart (tfc) bin of tally 7
tfc bin --mean-- -----relative error----- ----variance of the variance---- --figure of merit-- -pdf-
behavior behavior value decrease rate value decrease rate value decrease rate value behavior behavior slope
desired random <0.10 yes 1/sqrt(nps) <0.10 yes 1/nps constant random >3.00
observed random 0.00 yes yes 0.00 yes yes constant random 10.00
passed? yes yes yes yes yes yes yes yes yes yes
=====

```

this tally meets the statistical criteria used to form confidence intervals: check the tally fluctuation chart to verify. the results in other bins associated with this tally may not meet these statistical criteria.

estimated asymmetric confidence interval(1,2,3 sigma): 1.3346E-03 to 1.3399E-03; 1.3319E-03 to 1.3425E-03; 1.3292E-03 to 1.3452E-03  
 estimated symmetric confidence interval(1,2,3 sigma): 1.3346E-03 to 1.3399E-03; 1.3319E-03 to 1.3425E-03; 1.3292E-03 to 1.3452E-03

fom = (histories/minute)\*(f(x) signal-to-noise ratio)\*\*2 = (2.479E+04)\*( 1.676E+00)\*\*2 = (2.479E+04)\*(2.810E+00) = 6.964E+04

SKIP TABLES 161 AND 162 IN OUTPUT

**N37** ltally 14 nps = 105235

total total fission neutrons (track-length Keff), total loss to (n,xn)  
 total neutron absorptions,total fission,and neutron heating (mev/gram)  
 tally type 4 track length estimate of particle flux.

number of histories used for normalizing tallies = 90000.00

multiplier bin 1:	1.32534E+02	10	-6	-7
multiplier bin 2:	1.32534E+02	10	16	17
multiplier bin 3:	1.32534E+02	10	-2	
multiplier bin 4:	1.32534E+02	10	-6	
multiplier bin 5:	2.56069E-03	10	1	-4

volumes

cell: 1  
 2.76185E+03

cell	1	2	3	4	5
mult bin:	1	2	3	4	5
energy	0.0000E+00	0.0000E+00	0.0000E+00	0.0000E+00	0.0000E+00
1.0000E-07	0.0000E+00	0.0000E+00	0.0000E+00	0.0000E+00	0.0000E+00
4.0000E-07	0.0000E+00	0.0000E+00	0.0000E+00	0.0000E+00	0.0000E+00
1.0000E-06	0.0000E+00	0.0000E+00	0.0000E+00	0.0000E+00	0.0000E+00
3.0000E-06	0.0000E+00	0.0000E+00	0.0000E+00	0.0000E+00	0.0000E+00
1.0000E-05	0.0000E+00	0.0000E+00	0.0000E+00	0.0000E+00	0.0000E+00
3.0000E-05	0.0000E+00	0.0000E+00	0.0000E+00	0.0000E+00	0.0000E+00
1.0000E-04	3.13391E-05	1.0000	9.43974E-06	1.0000	4.21354E-08
5.5000E-04	5.95150E-05	0.5978	8.30220E-06	0.6257	7.99372E-08
3.0000E-03	3.73438E-04	0.2413	7.82420E-05	0.2413	5.02047E-07
1.7000E-02	3.27337E-03	0.0678	4.94682E-04	0.0675	4.40234E-06
1.0000E-01	4.67088E-02	0.0168	6.04415E-03	0.0170	6.229967E-05
4.0000E-01	1.92544E-01	0.0071	1.67116E-02	0.0073	2.56629E-04
9.0000E-01	2.11200E-01	0.0060	1.14261E-02	0.0061	2.77575E-04
1.4000E+00	1.36490E-01	0.0079	4.89812E-03	0.0079	1.74885E-04
3.0000E+00	2.45846E-01	0.0058	4.47338E-03	0.0061	3.00709E-04
2.0000E+01	1.57533E-01	0.0082	5.58023E-04	0.0095	1.69082E-04
total	9.94059E-01	0.0020	4.47020E-02	0.0037	1.24690E-03

lanalysis of the results in the tally fluctuation chart bin (tfc) for tally 14 with nps = 105235 print table 160

```

normed average tally per history = 9.94059E-01      unnormed average tally per history = 2.74544E+03
estimated tally relative error   = 0.0020          estimated variance of the variance = 0.0000
relative error from zero tallies = 0.0001         relative error from nonzero scores = 0.0020

number of nonzero history tallies = 89903          efficiency for the nonzero tallies = 0.9989
history number of largest tally   = 84240         largest unnormalized history tally = 1.58138E+04
(largest tally)/(average tally) = 5.76003E+00     (largest tally)/(avg nonzero tally)= 5.75382E+00

(confidence interval shift)/mean = 0.0000        shifted confidence interval center = 9.94062E-01

```

if the largest history score sampled so far were to occur on the next history, the tfc bin quantities would change as follows:  
nps = 89903 for this table because 5 keff cycles and 15332 histories were skipped before tally accumulation.

estimated quantities	value at nps	value at nps+1	value(nps+1)/value(nps)-1.
mean	9.94059E-01	9.94112E-01	0.000053
relative error	1.97345E-03	1.97099E-03	-0.001245
variance of the variance	3.80437E-05	3.86107E-05	0.014903
shifted center	9.94062E-01	9.94062E-01	0.000000
figure of merit	7.07134E+04	7.08898E+04	0.002494

the estimated slope of the 200 largest tallies starting at 9.32151E+03 appears to be decreasing at least exponentially.  
the large score tail of the empirical history score probability density function appears to have no unsampled regions.

```

=====
results of 10 statistical checks for the estimated answer for the tally fluctuation chart (tfc) bin of tally 14
=====
tfc bin  --mean--  -----relative error-----  ----variance of the variance----  --figure of merit--  -pdf-
behavior  behavior  value decrease rate  value decrease rate  value decrease rate  value behavior  slope
desired  random  <0.10  yes  1/sqrt(nps)  <0.10  yes  1/nps  constant  random  >3.00
observed  random  0.00  yes  yes  0.00  yes  yes  constant  random  10.00
passed?   yes  yes  yes  yes  yes  yes  yes  yes  yes  yes  yes
=====

```

this tally meets the statistical criteria used to form confidence intervals: check the tally fluctuation chart to verify.  
the results in other bins associated with this tally may not meet these statistical criteria.

estimated asymmetric confidence interval(1,2,3 sigma): 9.9210E-01 to 9.9602E-01; 9.9014E-01 to 9.9799E-01; 9.8818E-01 to 9.9995E-01  
estimated symmetric confidence interval(1,2,3 sigma): 9.9210E-01 to 9.9602E-01; 9.9014E-01 to 9.9799E-01; 9.8817E-01 to 9.9994E-01

fom = (histories/minute)\*(f(x) signal-to-noise ratio)\*\*2 = (2.479E+04)\*( 1.689E+00)\*\*2 = (2.479E+04)\*(2.853E+00) = 7.071E+04  
 SKIP TABLES 161 AND 162 IN OUTPUT

**N38** ltally 34 nps = 105235

tally type 4 track length estimate of particle flux.

tally for neutrons

number of histories used for normalizing tallies = 90000.00

multiplier bin 1: -1.00000E+00 10 -6 -7  
 multiplier bin 2: -1.00000E+00 10 16 : 17  
 multiplier bin 3: -1.00000E+00 10 -2  
 multiplier bin 4: -1.00000E+00 10 -6  
 multiplier bin 5: -1.93210E-05 10 1 -4

volumes

cell: 1  
 1.00000E+00

energy bin: 0. to 2.00000E+01

cell: 1

mult bin  
 1 9.94003E-01 0.0020  
 2 2.64767E-03 0.0239  
 3 4.46995E-02 0.0037  
 4 3.82651E-01 0.0020  
 5 1.24683E-03 0.0020

lanalysis of the results in the tally fluctuation chart bin (tfc) for tally 34 with nps = 105235 print table 160

normed average tally per history = 9.94003E-01 unnormed average tally per history = 9.94003E-01  
 estimated tally relative error = 0.0020 estimated variance of the variance = 0.0000  
 relative error from zero tallies = 0.0001 relative error from nonzero scores = 0.0020

number of nonzero history tallies = 89903 efficiency for the nonzero tallies = 0.9989  
 history number of largest tally = 84240 largest unnormalized history tally = 5.72548E+00  
 (largest tally)/(average tally) = 5.76003E+00 (largest tally)/(avg nonzero tally) = 5.75382E+00

(confidence interval shift)/mean = 0.0000 shifted confidence interval center = 9.94006E-01

if the largest history score sampled so far were to occur on the next history, the tfc bin quantities would change as follows:  
 nps = 89903 for this table because 5 keff cycles and 15332 histories were skipped before tally accumulation.

estimated quantities	value at nps	value at nps+1	value(nps+1)/value(nps)-1.
mean	9.94003E-01	9.94055E-01	0.000053
relative error	1.97345E-03	1.97099E-03	-0.001245
variance of the variance	3.80437E-05	3.86107E-05	0.014903
shifted center	9.94006E-01	9.94006E-01	0.000000
figure of merit	7.07134E+04	7.08898E+04	0.002494

the estimated slope of the 200 largest tallies starting at 3.37490E+00 appears to be decreasing at least exponentially. the large score tail of the empirical history score probability density function appears to have no unsampled regions.

```

=====
results of 10 statistical checks for the estimated answer for the tally fluctuation chart (tfc) bin of tally 34
=====
tfc bin  --mean--  -----relative error-----  ----variance of the variance----  --figure of merit--  -pdf-
behavior  behavior  value  decrease  rate  value  decrease  rate  value  behavior  slope
desired  random  <0.10  yes  1/sqrt(nps)  <0.10  yes  1/nps  constant  random  >3.00
observed  random  0.00  yes  yes  0.00  yes  yes  constant  random  10.00
passed?   yes  yes  yes  yes  yes  yes  yes  yes  yes  yes  yes
=====

```

this tally meets the statistical criteria used to form confidence intervals: check the tally fluctuation chart to verify. the results in other bins associated with this tally may not meet these statistical criteria.

```

estimated asymmetric confidence interval(1,2,3 sigma): 9.9204E-01 to 9.9597E-01; 9.9008E-01 to 9.9793E-01; 9.8812E-01 to 9.9989E-01
estimated symmetric confidence interval(1,2,3 sigma): 9.9204E-01 to 9.9596E-01; 9.9008E-01 to 9.9793E-01; 9.8812E-01 to 9.9989E-01
fom = (histories/minute)*(f(x) signal-to-noise ratio)**2 = (2.479E+04)*( 1.689E+00)**2 = (2.479E+04)*(2.853E+00) = 7.071E+04
SKIP TABLES 161 AND 162 IN OUTPUT
=====

```

= N39 =

= the following output gives the predicted change in a tally for perturbation 1.  
 = the differential operator method was used to obtain these results (1st and/or 2nd order).  
 =

**N40**

```

=====
ltally 1 nps = 105235
tally type 1 number of particles crossing a surface.
tally for neutrons
number of histories used for normalizing tallies = 90000.00

surface 1
energy
1.0000E-07 0.00000E+00 0.0000
4.0000E-07 0.00000E+00 0.0000
1.0000E-06 0.00000E+00 0.0000
3.0000E-06 0.00000E+00 0.0000
1.0000E-05 0.00000E+00 0.0000
3.0000E-05 0.00000E+00 0.0000
=====

```

```

1.0000E-04 0.0000E+00 0.0000
5.5000E-04 0.0000E+00 0.0000
3.0000E-03 1.65701E-05 0.5047
1.7000E-02 5.53326E-04 0.1064
1.0000E-01 1.40325E-02 0.0202
4.0000E-01 9.27035E-02 0.0076
9.0000E-01 1.36687E-01 0.0066
1.4000E+00 8.63582E-02 0.0092
3.0000E+00 1.37120E-01 0.0073
2.0000E+01 8.55312E-02 0.0096
total 5.53003E-01 0.0018
SKIP 102 LINES IN OUTPUT
ltally 6 nps = 105235
tally type 6 track length estimate of heating. units mev/gram
tally for neutrons
number of histories used for normalizing tallies = 90000.00
masses
cell: 1
5.17571E+04

```

```

cell 1
energy
1.0000E-07 0.0000E+00 0.0000
4.0000E-07 0.0000E+00 0.0000
1.0000E-06 0.0000E+00 0.0000
3.0000E-06 0.0000E+00 0.0000
1.0000E-05 0.0000E+00 0.0000
3.0000E-05 0.0000E+00 0.0000
1.0000E-04 3.78522E-08 1.0000
5.5000E-04 7.88833E-08 0.5905
3.0000E-03 4.77198E-07 0.2340
1.7000E-02 4.49400E-06 0.0661
1.0000E-01 6.37347E-05 0.0165
4.0000E-01 2.58753E-04 0.0069
9.0000E-01 2.75932E-04 0.0059
1.4000E+00 1.71299E-04 0.0077
3.0000E+00 2.91938E-04 0.0057
2.0000E+01 1.63937E-04 0.0079
total 1.23068E-03 0.0019
SKIP 214 LINES IN OUTPUT
ltally 7 nps = 105235
tally type 7 track length estimate of fission heating. units mev/gram
tally for neutrons
number of histories used for normalizing tallies = 90000.00
masses
cell: 1
5.17571E+04

```

```

cell 1
energy
1.0000E-07 0.00000E+00 0.0000
4.0000E-07 0.00000E+00 0.0000
1.0000E-06 0.00000E+00 0.0000
3.0000E-06 0.00000E+00 0.0000
1.0000E-05 0.00000E+00 0.0000
3.0000E-05 0.00000E+00 0.0000
1.0000E-04 4.04563E-08 1.0000
5.5000E-04 8.43930E-08 0.5907
3.0000E-03 5.10073E-07 0.2340
1.7000E-02 4.80318E-06 0.0661
1.0000E-01 6.80677E-05 0.0165
4.0000E-01 2.76420E-04 0.0069
9.0000E-01 2.94357E-04 0.0059
1.4000E+00 1.83525E-04 0.0077
3.0000E+00 3.14188E-04 0.0057
2.0000E+01 1.77808E-04 0.0079
total 1.31980E-03 0.0019

SKIP 217 LINES IN OUTPUT
N41 tally 14 nps = 105235
+
total total fission neutrons (track-length Keff), total loss to (n,xn)
total neutron absorptions, total fission, and neutron heating (mev/gram)
tally type 4 track length estimate of particle flux.
tally for neutrons
number of histories used for normalizing tallies = 90000.00
multiplier bin 1: 1.32534E+02 10 -6 -7
multiplier bin 2: 1.32534E+02 10 16 : 17
multiplier bin 3: 1.32534E+02 10 -2
multiplier bin 4: 1.32534E+02 10 -6
multiplier bin 5: 2.56069E-03 10 1 -4

volumes
cell: 1
2.76185E+03

cell 1
mult bin: 1 2 3 4 5
energy
1.0000E-07 0.00000E+00 0.0000 0.00000E+00 0.0000 0.00000E+00 0.0000
4.0000E-07 0.00000E+00 0.0000 0.00000E+00 0.0000 0.00000E+00 0.0000
1.0000E-06 0.00000E+00 0.0000 0.00000E+00 0.0000 0.00000E+00 0.0000
3.0000E-06 0.00000E+00 0.0000 0.00000E+00 0.0000 0.00000E+00 0.0000
1.0000E-05 0.00000E+00 0.0000 0.00000E+00 0.0000 0.00000E+00 0.0000
3.0000E-05 0.00000E+00 0.0000 0.00000E+00 0.0000 0.00000E+00 0.0000
1.0000E-04 2.81549E-05 1.0000 1.15769E-05 1.0000 3.78543E-08 1.0000
5.5000E-04 5.87319E-05 0.5907 2.41496E-05 0.5907 7.88876E-08 0.5905
3.0000E-03 3.54977E-04 0.2340 0.00000E+00 0.0000 7.44051E-05 0.2340 4.77224E-07 0.2340

```

```

1.7000E-02 3.34170E-03 0.0661 0.00000E+00 0.0000 5.05434E-04 0.0660 1.37446E-03 0.0661 4.49425E-06 0.0661
1.0000E-01 4.72587E-02 0.0165 0.00000E+00 0.0000 6.11329E-03 0.0166 1.94780E-02 0.0165 6.37382E-05 0.0165
4.0000E-01 1.94145E-01 0.0069 0.00000E+00 0.0000 1.68603E-02 0.0071 7.91001E-02 0.0069 2.58767E-04 0.0069
9.0000E-01 2.09957E-01 0.0059 0.00000E+00 0.0000 1.13657E-02 0.0060 8.42378E-02 0.0059 2.75947E-04 0.0059
1.4000E+00 1.33697E-01 0.0077 0.00000E+00 0.0000 4.79891E-03 0.0077 5.25212E-02 0.0077 1.71309E-04 0.0077
3.0000E+00 2.38680E-01 0.0057 0.00000E+00 0.0000 4.34611E-03 0.0060 8.99118E-02 0.0057 2.91954E-04 0.0057
2.0000E+01 1.52744E-01 0.0080 2.56445E-03 0.0234 5.41123E-04 0.0093 5.08832E-02 0.0079 1.63946E-04 0.0079
total 9.80264E-01 0.0019 2.56445E-03 0.0234 4.46220E-02 0.0036 3.77688E-01 0.0019 1.23075E-03 0.0019
SKIP 214 LINES IN OUTPUT

```

SKIP 214 LINES IN OUTPUT

**N42** tally 34 nps = 105235

```

tally type 4 track length estimate of particle flux.
tally for neutrons
number of histories used for normalizing tallies = 90000.00
multiplier bin 1: -1.00000E+00 10 -6 -7
multiplier bin 2: -1.00000E+00 10 16 : 17
multiplier bin 3: -1.00000E+00 10 -2
multiplier bin 4: -1.00000E+00 10 -6
multiplier bin 5: -1.93210E-05 10 1 -4
volumes
cell: 1

```

```

energy bin: 0. cell: 1.00000E+00
cell: 1 to 2.00000E+01
mult bin
1 1.04614E+00 0.0019
2 2.73727E-03 0.0234
3 4.76183E-02 0.0036
4 4.03067E-01 0.0019
5 1.31345E-03 0.0019

```

SKIP 214 LINES IN OUTPUT

STATUS of the statistical checks used to form confidence intervals for the mean for each tally bin

**N43**

```

tally result of statistical checks for the tfc bin (the first check not passed is listed) and error magnitude check for all bins
1 passed the 10 statistical checks for the tally fluctuation chart bin result
missed all bin error check: 17 tally bins had 8 bins with zeros and 2 bins with relative errors exceeding 0.10
6 passed the 10 statistical checks for the tally fluctuation chart bin result
missed all bin error check: 17 tally bins had 6 bins with zeros and 3 bins with relative errors exceeding 0.10
7 passed the 10 statistical checks for the tally fluctuation chart bin result
missed all bin error check: 17 tally bins had 6 bins with zeros and 3 bins with relative errors exceeding 0.10
14 passed the 10 statistical checks for the tally fluctuation chart bin result
missed all bin error check: 85 tally bins had 39 bins with zeros and 12 bins with relative errors exceeding 0.10
34 passed the 10 statistical checks for the tally fluctuation chart bin result
missed all bin error check: 5 tally bins all have relative errors less than 0.10 with no zero bins
for perturbation 1

```

```

1 missed 1 of 10 tfc bin checks: the slope of decrease of largest tallies is less than the minimum acceptable value of 3.0
missed all bin error check: 17 tally bins had 8 bins with zeros and 2 bins with relative errors exceeding 0.10

```



6 passed the 10 statistical checks for the tally fluctuation chart bin result  
missed all bin error check: 17 tally bins had 6 bins with zeros and 3 bins with relative errors exceeding 0.10  
7 passed the 10 statistical checks for the tally fluctuation chart bin result  
missed all bin error check: 17 tally bins had 6 bins with zeros and 3 bins with relative errors exceeding 0.10  
14 passed the 10 statistical checks for the tally fluctuation chart bin result  
missed all bin error check: 85 tally bins had 39 bins with zeros and 12 bins with relative errors exceeding 0.10  
34 passed the 10 statistical checks for the tally fluctuation chart bin result  
passed all bin error check: 5 tally bins all have relative errors less than 0.10 with no zero bins

the 10 statistical checks are only for the tally fluctuation chart bin and do not apply to other tally bins.  
the tally bins with zeros may or may not be correct: compare the source, cutoffs, multipliers, et cetera with the tally bins.

warning. 1 of the 10 tally fluctuation chart bins did not pass all 10 statistical checks.  
warning. 8 of the 10 tallies had bins with relative errors greater than recommended.  
ltally fluctuation charts

nps	tally 1				tally 6				tally 7						
	mean	error	vov	slope	fom	mean	error	vov	slope	fom	mean	error	vov	slope	fom
8000	0.0000E+00	0.0000	0.0000	0.0	0.0E+00	0.0000E+00	0.0000	0.0000	0.0	0.0E+00	0.0000E+00	0.0000	0.0000	0.0	0.0E+00
16000	5.7636E-01	0.0220	0.0017	10.0	76858	1.2343E-03	0.0227	0.0044	10.0	72080	1.3237E-03	0.0227	0.0044	10.0	72249
24000	5.7248E-01	0.0061	0.0001	10.0	75567	1.2495E-03	0.0063	0.0004	8.5	70107	1.3401E-03	0.0063	0.0004	10.0	70311
32000	5.7518E-01	0.0044	0.0001	10.0	77371	1.2448E-03	0.0046	0.0002	10.0	68130	1.3351E-03	0.0046	0.0002	10.0	68332
40000	5.7706E-01	0.0036	0.0000	10.0	77562	1.2460E-03	0.0038	0.0001	10.0	67617	1.3364E-03	0.0038	0.0001	10.0	67803
48000	5.7768E-01	0.0031	0.0000	10.0	78019	1.2472E-03	0.0033	0.0001	10.0	68177	1.3376E-03	0.0033	0.0001	10.0	68368
56000	5.7678E-01	0.0028	0.0000	10.0	77961	1.2480E-03	0.0030	0.0001	10.0	68180	1.3384E-03	0.0030	0.0001	10.0	68374
64000	5.7714E-01	0.0025	0.0000	10.0	78904	1.2476E-03	0.0027	0.0001	10.0	68777	1.3381E-03	0.0027	0.0001	10.0	68967
72000	5.7609E-01	0.0024	0.0000	10.0	78986	1.2496E-03	0.0025	0.0001	10.0	69264	1.3402E-03	0.0025	0.0001	10.0	69451
80000	5.7661E-01	0.0022	0.0000	10.0	79180	1.2479E-03	0.0024	0.0001	10.0	69182	1.3384E-03	0.0024	0.0001	10.0	69370
88000	5.7666E-01	0.0021	0.0000	10.0	79299	1.2469E-03	0.0022	0.0000	10.0	69127	1.3373E-03	0.0022	0.0000	10.0	69318
96000	5.7677E-01	0.0020	0.0000	10.0	79328	1.2469E-03	0.0021	0.0000	10.0	69275	1.3373E-03	0.0021	0.0000	10.0	69469
104000	5.7640E-01	0.0019	0.0000	10.0	79295	1.2468E-03	0.0020	0.0000	10.0	69328	1.3372E-03	0.0020	0.0000	10.0	69523
105235	5.7633E-01	0.0019	0.0000	10.0	79365	1.2468E-03	0.0020	0.0000	10.0	69448	1.3372E-03	0.0020	0.0000	10.0	69642

nps	tally 14				tally 34					
	mean	error	vov	slope	fom	mean	error	vov	slope	fom
8000	0.0000E+00	0.0000	0.0000	0.0	0.0E+00	0.0000E+00	0.0000	0.0000	0.0	0.0E+00
16000	9.8103E-01	0.0225	0.0041	10.0	73626	9.8097E-01	0.0225	0.0041	10.0	73626
24000	9.9532E-01	0.0063	0.0004	10.0	71707	9.9526E-01	0.0063	0.0004	10.0	71707
32000	9.9222E-01	0.0046	0.0002	10.0	69730	9.9217E-01	0.0046	0.0002	10.0	69730
40000	9.9339E-01	0.0038	0.0001	10.0	68937	9.9333E-01	0.0038	0.0001	10.0	68937
48000	9.9424E-01	0.0033	0.0001	10.0	69552	9.9419E-01	0.0033	0.0001	10.0	69552
56000	9.9483E-01	0.0027	0.0001	10.0	69584	9.9477E-01	0.0030	0.0001	10.0	69584
64000	9.9469E-01	0.0027	0.0001	10.0	70062	9.9464E-01	0.0027	0.0001	10.0	70062
72000	9.9616E-01	0.0025	0.0001	10.0	70471	9.9610E-01	0.0025	0.0001	10.0	70471
80000	9.9485E-01	0.0023	0.0001	10.0	70410	9.9479E-01	0.0023	0.0001	10.0	70410
88000	9.9395E-01	0.0022	0.0000	10.0	70371	9.9390E-01	0.0022	0.0000	10.0	70371
96000	9.9391E-01	0.0021	0.0000	10.0	70596	9.9386E-01	0.0021	0.0000	10.0	70596
104000	9.9396E-01	0.0020	0.0000	10.0	70644	9.9390E-01	0.0020	0.0000	10.0	70644

```

105235 9.9406E-01 0.0020 0.0000 10.0 70713 9.9400E-01 0.0020 0.0000 10.0 70713
tally fluctuation charts - for perturbation 1
tally 1
nps mean error vov slope fom 6 7
8000 0.0000E+00 0.0000 0.0000 0.0 0.0E+00 0.0000E+00 0.0000 0.0000 0.0 0.0E+00
16000 5.5289E-01 0.0213 0.0020 4.2 81934 1.2189E-03 0.0220 0.0037 10.0 76853 1.3070E-03 0.0220 0.0037 10.0 77072
24000 5.4933E-01 0.0059 0.0001 5.6 80248 1.2337E-03 0.0062 0.0004 9.5 73800 1.3230E-03 0.0062 0.0004 8.0 74057
32000 5.5230E-01 0.0042 0.0001 3.0 81931 1.2289E-03 0.0045 0.0002 10.0 72015 1.3179E-03 0.0045 0.0002 10.0 72265
40000 5.5367E-01 0.0035 0.0001 2.2 81947 1.2295E-03 0.0037 0.0001 10.0 71253 1.3186E-03 0.0037 0.0001 10.0 71490
48000 5.5319E-01 0.0030 0.0000 1.9 82486 1.2306E-03 0.0033 0.0001 10.0 71667 1.3197E-03 0.0032 0.0001 10.0 71910
56000 5.5326E-01 0.0027 0.0000 2.2 82439 1.2316E-03 0.0029 0.0001 10.0 71593 1.3208E-03 0.0029 0.0001 10.0 71838
64000 5.5359E-01 0.0025 0.0000 2.1 83450 1.2313E-03 0.0027 0.0001 10.0 72235 1.3205E-03 0.0027 0.0001 10.0 72475
72000 5.5262E-01 0.0023 0.0000 2.0 83596 1.2333E-03 0.0025 0.0001 10.0 72807 1.3226E-03 0.0024 0.0001 10.0 73046
80000 5.5314E-01 0.0021 0.0000 1.9 83789 1.2317E-03 0.0023 0.0001 10.0 72725 1.3209E-03 0.0023 0.0001 10.0 72965
88000 5.5332E-01 0.0020 0.0000 1.8 83945 1.2306E-03 0.0022 0.0001 10.0 72812 1.3197E-03 0.0022 0.0001 10.0 73055
96000 5.5335E-01 0.0019 0.0000 1.7 83990 1.2305E-03 0.0021 0.0000 10.0 72996 1.3196E-03 0.0020 0.0000 10.0 73243
104000 5.5306E-01 0.0018 0.0000 1.6 83958 1.2306E-03 0.0020 0.0000 10.0 73049 1.3197E-03 0.0020 0.0000 10.0 73296
105235 5.5300E-01 0.0018 0.0000 1.6 84048 1.2307E-03 0.0019 0.0000 10.0 73175 1.3198E-03 0.0019 0.0000 10.0 73421

```

```

tally 14
nps mean error vov slope fom 34
8000 0.0000E+00 0.0000 0.0000 0.0 0.0E+00 0.0000E+00 0.0000 0.0000 0.0 0.0E+00
16000 9.6798E-01 0.0217 0.0035 10.0 79053 1.0331E+00 0.0217 0.0035 10.0 79027
24000 9.8182E-01 0.0061 0.0004 8.6 76054 1.0478E+00 0.0061 0.0004 8.7 76067
32000 9.7869E-01 0.0045 0.0002 10.0 74184 1.0445E+00 0.0045 0.0002 10.0 74200
40000 9.7932E-01 0.0037 0.0001 10.0 73217 1.0451E+00 0.0037 0.0001 10.0 73235
48000 9.8008E-01 0.0032 0.0001 10.0 73711 1.0459E+00 0.0032 0.0001 10.0 73731
56000 9.8083E-01 0.0029 0.0001 10.0 73670 1.0467E+00 0.0029 0.0001 10.0 73692
64000 9.8073E-01 0.0026 0.0001 10.0 74161 1.0466E+00 0.0026 0.0001 10.0 74181
72000 9.8224E-01 0.0024 0.0001 10.0 74698 1.0482E+00 0.0024 0.0001 10.0 74718
80000 9.8096E-01 0.0023 0.0001 10.0 74636 1.0469E+00 0.0023 0.0001 10.0 74655
88000 9.8006E-01 0.0021 0.0000 10.0 74758 1.0459E+00 0.0021 0.0000 10.0 74776
96000 9.7991E-01 0.0020 0.0000 10.0 75006 1.0458E+00 0.0020 0.0000 10.0 75023
104000 9.8013E-01 0.0019 0.0000 10.0 75052 1.0460E+00 0.0019 0.0000 10.0 75070
105235 9.8026E-01 0.0019 0.0000 10.0 75139 1.0461E+00 0.0019 0.0000 10.0 75156

```

```

*****
dump no. 2 on file kcode.r nps = 105235 coll = 364239 ctm = 3.81 nrrn = 5379507
*****

```

```

11 warning messages so far.
run terminated when 35 kcode cycles were done.

```

```

computer time = 3.86 minutes
mcnp version 4c 01/20/00 07/31/00 12:16:05 probid = 07/31/00 12:11:37

```

## CHAPTER 5

### KCODE

#### Notes:

- N1: This model of Godiva was suggested by the LANL Nuclear Criticality Safety Group ESH-6 and is from LA-4208.
- N2: The ZAID.61c cross sections are used to include the proper delayed neutron data from ENDF6.
- N3: The KCODE card indicates this is a criticality calculation with a nominal source size of 3000 particles per cycle, an estimate of  $k_{eff}$  of 1.0, skip 5 cycles before averaging  $k_{eff}$  or tallying, and run a total of 35 cycles if computer time permits. A tally batch size of 30 is large enough to ensure that the standard normal distribution confidence interval statements at the  $1\sigma$  and  $2\sigma$  levels should apply. A total of 3000 particles was selected to run the problem in less than 5 minutes. Tally normalization will be by the starting source weight by default.

To normalize a criticality calculation by the steady-state power level of a reactor, use the following conversion:

$$\left(\frac{1 \text{ joule/sec}}{\text{watt}}\right)\left(\frac{1 \text{ MeV}}{1.602 \text{ E} - 13 \text{ joules}}\right)\left(\frac{\text{fission}}{180 \text{ MeV}}\right) = 3.467\text{E}10 \text{ fission/watt} - \text{sec}$$

Therefore, to produce P watts of power, one needs 3.467E10P fissions per second. This produces 3.467E10 x P x  $\bar{\nu}$  neutrons/s, which is the source strength for this power level, or a source strength of 9E10P neutrons/s. The normalization should be in the tally on the FM card and NOT in the source on an SDEF card.

The tallies must be scaled by the steady state power level of the critical system in units of fission neutrons per unit time. For example, if Godiva is operating at a power level of 100 watts, the tally scaling factor would be (100 x 3.467 x 10<sup>10</sup> fission/s) (2.5977 neutrons/fission) = 9.0 x 10<sup>12</sup> neutrons/s. (The value  $\bar{\nu}$  comes from the 1st and 4th bins of tally 14,  $\bar{\nu} = .994059/.382672$ .) The tallies will then have the same time units. Tallies for subcritical systems do not include any multiplication effects because fission is treated as an absorption. Tallies can be estimated for subcritical systems by multiplying the results by the system multiplication  $1/(1-k_{eff})$ . See Chapter 2 Sec. VIII for further discussion.

- N4: One source location at the center of the 94% enriched uranium sphere is used to begin the first cycle. When an SRCTP file is used, the KSRC card should be removed.

The sources for each generation are the fission locations and neutron energies from fission found in the previous generation. Therefore, in a  $k_{eff}$  calculation the fission

## CHAPTER 5

### KCODE

distribution converges to a stable distribution as a function of space. For complicated problem geometries, the fission distribution must converge for the calculated  $k_{eff}$  to converge. This effect is minimized by sampling a larger number of particles per generation. Usually the first generation source is not too important because subsequent later sources will have converged. If the user source selects good source points on the KSRC card, the problem will converge to a stable  $k_{eff}$  in fewer generations. It is critical that the source points have converged before  $k_{eff}$ s and tallies are calculated to ensure proper mean  $k_{eff}$ s and confidence intervals.

The correct source distribution is proportional to the product of the macroscopic fission cross-section and the neutron flux that, in turn, is proportional to the power. The approximate power distribution is often known and can provide guidance for the initial source definition. The closer the initial source definition is to the correct distribution the faster the convergence of  $k_{eff}$  will be.

- N5: The PERT card perturbs the density of cell 1. The effect of increasing the density from 18.74 g/cc to 20.0 g/cc will be estimated for each of the tallies in the problem using the differential operator technique, including the k eigenvalue estimated by KCODE. The METHOD = -1 causes the estimated change to be combined with the unperturbed value to give the perturbed value directly. Because large perturbations can cause the differential operator technique to break down, it is suggested that the perturbation not exceed 25%. The perturbation capability also assumes that the underlying fundamental mode (flux shape) is not affected significantly.
- N6: This note shows the use of the FM card to calculate the quantities described by the FC14 comment card. The atom density times the volume of the sphere is 132.534 atoms-cm<sup>3</sup>/barn-cm and is used as a multiplier to obtain reaction rates. Tallies 14 and 34 achieve the same tallies in two different ways. The first multiplier bin is the total number of neutrons created by fission per source neutron. This value is equal to the track length estimate of  $k_{eff}$ . The second multiplier bin is the total number of neutrons lost to (n,xn) reactions. The third multiplier bin is the total number of absorptions. This value is slightly different from the total capture in the problem summary because the tally is a track length estimator and the summary table uses an absorption estimator. The fourth multiplier bin is an estimate of the total number of fissions. The fifth multiplier bin is the total neutron heating tally. The multiplier for the fifth bin is the atom density divided by the gram density of cell 1 to calculate heating in units of MeV/gram. (The two constants are slightly wrong but do not affect overall results.)
- N7: The E0 card uses the Hansen-Roach energy structure as the energy bins for all tallies except tally 34 because an E34 card exists.

## CHAPTER 5

### KCODE

- N8: Tally 34 demonstrates an alternate way to specify the tallies listed in tally 14. The SD34 card divides the tally by a volume of one instead of by the real volume, which is equivalent to multiplying the tally by the volume. The constant on multiplier bin 5 (heating tally) is 1/gram density of cell 1/cell volume. Remember that the SD34 card replaced the real volume by a value of one, effectively multiplying by the volume. In the unperturbed case the bin 5 tally gives the same results as tally 14. See other notes discussing the perturbed tallies.
- N9: Print Table 90 gives detailed information about the criticality source from the KSRC card, including points accepted and rejected. Entries from the KCODE card are echoed. Table 90 shows that total (as opposed to prompt) fission  $\bar{\nu}$  data are being used by default to account for the effect of delayed neutrons. Delayed neutrons are generated according to the proper delayed neutron fraction for a fissile material and their energy is sampled from the appropriate delayed neutron spectrum. The delayed neutron libraries are contained in the ZAIID.61c cross sections, therefore these cross sections must be specified in order to properly model delayed neutrons. Delayed neutrons typically have a softer spectrum than prompt neutrons; neglecting this difference in energy can have a small affect. Delayed neutron production can be turned off using the TOTNU card.
- N10: These warnings alert the user to the fact that tallies with positive multipliers (tally 14) may not be properly perturbed, and the results reported may be erroneous. Generally, negative multipliers are needed if tallies involve perturbed materials. Tallies not involving materials, or only involving unperturbed nuclides, are generally safe.
- N11: A warning of unnormalized fractions was issued because the sum of the material fractions from the M10 card is not the same as the density in cell 1 and was also not unity. Generally F6 and F7 tallies are correctly perturbed and this warning is unnecessary.
- N12: These warnings indicate that the density perturbation may not be properly corrected for the neutron energy deposition tally (tally 6) or the fission energy deposition tally (tally 7). Generally the F6 and F7 tallies are correctly perturbed.
- N13: These densities and volumes were used in determining the multipliers for the FM card.
- N14: The cross-section tables show that all three isotopes use the total  $\bar{\nu}$ . These particular evaluations also have the full delayed neutron energy-time distributions.
- N15: If cross-section space required is too large, thinned or discrete reaction cross-section sets can be used for isotopes with small atom fractions (see Print Table 40), although

## CHAPTER 5

### KCODE

we recommend just buying more disk space. Note that the required dynamically-allocated storage is given in both decimal words and bytes, but the fixed-dimension storage and code executable sizes are not given.

- N16: An SRCTP file has been generated (kcode.s) for possible use as a source in future versions of the problem.
- N17: Print Table 110 shows starting information about the first 50 histories and indicates that all source points are at the origin as specified on the KSRC card. The directions are isotropic and the energy is sampled from a Watt fission spectrum for the first cycle.
- N18: Five cycles are skipped before averaging of  $k_{eff}$  and prompt removal lifetimes. Tallies, photon production, DXTRAN summary and activity tables, and other options are also turned off during the first five cycles. Cycle 6 is the first active cycle. Cycle 7 begins simple averages over active cycles. Cycle 8 begins 2-combined estimators that require a minimum of three active cycles. Cycle 9 begins 3-combined estimators of  $k_{eff}$  and prompt removal lifetimes.
- N19: There are three  $k_{eff}$  and prompt removal lifetime estimators, and they use the collision, absorption, and track length methods discussed in Chapter 2.VIII.B. All combinations of these estimators are included. The positive correlations of the various  $k_{eff}$  and prompt removal lifetime estimators result in almost no reduction in the relative errors for the combined estimators. The estimator with the smallest relative error is generally selected. After 35 total cycles and 30 averaging cycles, all of the  $k_{eff}$  values agree well at  $\sim 0.9935$  and have an estimated relative error at the  $1\sigma$  level of 0.0022 to 0.0032. File SRCTP contains the 2856 source points that were generated during cycle 35.
- N20: The problem summary provides information for the 30 active cycles. The source particle weight for summary table normalization is the requested 30 cycles x 3000 histories/cycle = 90,000 histories. Whenever the default tally normalization by source particle weight is used, the source weight is always exactly 1.000. The neutrons created from both prompt and delayed fission are zero because the actual fission neutrons produced are written to the source for the next cycle. In a noncriticality problem with a point source, both these values would be nonzero provided that the proper cross sections were used. The loss side of the table gives general guidelines about what happened in the problem. The values will not agree exactly with separate tallies in the problem because collision estimators are used for the summary table and track length estimators are used for the tallies. The loss to fission category is for the weight lost to fission, which is treated as a terminal event for the criticality calculation. Parasitic capture is listed separately. No tracks were lost to either the capture or fission

## CHAPTER 5

### KCODE

categories because implicit capture is being used (the default for EMCNF with no PHYS:N card present is 0). Capture and absorption both mean (n,0n).

- N21: Hundreds, often thousands, of values of  $k_{eff}$  are printed in a single KCODE problem. This page is the summary page which features the single best estimate of  $k_{eff}$  clearly outlined: “the final estimated combined collision/absorption/track-length  $k_{eff} = 0.99408$  with an estimated standard deviation of 0.00220.” This summary page also includes a check to determine if each cell with fissionable material had tracks entering, collisions, and fission source points to assess problem sampling. Fissionable cells that have no entering tracks may indicate geometry errors on the part of the user, excessive detail in the user's problem setup, or undersampling that can lead to an underestimate of  $k_{eff}$ . Normality tests are made of the active  $k_{eff}$  values for each estimator. If the  $k_{eff}$  estimates are not normally distributed, then all the Monte Carlo assumptions based upon the Central Limit Theorem may be suspect. In particular, the estimated relative errors and confidence intervals may be underestimated. See the discussion in Chapter 2. Note that all error estimators for  $k_{eff}$  are standard deviations, not relative errors.
- N22: The summary page also gives a table of  $k_{eff}$  and confidence intervals if the largest value of  $k_{eff}$  for each estimator were to occur on the next cycle. This information provides an indication of the “upper bound” of  $k_{eff}$  in a worst-case sampling scenario. This is one of the more useful indicators of how well converged the estimation of  $k_{eff}$  is.
- N23: Three estimates (col/abs/trk len) and all combinations are made of the prompt removal lifetimes, including standard deviations, just as is done for  $k_{eff}$ . Lifetimes are quoted in seconds rather than shakes. Then the lifespans and lifetimes are summarized. The escape and capture lifespans are exactly the same as the “average time of” in the summary table because all KCODE source particles start at time zero. The removal lifespan is identical to the prompt removal lifetime. The slight difference between removal lifespan and removal lifetime (abs) is because the lifespan is history averaged and the removal lifetime (abs) is batch averaged. The removal lifetime (c/a/t) is slightly different because the collision and track length estimators are included. The “fraction”  $f_i$ , where  $i = \text{escape, capture (n,0n), and fission}$ , is the weight lost per source particle from the summary table normalized so that  $f_e + f_c + f_f = 1.0$ . In the present example ~57% of the source neutrons escape, this is to be expected for such a small assembly where the neutron mean free path is within a few factors of the radius of the sphere. The lifetimes are defined as  $\tau_x = \tau_r / f_x$  where  $x = e, c, f$ . That is, the escape, capture, and fission lifetimes are defined in terms of their loss fractions  $f_x$  and the removal lifetime  $\tau_r$ , and have nothing to do with their respective lifespans. The lifespans are the average time from source to an event; the lifetimes are the average time between fission or the mean time between captures (n,0n). An absorption

## CHAPTER 5

### KCODE

estimator is used to calculate the lifespans. Thus the absorption estimate of the lifetime is presented for consistency. The best lifetime estimator is the 3-combined covariance-weighted lifetime (c/a/t).

- N24: This section gives the value of  $k_{eff}$  that was estimated for a density of 20.0 g/cc using the differential operator perturbation technique on the track length estimator of  $k_{eff}$ . This technique estimates that a Godiva with a density of 20.0 g/cc would have an eigenvalue of 1.04614 with a standard deviation of 0.00234. This value compares very well with the result obtained from running a separate problem with the increased density ( $k_{eff}=1.04393 \pm 0.00255$ ).
- N25: The batch table approximates alternate batch size values. It shows  $k_{eff}$  and its variance as it would have been calculated with a different number of  $k_{eff}$  cycles per batch to assess  $k_{eff}$  correlation effects. This table saves making dozens of independent MCNP calculations to get the same information. For this problem there are seven different batch combinations: 30 batches of 1 cycle, 15 batches of 2 cycles, 10 batches of 3 cycles, 6 batches of 5 cycles, 5 batches of 6 cycles, 3 batches of 10 cycles, and 2 batches of 15 cycles. The batch size table is not the same as running 15 active cycles with 6000 histories each or 10 active cycles with 9000 histories each. It is approximate because each cycle is still generated from the previous cycle rather than each batch being generated from the previous batch. The batch table is intended to see if the variance (and confidence interval) changes much by averaging over cycles to reduce the cycle-to-cycle correlation. If there is a significant change in the variance (over 30%) then there may be too much correlation between cycles. In that case the more conservative variance and confidence interval may be the larger values of the variance and confidence interval from the batch size table summary (N26).
- N26: The above alternate batch size results are summarized with confidence intervals and a normality check. The confidence intervals can be compared to assess if there appears to be a substantial cycle-to-cycle correlation effect. Because the estimated standard deviation itself has a statistical uncertainty, it is recommended to use collapses that produce at least 30 batches.
- N27: This is the  $k_{eff}$ -by-cycle table. The individual and average  $k_{eff}$  estimator results by cycle repeats the information printed while the run was in progress (see notes N18 and N19) in a more readable format. A  $k_{eff}$  figure of merit is also included.
- N28: The largest and smallest values for each of the three  $k_{eff}$  estimators and the cycle at which they occurred is provided.



## CHAPTER 5

### KCODE

- N29: The  $k_{eff}$ -by-cycle table results for the combined col/abs/track-length estimator are plotted. The final  $k_{eff}$  value (0.99408) is marked with the vertical line. This plot should be examined for any trends in the average  $k_{eff}$ . The plot shown appears to have such a trend, indicating the problem requires more settle cycles or should be run farther.
- N30: This is the  $k_{eff}$ -by-number-of-active-cycles table. It provides a summary of what the results for each estimator and the combined col/abs/track-length would be had there been a different number of settle or skip cycles and active cycles. The combination actually used in this problem, 5 settle cycles and 30 active cycles, is marked with an asterisk (\*). Unlike the approximate batch table, the skip/active cycle table provides exactly the results you would have had by changing the number of skip/active cycles.
- N31: The skip/active cycle resulting in the minimum  $k_{eff}$  error is identified. In this problem it is for 4 settle cycles and 31 active cycles rather than 5 and 30. If the best combination is significantly greater than the number of cycles actually skipped, the normal spatial mode may not have been achieved in the skipped cycles and the problem should be rerun with more settle cycles.
- N32: The  $k_{eff}$  and its estimated standard deviation for the first and second active halves of the problem are checked to see if they appear to be statistically the same value.
- N33: The active cycle table (N30) is plotted. The final  $k_{eff}$  value (0.99408) is marked with the vertical line. This plot also exhibits an obvious trend indicating that the problem is poorly converged. The estimation of  $k_{eff}$  clearly decreases with decreasing number of active cycles, caused by placing the KSRC source in the center of the assembly. A neutron born in the center of the sphere has a much larger probability of causing fission and therefore over estimates  $k_{eff}$ . The initial cycles have a source that is biased toward the center and as the source updates from cycle to cycle the source spreads outward toward the correct distribution, lowering  $k_{eff}$ .
- N34: The F1 total leakage tally agrees exactly with the total weight lost to escape in the problem summary table, see note N20.
- N35: The F6 heating tally in the uranium sphere does not include any estimate from photons. To account for photons, a coupled neutron/photon criticality problem must be run using a MODE N P card. An F7 fission heating tally may give a good approximation, see note N36.
- N36: The F7 fission heating tally is larger than the F6 total heating tally because the F7 tally includes photons and the F6 tally does not. The fission heating estimate assumes that all photons are deposited locally. The difference between the F6 and F7 tally is

## CHAPTER 5

### KCODE

discussed on page 2-81. Because Godiva is an optically thick system to photons, the F7 tally should be a good approximation to the total heating. A MODE N P calculation of this problem produced a neutron heating (F6) of  $1.242 \times 10^{-3}$  (0.0020) MeV/g and a photon heating of  $6.491 \times 10^{-5}$  (0.0038), which adds to about the estimate of the F7 tally,  $1.337 \times 10^{-3}$  (0.0020) (the estimated relative errors are listed in parentheses). If the 100 watt power level normalization in note 3 is used to scale tally 7, (100 Watts)  $(1.337 \times 10^{-3} \text{ MeV/g}) (51931 \text{ g}) (9.0 \times 10^{10} \text{ neutrons/s}) (1.602 \times 10^{-13} \text{ W/MeV/s}) = 100.106 \text{ watts}$ . Thus, the source normalization and tally are consistent with the 100 watt assumed power level.

- N37: The F14 flux tally has five multiplier bins. The tallies below 0.1 MeV are small because there is no moderator. Multiplier bin 1 is the total number of fission neutrons produced, per source neutron, and agrees exactly with the track length  $k_{eff}$  estimator described in notes N19 and N21. The estimated errors differ because  $k_{eff}$  (track length) is a batch averaged standard deviation while the tally is a history averaged relative error. Bin 2 estimates the number of neutrons lost to (n,xn) reactions. The difference between this track length tally and the collision estimate in the problem summary (N20) is purely statistical. Multiplier bin 3 estimates absorption (n,0n), which agrees with the problem summary weight lost to capture (n,0n) with a slight difference between the tally track length estimator and the problem summary absorption estimator. Multiplier bin 4 gives the total number of fissions, as opposed to the total number of fission neutrons in bin 1. Dividing multiplier bin 1 by multiplier bin 4 gives the average value of  $\bar{\nu}$  of 2.5977 neutrons produced per fission. Multiplier bin 5 is the total neutron heating tally that agrees exactly with the F6 tally.
- N38: Tally 34 illustrates a different way of doing tally 14 using the SD card. The SD card sets the tally divisor to one, not the volume, which has the same effect as multiplying by the volume. Note how the first multiplier bin, the track length estimate of  $k_{eff}$ , is identical to the first multiplier bin in tally 14, which is multiplied by the atom density times the volume. The second multiplier bin is the (n,2n) + (n,3n) reaction rate; that is, the track length estimate of the total loss to (n,xn), and is in good agreement with the (n,xn) estimate in the problem summary table. Multiplier bins 3 and 4 are the absorption (n,0n) and fission rates, which agree exactly with multiplier bins 3 and 4 in tally 14 and differ from the weight lost to capture (n,0n) and fission in the problem summary table only by the difference between track length estimators and absorption estimators. Multiplier bin 5 is the heating tally and it agrees exactly with bin 5 of tally 14 and also tally 6. Tally 14 and tally 34 agree to within the precision of the constants specified on the FM card.

## CHAPTER 5

### KCODE

- N39: The tallies that follow have been corrected for the perturbation. The perturbation capability assumes that the underlying fundamental mode (flux shape) is not affected significantly.
- N40: This table lists the perturbed result of tally 1, the total leakage (escape) from the assembly when the density was increased to 20 g/cc. As expected, increasing the material density decreases the mean free path of a neutron and decreases the leakage from the assembly.
- N41: The perturbed results of tally 14 should be immediately questioned because the track length estimate of  $k_{eff}$  (multiplier bin 1) is not equal to the perturbed  $k_{eff}$  track length estimate in N24. The positive bin multiplier caused this error. Perturbation of a cross-section-dependent tally requires a negative multiplier so that a needed correction is made--see page 2-189. Bins 1-4 are wrong. Bin 5 is correct because it is a cross-section-independent tally that does NOT need the correction, so a positive multiplier is correctly used. See note N10.
- N42: Since tally 34 used negative bin multipliers the perturbed values for this tally are correct. Note that bin 1 is equal to the perturbed track length estimate in N24 ( $k_{eff} = 1.04614$ ).
- N43: The tally fluctuation charts confirm stable, efficient tallies in the bins monitored. The charts confirm that the first five cycles (15231 histories) were skipped because of the zeros after 8000 particles were run and the large reduction in the estimated relative error between 16000 and 24000 histories. These charts include both the perturbed and unperturbed results for the selected bins.

A few final points should be made about KCODE calculations. To make a KCODE calculation using the SRCTP source points file produced by a previous run, remove the KSRC card from the input file. To do a continue-run, the standard MCNP rules apply. Having an input file beginning with CONTINUE may be needed. If the previous run terminated because all the cycles requested by the KCODE card were completed, another KCODE card in a continue-run input file with a new total (not how many more) number of cycles to run is needed. Otherwise, only one more cycle will be run and the code will stop again. If the previous run was interrupted and stopped before all KCODE card cycles were completed, a continue-run input file is not needed. The code will start where it was stopped and continue until it is finished. The SRCTP file is not required for a KCODE continue-run because the source points information is contained on the RUNTPE file.

## CHAPTER 5 EVENT LOG AND GEOMETRY ERRORS

### V. *EVENT LOG AND GEOMETRY ERRORS*

MCNP cannot detect a geometry error while processing data from the INP file. Particles must actually be run and when a particle gets to a place in the geometry that is not correctly specified, it gets lost—it simply does not know where to go next. When ten particles get lost, MCNP stops. If this happens, you will get in the output file a debug print and event-log print for each of ten lost particles. The default of ten lost particles for printing and termination can be changed with the LOST card but is generally an unwise thing to do. See page 3-8 for a more complete discussion of how to use the plotter and set up a problem to flood the geometry with particles to check for geometry errors.

#### A. *Event Log*

An event-log print is produced by a lost particle and also by the third and fourth entries on the DBCN card. When a particle gets lost, the history is rerun and event-log printing is turned on during the rerun, making some of the summary information slightly incorrect. The following example is from the file CONC2, which is the same as the CONC problem with all of the tallies taken out. CONC2 runs only two histories (nps 2) and an event log is forced by a DBCN card (dbcn 2j 1 2). The shell is given an importance of two to cause particles to split when they leave the source cell and enter the shell. The event log is reproduced on the next page. In column 1 of the event log, *SRC* is source, *S* is surface, *C* is collision, *T* is termination, *BNK* is return a track from the bank, and *R* refers to the reaction type used. See TABLE F-8 in Appendix F for a full description of the TYR Block, which explains the value for R.

5-100

1		event log for particle history no.								1	ijk = 6647299061401			
	cell	x	y	z	u	v	w	erg	wgt		nch	nrn		
src	1	0.000+00	0.000+00	0.000+00	5.085-01	4.733-01	7.193-01	1.400+01	1.000+00			2		
s	2	1.831+02	1.704+02	2.590+02	5.085-01	4.733-01	7.193-01	1.400+01	5.000-01	surf= 1	npa= 1	2		
c	2	1.841+02	1.714+02	2.604+02	-2.302-01	9.676-01	1.039-01	5.760+00	3.832-01	14000.60c r= -1	1	10		
t	2	1.841+02	1.714+02	2.604+02	-2.302-01	9.676-01	1.039-01	5.760+00	3.832-01	energy cutoff		10		
bnk	2	1.831+02	1.704+02	2.590+02	5.085-01	4.733-01	7.193-01	1.400+01	5.000-01	n imp split		2	10	
c	2	1.837+02	1.709+02	2.598+02	-6.893-02	5.267-01	8.473-01	1.369+01	4.315-01	8016.60c r= -99	2	17		
c	2	1.826+02	1.786+02	2.722+02	-7.468-01	6.133-01	2.574-01	6.209+00	3.706-01	8016.60c r= -1	3	25		
t	2	1.826+02	1.786+02	2.722+02	-7.468-01	6.133-01	2.574-01	6.209+00	3.706-01	energy cutoff		25		

18 December 2000

1		event log for particle history no.								2	ijk = 130407176137285			
	cell	x	y	z	u	v	w	erg	wgt		nch	nrn		
src	1	0.000+00	0.000+00	0.000+00	8.952-01	-4.447-01	-2.944-02	1.400+01	1.000+00			27		
s	2	3.223+02	-1.601+02	-1.060+01	8.952-01	-4.447-01	-2.944-02	1.400+01	5.000-01	surf= 1	npa= 1	27		
c	2	3.239+02	-1.609+02	-1.065+01	4.894-01	-4.941-01	7.186-01	1.337+01	4.315-01	8016.60c r= -99	1	34		
c	2	3.268+02	-1.638+02	-6.379+00	3.521-02	-5.238-01	8.511-01	1.318+01	3.666-01	8016.60c r= -99	2	41		
c	2	3.273+02	-1.706+02	4.542+00	-8.751-01	4.809-01	5.465-02	1.206+01	2.788-01	14000.60c r= -99	3	48		
s	1	3.193+02	-1.662+02	5.039+00	-8.751-01	4.809-01	5.465-02	1.206+01	2.788-01	surf= 1	npa= 0	49		
s	2	-3.091+02	1.791+02	4.429+01	-8.751-01	4.809-01	5.465-02	1.206+01	2.788-01	surf= 1	npa= 0	49		
c	2	-3.118+02	1.806+02	4.445+01	-8.487-01	4.124-01	-3.311-01	1.199+01	2.422-01	13027.60c r= -99	4	56		
t	2	-3.118+02	1.806+02	4.445+01	-8.487-01	4.124-01	-3.311-01	1.199+01	2.422-01	energy cutoff		56		
bnk	2	3.223+02	-1.601+02	-1.060+01	8.952-01	-4.447-01	-2.944-02	1.400+01	5.000-01	n imp split		27	56	
c	2	3.228+02	-1.603+02	-1.062+01	7.289-01	-6.728-01	-1.264-01	1.392+01	4.315-01	8016.60c r= -99	5	63		
c	2	3.319+02	-1.688+02	-1.220+01	8.532-01	-5.113-01	-1.026-01	1.391+01	3.441-01	20000.60c r= -99	6	70		
c	2	3.349+02	-1.705+02	-1.256+01	8.348-01	-5.275-01	-1.580-01	1.390+01	3.035-01	11023.60c r= -99	7	77		
c	2	3.364+02	-1.715+02	-1.285+01	9.181-01	-3.018-01	2.570-01	1.089+01	3.035-01	1001.60c r= -99	8	97		
t	2	3.364+02	-1.715+02	-1.285+01	9.181-01	-3.018-01	2.570-01	1.089+01	3.035-01	energy cutoff		97		

## CHAPTER 5

### EVENT LOG AND GEOMETRY ERRORS

The first neutron starts with the correct parameters and immediately crosses surface 1 into cell 2 as we would expect because cell 1 is a void. The cell importance increases to 2 in cell 2 and the original particle is split into two tracks, one of which is put in the bank (NPA=1) and the other followed. If there had been a four-for-one split instead of two-for-one as we have here, NPA would be 3 indicating one entry into the bank representing three tracks.

The next event is a collision for the track that is being followed. It has an inelastic collision in the center of mass system ( $r = -1$ ) with silicon (14000.60c) in cell 2. Its energy after the collision is 5.760 MeV, which results in a termination because the energy cutoff in the problem is 12 MeV.

At this point the bank is checked for any tracks and one is found that got there as a result of importance sampling.

“n imp split” means the particle was put in the bank at random number  $nrn = 2$  from a split occurring at a surface. That track is started at the point where it was created and it has an elastic collision in the center of mass system ( $r = -99$ ) with oxygen (8016.60c). Its energy after the collision is 13.69 MeV. A second collision with oxygen follows in the center of mass system, but this time it is inelastic with one neutron out. The energy after collision is 6.209 MeV, resulting in its termination due to energy cutoff.

The second source particle is started. It is split, has two collisions with oxygen, one collision with silicon, and crosses surface 1 back into cell 1. The particle then crosses back into cell 2, has one collision and is terminated because of energy cutoff. The second track of this second source neutron is returned from the bank. It has four collisions, falls below the energy cutoff, and is terminated.

By default only 600 lines of the event log are printed for each history. This value can be changed by the fifth entry on the DBCN card.

## CHAPTER 5 EVENT LOG AND GEOMETRY ERRORS

### B. *Debug Print*

In addition to getting the event-log print for a lost particle, you will also get a debug print that gives you additional information. It tells you what the geometry description is in terms of cell/surface relations at the point the particle got lost. Sometimes the problem is an incorrectly specified sense.

If the geometry of Figure 4.11 in Chapter 4, page 4–5, is specified incorrectly such that the undefined tunnel going off to the right of surface 5 remains, you will get the following debug print:

```
1      lost particle no. 1      no cell found in subroutine newcel      history no. 21
the neutron currently being tracked has reached surface 5. there
appears to be no cell on the other side of the surface from cell 2
at that point.
the neutron is in cell 2.
x,y,z coordinates:      -9.88564E-01      5.00000E+00      1.68033E-01
u,v,w direction cosines: -1.97652E-01      9.79696E-01      3.35962E-02
energy = 1.40000E+01      weight = 1.00000E+00      time = 9.77199E-02
sqrt(z**2+x**2) = 1.00274E+00
the distance to surface 5 from the last event is 2.04145E+00
the distance to collision from the last event is 1.00000E+37
the number of neutron collisions so far in this history is 0.
the cells so far found on the other side of surface 5 of cell 2
(and the surface with respect to which the point x,y,z had the wrong sense) are:
(see chapter 5 of the mcnp manual.)
3
```

The  $x,y,z$  coordinates give the location of the particle when it got lost. If the geometry is plotted with  $x,y,z$  as the origin, the geometry in the vicinity of the lost particle can be examined. Dashed lines in the plot indicate the improperly specified portion of the geometry (see page 3-8).

The last paragraph of the debug print pinpoints the geometry error. The particle has just exited cell 2 by crossing surface 5. The only known cell on the other side of surface 5 from cell 2 is cell 3. However, cell 3 has been defined as (2:-1) (4:5:-3). The particle is in the undefined tunnel region (-2 5), not in cell 3. If cell 3 were only the area to the right of surface 5 and defined without the union operator, the debug print would be even more specific, listing 3 (2) to indicate that the particle has the wrong sense with respect to surface 2 of cell 3.

**CHAPTER 5**  
**EVENT LOG AND GEOMETRY ERRORS**



**CHAPTER 5**  
**EVENT LOG AND GEOMETRY ERRORS**

## APPENDIX B

### MCNP GEOMETRY AND TALLY PLOTTING

MCNP has two plotting capabilities. The first, PLOT, is used to plot two-dimensional slices of a problem geometry specified in the INP file. The second, MCNPLOT, plots tally results produced by MCNP and cross-section data used by MCNP. Section I of this appendix addresses system issues external to MCNP related to graphics. Section II discusses how to invoke the PLOT features. Section III discusses how to invoke the MCNPLOT features. A complete explanation of each set of input commands is given. Lines the user will type are shown in lower case typewriter type. Press the RETURN key after each input line.

#### *I. SYSTEM GRAPHICS INFORMATION*

The implementation of plotting in MCNP may differ slightly from installation to installation. Table B-1 lists the graphics systems and features supported by MCNP. These graphics libraries are device-independent in general and give considerable flexibility in processing graphical output. Table B-2 shows supported graphics/computer system combinations.

**TABLE B-1:  
Supported Graphics Feature**

	Metafile	Color	Locate and Cursor commands	Auto Sizing
X-window	p	x	x	x
CGS	x		x	
GKS	x	x	x	
DVF Quickwin	p	x		
LAHEY Winteractor	p	x		

x=supported    p=metafile is standard postscript file

**TABLE B-2:  
Graphics/Computer System Combinations**

	X-window	GKS	DVF Quickwin	LAHEY Winteractor	CGS
UNICOS	s	s	u	u	
Sun Solaris	s		u	u	
IRIX	s		u	u	
AIX	s	s	u	u	
HPUX	s		u	u	
ULTRIX	s		u	u	

**APPENDIX B**  
**SYSTEM GRAPHICS INFORMATION**

**TABLE B-2: (Cont.)**  
**Graphics/Computer System Combinations**

PC Linux	s		u	u	
PC Windows DVF	s		s	u	
PC Windows LF	s		u	s	
VMS	u		u	u	

s=supported    u=unavailable    blank=not tested

MCNP uses the ANSI GKS (Graphics Kernel System<sup>1</sup>) standard for graphics. If GKS is not available or is defective, subroutines that simulate GKS can be called. This is done for all other graphics systems listed in Table B-1, of which most use routines compatible with Tektronix output devices. (The TERM command sets the output device type.) See also Appendix C.

**A. X-Windows**

The X-window graphics library allows the user to send/receive graphics output to/from remote hosts as long as the window manager on the display device supports the X protocol (e.g., OPENWINDOWS, MOTIF, etc.). Prior to running MCNP, perform the following steps to use these capabilities. Note that these steps use UNIX C-shell commands.

1. On the host that will execute MCNP, enter:

```
setenv DISPLAY displayhost:0
```

where *displayhost* is the name of the host that will receive the graphics.

2. In the CONSOLE window of the display host enter:

```
xhost executehost
```

where *executehost* is the name of the host that will execute MCNP.

With either the ‘setenv’ or ‘xhost’ commands, the host IP address can be used in place of the host name, useful when one remote system does not recognize the host name of another.; for example,

```
setenv DISPLAY 128.10.1:0
```

**REFERENCE**

1. “American National Standard for Information Systems–Computer Graphics–Graphical Kernel System (GKS) Functional Description,” ANSI X3.124--1985, ANSI, INC.

## II. THE PLOT GEOMETRY PLOTTER

The geometry plotter is used to plot two-dimensional slices of a problem geometry specified in the INP file. This feature of MCNP is invaluable for debugging geometries. You should first verify your geometry model with the MCNP geometry plotter before running the transport part of MCNP, especially with a complicated geometry in which it is easy to make mistakes. The time required to plot the geometry model is small compared with the potential time lost working with an erroneous geometry.

In this appendix, plot options and keywords are shown in upper case, but are usually typed by the user in lower case.

### A. PLOT Input and Execute Line Options

To plot geometries with MCNP, enter the following command:

```
mcnp ip inp=filename options
```

where ‘ip’ stands for initiate and plot. “Options” is explained in the next paragraph. The most common method of plotting is with an interactive graphics terminal. MCNP will read the input file, perform the normal checks for consistency, and then the plot prompt *plot>* appears.

The following four options can be entered on the execution line:

- |             |  |
|-------------|--|
| NOTEK       | Suppress plotting at the terminal and send all plots to the graphics metafile, PLOTM. For production and batch situations and when the user’s terminal has no graphics capability. Available only with certain graphics systems.   |
| COM=aaaa    | Use file aaaa as the source of plot requests. When an EOF is read, control is transferred to the terminal. In a production or batch situation, end the file with an END command to prevent transfer of control. Never end the COM file with a blank line. If COM is absent, the terminal is used as the source of plot requests. |
| PLOTM=aaaa  | Name the graphics metafile aaaa. The default name is PLOTM. For some systems (see Table B-1) this metafile is a standard postscript file and is named PLOTM.PS. When CGS is being used, there can be no more than six characters in aaaa.  |
| COMOUT=aaaa | Write all plot requests to file aaaa. The default name is COMOUT. MCNP writes the COMOUT file in order to give the user the  |

## APPENDIX B

### THE PLOT GEOMETRY PLOTTER

opportunity to do the same plotting at some later time, using all or part of the old COMOUT file as the COM file in the second run.

Unique names for the output files, PLOTM and COMOUT, will be chosen by MCNP to avoid overwriting existing files.

MCNP can be run in a batch environment without much difficulty, but the user interaction with the plotter is significantly reduced. If you are not using an interactive graphics terminal, use the NOTEK option on the MCNP execution line or set TERM=0 along with other PLOT commands when first prompted by PLOT. Every view you plot will be put in a local graphics metafile or postscript file called PLOTn where n begins at M and goes to the next letter in the alphabet if PLOTM exists. In the interactive mode, plots can be sent to this graphics metafile with the FILE keyword (see the keyword description in section B for a complete explanation.) At Los Alamos, the metafile can be sent to various hard copy devices with PPAGES. For some graphics systems (see Table B-1), the PLOTn.PS file is a postscript file that can be sent to a postscript printer.

A plot request consists of a sequence of commands terminated by a carriage return. A command consists of a keyword, usually followed by some parameters. Lines can be continued by typing an & before the carriage return but each keyword and its parameters must be complete on one line. Keywords and parameters are blank-delimited, no more than 80 characters per line. Commas and equal signs are interpreted as blanks. Keywords can be shortened to any degree not resulting in ambiguity but must be spelled correctly. Parameters following the keywords cannot be abbreviated. Numbers can be entered in free form format and do not require a decimal point for floating point data. Keywords and parameters remain in effect until you change them.

Before describing the individual plotting commands, it may help to explain the mechanics of two-dimensional plotting. To obtain a two-dimensional slice of a geometry, you must decide where the slice should be taken and how much of the slice should be viewed on the terminal screen. The slice is actually a two-dimensional plane that may be arbitrarily oriented in space; therefore, the first problem is to decide the plane position and orientation. In an orthogonal three-dimensional coordinate system the three axes are perpendicular to each other. An orthogonal axis system is defined with a set of BASIS vectors on the two-dimensional plane used to slice the geometry to determine the plot orientation. The first BASIS vector is the horizontal direction on the screen. The second BASIS vector is the vertical direction on the screen. The surface normal for the plane being viewed is perpendicular to the two BASIS vectors.

How much of the slice to view is determined next. The center of the view plane is set with ORIGIN, which serves two purposes: first, for planes not corresponding to simple coordinate planes, it determines the position of the plane being viewed, and second, the origin becomes the center of the cross-sectional slice being viewed. For example, for a Y-Z plot, the X-coordinate given with the PX command determines the location of the PX plane. The ORIGIN is given as an X, Y, and Z coordinate and is the center of the plot displayed. Because planes are infinite and only a finite area

can be displayed at any given time, you must limit the extent of the cross-sectional plane being displayed with the EXTENT command. For instance, a plane defined with  $PX=X_1$  at an ORIGIN of  $X_1, Y_1,$  and  $Z_1$  would produce a Y-Z plane at  $X=X_1$ , centered at  $Y_1$  and  $Z_1$  using the default BASIS vectors for a PX plane of 0 1 0 and 0 0 1. If the EXTENT entered is  $Y_2$  and  $Z_2$ , the plot displayed would have a horizontal extent from  $Y_1 - Y_2$  to  $Y_1 + Y_2$  and a vertical extent of  $Z_1 - Z_2$  to  $Z_1 + Z_2$ .

The BASIS vectors are arbitrary vectors in space. This may seem confusing to the new user, but the majority of plots are PX, PY, or PZ planes where the BASIS vectors are defaulted. For the majority of geometry plots, these simple planes are sufficient and you do not have to enter BASIS vectors.

All the plot parameters for the MCNP plotter have defaults. You can respond to the first MCNP prompt with a carriage return and obtain a plot. The default plot is a PX plane centered at 0,0,0 with an extent of -100 to +100 on Y and -100 to +100 on Z. The Y axis will be the horizontal axis of the plot, and the Z axis will be the vertical axis. Surface labels are printed. This default is the equivalent of entering the command line:

```
origin 0 0 0 extent 100 100 basis 0 1 0 0 0 1 label 1 0
```

By resetting selected plot parameters, you can obtain any desired plot. Most parameters remain set until you change them, either by the same command with new values or by a conflicting command.

*Warning:* Placing the plot plane exactly on a surface of the geometry is not a good idea. Several things can result. Some portion of the geometry may be displayed in dotted lines, which usually indicates a geometry error. Some portion of the geometry may simply not show up at all. Very infrequently the code may crash with an error. To prevent all these unpleasantries, move the plot plane some tiny amount away from surfaces.

## ***B. Plot Commands Grouped by Function***

This section is a detailed description of each of the PLOT keywords and its parameters. You only have to type enough of the keyword so that it is unique but as much as you type must be spelled correctly. The parameters must be typed in full as given here.

### **1. Device-control Commands**

Normally PLOT draws plots on the user's terminal and nowhere else. By means of the following commands the user can specify that plots not be drawn on his terminal and/or that they be sent to a graphics metafile or postscript file for processing later by a graphics utility program that will send the plots to other graphics devices.

**APPENDIX B**  
**THE PLOT GEOMETRY PLOTTER**

TERM n m		The first parameter of this command sets the output device type. Values for this parameter are not consistent from one graphics vendor to another. The n parameter is not used with any graphics systems other than those shown below. The following values are allowed for n:
	0	terminal with no graphics capability. No plots will be drawn on the terminal, and all plots will be sent to the graphic metafile. TERM 0 is equivalent to putting NOTEK on MCNP's execute line.
	1	Tektronix 4010 using CGS.
	2	Tektronix 4014 using CGS.
	3	Tektronix 4014E using CGS. This is the default.
	4115	Tektronix using GKS and UNICOS. This is the default.
	1	Tektronix using the AIX PHIGS GKS library. This is the default. Check with your vendor for the proper terminal type if you are using a GKS library.
		The optional parameter m is the baud rate of the terminal. The default value is 9600.
FILE aa		Send or don't send plots to the graphics metafile PLOTM or postscript file PLOTM.PS according to the value of the parameter aa. The graphics metafile is not created until the first FILE command is entered. FILE has no effect in the NOTEK or TERM~0 cases. The allowed values of aa are:
	blank	only the current plot is sent to the graphics metafile.
	ALL	the current plot and all subsequent plots are sent to the metafile until another FILE command is entered.
	NONE	the current plot is not sent to the metafile nor are any subsequent plots until another FILE command is entered.
VIEWPORT aa		Make the viewport rectangular or square according to the value of aa. The default is RECT. This option does not affect the appearance of the plot. It only determines whether space is provided beside the plot for a legend and around the plot for scales. The allowed values of aa are:
	RECT	allows space beside the plot for a legend and around the plot for scales.
	SQUARE	the legend area, the legend and scales are omitted, making it possible to print a sequence of plots on some sort of strip medium so as to produce one long picture free from interruptions by legends.

2. General Commands

&	Continue reading commands for the current plot from the next input line. The & must be the last thing on the line.
RETURN	If PLOT was called by MCPLLOT, control returns to MCPLLOT. Otherwise RETURN has no effect.
MCPLLOT	Call or return to MCPLLOT.

PAUSE n Use with COM=aaaa option. Hold each picture for n seconds. If no n value is provided, each picture remains until the return key is pressed.  
 END Terminate execution of PLOT.

### 3. Inquiry Commands

When one of these commands is encountered, the requested display is made and then PLOT waits for the user to enter another line, which can be just a carriage return, before resuming. The same thing will happen if PLOT sends any kind of warning or comment to the user as it prepares the data for a plot.

OPTIONS Display a list of the PLOT command keywords and available colors.  
 or ? or HELP  
 STATUS Display the current values of the plotting parameters.

### 4. Plot Commands

Plot commands define the values of the parameters used in drawing the next plot. Parameters entered for one plot remain in effect for subsequent plots until they are overridden, either by the same command with new values or by a conflicting command.

BASIS  $X_1 Y_1 Z_1 \quad X_2 Y_2 Z_2$   
 Orient the plot so that the direction  $(X_1 Y_1 Z_1)$  points to the right and the direction  $(X_2 Y_2 Z_2)$  points up. The default values are 0 1 0 0 0 1, causing the Y-axis to point to the right and the Z-axis to point up.

ORIGIN VX VY VZ  
 Position the plot so that the origin, which is in the middle of the plot, is at the point (VX,VY,VZ). The default values are 0 0 0.

EXTENT EH EV  
 Set the scale of the plot so that the horizontal distance from the origin to either side of the plot is EH and the vertical distance from the origin to the top or bottom is EV. If EV is omitted, it will be set equal to EH. If EV is not equal to EH, the plot will be distorted. The default values are 100 and 100.

PX VX  
 Plot a cross section of the geometry in a plane perpendicular to the X-axis at a distance VX from the origin. This command is a shortcut equivalent of BASIS 0 1 0 0 0 1 ORIGIN VX vy vz, where vy and vz are the current values of VY and VZ.

PY VY  
 Plot a cross section of the geometry in a plane perpendicular to the Y-axis at a distance VY from the origin.

PZ VZ  
 Plot a cross section of the geometry in a plane perpendicular to the Z-axis at a distance VZ from the origin.

LABEL S C DES



## APPENDIX B

### THE PLOT GEOMETRY PLOTTER

Put labels of size *S* on the surfaces and labels of size *C* in the cells. Use the quantity indicated by *DES* for the cell labels. *C* and *DES* are optional parameters. The sizes are relative to 0.01 times the height of the view surface. If *S* or *C* is zero, that kind of label will be omitted. If *S* or *C* is not zero, it must be in the range from 0.2 to 100. The defaults are *S*=1, *C*=0 and *DES*=*CEL*. The values of *DES* follow, where “:p” can be :N for neutrons, :P for photons and :E for electrons.

<i>CEL</i>	cell names
<i>IMP:p</i>	importances
<i>RHO</i>	atom density
<i>DEN</i>	mass density
<i>VOL</i>	volume
<i>FCL:p</i>	forced collision
<i>MAS</i>	mass
<i>PWT</i>	photon--production weight
<i>MAT</i>	material number
<i>TMPn</i>	temperature (n=index of time)
<i>WWNn:p</i>	weight window lower bound (n=energy interval)
<i>EXT:p</i>	exponential transform
<i>PDn</i>	detector contribution (n=tally number)
<i>DXC:p</i>	DXTRAN contribution
<i>U</i>	universe
<i>LAT</i>	lattice type
<i>FILL</i>	filling universe
<i>NONU</i>	fission turnoff
<i>LEVEL n</i>	Plot only the nth level of a repeated structure geometry. A negative entry (default) plots the geometry at all levels.
<i>MBODY</i>	on display only the macrobody surface number. This is the default. off display the macrobody surface facet numbers.
<i>SCALES n</i>	Put scales and a grid on the plot. Scales and grids are incompatible with <i>VIEWPORT SQUARE</i> . <i>n</i> can have the following values: 0 neither scales nor a grid. This is the default. 1 scales on the edges. 2 scales on the edges and a grid on the plot.
<i>COLOR n</i>	Turn color on or off and set the resolution. <i>n</i> can have the following values: on turn color on. off turn color off.
$50 \leq n \leq 3000$	set the color resolution to <i>n</i> . A larger value increases resolution and drawing time.
<i>SHADE</i>	$M_1 = \text{parameter}$ $M_2 = \text{parameter}$ ... Make the cells containing problem material number $M_i$ a particular color. Use the <i>LABEL</i> command to display material numbers. Parameter designates the desired color (e.g., green, blue, etc.). <i>OPTIONS</i> will list available colors if your display is a color monitor.

See page B-1 for supported graphics systems.

5. Zoom Commands

Zoom commands redefine the origin, basis and extent relative to the current origin, basis and extent. The new origin, basis and extent will be used for all subsequent plots until they are again redefined, either by zoom commands or by plot commands. The zoom commands are usually used to zoom in on some feature of the plot.

CENTER	DH DV	Change the origin of the plot by the amount DH in the horizontal direction and by the amount DV in the vertical direction. This command is usually used to define the center of a portion of the current plot that the user wants to enlarge.
FACTOR	F	Enlarge the plot by the factor 1/F. F must be greater than $10^{-6}$ .
THETA	TH	Rotate the plot counterclockwise by the angle TH, in degrees.
CURSOR		Present the graphics cursor and prepare to receive cursor input from the user. This command is available only if the terminal has a graphics cursor capability. The user defines a rectangular area to be enlarged by moving the cursor to one corner of the rectangle and entering the cursor trigger, then moving it to the diagonally opposite corner of the rectangle and entering the cursor trigger again. On most terminals the cursor trigger is any key other than the carriage return followed by a carriage return. If the extents were equal before the cursor command was entered, the smaller of the two extents defined by the cursor input is made equal to the larger one. The CURSOR command should be the only command on the input line.
RESTORE		Restore the origin and extent to the values they had before the most recent CURSOR command. The RESTORE command should be the only command on the input line. It cannot be used to undo the effects of the CENTER, FACTOR and THETA commands.
LOCATE		Present the graphics cursor and prepare to receive cursor input from the user. This command is available only if the terminal has a graphics cursor capability. The user moves the cursor to a point in the picture and enters the cursor trigger. The x,y,z coordinates of the point are displayed. The LOCATE command should be the only command on the input line.

**C. *Geometry Debugging and Plot Orientation***

Surfaces appearing on a plot as dashed lines usually indicate that adjoining space is improperly defined. Dashed lines caused by a geometry error can indicate space that has been defined in more than one cell or space that has never been defined. These geometry errors need to be corrected. Dashed lines can occur because the plot plane corresponds to a bounding planar surface. The plot plane should be moved so it is not coincident with a problem surface. Dashed lines can indicate a

## APPENDIX B

### THE MCNPLOT TALLY AND CROSS SECTION PLOTTER

cookie cutter cell or a DXTRAN sphere. These are not errors. The reason for the presence of dashed lines on an MCNP plot should be understood before running a problem.

When checking a geometry model, errors may not appear on the two-dimensional slice chosen, but one or more particles will get lost in tracking. To find the modeling error, use the coordinates and trajectory of the particle when it got lost. Entering the particle coordinates as the ORIGIN and the particle trajectory as the first basis vector will result in a plot displaying the problem space.

The ORIGIN, EXTENT, and BASIS vectors all define a space called the plot *window* (in particular, the window that appears on the terminal screen). The window is a rectangular plane twice the length and width of EXTENT, centered about the point defined by ORIGIN. The first BASIS vector B1 is along the horizontal axis of the plot window and points toward the right side of the window. The second BASIS vector B2 is along the vertical axis of the plot window and points toward the top of the window.

The signs are determined by the direction of the vectors; in particular, do the vector components point in the  $\pm x$ ,  $\pm y$ , or  $\pm z$  direction? After signs have been fixed, determine the magnitudes of the vector components. Assume the vector is parallel to the x-axis. It has no y-component and no z-component so the vector would be 1 0 0. If there is no x-component but both y and z, and y and z have equal magnitudes, the vector would be 0 1 1. The vector does not have to be normalized. If the angle between the vector and the axes is known, the user can use the sine and cosine of the angle to determine the magnitude of the components. A rough approximation will probably be sufficient.

### III. THE MCNPLOT TALLY AND CROSS SECTION PLOTTER

MCNPLOT plots tally results produced by MCNP and cross-section data used by MCNP. It can draw ordinary two-dimensional x-y plots, contour tally plots, and three-dimensional surface tally plots, and supports a wide variety of plot options. More than one curve can be plotted on a single x-y plot.

MCNPLOT plots cross-section data specified in an INP file: either individual nuclides or the complete material composed of constituent nuclei properly weighted by atomic fraction. The data plotted reflect adjustments to the cross sections made by MCNP such as energy cutoffs, neutron cross-section temperatures,  $S(\alpha,\beta)$  treatment, summation of photon reactions to provide a total photon cross section, simple physics treatment for photon data, generation of electron stopping powers and other electron data, and more. Cross-section plots can not be made from a RUNTPE file.

This section covers these general topics in the following order: execute line options, plot conventions and command syntax, plot commands grouped by function, and MCTAL files. MCNPLOT options and keywords are shown in upper case but are usually typed by the user in lower case.

## APPENDIX B

### THE MCNPLOT TALLY AND CROSS SECTION PLOTTER

Final tally results can be plotted after particle transport has finished. The temporary status of one or more tallies can be displayed during the run as transport is ongoing. After transport is finished, MCNPLOT is invoked by typing a **z** on the MCNP execute line, either as a separate procedure using existing RUNTPE or MCTAL files or as part of a regular uninterrupted MCNP run. There are two ways to request that a plot be produced periodically during the run: use a MPLOT card in the INP file or use the TTY interrupt feature. See Chapter 3 for an explanation of the MPLOT card. A TTY interrupt `< ctrl-c >` causes MCNP to pause at the end of the history that is running when the interrupt occurs and allows plots to be made by calling MCNPLOT, which takes plot requests from the terminal. No output is sent to the COMOUT file. The following commands can not be used: RMCTAL, RUNTPE, DUMP and END. Cross-section data cannot be displayed after a TTY interrupt or by use of the MPLOT card.

MCNPLOT can make tally plots on a machine different from the one on which the problem was run by using the MCTAL file. When the INP file has a PRDMP card with a nonzero third entry, a MCTAL file is created at the end of the run. The MCTAL file contains all the tally data in the last RUNTPE dump and it is a coded ASCII file that can be converted and moved from one kind of machine to another. When the MCTAL file is created, its name can be specified by:  
`mcnp i=inpfile mctal=filename` in the execute line. The default name is a unique name based on MCTAL.

#### A. *Input for MCNPLOT and Execution Line Options*

To run only MCNPLOT and plot tallies after termination of MCNP, enter the following command:

```
mcnp z options
```

where ‘z’ invokes MCNPLOT. “Options” is explained in the next paragraph. Cross-section data cannot be plotted by this method.

The execute line command

```
mcnp inp= filename ixrz options
```

causes MCNP to run the problem specified in *filename* and then the prompt *mcplot >* appears for MCNPLOT commands. Both cross-section data and tallies can be plotted. Cross-section data cannot be plotted after a TTY interrupt or by use of the MPLOT card.

The execute line command

```
mcnp inp= filename ixz options
```

is the most common way to plot cross-section data. The problem cross sections are read in but no transport occurs. The following commands cannot be used: 3D, BAR, CONTOUR, DUMP, FREQ, HIST, PLOT, RETURN, RMCTAL, RUNTPE, SPLINE, VIEW, and WMCTAL.

The following options can be entered on the execution line:

## APPENDIX B

### THE MCNPLOT TALLY AND CROSS SECTION PLOTTER

- NOTEK Suppress plotting at the terminal and send all plots to the graphics metafile, PLOTM. NOTEK is for production and batch situations and for when the user's terminal has no graphics capability.
- COM=aaaa Use file aaaa as the source of plot requests. When an EOF is read, control is transferred to the terminal. In a production or batch situation, end the file with an END command to prevent transfer of control. Never end the COM file with a blank line. If COM is absent, the terminal is used as the source of plot requests.
- RUNTPE=aaaa Read file aaaa as the source of MCNP tally data. The default is RUNTPE, if it exists. If the default RUNTPE file does not exist, the user will be prompted for an RMCTAL or RUNTPE command.
- PLOTM=aaaa Name the graphics metafile aaaa. The default name is PLOTM. For some systems (see Table B-1) this metafile is a standard postscript file and is named PLOTM.PS. When CGS is being used, there can be no more than six characters in aaaa.
- COMOUT=aaaa Write all plot requests to file aaaa. The default name is COMOUT. MCNPLOT writes the COMOUT file in order to give the user the opportunity to do the same plotting at some later time, using all or part of the old COMOUT file as the COM file in the second run.

Unique names for the output files, PLOTM and COMOUT, will be chosen by MCNP to avoid overwriting existing files.

Plot requests are normally entered from the keyboard of a terminal but alternatively can be entered from a file. A plot is requested by entering a sequence of plot commands following a prompt character. The request is terminated by a carriage return not immediately preceded by an & or by a COPLOT command. Commands consist of keywords, usually followed by some parameters, entered space or comma delimited.

Defaults are available for nearly everything. If MCNP is run with Z as the execute line message, and if file RUNTPE is present with more than one energy bin in the first tally, and if a carriage return is entered in response to the MCNPLOT prompt, a lin-log histogram plot of tally/MeV vs. energy, with error bars and suitable labels, will appear on the screen.

#### ***B. Plot Conventions and Command Syntax***

##### ***1. 2D plot***

The origin of coordinates is at the lower left corner of the picture. The horizontal axis is called the x axis. It is the axis of the independent variable such as user bin or cell number or energy. The vertical axis is called the y axis. It is the axis of the dependent variable such as flux or current or dose. Each axis can be either linear or logarithmic.

2. Contour plot

The origin of coordinates is at the lower left corner of the picture. The horizontal axis is called the x axis. It is the axis of the first of the two independent variables. The vertical axis is called the y axis. It is the axis of the second independent variable. The contours represent the values of the dependent variable. Only linear axes are available.

3. Command syntax

Each command consists of a command keyword, in most cases followed by some parameters. Keywords and parameters are entered blank delimited, no more than 80 characters per line. Commas and equal signs are interpreted as blanks. A plot request can be continued onto another line by typing an & before the carriage return, but each command (the keyword and its parameters) must be complete on one line. Command keywords, but not parameters, can be abbreviated to any degree not resulting in ambiguity but must be correctly spelled. The term “current plot” means the plot that is being defined by the commands currently being typed in, which might not be the plot that is showing on the screen. Only those commands marked with an \* in the list in section C can be used after the first CO PLOT command in a plot request because the others all affect the framework of the plot or are for contour or 3D plots only.

**C. *Plot Commands Grouped by Function***

1. Device-control Commands

Normally MC PLOT draws plots on the user’s terminal and nowhere else. By means of the following commands the user can specify that plots not be drawn on his terminal and/or that they be sent to a graphics metafile or postscript file for processing later by a graphics utility program that will send the plots to other graphics devices.

TERM n m    The first parameter of this command sets the output device type. Values for this parameter are not consistent from one graphics vendor to another. The n parameter is not used with any graphics systems other than those shown below. The following values are allowed for n:

0	for a terminal with no graphics capability. No plots will be drawn on the terminal, and all plots will be sent to the graphics metafile. TERM 0 is equivalent to putting NOTEK on MCNP’s execute line.
1	Tektronix 4010 using CGS.
2	Tektronix 4014 using CGS.
3	Tektronix 4014E using CGS. This is the default.
4115	Tektronix using GKS and UNICOS. This is the default.
1	Tektronix using the AIX PHIGS GKS library. This is the default.

## APPENDIX B

### THE MC PLOT TALLY AND CROSS SECTION PLOTTER

Check with your vendor for the proper terminal type if you are using a GKS library.

The optional parameter m is the baud rate of the terminal. The default value is 9600.

FILE aa      Send or don't send plots to the graphics metafile PLOTM or postscript file PLOTM.PS according to the value of the parameter aa. The graphics metafile is not created until the first FILE command is entered. FILE has no effect in the NOTEK or TERM 0 cases. The allowed values of aa are:

blank      only the current plot is sent to the graphics metafile.  
ALL        the current plot and all subsequent plots are sent to the metafile until another FILE command is entered.  
NONE      the current plot is not sent to the metafile nor are any subsequent plots until another FILE command is entered.

#### 2. General Commands

\* &            Continue reading commands for the current plot from the next input line. The & must be the last thing on the line.

\* CO PLOT     Plot a curve according to the commands entered so far and keep the plot open for coplotting one or more additional curves. CO PLOT is effective for 2D plots only. If CO PLOT is the last command on a line, it functions as if it were followed by an &.

FREQ n        Specifies the interval between calls to MC PLOT to be every n histories. In KCODE calculation, interval is every n cycles. If n is negative, the interval is in CPU minutes. If n=0, MC PLOT is not called while MCNP is running histories. The default is n=0.

RETURN        If MC PLOT was called by MCNP while running histories or by PLOT while doing geometry plotting, control returns to the calling subroutine. Otherwise RETURN has no effect.

PLOT          Call or return to the PLOT geometry plotter.

PAUSE n       Use with COM=aaaa option. Hold each picture for n seconds. If no n value is provided, each picture remains until the return key is pressed.

\* END         Terminate execution of MC PLOT.

\* = available with CO PLOT

#### 3. Inquiry Commands

When one of these commands is encountered, the requested display is made and then MC PLOT waits for the user to enter another line, which can be just a carriage return, before resuming. The same thing will happen if MC PLOT sends any kind of warning or comment to the user as it prepares the data for a plot.

\* OPTIONS     Display a list of the MC PLOT command keywords.

**APPENDIX B**  
**THE MCPLLOT TALLY AND CROSS SECTION PLOTTER**

- \* or ? or HELP
- \* STATUS     Display the current values of the plotting parameters.
- \* PRINTAL    Display the numbers of the tallies in the current RUNTPE or MCTAL file.
- \* IPTAL      Display the IPTAL array for the current tally. This array (see Appendix E) tells how many elements are in each dimension of the current 8–dimensional tally.
- PRINTPTS   Display the x–y coordinates of the points in the current plot. PRINTPTS is not available for coplots or contour or 3D plots.
- \* = available with COPLOT

4. File Manipulation Commands

- \* RUNTPE aa n   Read dump n from RUNTPE file aa. If the parameter n is omitted, the last dump in the file is read.
- \* DUMP n        Read dump n of the current RUNTPE file.
- \* WMCTAL aa    Write the tally data in the current RUNTPE dump to MCTAL file aa.
- \* RMCTAL aa    Read MCTAL file aa.
- \* = available with COPLOT

5. Parameter–setting Commands

Parameters entered for one curve or plot remain in effect for subsequent curves and plots until they are either reset to their default values with the RESET command or are overridden, either by the same command with new values, by a conflicting command, or by the FREE command that resets many parameters. There are two exceptions: FACTOR and LABEL are effective for the current curve only. An example of a conflicting command is BAR, which turns off HIST, PLINEAR, and SPLINE.

a. General

- \* TALLY n      Define tally n as the current tally. n is the n on the Fn card in the INP file of the problem represented by the current RUNTPE or MCTAL file. The default is the first tally in the problem, which is the lowest numbered neutron tally or, if none, then the lowest numbered photon tally or, if none, then the lowest numbered electron tally.
- \* PERT n      Plot a perturbation associated with a tally, where n is a number on a PERTn card. PERT 0 will reset PERT n.
- NONORM       Suppress bin normalization. The default in a 2D plot is to divide the tallies by the bin widths if the independent variable is cosine, energy, or time. However, also see the description of the MCTAL file in section B.II.D. Bin normalization is not done in 3D or contour plots.
- \* FACTOR a f s   Multiply the data for axis a by the factor f and then add the term s. a is x, y, or z. s is optional. If s is omitted, it is set to zero. For the initial curve of a 2D plot, reset



## APPENDIX B

### THE MCPLOT TALLY AND CROSS SECTION PLOTTER

the axis limits (XLIMS or YLIMS) to the default values. FACTOR affects *only* the current curve or plot.

- \* RESET aa Reset the parameters of command aa to their default values. aa can be a parameter-setting command, COPLOT, or ALL. If aa is ALL, the parameters of all parameter-setting commands are reset to their default values. After a COPLOT command, only COPLOT, ALL, or any of the parameter-setting commands that are marked with an \* in this list may be reset. Resetting COPLOT or ALL while COPLOT is in effect causes the next plot to be an initial plot.

\* = available with COPLOT

#### b. Titling commands. The double quotes are required.

TITLE n "aa" Use aa as line n of the main title at the top of the plot. The allowed values of n are 1 and 2. The maximum length of aa is 40 characters. The default is the comment on the FC card for the current tally, if any. Otherwise it is the name of the current RUNTPE or MCTAL file plus the name of the tally. KCODE plots have their own special default title.

BELOW Put the title below the plot instead of above it. BELOW has no effect on 3D plots.

SUBTITLE x y "aa" Write subtitle aa at location x,y, which can be anywhere on the plot including in the margins between the axes and the limits of the screen.

XTITLE "aa" Use aa as the title for the x axis. The default is the name of the variable represented by the x axis.

YTITLE "aa" Use aa as the title for the y axis. The default is the name of the variable represented by the y axis.

ZTITLE "aa" Use aa as the title for the z axis in 3D plots. The default is the name of the variable represented by the z axis.

\* LABEL "aa" Use aa as the label for the current curve. It is printed in the legend beside a short piece of the kind of line used to plot the curve. The value of LABEL reverts to its default value, blank, after the current curve is plotted. If LABEL is blank, the name of the RUNTPE or MCTAL file being plotted is printed as the label for the curve.

\* = available with COPLOT

#### c. Commands that specify what is to be plotted.

Tallies in MCNP are binned according to the values of eight different independent variables. Because only one or two of those variables can be used as independent variables in any one plot, one or two of the eight independent variables have to be designated as free variables, and the rest become fixed variables. Fixed values (bin numbers) have to be defined, explicitly or by default, for all of the fixed variables. The default value for each fixed variable is the first bin unless a total bin exists in which case it is used instead.

**APPENDIX B**  
**THE MC PLOT TALLY AND CROSS SECTION PLOTTER**

- FREE xy** Use variable x (y blank) or variables x and y as the independent variable or variables in the plot. If only x is specified, 2D plots are made. If both x and y are specified, either contour or 3D plots are made, depending on whether 3D is in effect. See keyword **FIXED** for the list of the symbols that can be used for x and y. The default value of xy is E, and gives a 2D plot in which the independent variable is energy. The **FREE** command resets **XTITLE**, **YTITLE**, **ZTITLE**, **XLIMS**, **YLIMS**, **HIST**, **BAR**, **PLINEAR**, and **SPLINE** to their defaults.
- \* FIXED q n** Set n as the bin number for fixed variable q. The symbols that can be used for q, and the kinds of bins they represent are:  
**F** cell, surface, or detector  
**D** total vs. direct or flagged vs. unflagged  
**U** user-defined  
**S** segment  
**M** multiplier  
**C** cosine  
**E** energy  
**T** time
- SET f d u s m c e t**  
Define which variables are free and define the bin numbers of the fixed variables. **SET** does the job of the **FREE** and several **FIXED** commands in one compact command. The value of each parameter can be a bin number (the corresponding variable is then a fixed variable) or an \* (the corresponding variable is then a free variable). If there is only one \*, 2D plots are made. If there are two, contour or 3D plots are made. **SET** does the same resetting of parameters that **FREE** does.
- TFC x** Plot the tally fluctuation chart of the current tally. The independent variable is NPS. Allowed values of x are:  
**M** mean  
**E** relative error  
**F** figure of merit  
**L** 201 largest tallies vs x  
(NONORM for frequency vs x)  
**N** cumulative number fraction of  $f(x)$  vs x  
**P** probability  $f(x)$  vs x  
(NONORM for number frequency vs x)  
**S** SLOPE of the high tallies as a function of NPS  
**T** cumulative tally fraction of  $f(x)$  vs x  
**V** VOV as a function of NPS  
**1-8** 1 to 8 moments of  $f(x)*x^{1to8}$  vs x  
(NONORM for  $f(x)*\Delta x * x^{1to8}$  vs x)  
**1c-8c** 1 to 8 cumulative moments of  $f(x)*x^{1to8}$  vs x

## APPENDIX B

### THE MCPLLOT TALLY AND CROSS SECTION PLOTTER

- \* KCODE i The independent variable is the KCODE cycle. The individual estimator plots start with cycle one. The average col/abs/trk-len plots start with the fourth active cycle.
- Plot  $k_{eff}$  or removal lifetime according to the value of i:
- 1 k (collision)
  - 2 k (absorption)
  - 3 k (track)
  - 4 prompt removal lifetime (collision)
  - 5 prompt removal lifetime (absorption)
  - 11–15 the quantity corresponding to i–10, averaged over the cycles so far in the problem.
  - 16 average col/abs/trk-len  $k_{eff}$  and one estimated standard deviation
  - 17 average col/abs/trk-len  $k_{eff}$  and one estimated standard deviation by cycle skipped. Can not plot fewer than 10 active cycles.
  - 18 average col/abs/trk-len  $k_{eff}$  figure of merit
  - 19 average col/abs/trk-len  $k_{eff}$  relative error
- \* = available with COPLOT

#### d. Commands for cross section plotting.

- \* XS m Plot a cross section according to the value of m:
- Mn a material card in the INP file. Example: XS M15. The available materials will be listed if a material is requested that does not exist in the INP file.
  - z a nuclide ZAID. Example: XS 92235.50C. The full ZAID must be provided. The available nuclides will be listed if a nuclide is requested that does not exist in the INP file.
  - ? Print out a cross section plotting primer.
- \* MT n Plot reaction n of material XS m. The default is the total cross section. The available reaction numbers are listed in Appendix G Section I page G–1. If an invalid reaction number is requested, the available reactions in the data file will be listed.
- \* PAR p Plot the data for particle type p, where p can be n, p, or e of material Mn. The default is the source particle type for XS=Mn. For XS=z, the particle type is determined from the data library type. For example, 92000.01g defines PAR=p. Must be first entry on line.
- \* = available with COPLOT

#### e. Commands that specify the form of 2D plots.

- LINLIN Use linear x axis and linear y axis.
- LINLOG Use linear x axis and logarithmic y axis. This is the default.
- LOGLIN Use logarithmic x axis and linear y axis.
- LOGLOG Use logarithmic x axis and logarithmic y axis.

**APPENDIX B**  
**THE MCPLLOT TALLY AND CROSS SECTION PLOTTER**

XLIMS min max nsteps

YLIMS min max nsteps

Define the lower limit, upper limit, and number of subdivisions on the x or y axis. nsteps is optional for a linear axis and is ineffective for a logarithmic axis. In the absence of any specification by the user, the values of min, max, and nsteps are defined by an algorithm in MCNP.

SCALES n Put scales on the plots according to the value of n:

0 no scales on the edges and no grid.

1 scales on the edges (the default).

2 scales on the edges and a grid on the plot.

\* HIST Make histogram plots. This is the default if the independent variable is cosine, energy, or time.

\* PLINEAR Make piecewise-linear plots. This is the default if the independent variable is not cosine, energy, or time.

\* SPLINE x Use spline curves in the plots. If the parameter x is included, rational splines of tension x are plotted. Otherwise Stineman cubic splines are plotted. Rational splines are available only with the DISSPLA graphics system.

\* BAR Make bar plots.

\* NOERRBAR Suppress error bars. The default is to include error bars.

\* THICK x Set the thickness of the plot curves to the value x. The legal values lie in the range from 0.01 to 0.10. The default value of THICK is 0.02.

\* THIN Set the thickness of the plot curves to the legal minimum of 0.01.

LEGEND x y Include or omit the legend according to the values of optional parameters x and y. no x and no y: put the legend in its normal place. (the default).  
x=0 and no y: omit the legend.

x and y defined: for 2D plots only, put most of the legend in its usual place but put the part that labels the plot lines at location x,y.

\* = available with COPLOT

f. Commands that specify the form of contour plots.

CONTOUR cmin cmax cstep %

Define cmin, cmax, and cstep as the minimum, maximum, and step values for contours. If the optional % symbol is included, the first three parameters are interpreted as percentages of the minimum and maximum values of the dependent variable. The default values are 5 95 10 %

## APPENDIX B THE MCNPLOT TALLY AND CROSS SECTION PLOTTER

### D. MCTAL Files

A MCTAL file contains the tally data of one dump of a RUNTPE file. It can be written by the MCRUN module of MCNP or by the MCNPLOT module, by other codes, or even by hand in order to send data to MCNPLOT for coplotting with MCNP tally data.

As written by MCNP, a MCTAL file has the form shown below, but only as much of it as is essential to contain the information of real substance is necessary. Furthermore the numerical items do not need to be in the columns implied by the formats as long as they are in the right order, are blank delimited, and have no imbedded blanks. For example, to give MCNPLOT a table of something versus energy, the user might write a file as simple as:

```
E   7   1
     .2  .4  .7  1  3  8  12
VALS
     4.00E-5 .022  5.78E-4 .054  3.70E-5 .079  1.22E-5 .122
     7.60E-6 .187  2.20E-6 .245  9.10E-7 .307
```

If more than one independent variable is wanted, other lines such as a T line followed by a list of time values would be needed and the table of tally/error values would need to be expanded. If more than one table of tally/error values is wanted, the file would have to include an NTAL line followed by a list of arbitrarily chosen tally numbers, a TALLY line, and lines to describe all of the pertinent independent variables would have to be added for each table.

Form of the MCTAL file as written by MCNP.

kod, ver, probid, knod, nps, rnr (2A8,A19,15,I11,I15)

kod is the name of the code, MCNP.

ver is the version, 4A.

probid is the date and time when the problem was run and, if it is available,  
the designator of the machine that was used.

knod is the dump number.

nps is the number of histories that were run.

rnr is the number of pseudorandom numbers that were used.

One blank followed by columns 1–79 of the problem identification line, which is the first line in the problem's INP file. (1x,A79)

NTAL n NPERT m (A4,I6,1X,A5,I6)

n is the number of tallies in the problem.

m is the number of perturbations in the problem.

List of the tally numbers, on as many lines as necessary. (16I5)

The following information is written for each tally in the problem.

**APPENDIX B**

**THE MCPLLOT TALLY AND CROSS SECTION PLOTTER**

TALLY m i	(A5,2I5)
m is the problem name of the tally, one of the numbers in the list after the NTAL line.	
i is the particle type: 1=N, 2=P, 3=N+P, 4=E, 5=N+E, 6=P+E, 7=N+P+E, where N=neutron, P=photon, E=electron.	
The FC card lines, if any, each starting with 5 blanks }	(5x,A75)
F n	(A2,I8)
n is the number of cell, surface, or detector bins.	
List of the cell or surface numbers, on as many lines as necessary.	(11I7)
If a cell or surface bin is made up of several cells or surfaces, a zero is written. This list is omitted if the tally is a detector tally.	
D n	(A2,I8)
n is the number of total vs. direct or flagged vs. unflagged bins.	
For detectors, n=2 unless there is an ND on the F5 card; for cell and surface tallies, n=1 unless there is an SF or CF card.	
U n or UT n or UC n	(A2,I8)
n is the number of user bins, including the total bin if there is one.	
But if there is only one unbounded bin, n=0 instead of 1.	
If there is a total bin, the character U at the beginning of the line is followed by the character T. If there is cumulative binning, the character U at the beginning of the line is followed by the character C.	
These conventions concerning a single unbounded bin and the total bin also apply to the S, M, C, E, and T lines below.	
S n or ST n or SC n	(A2,I8)
n is the number of segment bins.	
M n or MT n or MC n	(A2,I8)
n is the number of multiplier bins.	
C n f or CT n f or CC n f	(A2,I8,I4)
n is the number of cosine bins. f is an integer flag: if f=0 or is absent, the cosine values in the list next below are bin boundaries. Otherwise they are the points where the tally values ought to be plotted, and the tally values are not under any circumstances to be divided by the widths of cosine bins. The E and T lines below have similar flags.	
List of cosine values, on as many lines as necessary.	1P6E13.5
E n f or ET n f or EC n f	A2,I8,I4
n is the number of energy bins.	
List of energy values, on as many lines as necessary.	(1P6E13.5)
T n f or TT n f or TC n f	(A2,I8,I4)
n is the number of time bins.	
List of time values, on as many lines as necessary.	(1P6E13.5)
VALS	(A4)
List of tally/error data pairs, on as many lines as necessary.	(4(1PE13.5,0PF7.4))

**APPENDIX B**  
**THE MC PLOT TALLY AND CROSS SECTION PLOTTER**

The order is what a 9-dimensional FORTRAN array would have if it were dimensioned (2,NT,NE,...,NF), where NT is the # of time bins, NE is the # of energy bins, ..., and NF is the # of cell, surface, or detector bins. The values here are exactly the same as are printed for each tally in the OUTF file.

TFC n jtf (A3,I5,8I8)  
 n is the number of sets of tally fluctuation data. jtf is a list of 8 numbers, the bin indexes of the tally fluctuation chart bin.  
 List of four numbers for each set of tally fluctuation chart data, NPS, tally, error, figure of merit. (I11,1P3E13.5)

This is the end of the information written for each tally.

KCODE nc ikz mk (A5,I5)  
 nc is the number of recorded KCODE cycles. ikz is the number of settle cycles. mk is the number of variables provided for each cycle.  
 List of 3  $k_{eff}$  and 2 removal lifetime values for each recorded KCODE cycle (5F12.6)  
 if mk=0 or 5; if mk=19, the whole RKPL(19,MRKP) array is given (see page E-40).

**E. Example of Use of CO PLOT**

runtpe a coplot runtpe b

Assume all parameter-setting commands have been previously defined. The input above will put two curves on one plot. The first curve will display tally data from RUNTPE a and the second curve will display tally data from RUNTPE b for the same tally number. Unless reset somehow, MC PLOT will continue to read from RUNTPE b. Next we might type

xlims min max tally 11 coplot rmctal aux tally 41 &  
 coplot runtpe a tally 1

changing the upper and lower limit of the x-axis, defining tally 11 as the current tally, plotting the first curve from RUNTPE b, the second curve from tally 41 data on MCTAL file aux, and the third curve from tally 1 data on RUNTPE a. Future plots will display data from RUNTPE a unless reset.

tally 24 nonorm file coplot tally 44

will send a frame with two curves to the graphics metafile.

## APPENDIX C

### INSTALLING MCNP ON VARIOUS SYSTEMS

The following topics are addressed in this appendix: MCNP installation, modifying MCNP, MCNP verification, and converting cross-section files.

#### *I. INSTALLING MCNP*

The following files are provided with the MCNP4C distribution:

<u>FILE</u>	<u>DESCRIPTION</u>
Readme	Installation instructions
INSTALL	Installation controller. Named INSTALL.BAT for PC Windows systems
INSTALL.FIX	Installation fix file
MCSETUP.ID	Setup FORTRAN code
PRPR.ID	FORTRAN preprocessor code
MAKXS.ID	Cross-section processor source code
MCNPC.ID	MCNP C source code
MCNPF.ID	MCNP FORTRAN source code
RUNPROB	Script file for MCNP verification. Named RUNPROB.BAT for PC Windows systems
TESTINP.TAR	Compressed input files for MCNP verification Named TESTINP.ZIP for PC Windows systems
TESTMCTL.SYS	Compressed tally output files for MCNP verification Named TESTMCTL.ZIP for PC Windows systems
TESTOUTP.SYS	Compressed MCNP output files for MCNP verification Named TESTOUTP.ZIP for PC Windows systems
TESTDIR	Cross-section directory for MCNP verification
TESTLIB1	Cross-section data for MCNP verification

Substitute the appropriate system identifier from Table C.1 for the “SYS” suffix.

**TABLE C.1:**

<u>SYSTEM</u>	<u>IDENTIFIER</u>	<u>SYSTEM</u>	<u>IDENTIFIER</u>
Cray UNICOS	ucos	DEC Alpha ULTRIX	dec
Sun Solaris	sun	PC Linux	linux
IBM RS/6000 AIX	aix	PC Windows (DVF)	n/a
HP-9000 HPUX	hp	PC Windows (Lahey)	n/a
SGI IRIX	sgi	DEC VMS	vms



## APPENDIX C INSTALLING MCNP

The INSTALL.FIX file is used to implement corrections to either the MCNP source or the MAKEMCNP script. The latter is important for future changes and/or bugs in compilers and/or operating systems. The format of this file is provided within INSTALL.FIX and additional details can be found on page C-11. The MCSETUP utility is a user-friendly interface for creating system dependent files. The remaining files in the first group are MCNP related source code, and the second group of files are used for MCNP verification (i.e., running the 29 MCNP test problems).

For Windows systems, one additional utility is included: the archive utility PKUNZIP.EXE.

The following software/hardware requirements exist:

1. A FORTRAN 77 compiler. The supported compiler for each system is listed in the 1.1 MCSETUP menu (see below). The PC DVF compiler is FORTRAN 90 and the PC Lahey compiler is FORTRAN 95.
2. On Unix systems, a C compiler with an ANSI C library is required for X-Window graphics and dynamic memory allocation options. A Bourne-shell command interpreter is needed to execute the installation script. On PC Windows systems, the Microsoft Visual C++ compiler is required to implement these options.
3. A minimum of 2 Mbytes of RAM (16 Mbytes recommended) and 50 Mbytes of disk space (100 Mbytes recommended).

### A. *On Supported Systems*

The supported systems are those included in Table C.1. Installation on other systems should follow the procedure described in Section I. C on page C-5.

#### 1. Getting Started

To initiate the installation controller, enter the appropriate commands from Table C.2.

**TABLE C.2:**

<u>COMMANDS</u>	<u>COMMENT</u>
chmod a+x install ./install SYS	UNIX systems - SYS keyword given in the table C.1
INSTALL	Windows systems

The MCSETUP utility is initiated first. Alter the main menu according to the MCNP options you desire. Note the following:

1. Default responses are included within brackets, [ ], (i.e., a <CR> will produce the default response) and additional options are included within parentheses.
2. Section 1.1 of the main menu should be altered first because it sets the appropriate computer system with suitable option defaults.
3. If the dynamic memory option is turned “off”, an appropriate value for the MDAS parameter should be set (default is mdas=4000000). In general, MDAS should be greater than 100000 and less than  $(R-2)/4 * 1000000$ , where R is your available RAM in Mbytes.
4. If you are uncertain as to the availability or location of graphics libraries on your system, contact your system administrator. Default library names and directory paths are supplied by the MCSETUP utility; however these may not be applicable to your system. A FATAL error message is displayed if needed libraries can not be located. Included in this message is the expected library name and path.

When done altering the MCSETUP menu, use the PROCESS command to continue the installation. The MCSETUP utility creates three system-dependent files: the PRPR C patch file PATCHC, the PRPR FORTRAN patch file PATCHF, and the MAKEMCNP script. PATCHF and PATCHC include \*define preprocessor directives that reflect the options chosen in the execution of the MCSETUP code. MCSETUP also creates an ANSWER file that contains the MCSETUP input for future installations. This file reflects all options chosen during the initial installation and can be used in future installations by entering the appropriate command from Table C.3.

**TABLE C.3:**

<u>COMMANDS</u>	<u>COMMENT</u>
./install SYS < answer	UNIX systems
INSTALL ANSWER	DOS systems

Next, INSTALL initiates the MAKEMCNP script that creates the MCNP executable. System differences can result in compilation errors such as unsatisfied externals. If errors occur, contact MCNP@LANL.GOV regarding a fix. In many cases a short fix can be added to your INSTALL.FIX file to rectify the situation.

The last section of INSTALL performs MCNP verification by running the 29 MCNP test problems. If this step is to be omitted, rename the RUNPROB file to some other name.

On most dedicated systems, compilation time is roughly 15-30 minutes and verification an additional 20-40 minutes.

## APPENDIX C INSTALLING MCNP

### 2. Upon Completion

A successful compilation generates an MCNP executable called `mcnp` on UNIX systems and `MCNP.EXE` on Windows systems. The MCNP FORTRAN source is placed in the `flib` directory and split into subroutines called `subroutine.f` on UNIX and `subroutine.for` on Windows. The object code is split and placed in the `olib` directory. A normal completion results in the following message:

Installation complete - see Readme file.

A log of the installation process and the cause of an error are written to the `INSTALL.LOG` file. An abnormal completion results in one of the following messages:

SETUP ERROR OR USER ABORT.  
COMPILATION ERROR - see `INSTALL.LOG` file.  
VERIFICATION ERROR - see `INSTALL.LOG` file.

Upon completion of MCNP verification, 29 `difm??` files (`??=01,02,etc.`) will exist containing the MCNP tally differences between your runs and the standard. Similarly, the 29 `difo??` files will contain the MCNP output file differences between your runs and the standard. Exact tracking is required for MCNP verification. Significant differences, that is, other than round-off in the last digit, may prove to be serious (e.g., compiler bugs). In such cases the `INSTALL.LOG` file should be reviewed to ensure that the 29 test problems ran successfully. See Section III on page C-12 for further details.

### **B. VMS System**

On VMS systems, enter the following line in your `LOGIN.COM` file to enable argument passing on the MCNP execution line:

```
MCNP ::= $MCNP\_DISK:[MCNP\_PATH]MCNP.EXE
```

where `MCNP_DISK` and `MCNP_PATH` are the disk and directory path to be used for the MCNP installation. To update this change, log back in or type `@LOGIN`.

To initiate the installation controller, enter `COPY INSTALL.VMS INSTALL.COM@INSTALL`

`MCSETUP` creates an `ANSWER` file that contains the `MCSETUP` input for future installations. This file reflects all options chosen during the initial installation and can be used in future installations by entering `ASSIGN ANSWER.DAT SYS$COMMAND@INSTALL`

A successful compilation generates an MCNP executable called `MCNP.EXE` on VMS. The MCNP FORTRAN source will be called `MCNP.FOR`.

*C. On Other Systems*

For systems not included in Table C.1, the installation process is somewhat more complex, involving three general steps: (1) create a PRPR patch file for MCNP; (2) create PRPR, MAKXSF, and MCNP executables; and (3) execute the 29 MCNP test problems. Discussion for the first two steps follows, while step (3) is discussed in Section III on page C-12.

1. Creating a PRPR Patch File for MCNP

The MCNP source file must be preprocessed before it can be compiled. The preprocessor inserts comdecks and deletes the sections of system dependent code that are not appropriate for your particular computer system. Also the preprocessor can modify MCNP to set a search path for data, to set the maximum size of variably dimensioned storage for machines without dynamic memory allocation, or to make any other modification desired. The MCNP preprocessor is called PRPR. PRPR is short, is written in pure FORTRAN 77, and contains no system dependent features. It should compile easily on all systems.

All changes to MCNP, both for the initial compilation and any subsequent modifications, should be done with the preprocessor. The MCNP source file, MCNPF.ID, should not be altered; **LANL X-5 will not support any modifications once the MCNP source file is altered.** You no longer have MCNP but your own code, which we do not support. Only changes implemented by a patch file and PRPR will be supported.

PRPR requires the FORTRAN source file and usually a correction or modification file known as a patch file. These files must be named CODEF and PATCH, respectively. PRPR retains or deletes sections of code according to \*DEFINE, \*IF DEF, and \*ENDIF directives in the MCNP source file. The \*DEFINE directive must be the first line(s) of the patch file. If no other changes are specified in the patch file, then the \*DEFINE directive can be the first line in the CODEF file and the patch file can be omitted. In either case, \*DEFINE must start in column 1.

The \*DEFINE directive has the form \*DEFINE name1,name2,...The names are chosen from the list below.

Names for hardware

CHEAP            32-bit floats and 32--bit integers

Names for operating systems

UNIX            Unix operating system.  
 UNICOS        Cray Unix time-sharing system. Don't use with UNIX.  
 SUN            Sun Solaris. Requires UNIX.  
 HPUX          HP operating system. Requires UNIX.  
 DEC            DEC Alpha Unix and SGI IRIX operating systems. Requires UNIX.  
                 PC Windows with DVF compiler. Do not use UNIX.

## APPENDIX C INSTALLING MCNP

AIX	IBM RS/6000. Requires UNIX.
PCDOS	PC Windows with Lahey compiler. Do not use UNIX.
LINUX	Linux operating system. Replicates UNIX system.
VMS	Digital Equipment VMS operating system.

### Names for optional features

POINTER	Dynamic memory allocation.
MULTT	Shared memory multitasking.
MULTP	Distributed memory multiprocessing. Requires one of following directives.
PVM	With Parallel Virtual Machine software.
MPI	With Message Passing Interface software. Under development.
XS64	Use 64-bit cross sections on CHEAP computers.
LP64	Long pointers (64-bit) on workstations.

### Names for plotting features

PLOT	Geometry plotting.
MC PLOT	Plotting tally results. Requires PLOT.
GKSSIM	Simulation of GKS by subroutines provided in MCNP. Requires one of the following graphics libraries
XLIB	X-Window graphics.
LAHEY	Lahey PC graphics (Winteractor).
QWIN	Digital Visual Fortran PC graphics (QuickWin).

For example, the following PATCH file will extract the appropriate MCNP code for the Sun Solaris system:

```
*define sun,unix,cheap,pointer,plot,mcplot,gkssim,xlib,xs64
```

Section II on page C-9 discusses other PRPR commands that can be used within the PATCH file to modify MCNP (e.g., set the variably dimensioned storage, the cross-section data path, etc.).

## 2. Creating PRPR, MAKXS.F, and MCNP executables

On most systems a script (or batch) file can be written to perform the necessary steps in creating PRPR, MAKXS.F, and MCNP executables. This script file is called MAKEMCNP. For systems supported by the installation package, this file is created automatically. A description of the necessary steps follows and the order of these steps is important:

1. Copy PATCH to PATCHF
2. Copy PRPR.ID to PRPR.F
3. Compile and link PRPR.F
4. Remove files PRPR.F, NEWID, and COMPILE
5. Copy the \*define line from PATCHF to PATCH
6. Copy MAKXS.ID to CODEF

7. Run PRPR
8. Rename COMPILE to MAKXS.F
9. Compile and link MAKXS.F
10. Remove files MAKXS.F, CODEF, and NEWID
11. Copy MCNPC.ID to CODEF
12. Run PRPR
13. Rename COMPILE to MCNPC.C
14. Using a C compiler, compile (but don't link) MCNPC.C
15. Remove file CODEF
16. Rename NEWID to NEWDIC
17. Copy PATCHF to PATCH
18. Copy MCNPF.ID to CODEF
19. Run PRPR
20. FSPLIT COMPILE into SUBROUTINE.F
21. Remove files CODEF and PATCH
22. Rename NEWID to NEWIDF
23. Using a FORTRAN compiler, compile (but don't link) SUBROUTINE.F
24. Link the MCNP object files (SUBROUTINE.O and MCNPC.O) with the appropriate system libraries

The upper-case file names are for clarity. Use the case appropriate for your operating system. On some systems the FORTRAN file suffix is .FOR rather than .F, and the object file suffix .OBJ rather than .O. The following example is MAKEMCNP for the Sun Solaris system:

```
#!/bin/sh
# Script file to make MCNP 4C on the Sun Solaris.
# Files needed: prpr.id,makxs.id,patch?,mcnpc.id,mcnpf.id.
set -ex
rm -f compile newid patch newidc newidf
cp prpr.id prpr.f
f77 -o prpr prpr.f
cp makxs.id codef
grep *define patchc > patch
./prpr
mv compile makxs.f
f77 -o makxsf makxs.f
rm -f newid *.f *.o
cp mcnpc.id codef
cp patchc patch
./prpr
mv compile mcnpc.c
cc -dalign -c -I/usr/openwin/include mcnpc.c
```

## APPENDIX C MODIFYING MCNP

```
rm -f codef patch
mv newid newidc
cp mcnpf.id codef
cp patchf patch
./prpr
mv compile compile.f
fsplit compile.f > clog
rm -f compile.f codef patch clog
mv newid newidf
mkdir flib
mkdir olib
f77 -O3 -Nn6000 -Nq6000 -Ns6000 -Nx2000 -dalign -c *.f
f77 -o mcnp *.o -L/usr/openwin/lib -lX11
mv *.f *.c flib
mv *.o olib
```

Note the MCNP FORTRAN routines are split into separate files for compilation (your compiler may or may not support this). This script links MCNP with the X-Window graphics library (libX11.a in /usr/openwin/lib).

### ***II. MODIFYING MCNP***

After the initial compilation of MCNP you may want to make minor modifications to the code. You should avoid the temptation to text edit the MCNP source file or routines that have already been compiled. Instead you should modify the code with PRPR and a patch file, using the `*edit` command to modify only the affected subroutines if you don't want to recompile the entire code. LANL X-5 will not support any version of MCNP that has been modified in any other way.

#### ***A. Creating a PRPR Patch File***

The preprocessor PRPR provided with MCNP makes it possible to maintain codes with the convenience of update patches on workstations where vendor supplied products are unavailable. Unlike other update emulators PRPR uses no binary files and is written in portable standard Fortran 77. PRPR reads a standard Fortran 77 source code that must be named CODEF, spreads common (`*comdeck` and `*call` commands) and keeps or deletes conditional code (`*define`, `*if def`, `*endif` commands), and then writes a compile file that will be called COMPILE. If an optional PATCH file is present with more than `*define` directives, a new CODEF file called NEWID is written according to `*insert`, `*delete`, `*before`, `*ident`, `*addfile`, `*deck`, and `*define` directives in the PATCH file. The COMPILE file is written when `*define` directives are present in either the PATCH or CODEF files. The `*edit` command can be used to recompile single subroutines for minor modifications of MCNP.

PRPR is used to maintain both MCNP and MAKXSF. Patches, in the form of PATCH files, can be developed, maintained, and tested with interim codes obtained from the NEWID and COMPILE files. Temporary fixes, such as compiler bug errors, are particularly attractive to correct with PATCH files rather than embedding lines into the source file where they are hard to remove later. Various PATCH files can be combined to form a new version of the source code by letting a NEWID file become the new CODEF source file.

The principal advantage of PRPR is that it can be used wherever Fortran 77, Fortran 90 or Fortran 95 is supported. Other advantages of PRPR are that it is machine-portable, simple (only 175 lines of Fortran plus 75 lines of comments), and operates directly on source code, not on an earlier program library.

The disadvantages and restrictions are shown below.

1. Available commands are limited to those listed in Table C.4.
2. All commands in PATCH must be in the same order as the corresponding code in CODEF. For example, changes to deck IM must come before changes to deck HS in PATCH because IM comes before HS in CODEF.
3. There are very few error traps. If your PATCH or CODEF files are wrong, PRPR will fail without warning. The few error messages provided are printed at the end of the NEWID file.
4. The FORTRAN source file must be named CODEF and the patch file must be named PATCH.
5. Files named NEWID and COMPILE must not be present when PRPR is executed.
6. The number of lines in a COMDECK and other dimensions are fixed by parameter statements and must be increased if exceeded.
7. \*define directives must be the first line(s) of either the PATCH or CODEF file.
8. \*addfile should be immediately followed by \*deck on the next line;
9. Either an \*ident or an \*addfile/\*deck must precede \*insert, \*delete, \*before, \*edit commands.
10. Nothing can be added after the last line of CODEF.

PRPR recognizes the directives shown in Table C.4.

**TABLE C.4:**

<u>Long Directive</u>	<u>Short Directive</u>	<u>Function</u>
*/	*/	comment
*define,c	*df,c	set condition
*ident,a	*id,a	change patch identifier to a
*edit,a	*e,a	process only deck a
*addfile ,b	*af ,b	add subroutine after deck b
*deck,a	*dk,a	change deck identifier to a



## APPENDIX C MODIFYING MCNP

**TABLE C.4:**

*insert,a.n	*i,a.n	insert lines after a.n
*delete,a.m,a.n	*d,a.m,a.n	delete or replace lines a.m through a.n
*before,a.n	*b,a.n	insert lines before a.n
*comdeck,a	*cd,a	define common deck a
*call,a	*ca,a	insert comdeck a
*if def,c,n		keep following n lines if condition c met
*endif	*ei	end conditional if

All commas above are optional except on the \*addfile directive, where the blank before the comma also is required. After each command a comment can be entered as shown in Example 1.

### Rules of operation:

1. If the PATCH file does not exist, COMPILE is produced from CODEF.
2. If the PATCH file exists and contains more than \*define directives, both NEWID and COMPILE files will be generated.
3. If no \*define directives are present, only NEWID is produced from CODEF.

For systems that do not have virtual memory or dynamic memory allocation, it is necessary to set the size of variable common in MCNP using the variable MDAS. MCNP will issue a warning message when a problem is too large for the MDAS value. One of the ways MCNP finds its cross-section data is by searching the path HDPATH that is set in a data statement at compilation time. Many workstations have faulty FORTRAN compilers that do not adhere to the full ANSI standard FORTRAN. Changes in the code may be necessary in the situations mentioned. All changes should be made with a patch file when MCNP is preprocessed. A sample patch file for setting \*DEFINE, changing MDAS to 2,500,000 words, and setting the default datapath to /home/yourpath on a Sun Unix system is shown in Example 1.

### Example 1

```
*define sun,unix,cheap,plot,mcplot,gkssim,xlib,xs64
*ident sunfix
*/ _____ comdeck zc
*delete,zc4c.4 line 22
    parameter (hdpth0='/home/yourpath')
*delete,zc4c.5 line 31
    parameter (mdas=2500000)
```

One line of this example is a comment. Without comments and with short directives it looks like:

```
*define sun,unix,cheap,plot,mcplot,gkssim,xlib,xs64
*id sunfix
*d,zc4c.4
    parameter (hdpth0='/home/yourpath')
*d,zc4c.5
    parameter (mdas=2500000)
```

### ***B. Creating a New MCNP Executable***

After preparing a PRPR patch file, a new MCNP executable must be created. If your system is one of those supported by the installation package, see section 1 below; otherwise, see section 2.

#### **1. Using the INSTALL.FIX File**

The INSTALL.FIX file can be used to incorporate your patch into the MCNP source. Add the following to your INSTALL.FIX file:

```
0 1 10 2
.
. ***** Enter your patch here, followed by a blank line *****
.
```

Omit the \*define line from your patch (the installer adds this for you). A blank line indicates the end of your patch. The meaning of the first line of numbers is explained in the INSTALL.FIX file supplied with the MCNP distribution. Having modified the fix file, rerun the install script as explained in Section I.A.1 on page C-2 (see Table C.3).

If your patch makes changes to any of the MCNP common blocks (i.e., ZC, VV, CM, GS, MB, or BD decks), then the MAKEMCNP and RUNPROB scripts must be run manually as described in sections 2 following and III.

#### **2. Using the MAKEMCNP Script**

Assuming a MAKEMCNP script is available or has been developed (see Section I.C.2 on page C-6), this script can be executed using the PRPR patch file containing your modifications. While this method may not be the most efficient means of recreating an executable (i.e., all subroutines will be recompiled), it is the most straightforward. Once completed, the test problems should be executed to help ensure the accuracy of your modifications (see below).

**APPENDIX C**  
**MCNP VERIFICATION**

**III. MCNP VERIFICATION**

**A. On Supported Systems**

MCNP comes with 29 test problems (TESTINP.TAR) and the other files shown below.

<u>FILE</u>	<u>DESCRIPTION</u>
RUNPROB	Script file for MCNP verification. Named RUNPROB.BAT for PC Windows systems.
TESTINP.TAR	Compressed input files for MCNP verification. Named TESTINP.ZIP for PC Windows systems.
TESTMCTL.SYS	Compressed tally output files for MCNP verification. Named TESTMCTL.ZIP for PC Windows systems.
TESTOUTP.SYS	Compressed MCNP output files for MCNP verification. Named TESTOUTP.ZIP for PC Windows systems.
TESTDIR	Cross-section directory for MCNP verification.
TESTLIB1	Cross-section data for MCNP verification.

Substitute the appropriate system identifier from Table C.1 for the “SYS” suffix. The following commands will uncompress the input/output files and execute the test problem script:

<u>COMMANDS</u>	<u>COMMENT</u>
tar -xf testinp.tar	UNIX systems - SYS keyword given in the table C.1
tar -xf testmctl.SYS	
tar -xf testoutp.SYS	
chmod a+x runprob	
runprob	
PKUNZIP -O TESTINP.ZIP	Windows systems
PKUNZIP -O TESTMCTL.ZIP	
PKUNZIP -O TESTOUTP.ZIP	
RUNPROB	

For other systems, a request must be made for the ASCII format of these files and a RUNPROB script file must be developed. This script performs the following steps for each of the 29 test problems:

1. Execute MCNP for the 1st test problem
2. Compare the tally output file (inp01m) with the standard (mctl01)
3. Compare the output file (inp01o) with the standard (outp01)
4. Remove the RUNTPE file (inp01r)

The following is a partial listing of the UNIX RUNPROB file:

```
#!/bin/sh
# script for MCNP verification
set -x
./mcpn name=inp01
diff inp01m mctl01 $>$ difm01
diff inp01o outp01 $>$ difo01
rm -f inp01r
./mcpn name=inp02
diff inp02m mctl02 $>$ difm02
diff inp02o outp02 $>$ difo02
rm -f inp02r
.
.
```

Upon completion, there should be 29 inp??m and inp??o files (?? = 01, 02, etc.). If any of these files are missing, test?? failed. Differences between these runs and the standard show up in the DIF?? files. Exact tracking is required for MCNP verification. Significant differences, that is, other than round-off in the last digit, may prove to be serious (e.g., compiler bugs). In such cases, the cause of the difference should be fully understood.

The test problems are neither good nor typical examples of MCNP problems. Rather, they are bizarre test configurations designed to exercise as many features as possible. The test set is constantly changed as new capabilities are added to MCNP and as bugs are corrected. The INPnn files are the same for all systems, but the answers, MCTL??, differ slightly from system to system because of differences in arithmetic processors. The test set works on the basis of “particle tracking” in which the random walks must be identical. The test problem data library TESTLIB 1 is also only for testing purposes because it contains bad data used to test the code. The TESTLIB 1 data should not be used for real transport problems.

### ***B. On VMS System***

The following commands will uncompress the input/output files and execute the test problem script:

<u>COMMANDS</u>	<u>COMMENT</u>
BACKUP TESTINP.VMS/SAVE *	VMS systems
BACKUP TESTOUTP.VMS/SAVE *	
BACKUP TESTMCTL.VMS/SAVE *	
COPY RUNPROB.VMS RUNPROB.COM	
@RUNPROB	

## APPENDIX C CONVERTING CROSS-SECTION FILES WITH MAKXSF

### *IV. CONVERTING CROSS-SECTION FILES WITH MAKXSF*

The auxiliary code MAKXSF can be used to convert cross-section libraries from one format to another and to construct custom-designed cross-section libraries.

MCNP can read cross-section data from two types of files. Type 1 files are formatted and have sequential access. Type 2 files are unformatted and have direct access. The cross-section files distributed by RSICC are all Type 1 files because Type 1 files are portable. But reading large formatted files is slow and formatted files are more bulky than unformatted files. The portable auxiliary program MAKXSF has been provided for translating big, slow, portable, Type 1 files into compact, fast, unportable (but still in compliance with Fortran 77, 90, and 95), Type 2 files. You can also use MAKXSF to delete cross-section tables that you do not need and to reorganize the cross-section tables into custom-designed cross-section libraries.

MAKXSF must be preprocessed and compiled in a manner similar to that described for MCNP. Examples of compiling MAKXSF are given in Section I.C.2 on page C-6. The PATCH file consists only of the same \*DEFINE directive used for MCNP.

The input files to MAKXSF are one or more existing cross-section libraries, a directory file that describes the input cross-section libraries, and a file called SPECS that tells MAKXSF what it is supposed to do. The output files are one or more new cross-section libraries, a new directory file that describes the new cross-section libraries, and a file called TPRINT that contains any error messages generated during the run. The input and output cross-section libraries can be any combination of Type 1 and Type 2 files. The various types of cross-section libraries and the form and contents of the cross-section directory file are described in detail in Appendix F1. The directory file XSDIR in the MCNP code package contains complete descriptions of all of the cross-section files in that package. You might print XSDIR and keep the listing as a reference that will tell you what cross-section tables you actually have on hand. The sample SPECS file in the MCNP code package is provided not only as an example of the correct form for a SPECS file but also as one that will be immediately useful to many users. With SPECS and MAKXSF you can create a complete set of Type 2 files from the Type 1 files in the MCNP code package.

The SPECS file is a formatted sequential file with records not exceeding 80 characters in length. The data items in each record may start in any column and are delimited by blanks. The contents of the file are given in Table C.5.

**TABLE C.5:**

<u>Record</u>	<u>Contents</u>				
1	name of old dir file	name of new dir file			
2	name of old xs lib*	name of new xs lib	Type	Recl*	Epr*
3	access route* entered into new directory file (or blank line)				
4 +	nuclide list, if old xs lib is absent				

Blank record  
 where \* = optional  
 Recl = record length; default is 4096, 2048, or 512, depending on system  
 Epr = entries per record; default is 512

Records 2 through 4+ can be repeated any number of times with data for additional new cross-section libraries. The SPECS file ends with a blank record. If “name of old cross–section library” exists on record 2, all nuclides from that library will be converted.

**TABLE C.6:**

<u>Record</u>	<u>Contents</u>				
1	xmdir1	xmdir2			
2	el1	el2	2	4096	512
3	home/scratch/el2				
4	rmccsab2 2				
5	datalib/rmccsab2				
6	7015.55c				
7	1001.50c				
8	blank record				

In Table C.6, the SPECS file starts with Type 1 directory XSDIR1, electron library EL1, and neutron libraries RMCCSA1 and RMCCS1. All nuclides on the electron data file EL1 are to be converted to a Type 2 file called EL2. For electron files only, all data is double precision, so for 512 entries per record (Epr) the record length (Recl) will be 4096 on both Cray and Unix systems. Records 4–7 tell MAKXSF to search all libraries listed in XSDIR1 until it finds nuclides 7015.55c and 1001.50c (which happen to be on RMCCSA1 and RMCCS1, respectively) and construct a new Type 2 library RMCCSAB2 consisting only of these nuclides. The entries per record (Epr) and record length (Recl) will be defaulted. The new directory file XSDIR2 will tell MCNP to look for the the electron cross sections in /home/scratch/el2 and for the neutron cross sections in /datalib/rmccsab2.

If the Type of the new cross-section file is specified to be 1 in record 2, only the name of the new cross-section file and the 1 for the Type are read in that record. If the Type in record 2 is 2, the

## APPENDIX C

### CONVERTING CROSS-SECTION FILES WITH MAKXSF

record length and the number of entries per record can be specified in case the defaults in MAKXSF are wrong for your system. The record length is in 8-bit bytes on the CRAY, and in words on VMS. If the record length is in words, it must be set equal to the number of entries per record ( $Recl = Epr$ ). If the record length is in bytes,  $Recl = 4 * Epr$  for CHEAP systems with 32-bit numeric storage units (except for electrons) and  $Recl = 8 * Epr$  for electron data and systems with 64-bit numeric storage units. The best value to use for the number of entries per record depends on the characteristics of the secondary storage, usually disks, on your computer system. If the number of entries is too large, there will be a lot of wasted space in the file because of the partial record at the end of each cross-section table. If the number of entries is too small, reading may be slow because of the large number of accesses. For many systems the default value,  $Epr = 512$ , is a good value. If you intend to use the SPECS file from the MCNP code package, be sure that the values of the record length and number of entries per record are suitable for your system. The default is  $Epr = 512$  and  $Recl = 4096, 2048$  or  $512$  depending upon the kind of system as determined in the \*DEFINE command when MAKXSF is preprocessed by PRPR.

The access route on record 3 of the SPECS file is a concatenation of either a Los Alamos Common File System path or a Unix data path with the library name and becomes the fourth entry for each nuclide in the library in the XSDIR file.

It is not necessary to generate all the cross-section files that you will ever need in one MAKXSF run. You can combine and edit directory files at any time with a text editor or with another MAKXSF run. The only requirement is that you must give MCNP a directory file that points to all the cross-section tables that are needed by the current problem. If you plan to run a long series of MCNP problems that all use the same small set of cross-section tables, it might be convenient to generate with MAKXSF a small special-purpose cross-section file and directory file just for your project.

There is another good use for MAKXSF that has nothing to do with cross-section tables, which is to use it as a test code to see whether your computer system fully supports Fortran 77. You might compile MAKXSF and convert the Type 1 cross-section files to Type 2 before tackling MCNP. The small size of MAKXSF makes it more convenient than MCNP for this testing purpose.

## APPENDIX D

### MODIFYING MCNP

Users sometimes have to modify MCNP for particular applications. In the past, most user modifications were for special sources or special tallies. The need for tally modifications has been greatly reduced by the generalization of the standard tallies in MCNP Versions 2 and 2B. The generalization of the standard sources in Version 3A has done the same for source modifications. However, users continue to find new applications for MCNP and will find new reasons to modify it.

This appendix contains information that users will need when they write modifications to MCNP. Other sections of this manual are also applicable, especially Chapter 2 for theory, Appendix E for variables and arrays in common, and Appendix F for the details of the cross-section tables.

This appendix is written with the assumption that the reader has a listing of MCNP, such as the files MCNPF.ID and MCNPC.ID, open in front of him so he can look at the sections of code referred to in the text.

#### CONTENTS OF APPENDIX D

I.	Preprocessors	page D-1
II.	Programming Language	page D-1
III.	Symbolic Names	page D-2
IV.	System Dependence	page D-3
V.	Common Blocks	page D-4
VI.	Dynamically Allocated Storage	page D-5
VII.	The RUNTPE File	page D-6
VIII.	C Functions	page D-7

#### ***I. PREPROCESSORS***

Before MCNP is compiled, it must be preprocessed to distribute the comdecks and to delete inappropriate system-dependent sections of code. The MCNP preprocessor is PRPR, a FORTRAN77<sup>1</sup> program that comes with the MCNP installation package. See Appendix C for information on the \*DEFINE directive required for selecting the appropriate system-dependent code and on how to load MCNP on the various systems.

#### ***II. PROGRAMMING LANGUAGE***

MCNP is written mostly in standard FORTRAN77. Deviations from the standard are avoided because they make it more difficult to maintain portability. MCNP programming currently deviates from the standard in the following areas: system-dependent features, system peculiarities, timing



## APPENDIX D SYMBOLIC NAMES

routines, X-window graphics, and dynamically allocated storage. The last three are implemented using C routines found in the distribution file MCNPC.ID.

Every dynamically allocated storage array in MCNP has an offset that is added to the first subscript expression in every reference to the array. This causes the value of the subscript expression to exceed the corresponding upper dimension bound for the array, which violates a FORTRAN rule. So far this has not caused trouble because the systems that MCNP currently runs on do not enforce the rule dynamically. The rule can not be enforced at compile time because the offset is a variable.

Common block PBLCOM, containing both floating-point and integer quantities, is equivalenced to an integer array that is used in some DO-loops that copy it to similar arrays. This is illegal in FORTRAN but works because the equivalenced arrays and variables are actually stored in the same places in memory.

Some special features of MCNP cannot be provided within the FORTRAN language. The special features are implemented by calling subroutines in the local libraries in the various computing facilities where MCNP is used. Some of the subroutine calls or preparations for the calls require nonstandard language. For example, the statement that fetches the execute-line message in the DEC VMS system is `CALL LIB$GET_FOREIGN(HM,,)`. There are too many characters in the name of this subroutine, it contains some illegal characters, and two of the arguments are void.

While the FORTRAN standard is not specific as to the case of the source characters, MCNP source files are distributed primarily in lower case. The few exceptions to this are predicated by the following comment : “CCCC ... must be upper case.” Changing the case of the source files should be avoided. Input to MCNP (via input files or the terminal) is now case insensitive. Case conversion is provided in subroutine NXTSYM.

### *III. SYMBOLIC NAMES*

In MCNP, the name of every entity in COMMON and the name of every function subprogram is at least three characters long. The name of every local entity, including statement functions, is less than three characters long. Thus, the local or global status of a symbolic name can be determined at a glance.

The default implicit typing of FORTRAN is used for all integer and real entities in MCNP. When MCNP is compiled on any 32-bit computer, the statement `IMPLICIT DOUBLE PRECISION (A-H,O-Z)` is included in all program units. There are no complex entities in MCNP nor are there any double-precision entities other than when double precision is used instead of real on 32-bit machines. Logical entities are rare and are always local. The names of most, not all, character entities begin with the letter H.

#### IV. SYSTEM DEPENDENCE

The use of standard FORTRAN goes a long way by itself toward making MCNP run on many different computer systems. However, differences between the systems still have to be allowed for to some extent.

The most important difference between hardware systems is that some have 60-bit or 64-bit words, whereas others, such as IBM and SUN machines, have 32-bit words. MCNP assumes that no more than 32 bits are available for integer quantities. MCNP assumes that at least 48 bits of precision are available for floating-point quantities. This requires double precision on 32-bit machines.

Geometry tracking in MCNP uses floating-point quantities without any special allowance for the fact that they are only approximations to the mathematical real numbers that they represent. This turns out to be a safe practice if the floating-point numbers have 48 bits of precision but not with much less than 48. The accuracy of cross-section data is so low that they could be represented adequately by 32-bit floating-point values, and because most of the memory used by a typical MCNP problem is filled with cross-section tables, one can use 32-bit words for them. We recommend use of 64-bit data to avoid problems on some systems. MCNP issues a fatal error if 32-bit data are inadequate. When 32-bit words are used for cross sections, problems fail to track 64-bit-data problems.

The magnitude of a floating-point number cannot exceed about  $10^{38}$  in most 32-bit machines; therefore, intermediate values do not exceed that limit. There are probably still sections of MCNP that can fail by trying to generate numbers greater than  $10^{38}$ .

The vector capability of Cray computers is a major hardware peculiarity that might speed up MCNP if we could find a way to exploit it. The attempts made so far to vectorize MCNP have not been successful and, in fact, have made it run more slowly. Part of the trouble is that Monte Carlo itself resists vectorization, especially with continuous-energy cross-section tables. Part of the trouble is that MCNP is a general-purpose program with a great many options that are implemented in hordes of IF statements. The one place in MCNP where there is some system-dependent code to facilitate vectorization is in subroutine TALSHF. The list-scoring parameter FTLS is affected by this bit of vectorization and has a special value in the Cray case. Only in rare problems does any of this make any significant difference.

The FORTRAN standard allows I/O units to be preconnected, which means that MCNP must avoid using certain unit numbers. Fortunately the preconnected unit numbers in all systems that MCNP currently runs on are numbers less than 10 or greater than 99. To avoid them, MCNP uses unit numbers in the thirties, forties, and fifties. VMS uses SYSS\$INPUT and SYSS\$OUTPUT to represent the user's terminal.

The FORTRAN standard does not specify the units for the length of the records of a direct-access file. Some systems define the length in bytes, some in words. This inconsistency does not affect the

## APPENDIX D COMMON BLOCKS

portability of MCNP. Direct access is used only for Type 2 cross-section files. The record length is read from the cross-section directory file and is entered explicitly in the input file to the auxiliary program MAKXSF, which writes the Type 2 files and the cross-section directory file. The question of the units occurs at the same time that the user chooses the size of the records, all in the context of the local system.

Some features of MCNP cannot be provided within the FORTRAN language. They are implemented by calling subroutines in local system libraries. Not all system-dependent features are available in all systems. The geometry-plotting feature is a special case. Its availability depends more on the local availability of GKS or of one of the other plotting packages – CGS, X-window, Lahey Winteractor, or DVF Quickwin – than on the nature of the computer system.

We have encountered bugs in compilers. Some of the comments in MCNP have CA in columns 1 and 2. These comments identify places where unusual programming has been done to get around compiler bugs.

System-dependent sections of code are set off by the preprocessor directives

```
*IF DEF,name ... *ENDIF or *IF DEF,name,n
```

See Appendix C for the names that are used and for how to use the preprocessors. As much as possible, we have tried to gather the system-dependent code in MCNP into only a few places, away from heavily mathematical parts of the program. One technique, exemplified by subroutine SETIDT, is to write a subroutine to do just one or several closely related system-dependent tasks. A subroutine of this sort consists of several alternative sections of code, one for each of the different systems. When that technique is impractical, we have tried to concentrate system-dependent code into the main program and into the top subroutines of the main sections. However, some system-dependent code is to be found almost anywhere. Finally, coding practices forced on us by the limitations of certain systems, such as keeping all integer values within 32 bits, affect the entire program.

### V. COMMON BLOCKS

Most of the common storage is in comdeck CM that is used by all MCNP program units except some short mathematical or system-oriented subprograms. This common storage is divided into nine separate common blocks. Dynamically allocated storage is in common block /DAC/, separate from statically allocated storage. Fixed, variable, and ephemeral data are separated to simplify maintenance of subroutine TPEFIL that writes and reads the RUNTPE file. Fixed data are defined in setting up the problem, are written to RUNTPE only once, and are not changed during transport. Variable data are changed during transport and have to be written to RUNTPE for each restart dump. Ephemeral data, in common blocks /EPHCOM/ and /TSKCOM/, are needed only during problem setup or only during the current history and are not written to RUNTPE. The particle

description variables that have to be saved when a detector tally is made, when a DXTRAN particle is generated, and when a particle is banked are in common block /PBLCOM/ that is separate from the rest of the ephemeral data. Character data are in a common block /CHARCM/ separate from the numerical data in accordance with the rules of FORTRAN. Tables of hard-wired data are in a separate block called /TABLES/.

If any of the following common blocks is changed, the marker variables at the ends of the floating point and integer portions of the block must remain in those places. The length parameters associated with the block may need to be changed. The values of the length parameters are the numbers of numeric storage units in the floating point and integer portions of the common block.

common block	marker variables	length parameters
/FIXCOM/	ZFIXCM, MFIXCM	NFIXCM, LFIXCM
/VARCOM/	ZVZRCM, MVARCM	NVARCM, LVARCM
/EPHCOM/	ZEPHCM, MEPHCM	NEPHCM, LEPHCM
/PBLCOM/	ZPBLCM, MPBLCM	NPBLCM, LPBLCM
	ZPB9CM, MPB9CM	
/TSKCOM/	ZTSKCM, MTSKCM	NTSKCM, LTSKCM

The expressions for some of the length parameters include the parameter NDP2 that is the number of numeric storage units needed for a floating-point quantity. It has the value 1 on 60-bit and 64-bit machines and 2 on 32-bit machines. If any changes are made to /PBLCOM/ before the real variable ZPBLCM or between the integer variables NPA and MPBLCM, those changes must be echoed in the section of duplicate variables ending in "9" (XXX9, YYY9, etc.). The last two small common blocks, /GKSSIM/ and /MSGCOM/, are used in graphics routines and message passing routines, respectively.

## ***VI. DYNAMICALLY ALLOCATED STORAGE***

MCNP uses a limited form of dynamically allocated storage. The lengths and locations of all dynamically allocated arrays are defined during problem setup and are not changed during transport and output. All dynamically allocated storage, for both real (double-precision on 32-bit machines) and integer arrays, is in common block /DAC/. /DAC/ contains only one declared array, DAS. All of the dynamically allocated arrays are equivalenced to DAS. When any dynamically allocated array is referenced, an offset is included in the first subscript expression. The offset for each array is equal to the offset of the previous array plus the length of the previous array. Most of the arrays are included in three sets of arrays, one each for fixed, variable, and ephemeral data. The arrays used for statistics (SHSD, STT, NHSD), tallying (TAL), and for nuclear data tables (XSS, EXS) follow at the end. The space these arrays occupy is also used for some temporary arrays

## APPENDIX D THE RUNTPE FILE

during problem setup and geometry plotting. The lengths of most of the arrays are determined during the course of a preliminary reading of the INP file by subroutine PASS1. The offsets of those arrays are calculated in subroutine SETDAS. The INP file is then rewound and is read again by subroutine RDPROB. This time the data from INP are actually stored. The length of TAL is calculated in subroutine ITALLY. The length of XSS is calculated in subroutines under XACT.

The parameter NDP2 is used to make the appropriate adjustments to the offsets where an integer array follows a floating-point array or vice versa.

On systems that provide dynamic memory size adjustment, DAS is dimensioned relatively small, and /DAC/ is loaded as the last thing in memory. At several points during the problem setup, the memory size is adjusted to make /DAC/ big enough to hold the arrays whose lengths have been defined. This is done on most systems using the FORTRAN POINTER statement and the C routines MALLOC and REALLOC (see page D-7 and the MCNPC.ID file). On systems without dynamic memory size adjustment, mostly virtual-memory systems, the parameter MDAS, which is the length of DAS, has to be set before compilation to be large enough for the biggest problem planned to be run but not so large as to violate whatever technical or administrative constraints may exist at the site.

### ***VII. THE RUNTPE FILE***

The RUNTPE file contains all the information needed to restart a problem in the continue-run mode. It can be used either to run more histories or to postprocess and plot tallies (see Appendix B.)

The RUNTPE file is sequential and unformatted. It is written and read by subroutine TPEFIL in conjunction with subroutines RUNTPR and RUNTPW. The first part of RUNTPE is a sequence of records containing fixed data for the problem. The rest of RUNTPE is a sequence of restart dumps, each consisting of a sequence of records containing variable data. The first dump is written immediately after the records of fixed data are written, before any transport calculations are done. Subsequent dumps are written from time to time during the initial run and during any continue-runs. If a continue-run is done with execute message item C, its dumps are written after the dump from which it started. If a continue-run is done with execute message item CN, its dumps are written after the fixed-data records. In either case, the number of dumps on the RUNTPE file can be limited by the fourth entry on the PRDMP card, see page 3-113.

#### Records in the Fixed-Data Part of the RUNTPE File

##### Identification Record

KOD*8	name of the code
VER*5	version identification
LODDAT*8	load date of the code
IDTM*19	machine designator, date and time

CHCD*10	charge code
PROBID*19	problem identification
PROBS*19	problem identification of surface source
AID*80	problem title
UFIL(3,6)*11	characteristics of user files
MXE	number of cross-section tables in the problem

Cross-section tables, MXE of them, one per record.

The contents of /FIXCOM/.

The part of /DAC/ that contains fixed data.

#### Records in a Restart Dump

Dump Identification Record

Current values of KOD, VER, LODDAT, IDTM, CHCD, and PROBID.

PROBID is always the same as in the initial identification record.

The contents of /VARCOM/.

The part of /DAC/ that contains variable data.

The part of /DAC/ that contains tally information, if any.

Endfile record, which is overwritten by the next dump.

### ***VIII. C FUNCTIONS***

The MCNP source includes a file (MCNPC.ID) of C functions that are implemented on most UNIX and PC systems. These functions can be grouped into three features: UNIX system timing, X-window graphics, and dynamic memory allocation. Use of these features requires an ANSI C compiler. At the top of the MCNPC.ID file are the standard include files followed by the bitmap description of the MCNP graphics X-window icon and the related XLIB variable structures and global variable definitions. The function ETIME provides a standard UNIX timing routine. The functions MALLOC and REALLF provide dynamic memory allocation. The remaining routines comprise MCNP/X-window interface functions. The terseness of these C routines is not typical of code written by C experts; however, it is consistent with the MCNP FORTRAN programming style. Note also the use of 6 characters or less in those C function names referenced from the FORTRAN. Other function names and variables reflect standard C programming.

### ***IX. REFERENCES***

1. American National Standards Institute, Inc., American National Standard Programming Language FORTRAN, ANSI X3.9-1978., (New York, 1978).

APPENDIX C  
INP File

## APPENDIX E

### GLOBAL CONSTANTS, VARIABLES, AND ARRAYS

This appendix contains information for users who need to modify MCNP. The first section is a dictionary of the symbolic names of the global entities in MCNP. The second section contains descriptions of some complicated arrays.

#### *I. DICTIONARY OF SYMBOLIC NAMES*

The global variables and arrays in MCNP are declared in COMMON statements that are in comdecks to reduce the bulk of the code and to simplify maintenance. The comdecks are copied into the MCNP program units in a preprocessor run before compilation. Some comdecks also contain PARAMETER statements that declare global named constants. Associated with each comdeck that has any common blocks is a BLOCK DATA subprogram that provides initial definitions for some of the entities in the common blocks. The arrangement of the common blocks and named constants in the comdecks and their related BLOCK DATA subprograms is as follows.

COMDECK LX Copyright notice

COMDECK ZC Double precision declaration and named constants

COMDECK VV Tables and character common

/TABLES/ Tables of constant data

/CHARCM/ Character variables and arrays

COMDECK CM with BLKDAT Common blocks for all program units

Includes comdeck ZC and VV

/FIXCOM/ Fixed common; unchanged after problem initiation.

/VARCOM/ Variable common; changes throughout random walk and is needed for continue run.

/EPHCOM/ Ephemeral common; not used in continue run.

/PBLCOM/ Particle description required for banking particles.

/TSKCOM/ Variable common repeated on each multitasking processor.

/ITSKPT/ Pointers to dynamically allocated variable and ephemeral common on each processor.

/DAC/ Dynamically allocated common; variably dimensioned arrays.

COMDECK GS Common block /GKSSIM/ for GKS simulation subroutines

COMDECK MB Common block /MSGCOM/ for multiprocessing message passing subroutines

COMDECK LKON Turn on multitasking lock



**APPENDIX E**  
**DICTIONARY OF SYMBOLIC NAMES**

COMDECK LKOFF Turn off multitasking lock

COMDECK JC with IBLDAT Common blocks for the IMCN program unit

Named constants

/IMCCOM/ Constants and ephemeral data  
 /JMCCOM/ Character variables and arrays

COMDECK PC with PBLDAT Common blocks for the PLOT geometry plotting section

Named constants

/PLTCOM/ Constants and ephemeral data  
 /QLTCOM/ Character variables and arrays

COMDECK LT with LANDCT Common block for XACT electron data

/LANCUT/ Ephemeral data

COMDECK LM with LANDAU Common block for MCRUN electron Landau treatment

/LANCOM/ Ephemeral data

COMDECK MP with ZBLDAT Common blocks for the MCPLLOT tally and cross section plotting section

/MPLCOM/ Constants and ephemeral data  
 /ZCHAR/ Character variables and arrays

The symbolic names of the global constants, variables, and arrays are listed alphabetically below. The dimension bounds (for arrays), the location, and a brief description is given for each entry. The adjustable dimension bound of each dynamically allocated array is indicated by a \*. The location of each variable or array is the name of its common block with the slashes omitted. The location of each global named constant is given as the comdeck designator followed by -par.

The names of the entities in /PBLCOM/ that end in 9 are not included in the dictionary. They are used only for saving temporarily the other entities in /PBLCOM/. The names of variables ending in TC are not included in the dictionary. They are the /TSKCOM/ equivalents of some variables in /VARCOM/.

AAAFD(2)	DAC	Array name for real fixed /DAC/
AAAVD(*)	DAC	Array name for real variable /DAC/
AB1(*)	DAC	X-coordinates of points to be plotted
AB2(*)	DAC	Y-coordinates of points to be plotted
ABHI(2)	MPLCOM	Upper x-axis limit of plot data
ABLO(2)	MPLCOM	Lower x-axis limit of plot data
AID*80	CHARCM	Title card of the initial run
AID1*80	CHARCM	Title card of the current run
AIDS*80	CHARCM	Title card of the surface source write run
AJSH	IMCCOM	Coefficient for surface area of a torus

**APPENDIX E**  
**DICTIONARY OF SYMBOLIC NAMES**

ALFA(3)	VARCOM	Collision estimate of alpha. See page E-48 1=collision estimate of alpha generation time; 2=1st order change in alfa(1) (<0); 3=2nd order change in alfa(1) (>0)
ALFAP(2)	PBLCOM	Alpha eigenvalue by 2nd order perturbation method
ALMIN	FIXCOM	Minimum allowed value of alpha
ALPHA(13)	VARCOM	Linear alpha moments. See page E-48
ALS	GKSSIM	Current distance along a polyline
AMFP	TSKCOM	Mean free paths to detector or DXTRAN sphere
AMX(4,4,*)	DAC	Matrices of surface coefficients from SCF
ANEUT	ZC-par	Neutron mass in a.m.u.
ANG(3)	TSKCOM	Surface normal and cosine of track direction
ARA(*)	DAC	Areas of the surfaces in the problem
ARAS(2,*)	DAC	Area calculated for each side of each surface
ASM(3,*)	DAC	Mesh indices of superimposed mesh
ASP(*)	DAC	Ionization loss straggling coefficients
ATSA(2,*)	DAC	Segment volume or area (for each side) of segment surface
AVGDN	ZC-par	1.e-24*Avogadro's number/neutron mass
AVLM(MLANC)	LANCUT	Average electron Landau scattering lambda cutoff
AVOGAD	ZC-par	Avogadro's number
AVRM(6)*1	CHARCM	x,y,z,r,z,t identifier of superimposed mesh
AWC(*)	DAC	Atomic weights for density conversions
AWN(*)	DAC	Atomic weights for neutron kinematics
AWT(*)	DAC	Atomic weights from AWTAB card
BASIS(9)	PLTCOM	Basis vectors for plotting
BBB(4,4)	IMCCOM	Transformation matrix in volume calculator
BBREM(MTOP)	FIXCOM	Bremstrahlung energy bias factors
BBV(*)	DAC	Equiprobable bins of a source function
BCW(2,3)	VARCOM	Coefficients of surface source biasing cylinder
BNUM	FIXCOM	Bremstrahlung bias number
CALPH(MAXI)	FIXCOM	Cosines of electron scattering group boundaries
CBWF	TSKCOM	Weight multiplier for source direction bias
CHCD*10	CHARCM	Charge code
CHITE(5)	GKSSIM	Character height parameters
CHUP(2)	GKSSIM	Character up vector
CLEV(MCLEVS)	MPLCOM	Contour levels
CMG(*)	DAC	Energy-dependent importances
CMULT	TSKCOM	Collision multiplicity
CNM(NKCD)*5	JMCCOM	List of all legal input-card names
COE(6,2,*)	DAC	Parametric coefficients of plot curves
COINCD	FIXCOM	Distance of coincidence. See DBCN(9)
COLL(MIPT)	VARCOM	Number of collisions in problem
COLOUT(3,11)	TSKCOM	Energy, cosine, time (delayed neutrons) of particles from collisions
COM*8	CHARCM	Name of plot command input file
COMOUT*8	CHARCM	Name of plot command output file
CONTUR(3)	MPLCOM	Contour level limits and interval
CP0	EPHCOM	Computer time used to start of MCRUN
CP1	EPHCOM	Computer time used after beginning MCRUN
CP2(MCPU)	EPHCOM	Computer time used so far for each processor
CP3	EPHCOM	Computer time of multiprocessing subtasks

## APPENDIX E

### DICTIONARY OF SYMBOLIC NAMES

CPA	EPHCOM	Computer time used up to start of MCNP
CPK	VARCOM	Computer time for settling in a KCODE problem
CPV	TSKCOM	Current time for time interrupt in VMS
CRS(*)	DAC	Intersections of plot curves
CTHICK	MPLCOM	Thickness of plot line
CTM	EPHCOM	Computer time cutoff from CTME card
CTS	VARCOM	Computer time used for transport in current problem including previous runs, if any
DAS(MDAS/NDP2)	DAC	Dynamically allocated storage
DBCN(30)	VARCOM	Debug controls from DBCN card
DDET	TSKCOM	Distance from collision point to detector
DDG(2,MXDT)	FIXCOM	Controls for detector diagnostics
DDM(2,*)	DAC	Size and history of largest score of each tally
DDN(24,*)	DAC	Detector diagnostics
DDX(MIPT,2,MXDX)	FIXCOM	Controls for DXTRAN diagnostics
DEB	TSKCOM	Distance to energy-group boundary
DEC(3,*)	DAC	Detector contributions by cell
DEN(*)	DAC	Mass densities of the cells
DFDMP	ZC-par	Default dump interval
DFTINT	ZC-par	Default interval between time interrupts
DISSF(3)	MPLCOM	Scaling factors due to DISSPLA limitation
DLS	PBLCOM	Distance to next boundary
DMP	VARCOM	Dump control from PRDMP card
DNB	FIXCOM	Delayed neutron bias (4th PHYS:N entry)
DPTB(3,*)	DAC	PERT card density change. See page page E-49
DRC(18,*)	DAC	Data saved for coincident detectors
DRS(*)	DAC	Electron energy substep range
DTC	PBLCOM	Distance to time cutoff
DTI(MLGC)	TSKCOM	Positive distances to surfaces
DUMN1*8	CHARCM	Dummy name for user-specified file
DUMN2*8	CHARCM	Dummy name for user-specified file
DUMN(15)*8	CHARCM	Spare file names
DXC(3,*)	DAC	DXTRAN contributions by cell
DXCP(0:MXDX,MIPT,*)	DAC	DXTRAN cell probabilities
DXD(MIPT,24,MXDX)	DAC	DXTRAN diagnostics
DXL	PBLCOM	Distance to nearest DXTRAN sphere
DXW(MIPT,3)	FIXCOM	DXTRAN weight cutoffs
DXX(MIPT,5,MXDX)	FIXCOM	DXTRAN sphere parameters
EAA(*)	DAC	Average values of source distributions
EACC(4)	VARCOM	Weight and energy of electrons above EMAX
EAR(*)	DAC	Ionization loss straggling coefficients
EBA(MTOP,*)	DAC	Unbiased cumulative prob. for photon/elec bremsstrahlung energy loss fractions.
EBD(MTOP,*)	DAC	Bremsstrahlung energy distributions
EBL(*)	DAC	Energy group bounds for photon production
EBT(MTOP,*)	DAC	Thick-target bremsstrahlung distributions
ECF(MIPT+1)	FIXCOM	Particle energy cutoffs
ECH(MPNG,MWNG,*)	DAC	Bremsstrahlung angular distributions
EDG(*)	DAC	K-edge energies

**APPENDIX E**  
**DICTIONARY OF SYMBOLIC NAMES**

EEE(*)	DAC	Energy grid for electron cross-section tables
EEK(*)	DAC	K x-ray energies
EFAC	FIXCOM	Ratio of adjacent energies in array EEE
EG0	TSKCOM	Energy of the particle before last collision
EGG(MAXI,*)	DAC	Electron scattering angle distribution
ELC(MIPT)	PBLCOM	Energy cutoffs in the current cell
ELP(MIPT,*)	DAC	Cell-dependent energy cutoffs
EMCF(MIPT)	FIXCOM	Cutin energy for analog capture (n,p) and for detailed photon physics (p)
EMX(MIPT)	FIXCOM	Maximum energy in problem for particle type
ENUM	FIXCOM	Secondary electron production bias number
EQLM(MLAM)	LANCOM	Landau electron scattering equiprobable bins
ERB(*)	DAC	Error bars for plot points
ERG	PBLCOM	Particle energy
ERGACE	TSKCOM	Raw energy extracted from cross-section table
ESA(*)	DAC	Cut-in energies for thermal S(A,B) tables
ESPL(MIPT,10)	FIXCOM	Controls for energy splitting
EULER	ZC-par	Euler constant used in electron transport
EWVG(*)	DAC	Energy bins for weight-window generator
EXMS*80	CHARCM	Execute message
EXS(*)	DAC	Electron cross sections
EXSAV(2)	PLTCOM	Saved extents
EXTENT(2)	PLTCOM	Extents for plotting
FDD(2,*)	DAC	Inhibitors of source frequency duplication
FEBL(2,*)	DAC	Number, weight of photons produced in each energy group
FES(33)	IMCCOM	Fission energy spectrum for KCODE source
FIM(MIPT+1,*)	DAC	Particle cell importances
FIML(MIPT)	PBLCOM	Importance of the current cell
FISMG	PBLCOM	Multigroup importance
FLAM(MLANC)	LANCUT	Landau electron scatter cutoff
FLC(*)	DAC	Electron landau scattering energy cutoff
FLX(*)	DAC	Tally of multigroup cell fluxes
FME(*)	DAC	Atom fractions from M cards
FMG(*)	DAC	Table for biased adjoint sampling
FNW	FIXCOM	Normalization of generated weight windows
FOR(MIPT,*)	DAC	Controls for forced collisions
FPI	EPHCOM	Reciprocal of number of histories
FRC(*)	DAC	Fraction of source cut off by energy limits
FREQ	EPHCOM	Interval between MCRUN calls of MCPLLOT
FSCON	ZC-par	Inverse fine-structure constant
FSO(*)	DAC	Fission source for KCODE
FST(*)	DAC	Bremsstrahlung bias correction factors
FTT(*)	DAC	TTB bremsstrahlung bias correction factors
GBNK(*)	DAC	The floating-point part of the bank
GEPHCOM(NEPHCOM)	EPHCOM	Array name of floating-point part of /EPHCOM/
GFIXCM(NFIXCM)	FIXCOM	Array name of floating-point part of /FIXCOM/
GMG(*)	DAC	Other-way fluxes for biased adjoint sampling
GPB9CM(MPB,NPBLCM+1)	PBLCOM	Floating-point stack in /PBLCOM/
GPBLCM(NPBLCM+1)	PBLCOM	Array name of floating-point part of /PBLCOM/
GPT(MIPT)	TABLES	Masses of particles

## APPENDIX E

### DICTIONARY OF SYMBOLIC NAMES

GTSKCM(NTSKCM)	TSKCOM	Array name of floating-point part of /TSKCOM/
GVARCM(NVARCM)	VARCOM	Array name of floating-point part of /VARCOM/
GVL(*)	DAC	Group-center velocities
GWT(*)	DAC	Minimum gamma production weights
HBLN(MAXV,4)*3	CHARCM	Names of SDEF and SSR source variables
HBLW(MAXW)*3	CHARCM	Names of SSW source variables
HCOLOR(NCOLOR)*12	QLTCOM	Color keywords of geometry plot
HCS(2)*7	CHARCM	“cell” and “surface”
HDPATH*80	CHARCM	Block data UNIX path to XSDIR and/or libraries
HDPATH0	ZC-par	Default value of cross section DATAPATH
HDPATH*80	CHARCM	UNIX path set other ways
HFT(MKFT)*3	CHARCM	Names of FT-card special treatments
HFU(2)*11	CHARCM	Legal values of file attribute FORM
HIP*(MIPT+1)	CHARCM	Initials of particle names
HITM*67	JMCCOM	Current item from input card
HLBL(43)*40	ZCHAR	Cross section plot reaction labels
HLIN*80	JMCCOM	Initial storage for newly read input line
HMES*69	CHARCM	Expire (bad trouble) message
HMOPT(MOPTS)*5	JMCCOM	M card options (gas, estep, plib, etc.)
HMSH(NMKEY)*7	JMCCOM	MESH card keywords
HNP(MIPT)*8	CHARCM	Names of particles
HOVR*8	CHARCM	Name of the current code section
HPBL(24)*7	JMCCOM	PTRAC keyword filters (x, y, z, etc.)
HPTB(NPKEY)*7	JMCCOM	PERT card key words
HPTR(NPTR)*7	JMCCOM	PTRAC keywords (buffer, cell, event, etc.)
HSB(NSP)	FIXCOM	Statistical analysis history score grid
HSD(2)*10	CHARCM	Legal values of file attribute ACCESS
HSLL	ZC-PAR	History score lower bin bound
HSUB*6	CHARCM	Subroutine where expire (bad trouble) occurred
HUGE	ZC-par	A very large number
HXSPU(15)*40	ZCHAR	Cross section plot ordinate labels
IAFG(*)	DAC	Reentrant particle weight window generator flag
IAP	PBLCOM	Program number of the next cell
IAX	TSKCOM	Flag for presence of AXS vector
IBAD	FIXCOM	Flag for simple bremsstrahlung distribution
IBC	TSKCOM	Index of the tally cosine bin
IBE	TSKCOM	Index of the tally energy bin
IBIN*9	CHARCM	Tally-bin type symbols
IBL(8,2)	MPLCOM	Bin range for plotting each tally bin type
IBNK(*)	DAC	The integer part of the bank
IBS	TSKCOM	Index of the tally segment bin
IBT	TSKCOM	Index of the tally time bin
IBU	TSKCOM	Index of the tally user bin
IC0	TSKCOM	Index for sampling ENDF law 67 neutrons
ICA	IMCCOM	Index of the type of the current input card
ICH*5	JMCCOM	Name in columns 1-5 of the current input card
ICHAN	EPHCOM	Terminal channel for TTY interrupt on VMS
ICL	PBLCOM	Program number of the current cell
ICLP(5,0:MXLV)	TSKCOM	Multilevel source cell and lattice indices

**APPENDIX E**  
**DICTIONARY OF SYMBOLIC NAMES**

ICN	IMCCOM	Number in columns 1-5 of current input card
ICOL	GKSSIM	GKS graphics color
ICOLOR(MPLM)	PLTCOM	Shading index for materials in plot
ICRN(3,*)	DAC	Surfaces and label of each cell corner
ICS	EPHCOM	Flag for error on current input card
ICURS	PLTCOM	Cursor flag
ICURS1	PLTCOM	Flag for saving initial conditions for cursor
ICUT(2)	MPLCOM	Index of lower x-axis limit of plot data
ICW	FIXCOM	Reference cell for generated weight windows
ICX	IMCCOM	Flag for asterisk on current input card
ID0	TSKCOM	Data index for neutron scattering ENDF law 67
IDBUF	MSGCOM	Buffer for PVM message passing
IDEFV(MAXV)	FIXCOM	Flags for presence of variable names on SDEF
IDES	FIXCOM	Flag to inhibit electron production by photons
IDET	TSKCOM	Index of the current detector
IDMP	EPHCOM	Number of the dump to start a continue run from
IDNA(*)	DAC	Macrobody surface facet names. See page E-51
IDNE(*)	DAC	List of identical surfaces. See page E-51
IDNS(*)	DAC	Locator in IDNE for list of identical surfaces. See page E-51
IDNT(*)	DAC	Program surface number of master identical surfaces. See page E-51
IDRC(MXDT)	FIXCOM	Links between master and slave detectors
IDTM*19	CHARCM	Machine designator and current date and time
IDTMS*19	CHARCM	IDTM of the surface source write run
IDUM(50)	VARCOM	Data from IDUM input card
IDX	PBLCOM	Number of the current DXTRAN sphere
IET	TSKCOM	Index of the current $S(\alpha,\beta)$ table
IEX	PBLCOM	Index of the current cross section table
IEXP	PBLCOM	IEX from previous collision
IFFT	FIXCOM	Flag for FT-card treatments SCX or SCD
IFILE	EPHCOM	I/O unit of current plot input file
IFIP(MIPT+1)	IMCCOM	Flag for presence of IP card
IFL(*)	DAC	Nodes at cell leavings, for tally flagging
IFREE(2)	MPLCOM	Indices of current free variables
IGM	FIXCOM	Total number of energy groups
III	PBLCOM	First lattice index of particle location
IIIFD(*)	DAC	Array name for integer fixed /DAC/
IIIVD(*)	DAC	Array name for integer variable /DAC/
IINT(*)	DAC	Surfaces crossed at the intersections
IITM	IMCCOM	Integer form of current item from input card
IKZ	FIXCOM	Number of KCODE cycles to skip before tallying
ILBL(9)*8	CHARCM	Names of the 8 kinds of tally bins
ILN	EPHCOM	Count of lines of input data
ILN1	EPHCOM	Saved count of lines of input data
IMD	TSKCOM	Indicator of monodirectional plane source
IMESH(NMKEY)	FIXCOM	Counts number of entries on each MESH card keyword
IMG	FIXCOM	Flag for electron-photon multigroup problem
IMT	FIXCOM	Number of times the surface source will occur
INAME*8	CHARCM	Name from name option on execution line
INDT	FIXCOM	Count of entries on MT cards

## APPENDIX E

### DICTIONARY OF SYMBOLIC NAMES

INFORM	EPHCOM	Flag for output to plot user
INIF	VARCOM	Flag to advance starting random number
INK(MINK)	FIXCOM	Output controls from PRINT card
INP*8	CHARCM	Name of problem input file
INPD	EPHCOM	TFC rendezvous frequency (5th PRDMP entry)
IOID	IMCCOM	Flag for VOID card
IOVR	EPHCOM	Index of the current code section
IPAC2(*)	DAC	Flags used to distinguish between population and tracks entering cell
IPAN(*)	DAC	Pointers into PAN for all the cells
IPCT	MPLCOM	Flag for percent contours
IPER	TSKCOM	Current perturbation index
IPERT	FIXCOM	Perturbation flag
IPHOT	FIXCOM	PHYS:E flag for electrons to produce photons
IPL	IMCCOM	Pointer into RTP for current tally card
IPLT	FIXCOM	Indicator how weight windows are to be used
IPNT(2,MKTC,0:*)	DAC	Pointers into RTP. See page E-41
IPRPTS	MPLCOM	Flag for printing instead of plotting points
IPSC	TSKCOM	Type of PSC calculation to make
IPT	PBLCOM	Type of particle
IPTAL(8,6,*)	DAC	Guide to tally bins. See page E-36
IPTB(2+2*NPKEY,*)	DAC	Pointers to RPTB array. See page E-50
IPTR	EPHCOM	PTRAC option flag
IPTRA(NPTR)	EPHCOM	Pointer to PTR() for each PTRAC keyword
IPTY(MIPT)	FIXCOM	Particle types to be written to surface source
IQC	PLTCOM	Index of current curve of current surface
IRC	IMCCOM	First column of data field of input line
IRS	IMCCOM	Index of the current source distribution
IRT	TSKCOM	Counter for renormalizing direction cosines
IRUP	EPHCOM	Flag set by user with ctrl-c interrupt
ISB	FIXCOM	Control parameter for adjoint biasing
ISBM	MP-par	X-dimension of contour or 3D sub-block
ISEF(2,*)	DAC	Source position tries and rejections
ISIC(MAXF)	TSKCOM	Distribution used for each source variable
ISM(3)	FIXCOM	Number of fine mesh surfaces in x,y,z or r,z,t
ISS(MXSS*)	DAC	Surfaces where input surface source is to start
ISSW	FIXCOM	Flag to cause surface source file to be written
IST	VARCOM	Where in FSO to store next KCODE source neutron
ISTO	VARCOM	Saved IST value to rerun lost history
ISTERN	FIXCOM	Memory offset for ITS3.0 Sternhiemer, Berger, Seltzer electron density effect treatment option
ISTRG	FIXCOM	Flag to inhibit electron energy straggling
ISUB(NDEF)*8	CHARCM	Names of I/O files
ITAL	TSKCOM	Index of the current tally
ITASK	EPHCOM	Number of active tasks
ITDS(*)	DAC	Tally specifications. See page E-37
ITERM	EPHCOM	Type of computer terminal
ITFC	MPLCOM	Type of TFC or KCODE plot
ITFXS	EPHCOM	Flag to indicate need for total-fission tables
ITI(MLGC)	TSKCOM	Surface numbers associated with DTI values

**APPENDIX E**  
**DICTIONARY OF SYMBOLIC NAMES**

ITID(MCPU)	MSGCOM	PVM pid mapping to subtask (0:ltasks)
ITIK(2)	MPLCOM	Number of divisions in each axis
ITS30	FIXCOM	Flag for ITS3.0 electron treatment
ITITLE(7)	MPLCOM	Flags for existence of titles
ITOTNU	EPHCOM	Flag for total vs prompt nubar
ITTY	TABLES	I/O unit for terminal keyboard
IU1	ZC-par	I/O unit for a scratch file
IU2	ZC-par	I/O unit for another scratch file
IU3	ZC-par	I/O unit for another scratch file
IU4	ZC-par	I/O unit for another scratch file
IUB	ZC-par	I/O unit for bank backup file
IUC	ZC-par	I/O unit for output plot command file
IUD	ZC-par	I/O unit for directory of cross section tables
IUI	ZC-par	I/O unit for problem input file
IUK	ZC-par	I/O unit for input plot command file
IUNR	FIXCOM	Number of nuclides with probability tables (negative if temperature correlations)
IUO	ZC-par	I/O unit for problem output file
IUOU	EPHCOM	Indicator that OUTP has been opened
IUP	ZC-par	I/O unit for intermediate file of plots
IUPC	ZC-par	PTRAC scratch file
IUPW	ZC-par	PTRAC output file
IUPX	ZC-par	Unit number of file for writing plot print points
IUR	ZC-par	I/O unit for file of restart dumps
IUS	ZC-par	I/O unit for KCODE source file
IUSC	ZC-par	I/O unit for surface source scratch file
IUSR	ZC-par	I/O unit for surface source input file
IUSW	ZC-par	I/O unit for surface source output file
IUT	ZC-par	I/O unit for output MCTAL file
IUW	ZC-par	I/O unit for input WWINP file
IUW1	ZC-par	I/O unit for output WWONE file
IUWE	ZC-par	I/O unit for output WWOUT file
IUX	ZC-par	I/O unit for files of cross section tables
IUZ	ZC-par	I/O unit for tally input file
IVDD(MAXF)	FIXCOM	For each dependent source variable, the number of the source variable depended upon
IVDIS(MAXV)	FIXCOM	Distribution number for each source variable
IVORD(MAXF)	FIXCOM	Source variable numbers in sampling order
IW0	TSKCOM	Index for sampling ENDF law 67 neutrons
IWWG	FIXCOM	Weight window generator flag = -1 fatal error on WWG or MESH cards = 0 no weight window generation = 1 cell-based generator or mesh-based generator with mesh from MESH card = 2 mesh-based generator with mesh from WWINP file
IXAK	VARCOM	Where in FSO to get next KCODE source neutron
IXAK0	VARCOM	Saved IXAK value to rerun lost history
IXC(61,*)	DAC	Encoded cross-section directory entries
IXCOS	TSKCOM	Pointer to cosine table for PSC calculation



## APPENDIX E

### DICTIONARY OF SYMBOLIC NAMES

IXL(3,*)	DAC	Encoded ZAIDs
IXRE	TSKCOM	Index of the collision reaction
IZA(*)	DAC	ZAs from M cards
J3D	MPLCOM	Flag: if 2 free variables, plot is 3D not 2D
JAP	TSKCOM	Program number of the next surface
JASR(MXSS*)	DAC	Input surface source surfaces to be used
JASW(*)	DAC	Surfaces from surface source input file
JBD	TSKCOM	Indicator for scoring flagged (or direct) bin
JBNK	TSKCOM	Number of particles in the bank in memory
JCHAR	EPHCOM	Current character position in input line
JCOND	DAC	Flags for M card COND option
JEMI	DAC	Flags for M card GAS option
JEPHCM(LEPHCM)	EPHCOM	Array name for integer part of /EPHCOM/
JEV	TSKCOM	Count of event-log lines printed
JFCN	EPHCOM	Flag indicating CN is in the execute message
JFIXCM(LFIXCM)	FIXCOM	Array name for integer part of /FIXCOM/
JFL(*)	DAC	Nodes of surface crossings, for tally flagging
JFQ(8,0:*)	DAC	Order for printing tally results
JFT(*)	DAC	User bin indexes for special tally treatments
JGF	EPHCOM	Indicator that plot goes to graphics metafile
JGM(MIPT)	FIXCOM	Number of energy groups for each particle
JGP	PBLCOM	Neutron: particle energy group number Photon: flag for photon generated electron progeny Electron: flag for positron
JGXA(2)	EPHCOM	Flag for active workstations
JGXO(2)	EPHCOM	Flag for open workstations
JJJ	PBLCOM	Second lattice index of particle location
JLBL(2,8)	MPLCOM	Key to cross section plot labels
JLIM(2)	MPLCOM	Flag that user-supplied limits are in effect
JLOC	PLTCOM	Flag for LOCATE command
JLOCK	TSKCOM	Status variable for multithreading memory/io lock 0=not used (ntasks=1); -1=lock not held by current task; 1=lock held by current task; 2=lock doubly held by current task
JMD(*)	DAC	Material mixture number pointer
JMT(*)	DAC	S( $\alpha,\beta$ ) material number pointer
JOVR(NOVR)	EPHCOM	Flags for cross sections to be executed
JPB9CM(MPB,LPBLCM+1)	PB9COM	Stored values of JPBLCM
JPBLCM(LPBLCM+1)	PBLCOM	Array name for the common block. See page E-33
JPTAL(18,*)	DAC	Basic tally information. See page E-36
JPTB(*)	DAC	Flag if perturbation correction $R_{Ij}$ required
JRAD	VARCOM	Latch for warning of unusual radius sampling
JRWB(16,MIPT)	TABLES	PWB columns corresponding to values of NTER
JSBM	MP-par	Y-dimension of contour or 3D sub-block
JSCAL	PLTCOM	Indicator of type of scales wanted on plot
JSCN(*)	DAC	Source comments
JSD(4,33)	IMCCOM	Flags for distributions that need space in SSO
JSF(MJSF)	TABLES	Numerical names of built-in source functions
JSS(*)	DAC	Surfaces for surface source output file
JST(2,*)	DAC	Stack of points in the current piece of cell

**APPENDIX E**  
**DICTIONARY OF SYMBOLIC NAMES**

JSU	PBLCOM	Program number of the current surface
JTA(2)	GKSSIM	Flag for active workstations
JTASKS	EPHCOM	Number of PVM subtasks, >0 for load balancing
JTF(8,*)	DAC	Indices for fluctuation charts. See page E-35
JTFC	EPHCOM	Flag to indicate TFC update is due
JTLS	TSKCOM	Count of the scores in the current history
JTLX	FIXCOM	Latch for the TALLYX warning message
JTR(*)	DAC	Transformation numbers from surface cards
JTSKCM(LTSKCM)	TSKCOM	Array name of integer part of /TSKCOM/
JTTY	TABLES	I/O unit for terminal printer or CRT
JUI	IMCCOM	Unit number of the current input file
JUN(*)	DAC	Universe number of each cell
JUNF	FIXCOM	Flag for repeated structures
JVARCM(LVARCM)	VARCOM	Array name for integer part of /VARCOM/
JVC(*)	DAC	Vector numbers from the VECT card
JVP	EPHCOM	Flag for square viewport
JXS(32,*)	DAC	Blocks of pointers into cross section tables
KALINT	VARCOM	Internal alpha settle cycle control
KALMAX	VARCOM	Internal alpha settle cycles per $k_{eff}$ cycle
KALPHA	FIXCOM	Specifies $k_{eff}$ estimator to use in alpha search
KALREG	VARCOM	$k_{eff}$ cycle to start ln-ln regression (default = kalsav+2)
KALSAV	VARCOM	$k_{eff}$ cycle to start accrual of average alpha
KAW(*)	DAC	Values of Z*1000+A from the AWTAB card
KBIN(8,2)	MPLCOM	Bin range for plotting each tally bin type
KBNK	ITSKPT	Task offset for IBNK array
KBP	EPHCOM	Interrupt flag for multitasking mode
KC8	VARCOM	-1/0/1 KCODE cycle: settle/not KCODE/active
KCL(102,*)	DAC	Cell numbers of grid points in the plot window
KCOLOR(NCOLOR+7)	EPHCOM	Color indices for geometry plot
KCP(*)	DAC	Descriptions of multi-level source cells
KCSF	VARCOM	Flag for KCODE source overlap
KCT	VARCOM	Number of KCODE cycles to run
KCY	VARCOM	Current KCODE cycle
KCZ	VARCOM	The last KCODE cycle completed
KDB	TSKCOM	Flag for lost particle or long history
KDBNPS	EPHCOM	NPS of bad trouble history in multitasking
KDDM	ITSKPT	Task offset for DDM array
KDDN	ITSKPT	Task offset for DDN array
KDEC	ITSKPT	Task offset for DEC array
KDR(*)	DAC	ZAs from DRXS card
KDRC	ITSKPT	Task offset for DRC array
KDUP(*)	DAC	List of input cards for detecting duplicates
KDXC	ITSKPT	Task offset for DXC array
KDXD	ITSKPT	Task offset for DXD array
KDY	DAC	Pointer for dynamic arrays under FORTLIB
KEYP(NKEYP)*8	QLTCOM	Command keywords of PLOT
KEYS(NKEYS)*8	ZCHAR	Command keywords of MCPLLOT
KF8	FIXCOM	Indicator of presence of F8 tallies
KFDD	ITSKPT	Task offset for FDD array

## APPENDIX E

### DICTIONARY OF SYMBOLIC NAMES

KFEB	ITSKPT	Pointer to FEBL array
KFL	FIXCOM	Flag for cell or surface tally flagging
KFLX	ITSKPT	Task offset for FLX array
KFM(*)	DAC	Type of curve each surface makes in plot plane
KFME	ITSKPT	Task offset for FME array
KFSO	ITSKPT	Task offset for FSO array
KFQ	FIXCOM	Facet number of macrobody surface
KGBN	ITSKPT	Task offset for GBNK array
KIFG	ITSKPT	Task offset for IAFG array
KIFL	ITSKPT	Task offset for IFL array
KISE	ITSKPT	Task offset for ISEF array
KITM	IMCCOM	Type of current item from input card
KJFL	ITSKPT	Task offset for JFL array
KJFT	ITSKPT	Task offset for JFT array
KJPB	ITSKPT	Task offset for JPTB array
KKK	PBLCOM	Third lattice index of particle location
KKTC	ITSKPT	Task offset for KTC array
KLAJ	ITSKPT	Task offset for LAJ array
KLBL(43)	MPLCOM	Key to cross section plot reaction labels
KLCJ	ITSKPT	Task offset for LCAJ array
KLIN*80	CHARCM	Input line currently being processed
KLS	GKSSIM	Phase of interrupted-line pattern
KLSE	ITSKPT	Task offset for LSE array
KMAZ	ITSKPT	Task offset for maze array
KMM(*)	DAC	Encoded IDs from M cards
KMPLOT	EPHCOM	Indicator of < ctrl-e > IMCPLOT interrupt
KMT(3,*)	DAC	Encoded ZAIDs from MT cards
KNDP	ITSKPT	Task offset for NDPF array
KNDR	ITSKPT	Task offset for NDR array
KNHS	ITSKPT	Task offset for NHSD array
KNMC	ITSKPT	Task offset for NMCP array
KNOD	VARCOM	Dump number
KNODS	FIXCOM	Last dump in the surface source write run
KNRM	FIXCOM	Type of normalization of KCODE tallies
KOD*8	ZC-par	Name of the code (MCNP)
KODS*8	CHARCM	Name of the code that wrote surface source file
KOMOUT	EPHCOM	Indicator that COMOUT has been created
KONRUN	EPHCOM	Continue-run flag
KOPLLOT	MPLCOM	Flag for coplot
KPAC	ITSKPT	Task offset for PAC array
KPAN	ITSKPT	Task offset for PAN array
KPC2	ITSKPT	Task offset for IPAC2 array
KPCC	ITSKPT	Task offset for PCC array
KPIK	ITSKPT	Task offset for PIK array
KPROD	EPHCOM	Flag for production status
KPT(MIPT)	FIXCOM	Indicators of particle types in problem
KPTB	ITSKPT	Task offset for PTB array
KPWB	ITSKPT	Task offset for PWB array
KQSS	TSKCOM	Latch for incrementing NQSW

**APPENDIX E**  
**DICTIONARY OF SYMBOLIC NAMES**

KRFLG	EPHCOM	Flag to do event printing
KRHO	ITSKPT	Task offset for RHO array
KRQ(7,NKCD)	IMCCOM	Attributes of all types of input data cards
KRTC	ITSKPT	Task offset for RTC array
KRTM	EPHCOM	Flag for run-time monitor
KSC(*)	DAC	0=nonplanar, 2=PX, 3=PY, 4=PZ, N=P plane with orientation N. Parallel planes have same value.
KSD(21,*)	DAC	Source distribution information. See page E-32
KSDEF	VARCOM	Flag for KCODE SDEF source
KSF(39)*3	CHARCM	List of all legal surface-type symbols
KSHS	ITSKPT	Pointer to SHSD array
KSM	DAC	Macrobody surface flag = master surface of facet = -surface type of master surface
KSR	EPHCOM	Number of sacrobody surface flag: econds left before job time limit
KST(*)	DAC	Surface-type numbers of all the surfaces
KSTT	ITSKPT	Task offset for STT array
KSU(*)	DAC	White (-2), reflecting (-1) or periodic (> 0) surface boundary
KSUM	ITSKPT	Task offset for SUMP array
KSWW	ITSKPT	Task offset for the SWWFA array
KTAL	ITSKPT	Task offset for TAL array
KTASK	TSKCOM	Index of the current task
KTC(2,*)	DAC	Current indices of energy grids. See page E-33
KTFILE	FIXCOM	Tally file open: none, RUNTPE, or MCTAL
KTGP	ITSKPT	Task offset for TGP array
KTL(NTALMX,2)	IMCCOM	Amount of storage needed for segment divisors
KTLS	FIXCOM	Length of list scoring space
KTMP	ITSKPT	Task offset for TMP array
KTP(MIPT,*)	DAC	Particle types included in each tally
KTR(*)	DAC	Cell transformation numbers from TRCL card
KTSKPT(LTSKPT)	ITSKPT	Array name of pointers in /ITSKPT/
KUFIL(2,6)	FIXCOM	Unit numbers and record lengths of user files
KURV	MPLCOM	Type of plot: histogram, plinear, etc.
KWFA	ITSKPT	Task offset for the WWFA array
KWNS	ITSKPT	Task offset for WNS array
KXD(*)	DAC	Encoded dates of XSDIR entries
KXS(*)	DAC	Indices of the cross section tables on RUNTPE
KXSMAT	MPLCOM	Cross section plot first material number in MAT array
KXSPAR	MPLCOM	Cross section plot source particle type number
KXSPEN(*)	DAC	Cross section plot xss array energy pointer
KXSPIE(*)	DAC	Cross section plot iex material indices
KXSPKM	MPLCOM	Cross section plot pointer to zaid in a material
KXSPLT	MPLCOM	Cross section plot number of nuclides in mat
KXSPMA	MPLCOM	Cross section plot material number from input file
KXSPMT	MPLCOM	Cross section plot reaction number
KXSPNX(*)	DAC	Cross section plot xss array number of energies
KXSPTP	MPLCOM	Cross section plot data type
KXSPU(43)	MPLCOM	Cross section plot reaction label indices
KXSPXS(*)	DAC	Cross section plot xss array cross section pointer

## APPENDIX E

### DICTIONARY OF SYMBOLIC NAMES

LAB1	MPLCOM	Offset for AB1 array
LAB2	MPLCOM	Offset for AB2 array
LAF(3,3)	DAC	Fill data for lattice elements
LAJ(*)	DAC	Cells on the other sides of the surfaces in LJA
LALPHA(6)	FIXCOM	Alpha pointers to PAC, PAN and PWB summary arrays to avoid accumulation in inactive cycles
LAMX	PLTCOM	Offset for AMX array
LARA	FIXCOM	Offset for ARA array
LARS	IMCCOM	Offset for ARAS array
LASM	FIXCOM	Offset for ASM array
LASP	FIXCOM	Offset for ASP array
LAT(2,*)	DAC	Lattice type and VCL pointer for each cell
LATS	IMCCOM	Offset for ATSA array
LAWC	FIXCOM	Offset for AWC array
LAWN	FIXCOM	Offset for AWN array
LAWT	IMCCOM	Offset for AWT array
LAX	MPLCOM	Indicator of which axes are logarithmic
LBB(*)	DAC	Size of records in bank backup file
LBBV	IMCCOM	Offset for BBV array
LBNK	FIXCOM	Offset for IBNK array
LCA(*)	DAC	For each cell, a pointer into LJA and LCAJ
LCAJ(*)	DAC	For each surface in LJA, a pointer into the list of other-side cells in LAJ
LCHNK	EPHCOM	Buffer size for passing PVM data
LCL(*)	DAC	List of cells bounded by the current surface
LCMG	FIXCOM	Offset for CMG array
LCOE	PLTCOM	Offset for COE array
LCOLOR	PLTCOM	Resolution of coloring for geometry plots
LCRS	PLTCOM	Offset for CRS array
LDDM	FIXCOM	Offset for DDM array
LDDN	FIXCOM	Offset for DDN array
LDEC	FIXCOM	Offset for DEC array
LDEN	FIXCOM	Offset for DEN array
LDPT	FIXCOM	Offset for DPTB array
LDRC	FIXCOM	Offset for DRC array
LDRS	FIXCOM	Offset for DRS array
LDUP	IMCCOM	Offset for KDUP array
LDXC	FIXCOM	Offset for DXC array
LDXD	FIXCOM	Offset for DXD array
LDXP	FIXCOM	Offset for DXCP array
LEAA	FIXCOM	Offset for EAA array
LEAR	FIXCOM	Offset for EAR array
LEBA	FIXCOM	Offset for EBA array
LEBD	FIXCOM	Offset for EBD array
LEBL	FIXCOM	Offset for EBL array
LEBT	FIXCOM	Offset for EBT array
LECH	FIXCOM	Offset for ECH array
LEDG	FIXCOM	Offset for EDG array
LEEE	FIXCOM	Offset for EEE array
LEEK	FIXCOM	Offset for EEK array

**APPENDIX E**  
**DICTIONARY OF SYMBOLIC NAMES**

LEGALC(NKEYS)	MPLCOM	Indicators of legal coplot commands
LEGALM(NKEYS)	MPLCOM	Indicators of legal runtime monitor commands
LEGALX(NKEYS)	MPLCOM	Cross section plot tag for legal plot commands
LEGEND	MPLCOM	Indicator of type of legend specified
LEGG	FIXCOM	Offset for EGG array
LELP	FIXCOM	Offset for ELP array
LLEPHCM	CM-par	Size of integer part of /EPHCOM/
LERB	MPLCOM	Offset for ERB array
LESA	FIXCOM	Offset for ESA array
LEV	PBLCOM	Level of the current particle
LEVP	TSKCOM	Level of the next boundary
LEVPLT	PLTCOM	Geometry plot level command level
LEWG	FIXCOM	Offsets for EWWG array
LEXS	FIXCOM	Length of electron cross section tables
LFATL	EPHCOM	Flag to run in spite of fatal errors
LFCDG	FIXCOM	End of floating-point fixed /DAC/
LFCDJ	FIXCOM	End of integer fixed /DAC/
LFCL(*)	DAC	Cells where fission is treated like capture
LFDD	FIXCOM	Offset for FDD array
LFEB	FIXCOM	Offset for FEBL array
LFIM	FIXCOM	Offset for FIM array
LFIXCM	CM-par	Size of integer part of /FIXCOM/
LFLC	FIXCOM	Offset for FLC array
LFLI	EPHCOM	Current length of /DAC/
LFLX	FIXCOM	Offset for FLX array
LFME	FIXCOM	Offset for FME array
LFMG	FIXCOM	Offset for FMG array
LFOR	FIXCOM	Offset for FOR array
LFRC	FIXCOM	Offset for FRC array
LFSD	FIXCOM	Offset for FSD array
LFST	FIXCOM	Offset for FST array
LFT(MKFT,*)	DAC	Pointers to FT-card data
LFTT	FIXCOM	Offset for FTT array
LGBN	FIXCOM	Offset for GBNK array
LGC(MLGC+1)	TSKCOM	Logical expression for the current point with respect to a particular cell
LGMG	FIXCOM	Offset for GMG array
LGVL	FIXCOM	Offset for GVL array
LGWT	FIXCOM	Offset for GWT array
LICC	IMCCOM	Length of /DAC/ during execution of IMCN
LICR	IMCCOM	Offset for ICRN array
LIDA	FIXCOM	Offset for IDNA array
LIDE	FIXCOM	Offset for IDNE array
LIDS	FIXCOM	Offset for IDNS array
LIDT	FIXCOM	Offset for IDNT array
LIFG	FIXCOM	Offset for IAFG array
LIFL	FIXCOM	Offset for IFL array
LIIN	IMCCOM	Offset for IINT array
LIKEF	IMCCOM	Flag for "LIKE m BUT" on cell card
LIPA	FIXCOM	Offset for IPAN array

## APPENDIX E

### DICTIONARY OF SYMBOLIC NAMES

LIPB	FIXCOM	Offset for IPTB array
LIPN	IMCCOM	Offset for IPNT array
LIPT	FIXCOM	Offset for IPTAL array
LISE	FIXCOM	Offset for ISEF array
LISS	FIXCOM	Offset for ISS array
LIT	IMCCOM	Length of ITDS array
LITD	FIXCOM	Offset for ITDS array
LIXC	FIXCOM	Offset for IXC array
LIXL	FIXCOM	Offset for IXL array
LIZA	FIXCOM	Offset for IZA array
LJA(*)	DAC	Logical geometrical definitions of all cells
LJAR	FIXCOM	Offset for JASR array
LJAV(*)	DAC	Logical geometrical definition of current cell
LJAW	IMCCOM	Offset for JASW array
LJCO	FIXCOM	Offset for JCOND array
LJEM	FIXCOM	Offset for JEMI array
LJFL	FIXCOM	Offset for JFL array
LJFQ	FIXCOM	Offset for JFQ array
LJFT	FIXCOM	Offset for JFT array
LJMD	FIXCOM	Offset for JMD array
LJMT	FIXCOM	Offset for JMT array
LJPB	FIXCOM	Offset for JPTB array
LJPT	FIXCOM	Offset for JPTAL array
LJSC	FIXCOM	Offset for JSCN array
LJSS	FIXCOM	Offset for JSS array
LJST	PLTCOM	Offset for JST array
LJSV(*)	DAC	List of the surfaces of the current cell
LJTF	FIXCOM	Offset for JTF array
LJTR	IMCCOM	Offset for JTR array
LJUN	FIXCOM	Offset for JUN array
LJVC	FIXCOM	Offset for JVC array
LJXS	FIXCOM	Offset for JXS array
LKAW	IMCCOM	Offset for KAW array
LKCL	PLTCOM	Offset for KCL array
LKCP	FIXCOM	Offset for KCP array
LKDR	IMCCOM	Offset for KDR array
LKFM	PLTCOM	Offset for KFM array
LKMM	FIXCOM	Offset for KMM array
LKMT	IMCCOM	Offset for KMT array
LKSC	FIXCOM	Offset for KSC array
LKSD	FIXCOM	Offset for KSD array
LKSM	FIXCOM	Offset for KSM array
LKST	FIXCOM	Offset for KST array
LKSU	FIXCOM	Offset for KSU array
LKTC	FIXCOM	Offset for KTC array
LKTP	FIXCOM	Offset for KTP array
LKTR	IMCCOM	Offset for KTR array
LKXD	FIXCOM	Offset for KXD array
LKXS	FIXCOM	Offset for KXS array

**APPENDIX E**  
**DICTIONARY OF SYMBOLIC NAMES**

LLAF	FIXCOM	Offset for LAF array
LLAJ	FIXCOM	Offset for LAJ array
LLAT	FIXCOM	Offset for LAT array
LLAV	IMCCOM	Offset for LAV array
LLBB	FIXCOM	Offset for LBB array
LLCA	FIXCOM	Offset for LCA array
LLCJ	FIXCOM	Offset for LCAJ array
LLCL	PLTCOM	Offset for LCL array
LLCT	FIXCOM	Offset for LOCCT array
LLFC	FIXCOM	Offset for LFCL array
LLFT	FIXCOM	Offset for LFT array
LLGTSK	FIXCOM	Offset for floating-point task arrays
LLJA	FIXCOM	Offset for LJA array
LLJTSK	FIXCOM	Offset for integer task arrays
LLME	FIXCOM	Offset for LME array
LLMT	FIXCOM	Offset for LMT array
LLPH	FIXCOM	Offset for LOCPH array
LLSA	IMCCOM	Offset for LSAT array
LLSC	FIXCOM	Offset for LSC array
LLSE	FIXCOM	Offset for LSE array
LLSG	PLTCOM	Offset for LSG array
LLST	FIXCOM	Offset for LOCST array
LLSV	IMCCOM	Offset for LJSV array
LLXD	IMCCOM	Offset for LXD array
LMAT	FIXCOM	Offset for MAT array
LMAZ	FIXCOM	Offset for MAZE array
LMB	FIXCOM	Location of temporary electron arrays
LMBD	FIXCOM	Offset for MBD array
LMBI	FIXCOM	Offset for MBI array
LMCC	MPLCOM	Offset for MCC array
LME(MIPT,*)	DAC	For each material, a list of the indices of the cross section tables
LMFL	FIXCOM	Offset for MFL array
LMFM	IMCCOM	Offset for MFM array
LMT(*)	DAC	For each material, a list of the indices of the applicable $S(\alpha,\beta)$ tables
LMZP	FIXCOM	Offset for MAZP array
LMZU	FIXCOM	Offset for MAZU array
LNCL	FIXCOM	Offset for NCL array
LNCS	PLTCOM	Offset for NCS array
LNDP	FIXCOM	Offset for NDPF array
LNDR	FIXCOM	Offset for NDR array
LNGM	FIXCOM	Offset for NGMFL array
LNHS	FIXCOM	Offset for NHSD array
LNHT	FIXCOM	Offset for NHTFL array
LNLV	IMCCOM	Offset for NLV array
LNMC	FIXCOM	Offset for NMCP array
LNMT	FIXCOM	Offset for NMT array
LN PQ	FIXCOM	Offset for NPQ array
LNPT	FIXCOM	Offset for NPTB array
LNPW	FIXCOM	Offset for NPSW array



## APPENDIX E

### DICTIONARY OF SYMBOLIC NAMES

LNSB	FIXCOM	Offset for NSB array
LNSF	FIXCOM	Offset for NSFM array
LNSL	FIXCOM	Offset for NSL array
LNSR	FIXCOM	Offset for NSLR array
LNSTYL	MPLCOM	Line type
LNTB	FIXCOM	Offset for NTBB array
LNTY	FIXCOM	Offset for NTY array
LNXS	FIXCOM	Offset for NXS Array
LOCCT(MIPT,*)	DAC	Cell-tally locators. See page E-38
LOC DT(2,MXDT)	FIXCOM	Detector-tally locators. See page E-37
LOCKI	EPHCOM	Integer lock variable
LOCKL	EPHCOM	Logical lock variable
LOCPH(*)	DAC	Pulse-height-tally locators
LOCST(MIPT,*)	DAC	Surface-tally locators. See page E-38
LODDAT*8	CHARCM	Date when the code was loaded
LODS*8	CHARCM	LODDAT of code that wrote surface source file
LORD	MPLCOM	Offset for ORD array
LOST(2)	VARCOM	Controls for handling lost particles
LPAC	FIXCOM	Offset for PAC array
LPAN	FIXCOM	Offset for PAN array
LPBLCM	CM-par	Length of /PBLCOM/
LPBR	FIXCOM	Offset for PBR array
LPBT	FIXCOM	Offset for PBT array
LPC2	FIXCOM	Offset for IPAC2 array
LPCC	FIXCOM	Offset for PCC array
LPERT	MPLCOM	Perturbation number for MC PLOT
LPIK	FIXCOM	Offset for PIK array
LPKN	FIXCOM	Offset for PKN array
LPLB	PLTCOM	Offset for PLB array
LPMG	FIXCOM	Offsets for PMG array
LPNTCM(LTSKPT)	FIXCOM	Equivalence array of k and l offsets for nonmultitasking problems
LPRB	IMCCOM	Offset for PRB array
LPRU	FIXCOM	Offset for PRU array
LPTB	FIXCOM	Offset for PTB array
LPTR	FIXCOM	Offset for PTR array
LPTS	FIXCOM	Offset for PTS array
LPUT	MPLCOM	Flag for title below plot
LPWB	FIXCOM	Offset for PWB array
LPXR	FIXCOM	Offset for PXR array
LQAV	FIXCOM	Offset for QAV array
LQAX	FIXCOM	Offset for QAX array
LQCN	FIXCOM	Offset for QCN array
LQMX	PLTCOM	Offset for QMX array
LRHO	FIXCOM	Offset for RHO array
LRKP	FIXCOM	Offset for RKPL array
LRNG	FIXCOM	Offset for RNG array
LRPT	FIXCOM	Offset for RPTB array
LRSC	IMCCOM	Offset for RSCRN array
LRSN	IMCCOM	Offset for RSINT array

**APPENDIX E**  
**DICTIONARY OF SYMBOLIC NAMES**

LRT	IMCCOM	Length of RTP array
LRTC	FIXCOM	Offset for RTC array
L RTP	IMCCOM	Offset for RTP array
LSAT(*)	DAC	For each segmented tally, a pointer into ATSA
LSB	TSKCOM	Latch for the count of bank overflows
LSC(*)	DAC	For each surface, a pointer into SCF
LSCF	FIXCOM	Offset for SCF array
LSCQ	IMCCOM	Offset for SCFQ array
LSCR	FIXCOM	Offset for SCR array
LSE(*)	DAC	Cells where source particles have appeared
LSFB	IMCCOM	Offset for SFB array
LSG(*)	DAC	Kind of line to plot for each segment of curve
LSHS	FIXCOM	Offset for SHSD array
LSMG	FIXCOM	Offset for SMG array
LSPEED	EPHCOM	Baud rate of the plotting terminal display
LSPF	FIXCOM	Offset for SPF array
LSQQ	FIXCOM	Offset for SQQ array
LSSO	FIXCOM	Offset for SSO array
LSTT	FIXCOM	Offset for STT array
LSUM	FIXCOM	Offset for SUMP array
LSWW	FIXCOM	Offset for SWWFA array
LTAL	FIXCOM	Offset for TAL array
LTASKS	EPHCOM	Number of PVM tasks =   JTASKS
LTBT	FIXCOM	Offset for TBT array
LTD	IMCCOM	Length of TDS array
LTDS	FIXCOM	Offset for TDS array
LTFC	FIXCOM	Offset for TFC array
LTGP	FIXCOM	Offset for TGP array
LTMP	FIXCOM	Offset for TMP array
LTRF	FIXCOM	Offset for TRF array
LTSKCM	CM-par	Size of integer part of /TSKCOM/
LTSKPT	CM-par	Number of pointers in /ITSKPT/
LTTH	FIXCOM	Offset for TTH array
LTYPE	GKSSIM	Line type
LVARCM	CM-par	Size of integer part of /VARCOM/
LVARSW	CM-par	Number of swept variable common integers
LVCDG	FIXCOM	End of floating-point variable /DAC/
LVCDJ	FIXCOM	End of integer variable /DAC/
LVCL	FIXCOM	Offset for VCL array
LVD	GKSSIM	DISSPLA level
LVEC	FIXCOM	Offset for VEC array
LVLS	IMCCOM	Offset for VOLS array
LVOL	FIXCOM	Offset for VOL array
LWFA	FIXCOM	Offset for WWFA array
LWGA	FIXCOM	Offset for WGMA array
LWGM	FIXCOM	Offset for WGM array
LWNS	FIXCOM	Offset for WNS array
LWWE	FIXCOM	Offset for WWE array
LWWF	FIXCOM	Offset for WWF array

## APPENDIX E

### DICTIONARY OF SYMBOLIC NAMES

LWWK	FIXCOM	Offset for WWK array
LXCC	MPLCOM	Offset for XCC array
LXD(MIPT,*)	DAC	Encoded Z Aid extension from M cards
LXEN	MPLCOM	Offset for KXSPEN array
LXIE	MPLCOM	Offset for KXSPIE array
LXLK	FIXCOM	Offset for XLK array
LXNM	FIXCOM	Offset for XNM array
LXNX	MPLCOM	Offset for KXSPNX array
LXRR	MPLCOM	Offset for XRR array
LXS	FIXCOM	Length of XSS array
LXSS	FIXCOM	Offset for XSS array
LXXS	MPLCOM	Offset for KXSPXS array
LX85	MPLCOM	Offset for XSE85 array
LYCC	MPLCOM	Offset for YCC array
LYLA	FIXCOM	Offset for YLA array
LYLK	FIXCOM	Offset for YLK array
LYRR	MPLCOM	Offset for YRR array
LZST	PLTCOM	Offset for ZST array
M1C	IMCCOM	General purpose variable for PASS1 and RDPROB
M2C	IMCCOM	General purpose variable for PASS1 and RDPROB
M3C	IMCCOM	General purpose variable for PASS1 and RDPROB
M4C	IMCCOM	General purpose variable for PASS1 and RDPROB
M5C	IMCCOM	General purpose variable for PASS1 and RDPROB
M6C	IMCCOM	General purpose variable for PASS1 and RDPROB
M7C	IMCCOM	General purpose variable for PASS1 and RDPROB
M8C	IMCCOM	General purpose variable for PASS1 and RDPROB
M9C	IMCCOM	General purpose variable for PASS1 and RDPROB
M10C	IMCCOM	General purpose variable for PASS1 and RDPROB
MAI	FIXCOM	Index number of reference mesh in mesh-based weight window generator
MAT(*)	DAC	Material numbers of the cells
MAXF	ZC-par	Number of sampleable source variables
MAXI	ZC-par	Number of electron scattering angle groups
MAXV	ZC-par	Number of SDEF source variables
MAXW	ZC-par	Number of SSW source variables
MAZE(*)	DAC	Universe/lattice map values. See page E-48
MAZF(3)	EPHCOM	Total source, entering, collisions in maze
MAZP(3,*)	DAC	Universe/lattice map addresses. See page E-48
MAZU(*)	DAC	Universe/lattice map pointers. See page E-49
MBB	TSKCOM	Size of the part of bank currently in memory
MBD(*)	DAC	Flags for cells for which DBMIN is inappropriate
MBI(*)	DAC	Which materials have bremsstrahlung biasing
MBNG	ZC-par	Number of possible photon/electron ratio values
MBNK	FIXCOM	Size of the bank
MCAL	FIXCOM	Type of multigroup problem
MCC(*)	DAC	Scratch array for MCPLOT
MCLB	PC-par	Number of LABEL command keywords
MCLEVS	MP-par	Maximum number of contour levels allowed for
MCOH	ZC-par	Number of WCO coherent form factors

**APPENDIX E**  
**DICTIONARY OF SYMBOLIC NAMES**

MCOLOR	EPHCOM	Number of colors available for geometry plots
MCPU	ZC-par	Maximum number of tasks allowed for
MCT	FIXCOM	Flag to write MCTAL file at end of the run
MCTAL*8	CHARCM	Name of output MCTAL file
MDAS	ZC-par	Initial length of /DAC/
MDC	EPHCOM	Flag indicating a dump is due to be written
MEPHCM	EPHCOM	Marker variable at end of /EPHCOM/
MFISS(22)	TABLES	Fission ZAIDS for BLKDAT fission Q-values
MFIXCM	FIXCOM	Marker variable at end of /FIXCOM/
MFL(3,*)	DAC	Fill data for each cell
MFM(*)	DAC	FM-card material numbers
MGEGBT(MIPT)	FIXCOM	Index of a multigroup table for each particle
MGM(MIPT+1)	FIXCOM	Cumulative number of multigroup groups
MGWW(MIPT+1)	FIXCOM	Cumulative sum of NGWW
MINC	ZC-par	Number of VIC incoherent form factors
MINK	ZC-par	Length of INK array
MIPT	ZC-par	Number of kinds of particles the code can run
MIPTS	IMCCOM	Source particle type
MIX	FIXCOM	Number of entries in KMM and FME
MJSF	ZC-par	Length of JSF array
MJSS	FIXCOM	Space needed for surfaces and cells from SSW
MKC	TSKCOM	Index of the current material
MKCP	IMCCOM	Size of array KCP
MKFT	ZC-par	Number of kinds of FT card special treatments
MKPL	ZC-par	No. of entries in RKPL array for kcode tally plots
MKTC	ZC-par	Number of kinds of tally cards
MLAF	IMCCOM	Space required for LAF
MLAJ	FIXCOM	Length of LAJ array
MLAM	LM-par	Landau electron scattering eqm bins
MLANC	LT-par	Electron Landau lambda cutoff values
MLGC	ZC-par	Size of logical arrays for complicated cells
MLJA	FIXCOM	Length of LJA array
MLOLD	LM-par	MCNP4A electron scattering told array size
MMKDB	EPHCOM	Print history info flag for EXPIRE
MNK	EPHCOM	Flag to indicate maximum printing is wanted
MNNM	FIXCOM	Maximum number of nuclides on M card
MOPTS	IMCCOM	Number of M card options (gas, estep, etc.)
MPAN	TSKCOM	Index in PAN of collision material/nuclide
MPB	ZC-par	Depth of the /PBLCOM/
MPB9CM(MPB)	PBLCOM	Marker variable in /PBLCOM/
MPBLCM	PBLCOM	Marker variable at end of /PBLCOM/
MPC	EPHCOM	Flag indicating that printing is due to be done
MPLM	PC-par	Number of material color shadings in plot
MPNG	ZC-par	Number of angle groups in ECH
MRKP	FIXCOM	Number of KCODE cycles kept for plotting
MRL	FIXCOM	Number of source points in FSO
MRM	EPHCOM	Flag indicating that plotting is due to be done
MSCAL	MPLCOM	Indicator of type of scales wanted on plot
MSD	FIXCOM	Number of source distributions

## APPENDIX E

### DICTIONARY OF SYMBOLIC NAMES

MSEB	ZC-par	Maximum number of equiprobable source bins
MSPARE	ZC-par	Number of spare entries in / PBLCOM/
MSRK	FIXCOM	Maximum number of source points in FSO
MSSC	IMCCOM	Length of source comments array JSCN
MSTP	ZC-par	Coarsening factor for electron energy grids
MSUB(NDEF)*8	CHARCM	Default names of files
MTAL	MPLCOM	Index of the current tally
MTASKS	FIXCOM	Multi-threading parallel offset, usually MTASKS+1
MTOP	ZC-par	Number of bremsstrahlung energy groups + 1
MTP	PBLCOM	Reaction MT from previous collision
MTSKCM	TSKCOM	Marker after integer part of /TSKCOM/
MTSKPT	ITSKPT	Marker after /ITSKPT/
MUNIT	GKSSIM	Postscript file unit number
MVARCM	VARCOM	Marker variable at end of /VARCOM/
MWNG	ZC-par	Number of photon energy groups in ECH
MWW(MIPT+1)	FIXCOM	Cumulative sum of NWW
MXA	FIXCOM	Number of cells in the problem
MXAFS	FIXCOM	Number of cells plus pseudocells for FS cards
MXDT	ZC-par	Maximum number of detectors
MXDX	ZC-par	Maximum number of DXTRAN spheres
MXE	FIXCOM	Number of cross section tables in the problem
MXE1	FIXCOM	First estimate (usually too big) of MXE
MXF	FIXCOM	Total number of tally bins
MXFP	FIXCOM	Number of tally bins without perturbations
MXIT	IMCCOM	Longest input geometry definition for any cell
MXJ	FIXCOM	Number of surfaces in the problem
MXLV	ZC-par	Maximum number of levels allowed for
MXSS	ZC-par	Spare dimension of surface source arrays
MXT	FIXCOM	Number of cell-temperature time bins
MXTR	FIXCOM	Number of surface transformations
MXXS	FIXCOM	Length of SPF and WNS
MYNUM	EPHCOM	PVM index (=0 for master task)
NACI	VARCOM	Number of inactive alpha cycles
NAW	IMCCOM	Number of atomic weights from AWTAB card
NBAL(MCPU)	VARCOM	Number of histories processed by each task
NBHWM	VARCOM	Largest number of particles ever in the bank
NBMX	ZC-par	Number of particles IBNK has room for
NBNK	TSKCOM	Number of particles in the bank
NBOV	VARCOM	Count of bank overflows
NBT(MIPT)	VARCOM	Total numbers particles banked
NCEL	PLTCOM	Number of cells bounded by the current surface
NCH(MIPT)	TSKCOM	Counts of neutron and photon collisions or electron substeps
NCL(*)	DAC	Problem numbers of the cells
NCLEV	MPLCOM	Number of contour levels
NCOLOR	ZC-par	Basic colors for plotting
NCOMP	IMCCOM	Count of # characters on cell cards
NCP	PBLCOM	Count of collisions per track
NCPAR(MIPT,NKCD)	IMCCOM	Largest cell parameter n, -1 if none
NCPARF	IMCCOM	Number of cell parameter cards on cell cards

**APPENDIX E**  
**DICTIONARY OF SYMBOLIC NAMES**

NCRN	IMCCOM	Number of corners in the current cell
NCRS	PLTCOM	Length of LSG and CRS arrays
NCS(*)	DAC	Number of curves where surface meets plot plane
NCTEXT	GKSSIM	GKS graphics color index
NDE	EPHCOM	Value of execute-message item DBUG n
NDEF	ZC-par	Number of file names
NDET(MIPT)	FIXCOM	Numbers of neutron and photon detectors
NDMP	VARCOM	Maximum number of dumps on RUNTPE
NDND	FIXCOM	Number of detectors in the problem
NDP(NTALMX)	IMCCOM	Tally numbers appearing with PD on cell cards
NDP2	ZC-par	Number of numeric storage units needed to store a floating-point value
NDPF(6,*)	DAC	Accounts of detector scores that failed
NDR	DAC	List of discrete-reaction rejections
NDTT	FIXCOM	Total number of detectors in the problem
NDUP(3)	IMCCOM	Number of cards in each input data block
NDX(MIPT)	FIXCOM	Numbers of neutron and photon DXTRAN spheres
NEE	FIXCOM	Number of energies in EEE (0 if no electrons)
NEPHCM	CM-par	Size of floating-point part of /EPHCOM/
NERR	VARCOM	Count of lost particles
NESM	VARCOM	Number of tracks that escape the superimposed mesh in mesh-based weight window generation
NETB(2)	VARCOM	Counts of numbers of times energy > EMX
NFER	VARCOM	Count of fatal errors found by IMCN or XACT
NFIXCM	CM-par	Size of floating-point part of /FIXCOM/
NFREE	MPLCOM	Number of free variables in current plot
NGMFL(*)	DAC	Gamma production flag for material iex for xs plot
NGP	TSKCOM	Electron energy group
NGWW(MIPT)	FIXCOM	Number of weight-window-generator energy bins
NHB	FIXCOM	Number of history bin computed from DBCN(16)
NHSD(NSP12,*)	DAC	Number in history score distribution which counts nonzero scores for statistical analysis
NHTFL(*)	DAC	Heating number flag for material iex for xs plot
NII	IMCCOM	Number of interpolated values to make; -1 for J
NILR(MXSS)	FIXCOM	Number of cells on SSR card
NILW	FIXCOM	Number of cells on SSW card
NIPS	FIXCOM	Source particle type
NISS	FIXCOM	Number of histories in input surface source
NITM	IMCCOM	Length of current item from input card
NIWR	IMCCOM	Number of cells in RSSA file
NJSR(MXSS)	FIXCOM	Number of surfaces in JASR
NJSS	FIXCOM	Number of surfaces in JSS
NJSW	IMCCOM	Number of surfaces in JASW
NJSX(MXSS)	FIXCOM	Number of surfaces in ISS
NKCD	JC-par	Number of different types of input cards
NKEYP	PC-par	Number of PLOT commands
NKEYS	MP-par	Number of MCPLOT commands
NKRP	EPHCOM	Latch for warning in CALCPS
NKXS	FIXCOM	Count of cross section tables written on RUNTPE
NLAJ	TSKCOM	Number of other-side cells in LAJ

## APPENDIX E

### DICTIONARY OF SYMBOLIC NAMES

NLAT	FIXCOM	Number of lattice universes in the problem
NLB	PLTCOM	Number of surface labels on the plot
NLEV	FIXCOM	Number of levels in the problem
NLJA	FIXCOM	Number of entries in LJA
NLSE	TSKCOM	Number of cells in the LSE list
NLT	TSKCOM	Number of entries in DTI
NLTEXT	GKSSIM	GKS graphics color index
NLV(*)	DAC	Number of levels in each cell
NMAT	FIXCOM	Number of materials in the problem
NMAT1	IMCCOM	First estimate (usually too big) of NMAT
NMAZ	FIXCOM	Length of maze array. (0 in 1st pass)
NMC	TSKCOM	Counter for weight window generator tracking
NMCO	PBLCOM	Stores value of NMC as it is updated
NMCP(4,1)	DAC	Track record array for weight window generator
NMFM	IMCCOM	2*number of materials on FM cards
NMIP	FIXCOM	No. of particle types for lattice/universe maze
NMKEY	ZC-par	Number of MESH keywords
NMRKP	ZC-par	Maximum number of kcode cycles to plot (mrkp)
NMT(*)	DAC	Names of the materials
NMXF	FIXCOM	Number of tally blocks =3 or =5 if DBCN(15) set to give VOV in all bins
NMZU	FIXCOM	Length of MAZU array
NNAL	VARCOM	Number of times alpha reset to almin
NNPOS	FIXCOM	Index of first position variable to be sampled
NOCOH	FIXCOM	Flag to inhibit coherent photon scattering
NODE	PBLCOM	Number of nodes in track from source to here
NOERBR	MPLCOM	Flag for no error bars
NOMORE	EPHCOM	Flag for exhausted surface-source file
NONORM	MPLCOM	Flag for no normalization
NORD	FIXCOM	Number of source variables to be sampled
NOVOL	IMCCOM	Flag to inhibit volume calculation
NOVR	ZC-par	Number of main code sections
NP1	FIXCOM	Number of histories in surface source write run
NPA	PBLCOM	Number of tracks in the same bank location
NPAGES	GKSSIM	Number of postscript file pages
NPB	TSKCOM	Number of saved particles in GPB9CM
NPBLCM	CM-par	Size of floating-point part of /PBLCOM/
NPC(20)	VARCOM	NPS for tally fluctuation charts. See page E-40
NPD	VARCOM	NPS step in tally fluctuation chart
NPERT	FIXCOM	Number of perturbations
NPIKMT	FIXCOM	Number of PIKMT entries
NPKEY	ZC-par	Number of PERT keywords
NPLB	PLTCOM	Length of PLB array
NPN	FIXCOM	Length of adjustable dimension of PAN
NPNM	VARCOM	Count of times neutron-reaction MT not found
NPP	VARCOM	Number of histories to run, from NPS card
NPPM	VARCOM	Count of times photon-production MT not found
NPQ(*)	DAC	Number of components in each material
NPS	VARCOM	Count of source particles started
NPSOUT	EPHCOM	NPS when output was last done

**APPENDIX E**  
**DICTIONARY OF SYMBOLIC NAMES**

NPSR	VARCOM	History number last read from surface source
NPSW(*)	DAC	For each surface source surface, the last history in which a track crossed it
NPT(2)	MPLCOM	Number of points to plot in each direction
NPTB(*)	DAC	Pointers to DPTB and RPTB arrays. See page E-50
NPTR	ZC-par	Number of PTRAC keywords (HPTR)
NQP(MIPT+1)	IMCCOM	Flags for particle-type indicators on card
NQSS	VARCOM	Number of histories read from surface source
NQSW	VARCOM	Number of histories written to surface source
NQW	IMCCOM	Particle type of input card. See JPTAL array page E-36
NRC	EPHCOM	Count of restarts in the run
NRCD	FIXCOM	Number of values in a surface-source record
NRNH(3)	VARCOM	Information about number of random numbers used
NRRS	VARCOM	Number of tracks read from surface source
NRSS	FIXCOM	Number of tracks on input surface source file
NRSW	VARCOM	Number of tracks written to surface source
NSA	VARCOM	Source particles yet to be done in this cycle
NSA0	VARCOM	Saved NSA value to rerun lost history
NSB(*)	DAC	Substeps per step for each material
NSC	IMCCOM	Number of surface coefficients in SCF
NSFM(*)	DAC	Problem names of surfaces
NSJV	IMCCOM	Length of cell definition in LJAV
NSKK	VARCOM	Number of histories in first IKZ KCODE cycles
NSL(2+4*MIPT,*)	DAC	Summary information for surface source file
NSLR(2+4*MIPT,*)	DAC	Summary information from surface source file
NSOM	VARCOM	Number of tracks that start outside superimposed mesh in mesh-based weight window generation
NSP	ZC-par	Number of points in history score distribution grid
NSP12	ZC-par	NSP+12
NSPH	FIXCOM	Flag for spherical output surface source
NSPT	ZC-par	NSP+NTP+7
NSR	FIXCOM	Source type
NSRC	IMCCOM	Number of entries on SRC card
NSRCK	FIXCOM	Nominal size of the KCODE source
NSS	VARCOM	Count of source points stored for the next cycle
NSS0	VARCOM	Saved NSS value to rerun lost history
NSSI(10)	VARCOM	Numbers of rejected surface source tracks
NST	EPHCOM	Reasons why the run is terminating
NSTP	FIXCOM	Value of MSTP for current electron library
NSTRID	FIXCOM	Random number stride, 152917 or DBCN(13)
NSUB	MSGCOM	Total number of PVM tasks (1+ltasks; private to PVM routines)
NSV	IMCCOM	Number of surfaces in LJSV
NTAL	FIXCOM	Number of tallies in the problem
NTALMX	JC-par	Maximum number of tallies
NTASKS	EPHCOM	Number of threads for multitasking or for each PVM subtask
NTBB(5,*)	DAC	Counts of scores beyond the last bin
NTC	VARCOM	Control variable for time check
NTC1	VARCOM	Second control variable for time check
NTER	TSKCOM	Type of termination of the track



## APPENDIX E

### DICTIONARY OF SYMBOLIC NAMES

NTII	TSKCOM	Indicator of multiple time interrupts
NTL(0:NTALMX)	IMCCOM	Tally numbers from tally input cards
NTOP	FIXCOM	MTOP value for current electron library
NTP	ZC-par	Number of tail points in history score distribution statistical analysis table
NTSKCM	CM-par	Size of floating-point part of /TSKCOM/
NTSS	VARCOM	Number of surface source tracks accepted
NTX	TSKCOM	Number of calls of TALLYX in user bins loop
NTY(*)	DAC	Type of each cross section table
NTYN	TSKCOM	Type of reaction in current collision
NUMB	FIXCOM	Flag for biasing bremsstrahlung production in each step
NVARCM	CM-par	Size of floating-point part of /VARCOM/
NVARSW	CM-par	Number of swept variable common float words
NVEC	FIXCOM	Number of vectors on VECT card
NVS(MAXV)	TABLES	Number of values for each source variable
NWANG	FIXCOM	Weight window mesh file type and adjoint current flag
NWC	IMCCOM	Count of items on current input card
NWER	VARCOM	Count of warning messages printed
NWGEOA	FIXCOM	For weight window generation on: 1/2/3=a superimposed rectangular mesh/a superimposed cylindrical mesh/cells
NWGEOM	FIXCOM	For weight windows from the WWINP file for: 1/2/3=rectangular mesh/cylindrical mesh/cells
NWGM	FIXCOM	Weight window mesh coarse meshes + 9 0th index entries
NWGMA	FIXCOM	Number of coarse mesh cells in superimposed grid for mesh-based weight window generation
NWNG	FIXCOM	Current number of ratios for bremsstrahlung angular distributions
NWWM	FIXCOM	Number of weight window mesh fine mesh cells
NWWMA	FIXCOM	Number of fine mesh cells in superimposed grid for mesh-based weight window generation
NWSB	VARCOM	Count of source weights below cutoff
NWSE	VARCOM	Count of source energies below cutoff
NWSG(3)	VARCOM	Count of source weights above weight window
NWST	VARCOM	Count of source times greater than cutoff
NWW(MIPT)	FIXCOM	Number of weight-window energy bins
NWWS(2,99)	VARCOM	Like NWSG and NWSL but binned
NXNORM	GKSSIM	Postscript file plot normalization
NXNX	FIXCOM	Number of DXTRAN spheres in the problem
NXP	PLTCOM	Number of intersections in CRS
NXS(16,*)	DAC	Blocks of descriptors of cross section tables
NXSC	IMCCOM	Number of XSn cards
NYNORM	GKSSIM	Postscript file plot normalization
NZIY(8,MXDX,MIPT)	VARCOM	DXTRANs lost to zero importance
ONE	ZC-par	Floating-point constant 1. for arguments
ORD(*)	DAC	Ordinates of points to be plotted
ORIGIN(3)	PLTCOM	Origin for plotting
ORSAV(3)	PLTCOM	Saved origin
OSUM(3)	VARCOM	$k_{eff}$ cumulative. See page E-46
OSUM2(3,3)	VARCOM	$k_{eff}$ covariances, cumulativ. See page E-46
OUTP*8	CHARCM	Name of problem output file

**APPENDIX E**  
**DICTIONARY OF SYMBOLIC NAMES**

PAC(MIPT,10,*)	DAC	Activity in each cell. See page E-43
PAN(2,6,*)	DAC	Activity of each nuclide. See page E-44
PAX(6,20,MIPT)	VARCOM	Ledger of creation and loss. See page E-41
PBR(*)	DAC	Bremsstrahlung production cross sections
PBT(5,*)	DAC	Thick-target bremsstrahlung probabilities
PCC(3,*)	DAC	Neutron-induced photons, by cell. See page E-45
PFP	TSKCOM	Probability of electron scatter
PHT(2)	MPLCOM	View angles for 3D plot
PIE	ZC-par	$\pi$
PIK(*)	DAC	Entries from PIKMT card
PIM(10:100)	LANCUT	Landau electron mean ionization potentials
PIMPH(9,4)	LANCUT	Landau electron mean ionization potentials
PKN(*)	DAC	Knock-on production cross sections
PLANCK	ZC-par	Planck constant
PLB(*)	DAC	Locations and widths of surface labels
PLE	TSKCOM	Macroscopic cross section of current cell
PLIM(4)	MPLCOM	Limits of the plot
PLMX(4,4)	PLTCOM	Plot matrix
PLOTM*8	CHARCM	Name of the graphics metafile
PMF	TSKCOM	Distance to next collision
PMG(*)	DAC	Table for biased adjoint sampling
PPTME(4)	VARCOM	Wall clock times for multiprocessing
PRB(*)	DAC	Probabilities for equiprobable-bin iteration
PRN	VARCOM	Print control from PRDMP card
PROBID*19	CHARCM	Problem identification
PROBS*19	CHARCM	PROBID of the surface source write run
PRU(*)	DAC	Part of the knock-on angular distribution
PSC	TSKCOM	Probability density for scattering toward a detector or DXTRAN sphere
PSIZE(4)	GKSSIM	Postscript file scale factor
PTB(5,*)	DAC	Perturbation coefficients. See page E-50
PTBTC	TSKCOM	Total perturbed tally score. See page E-51
PTR(*)	DAC	PTRAC input parameters
PTRAC*8	CHARCM	Name of the PTRAC file
PTS(*)	DAC	PTRAC track descriptions
PWB(MIPT,20,*)	DAC	Weight-balance tables. See page E-43
PXR(*)	DAC	X-ray production cross sections
PXX(4,4)	PLTCOM	Plot matrix transformed for all levels
QAV(*)	DAC	Ionization loss straggling coefficients
QAX(MIPT,*)	DAC	Exponential transform parameters for each cell
QCN(*)	DAC	Ionization loss straggling coefficients
QFISS(23)	TABLES	Fission Q-values
QMX(3,3,2,*)	DAC	Curves where surfaces intersect the plot plane
QPL	TSKCOM	Adjusted macroscopic cross section
RANB	TSKCOM	Upper part of pseudorandom number
RANI	VARCOM	Upper part of RIJK
RANJ	VARCOM	Lower part of RIJK
RANS	TSKCOM	Lower part of pseudorandom number
RDUM(50)	VARCOM	Data from RDUM input card
RES	PC-par	Plot resolution

## APPENDIX E

### DICTIONARY OF SYMBOLIC NAMES

RFQ(15)*57	CHARCM	Partial formats for termination messages
RGB(100)	GKSSIM	Triplets for colors in postscript files
RHO(*)	DAC	Atom densities of the cells
RIJK	VARCOM	Starting random number for the current history
RIM	FIXCOM	Compression limit for weight windows
RITM	IMCCOM	Real form of current item from input card
RKA(MBNG)	FIXCOM	Photon/electron energy ratios for angular distributions
RKK	VARCOM	Collision estimate of $k_{eff}$
RKPL(MKPL,*)	DAC	KCODE quantities for plotting. See page E-46
RKT(MTOP)	FIXCOM	Bremstrahlung photon/electron energy ratios for current electron library
RKTC(MTOP)	TABLES	Bremstrahlung photon/electron energy ratios for current electron library
RLT(4,2)	VARCOM	Removal lifetimes, current cycle. See page E-46
RNB(5)	TSKCOM	Saved random numbers for ENDF law 67 neutrons
RNFB	FIXCOM	Upper (big) 24 bits of RNMULT*NSTRID
RNFS	FIXCOM	Lower (small) 24 bits of RNMULT*NSTRID
RNG(*)	DAC	Electron ranges
RNGB	FIXCOM	Upper (big) 24 bits of RNMULT
RNGS	FIXCOM	Lower (small) 24 bits of RNMULT
RNK	PBLCOM	RNR at point where new track was created
RNMULT	FIXCOM	Random number multiplier = $5^{19}$ or DBCN(14r)
RNOK	FIXCOM	Knock-on electron production bias
RNR	VARCOM	Count of pseudorandom numbers generated
RNRTC0	TSKCOM	Initial random number of a history
RPTB(*)	DAC	PERT card keyword entries. See page E-51
RR0	TSKCOM	Interpolation fraction for ENDF law 67 neutrons
RSCRN(2,*)	DAC	R and S coordinates of cell corners
RSINT(2,*)	DAC	R and S coordinates of surface intersections
RSSA*8	CHARCM	Name of surface source input file
RSSP	VARCOM	Radius of spherical surface source
RSUM(3)	VARCOM	Removal lifetimes, cumulative. See page E-47
RSUM2(3,3)	VARCOM	Removal lifetime covariances, cumulative. See page E-47
RTC(15,*)	DAC	Current interpolated cross sections. See page E-33
RTP(*)	DAC	Tally-card data. See page E-41
RUNTPE*8	CHARCM	Name of file of restart dumps
SCALF(2,3)	MPLCOM	Scale factors for plot data
SCF(*)	DAC	Surface coefficients for all surfaces
SCFQ(5,*)	DAC	Q-form of surface coefficients
SCH	PLTCOM	Scale factor for geometry plots
SCLABL(4)	PLTCOM	LABEL parameters
SCR(*)	DAC	Scratch storage for GMGWW
SFB(*)	DAC	Probabilities of the source input groups
SFF(3,MAXF)	TSKCOM	Current values of source variables
SHSD(NSPT,*)	DAC	Score in the history score distribution for statistical analysis.
SIGA	TSKCOM	Capture cross section
SLITE	ZC-par	Speed of light
SMG(*)	DAC	Table for biased adjoint sampling
SMUL(3)	VARCOM	Tally of neutron multiplication
SNIT	VARCOM	Surface source splitting or RR factor
SPARE(MSPARE)	PBLCOM	Spare banked array for user modifications

**APPENDIX E**  
**DICTIONARY OF SYMBOLIC NAMES**

SPF(4,2)	DAC	Source probability distributions. See page E-32
SQQ(12,*)	DAC	Coefficients of the built-in source functions
SRCTP*8	CHARCM	Name of KCODE source file
SRV(3,MAXV)	FIXCOM	Explicit or default values of source variables
SSB(11)	EPHCOM	Surface source input buffer
SSO(*)	DAC	Equiprobable bins for source distributions
SSR	TSKCOM	Neutron speed relative to target nucleus
STP	TSKCOM	Electron stopping power
STT(NTP,*)	DAC	Big and small tally scores for statistical analysis
SUMK(3)	VARCOM	Sums of KCODE fission weight. See page E-48
SUMP(*)	DAC	Perturbed track length $k_{eff}$ . See page E-48
SWTM	VARCOM	Minimum weight of source particles
SWTX	IMCCOM	Minimum source weight for obsolete sources
SWWFA	DAC	Weight window generator scoring weight array
TAL(*)	DAC	Tally scores accumulation. See page E-35
TALB(8,2)	TABLES	Bins for detector and DXTRAN diagnostics
TBT(*)	DAC	Temperatures of the cross section tables
TCO(MIPT)	FIXCOM	Particle time cutoffs
TDC	EPHCOM	Time of writing latest dump to RUNTPE
TDS(*)	DAC	Tally specifications. See page E-38
TENSN	MPLCOM	Tension of a rational spline
TFC(6,20,*)	DAC	Tally fluctuation charts. See page E-40
TGP(*)	DAC	PIKMT biased photon production probability; or temporary KCODE fission production
THGF(0:50)	FIXCOM	Table of the thermal cross section function
THIRD	ZC-par	Floating-point constant 1/3
TITLES(7)*40	ZCHAR	Titles, legends, and labels
TLC	EPHCOM	Time of writing latest problem summary to OUTP
TMAV(MIPT,3)	VARCOM	Tallies of time to termination
TME	PBLCOM	Time at the particle position
TMP(*)	DAC	Temperatures of the cells
TOLD(MLOLD)	LANCOM	MCNP4A electron scattering lambda data
TOTGP1	TSKCOM	Total biased gamma-production cross section
TOTM	TSKCOM	Total microscopic cross section
TOTMP	PBLCOM	Total cross section for previous track
TPD(7)	TSKCOM	Stored collision data for PSC calculation
TPP(64)	TSKCOM	General-purpose scratch storage
TRF(17,0:1)	DAC	Geometry transformations
TRM	EPHCOM	Time of latest update of MCPLOT display
TTH(*)	DAC	Time bins for cell temperatures
TTN	TSKCOM	Temperature of the current cell
TWAC	VARCOM	Total weight accepted from surface source file
TWSS	VARCOM	Total weight read from surface source file
UDT(10,0:MXLV)	TSKCOM	Particle location, direction at higher levels
UDT1(10*MXLV+10)	TSKCOM	Synonym for UDT, for fast copying
UDTR(10*MXLV+10)	TSKCOM	Saves UDT for electron generation
UDTS(10*MXLV+10)	TSKCOM	Saves UDT for detectors and DXTRAN
UDTT(10*MXLV+10)	TSKCOM	Another array for saving UDT in
UFIL(3,6)*11	CHARCM	Name, access, and form of each user file

## APPENDIX E

### DICTIONARY OF SYMBOLIC NAMES

UOLD(3)	TSKCOM	Old direction cosines of track prior to collision
UUU	PBLCOM	Particle direction cosine with X-axis
VCL(3,7,*)	DAC	Lattice vectors and search constants
VCO(MCOH)	TABLES	Form factors for photon scattering
VEC(3,*)	DAC	Vectors from the VECT carr
VEL	PBLCOM	Speed of the particle
VER*5	ZC-par	Code version identification
VERS*5	CHARCM	Version of code that wrote surface source file
VIC(MINC)	TABLES	Form factors for photon scattering
VOL(*)	DAC	Volumes of the cells in the problem
VOLS(2,*)	DAC	Calculated volumes of the cells
VTR(3)	TSKCOM	Velocity of the target nucleus
VVV	PBLCOM	Particle direction cosine with Y-axis
WC1(MIPT)	FIXCOM	First weight cutoff
WC2(MIPT)	FIXCOM	Second weight cutoff
WCO(MCOH)	TABLES	Form factors for photon scattering
WCS1(MIPT)	VARCOM	First weight cutoff modified by SWTM
WCS2(MIPT)	VARCOM	Second weight cutoff modified by SWTM
WGM(*)	DAC	Geometry data for superimposed weight window mesh. See page E-49
WGMA(*)	DAC	Geometry data for superimposed weight window generator mesh. See page E-49
WGT	PBLCOM	Particle weight
WGTS(2)	VARCOM	Range of actual source weights
WNS(2,*)	DAC	Actual frequencies of source sampling
WNVP(4)	EPHCOM	Window and viewport limits
WSF	GKSSIM	Linewidth scale factor
WSSA*8	CHARCM	Name of surface source output file
WSSI(10)	VARCOM	Weights of rejected surface source tracks
WTO	VARCOM	Weight of each KCODE source point
WTFASV	PBLCOM	Accumulated weight of adjoint particle
WWE(*)	DAC	Weight-window energy bins
WWF(*)	DAC	Lower weight bounds for weight window
WWFA(*)	DAC	Weight window generator entering weight array
WWG(8)	FIXCOM	Controls for the weight window generator
WWINP*8	CHARCM	Weight window mesh input file name
WWK(*)	DAC	Auger electron generation probability
WWM(26)	FIXCOM	Weight window mesh parameters. See page E-49
WWMA(26)	FIXCOM	Weight window generator mesh parameters. See page E-49
WWONE*8	CHARCM	Name of single-group weight window generator. output file
WWOUT*8	CHARCM	Name of standard weight window generator output file
WWP(MIPT,7)	FIXCOM	Weight-window controls
WWW	PBLCOM	Particle direction cosine with Z-axis
XCC(*)	DAC	Scratch array for MCPLOT
XHOM	EPHCOM	Horizontal coordinate of home position
XLF	GKSSIM	Postscript plotting left x-axis tick
XLG	MPLCOM	Horizontal coordinate of legend
XLK(*)	DAC	ln of $k_{eff}$ vs. cycle number
XNM(*)	DAC	X-ray production bias factors
XNUM	EPHCOM	X-ray bias number

**APPENDIX E**  
**DICTIONARY OF SYMBOLIC NAMES**

XRR(*)	DAC	Real scratch array
XRT	GKSSIM	Postscript plotting right x-axis tick
XSDIR*8	CHARCM	Name of directory of cross section tables
XSE85(10,*)	DAC	Electron data by cell: 10 columns of print table 85
XSPTTL*10	MPLCOM	Cross section plot title
XSS(*)	DAC	Cross section tables
XST	MPLCOM	Horizontal coordinate of subtitle
XUNRL	FIXCOM	Lowest energy of any unresolved resonance probability table
XUNRU	FIXCOM	Highest energy of any unresolved resonance probability table
XXX	PBLCOM	X-coordinate of the particle position
XYZMN(3)	MPLCOM	Lower ends of plot axes
XYZMX(3)	MPLCOM	Upper ends of plot axes
YBT	GKSSIM	Postscript plotting top y-axis tick
YCC(*)	DAC	Scratch array for MCPLOT
YCN	TSKCOM	Temperature-normalized neutron velocity
YHOM	EPHCOM	Vertical coordinate of home position
YLG	MPLCOM	Vertical coordinate of legend
YLA(*)	DAC	ln of alpha vs. cycle number
YRR(*)	DAC	Real scratch array
YST	MPLCOM	Vertical coordinate of subtitle
YTP	GKSSIM	Postscript plotting bottom y-axis tick
YVAL	MPLCOM	Current location in plot legend area
YYY	PBLCOM	Y-coordinate of the particle position
ZEPHCM	EPHCOM	Marker after floating-point part of /EPHCOM/
ZERO	ZC-par	Floating-point constant 0. for arguments
ZFIXCM	FIXCOM	Marker after floating-point part of /FIXCOM/
ZPB9CM(MPB)	PBLCOM	Marker after floating-point part of /PBLCOM/
ZPBLCM	PBLCOM	Marker after floating-point part of /PBLCOM/
ZST(*)	DAC	Data buffer for PIX file
ZTSKCM	TSKCOM	Marker after floating-point part of /TSKCOM/
ZVARCM	VARCOM	Marker after floating-point part of /VARCOM/
ZZZ	PBLCOM	Z-coordinate of the particle position

**APPENDIX E**  
**SOME IMPORTANT COMPLICATED ARRAYS**

**II. SOME IMPORTANT COMPLICATED ARRAYS**

**A. Source Arrays**

KSD(21,MSD) Array Information About Each Source Distribution

KSD(LKSD+J,K) contains information of type J about source probability distribution K, as listed below.

- J
- 1 problem name of the distribution
  - 2 index of built-in function, if any
  - 3 length of comment in JSCN
  - 4 number of value sets from SI or DS card
  - 5 flag for discrete distribution: L, S, F, Q, or T option
  - 6 flag for distribution of distributions: S or Q option
  - 7 flag for dependent distribution: DS rather than SI
  - 8 flag for DS Q
  - 9 flag for DS T
  - 10 flag for SP V
  - 11 flag for SI F
  - 12 index of the variable of the distribution
  - 13 offset into SPF
  - 14 offset into SSO
  - 15 offset into JSCN
  - 16 offset into WNS
  - 17 number of equiprobable bins in each group, if any
  - 18 flag for biased distribution: SB card present
  - 19 flag for interpolated distribution: A option
  - 20 number of values on SP and/or SB card
  - 21 number of values per bin, including tag from Q or T option

SPF(4,MXXS) Array Source Probability Distributions

Each source distribution that is not just an unbiased function has a section of SPF. For a histogram distribution, the four rows of SPF contain

- row
- 1 values of the variable (triples for POS, AXS, or VEC)
  - 2 cumulative probability of each bin, possibly biased
  - 3 weight factor to compensate for the bias
  - 4 not used

If the distribution is linearly interpolated, the four rows contain

- |            |   |
|------------|---|
| <u>row</u> |   |
| 1          | values of the variable (never triple)         |
| 2          | unbiased probability density                  |
| 3          | biased probability density, if any            |
| 4          | cumulative probability for sampling which bin |

The above definitions are for the final SPF table as used in MCRUN. In IMCN the cumulative probabilities start out as probability per bin and the distributions may not yet be normalized.

**B. Transport Arrays**

GPBLCM(NPBLCM+1) and JPBLCM(LPBLCM+1) Arrays Particle and Collision Descriptors

GPBLCM and JPBLCM are the floating point and integer variables describing the state of a particle at any given time. GPBLCM is equivalenced to XXX, YYY, ZZZ, UUU, VVV, WWW, ERG, WGT, TME, etc., that describe a particle's x, y, and z-coordinates, u, v, and w-direction cosines, energy, weight, and time. JPBLCM is equivalenced to NPA, ICL, JSU, IPT, IEX, etc., that describe a particle's multiplicity, cell number, surface number, particle type, collision material index, etc. Having all the attributes of a particle in an array form is convenient for storing them temporarily in the GPB9CM and JPB9CM arrays at the start of a history, when generating secondary particles such as neutrons or photons, when generating "pseudo particles" for detectors and DXTRAN, and for banking particles. Banking a particle consists of copying the GPBLCM and JPBLCM arrays to the next block of space in IBNK, and getting a particle from the bank is the reverse. (Banking also consists of coping the UDT1 array if there are repeated structures and the GENR array if there is a weight window generator.)

KTC(2,MXE) and RTC(10,MXE) Arrays Interpolated Cross Sections

When interpolated values of cross sections are calculated at the current particle energy, they are stored in KTC and RTC for possible use later in the calculation of the details of the collision. The values stored in KTC(I,J) and RTC(I,J) are as follows:

For neutron cross sections, class C, D, or Y

- |     |  |
|-----|--|
| EGO | = neutron energy in laboratory frame     |
| ERG | = neutron energy in target-at-rest frame |
| KTC |  |
| 1   | index in cross-section table for EGO     |
| 2   | index in cross-section table for ERG     |
| RTC |  |
| 1   | table interpolation factor for EGO       |
| 2   | table interpolation factor for ERG       |



**APPENDIX E**  
**SOME IMPORTANT COMPLICATED ARRAYS**

- 3 absorption (n,0n) cross section for EGO
- 4 total cross section for EGO at temperature of table
- 5 total cross section for EGO at cell temperature
- 6 EGO
- 7 cell temperature
- 8 fission cross section
- 9
- 10 number of neutrons emitted by fission
- 11 probability table elastic cross section (-1 if not in unresolved range)
- 12 probability table fission cross section
- 13 probability table neutron heating number
- 14 probability table (n, $\gamma$ ) radiative capture cross section
- 15 random number used to sample probability table cross sections

For neutron  $S(\alpha,\beta)$  cross sections, class T

KTC

- 1 index in inelastic cross-section table
- 2 index in elastic cross-section table

RTC

- 1 inelastic interpolation factor
- 2
- 3
- 4 elastic interpolation factor
- 5
- 6 neutron energy
- 7 inelastic cross section plus elastic cross section
- 8 inelastic cross section
- 9
- 10

For photon cross sections, class P

RTC

- 1 incoherent scattering cross section
- 2 incoherent plus coherent scattering cross section
- 3 incoherent plus coherent plus photoelectric cross section
- 4 total cross section
- 5 photon heating number
- 6 photon energy
- 7
- 8
- 9
- 10

For multigroup neutron cross sections, class M

RTC

- 3 absorption (n,0n) cross section for EGO
- 5 total cross section for EGO at cell temperature
- 8 fission cross section
- 10 number of neutrons emitted by fission

For multigroup photon cross sections, class G

RTC

- 4 total cross section

### **C. Tally Arrays**

The tallying facilities in MCNP are very flexible. The places in the code where tally scoring is done are very heavily used. The arrays required for flexible and efficient tallying are numerous and complicated. The main tally arrays, grouped by function, are listed below. Arrays in parentheses are not discussed separately but are mentioned in the discussion of the preceding array.

Accumulation of scores: TAL

Controls: JPTAL, IPTAL, LOCDT, ITDS (LOCCT, LOCST), TDS

Fluctuation charts: TFC (JTF, NPC)

Initiation: RTP (IPNT)

#### TAL(\*) Array Tally Scores Accumulation

TAL is in dynamically allocated storage with offset LTAL. LTAL is usually not explicit in the subscript of TAL because the values of the various pointers into TAL include LTAL. TAL is usually divided into three blocks, each of length MXF. If the 15th DBCN card entry is nonzero, then all tallies have the variance of the variance computed and TAL is divided into five blocks. Unless list scoring is in effect (see below), tally scores made during the course of a history are added into tally bins in the first block. At the end of each history the scores in the first block are added into corresponding places in the second block, their squares are added into the third block, and the first block is zeroed. The fourth and fifth blocks carry the cumulative cubes and fourth-powers of the tally to compute the variance of the variance when applicable. Whenever printed output is called for, the sums in the second block and the sums of squares in the third block are used to calculate and print the tally estimates and their estimated errors.

Each of the blocks in TAL is divided into sections of various lengths, one for each tally in the problem. Each section is an eight-dimensional array of tally bins. The storage sequence is as if the section of TAL were an eight-dimensional FORTRAN array. The order of the eight dimensions, corresponding to a right-to-left reading of the dimensions of a FORTRAN array, the kind of bins each dimension represents, and the input cards that define them are as follows.

## APPENDIX E

### SOME IMPORTANT COMPLICATED ARRAYS

1	cell, surface, or detector bins	F
2	all vs flagged or all vs direct	CF, SF or F
3	user bins	FU
4	segment bins	FS
5	multiplier bins	FM
6	cosine bins	C
7	energy bins	E
8	time bins	T

The number of bins in each dimension is determined by rules set forth in the descriptions of the input cards in Chapter 3.

An alternative way of entering scores into the first block is automatically used if the number of scores per history is sufficiently small compared to the size of the block. Only the first of the three (or five) blocks in TAL is affected. The procedure is as follows. Index JTLS is incremented by 2, the score is entered at  $TAL(LTAL+JTLS-1)$ , and the location where the score would otherwise have gone is entered at  $TAL(LTAL+JTLS)$ . At the end of the history, scores with the same location are consolidated, the scores and their squares are added into the second and third blocks, and JTLS is set to zero. This technique is called list scoring. The scoring described previously is called table scoring. The reason for using list scoring is speed. It is used in only a small minority of problems but can in some cases make a big difference in running time.

#### JPTAL(8,NTAL) Array Basic Tally Information

JPTAL(LJPT+J,K) contains integer information of type J about tally K. Each pointer in JPTAL includes the offset of the array pointed into.

<u>J</u>	
1	problem number of the tally
2	tally type: 1, 2, 4, 5, 6, 7, or 8
3	NQW particle type: 1=N, 2=P, 3=P,N, 4=E, 6=E,P, 7=E,P,N
4	0 if nothing, 1 if asterisk, 2 if plus, on F card
5	offset in the first block in TAL of the section for tally K
6	location of the tally comment in ITDS
7	location in TAL of the tally fluctuation chart bin
8	1 for a point detector, 2 for a ring detector, 0 if not a detector tally

#### IPTAL(8,6,NTAL) Array Guide to Tally Bins

IPTAL(LIPT+I,J,K) contains information of type J about the bins of type I of tally K. The eight bin types I are defined above under TAL. The information types J are listed below, subject to the exceptions noted. Each pointer in IPTAL includes the offset of the array pointed into.

- J
- 1 offset in TDS or ITDS of specifications for the bins. If there is just one unbounded bin, the value is zero.  
Exceptions  
I=2: for cell or surface tally, location in ITDS of flagging cells  
for detector tally, the number of direct bins (0 or 1)  
I=4: program number of pseudocell for segmenting surfaces
  - 2 offset in TDS of bin multipliers  
Exceptions  
I=1: no meaning  
I=2: cell or surface tally: location in ITDS of flagging surfaces detector tally: offset  
in TDS of cell contributions  
I=3: location in TDS of the dose function  
I=4: offset in TDS of the table of segment divisors
  - 3 number of bins, which is never less than one
  - 4 number of bins including a total bin whether there actually is a total bin or not  
Exceptions  
I=1 and I=2 have no meaning.
  - 5 coefficients for calculating the location of a bin, given the eight bin indices
  - 6 flag (0/1 = no/yes) cumulative tally bin

LOCDT(2,MXDT) Array Detector-Tally Locators

LOCDT(1,J) is the program number of the tally of which detector J is a part. LOCDT(2,J) is the offset in the first block of TAL of the seven-dimensional array where scores for detector J are made.

ITDS(LIT) Array Tally Specifications

ITDS contains blocks, in no particular order and accessed only through pointers, that contain some of the specifications of the tallies of the problem. ITDS is in dynamically allocated storage with offset LITD. LITD is usually not explicit in the subscript of ITDS because the values of the various pointers into ITDS include LITD.

Tally Comment

The value of JPTAL(LJPT+6,K) is the location in ITDS of the comment for tally K. The first element of the comment is the number of additional elements in the comment. Each line of 67 characters is contained in 23 elements of ITDS, packed 3 characters per element. The packing uses the ICHAR function and a shift factor of 256. The characters are unpacked and processed by the CHAR function before being printed.

## APPENDIX E SOME IMPORTANT COMPLICATED ARRAYS

### Flagging Cells and Surfaces

The values of IPTAL(LIPT+2,1,K) and the values of IPTAL(LIPT+2,2,K) are the locations in ITDS of lists of the program numbers of flagging cells and flagging surfaces, respectively, for tally K. The first item of each list is the number of cells or surfaces in the list.

### Cell and Surface Bins

The value of IPTAL(LIPT+1,1,K) is the offset in ITDS of the description of the cell or surface bins of cell or surface tally K. The structure of the description is

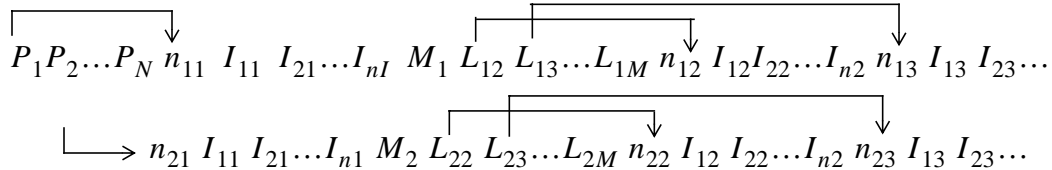

where

- $N$  = number of cell or surface bins in tally K
- $P_i$  = pointer to specifications for bin i
- $n_{ij}$  = number of cells or surfaces in level j of bin i
- $I_{ij}$  = program number of a cell or surface in level j. If negative, it is a lattice cell and the following three entries are element indices I,J,K).
- $M_i$  = number of levels in bin i minus one. If zero, no remaining data follows for this bin.
- $L_{ij}$  = pointer to specifications for level j of bin i

### Cell and Surface Tally Pointers

The value of LOCCT(I,J) if J is a cell—or LOCST(I,J) if J is a surface—is the location in ITDS of a table which locates the sections of TAL where tally scoring is done when a particle of type I passes through cell or surface J. The table is organized this way:

$$N \ T_1 \ m_1 \ L_{11} \ L_{21} \ \dots \ L_{m1} \ \dots \ T_N \ m_N \ L_{1N} \ L_{2N} \ \dots \ L_{mN}$$

where

- $N$  = number of tallies for particle type I which include cell or surface J
- $T_i$  = program number of a tally
- $m_i$  = number of bins that involve cell or surface J
- $L_{ji}$  = cell or surface bin number

### TDS(LTD) Array Tally Specifications

TDS contains blocks, in no particular order and accessed only through pointers, that contain some of the specifications of the tallies of the problem. TDS is in dynamically allocated storage with

offset LTDS\ null. LTDS is usually not explicit in the subscript of TDS because the values of the various pointers into TDS include LTDS.

**Detector Bins**

For detector tally K, the value of IPTAL(LIPT+1,1,K) is the offset in TDS of the description of the detector bins. The description contains the information from the F card, modified for faster use in TALLYD. Five elements of TDS are used for each detector:

	<u>Point detector</u>	<u>Ring detector</u>
1	X	a
2	Y	r
3	Z	1, 2, or 3 for x, y, or z
4	R	R
5	$ 2\pi R^3/3 $	$ 2\pi R^3/3 $

**Cell Contributions**

For detector tally K, the value of IPTAL(LIPT+2,2,K) is the offset in TDS of the table of cell contributions. The information in the table is exactly as it is on the PD card.

**Simple Bins and Multipliers**

The value of IPTAL(LIPT+I,1,K) for I = 3, 6, 7, or 8 is the offset in TDS of a table of bins for tally K. The information in the table is as it came from the corresponding input card except that any T or NT on the card does not appear in the table. The value of IPTAL(LIPT+I,2,K) for I = 6, 7, or 8 is the offset in TDS of a table of bin multipliers for tally K. The information in the table is exactly as it is on the input card.

**Segment Bin Divisors**

For cell or surface tally K, the value of IPTAL(LIPT+4,2,K) is the offset in TDS of the table of segment bin divisors. Except for a type 1 tally without any SD card, the table exists even if there is no FS card. The table is a two-dimensional array. One dimension is for cell or surface bins and the other is for the segment bins. The segment bin index changes faster. If segment bin divisors are not provided on an SD card, they are calculated or derived from VOL or AREA data, if possible, by MCNP according to the tally type:

tally type	2	4	6	7
divisor	area	volume	mass	mass

**Multiplier Bins**

The value of IPTAL(LIPT+5,2,K) is the offset in TDS of a table of the constant multipliers for the multiplier bins from the FM card of tally K\ null. If there is anything more on the FM card than just a constant multiplier for each bin, the value of IPTAL(LIPT+5,1,K) is the offset in TDS of a table of bin descriptions:

**APPENDIX E**  
**SOME IMPORTANT COMPLICATED ARRAYS**

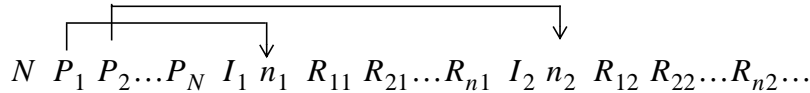

where

- $N$  = number of P's.
- $P_i$  = pointer to the description of a bin or attenuator. If the FM card has only a constant for some bin, then  $P_i = 0$  for that bin. If the FM card has C m but nothing more for a bin, (which makes it a track-count bin), then  $P_i = -1$ . If  $P_i$  points to an attenuator which appears inside parentheses on the FM card, it is negative.
- $I_i$  = for a regular bin, the program number of the material m specified on the FM card. For an attenuator,  $I_i = -1$ .
- $n_i$  = for a regular bin, the number of entries, including both reaction numbers and operators, in the bin description. If the list of reaction numbers in the bin includes the elastic or the total cross section,  $n_i$  is negative. For an attenuator,  $n_i$  is the number of entries, including material numbers and superficial-density values. If a regular bin appears on the FM card within parentheses that also contain an attenuator,  $n_i$  has 10000000 added to it for an attenuator to the right of the bin and 20000000 for an attenuator to the left.
- $R_{ji}$  = for a regular bin, a reaction number or operator. The sum operator, indicated by a colon on the FM card, is stored here as the value 100003. For an attenuator, the  $R_{ji}$  are alternating cell numbers and superficial-density values.

**Dose Function**

The value of IPTAL(LIPT+3,2,K) is the location in TDS of the dose function table for tally K. The first element in the table is the length N. It is followed by the N values of the energy and then the N values of the function. N is preceded by an indicator of the type of interpolation: 0 for log-log, 1 for lin-log, 2 for log-lin, and 3 for lin-lin.

**TFC(6,20,NTAL) Array Tally Fluctuation Charts**

The value of TFC(LTFC+I,J,K) is the tally value (I=1), the error (I=2), the figure of merit (I=3), the variance of the variance (I=4), the Pareto slope (I=5), and a locator for the Pareto tail plot (I=6) for line J of the tally fluctuation chart for tally K. The tally bin involved is designated by the eight indices in JTF(LJTF+I,K) for I = 1 to 8. The number of histories run at the point where the entries for a line were calculated is stored in NPC(J). Initially a line is calculated every 1000 histories. When the 20th line is generated, the history increment is doubled. When the time comes to generate the 21st line, the odd-numbered lines are eliminated, the data in line J are moved to line J/2 for J = 2 to 20 by 2, and the new data are put in line 11.

RTP(LRT) Array Information from Tally Input Cards

The information from most tally input cards is stored without much modification in temporary array RTP. Numbers are stored as is. Special characters are encoded. After all the input cards have been read, subroutine ITALLY sets up the permanent tally control arrays from the information in RTP. The main reason for this two-step process is that some of the control arrays depend in a complicated way on information from more than one input card. It is simpler to generate the control arrays with all the input data available at the same time than to do it as the cards are read.

Pointer array IPNT(2,21,0:NTAL) is defined as the tally cards are read. The information from tally card type J of tally K begins at RTP(LRTP+ \break IPNT(LIPN+1,J,K)) and occupies IPNT(LIPN+2,J,K) elements of RTP. The tally card type numbers J are given in KRQ(3,N) for each type N of input card. KRQ(3,N) is defined by DATA statements in block data subprogram IBLDAT\null. KRQ(3,N) is zero for nontally input cards. There is no tally card type 1. IPNT(LIPN+1,1,K) is used for bits that reflect T or NT on certain cards and indicate whether a total bin needs to be included. The value of IPNT(LIPN+1,2,K) is 1, 2, 3, 4, or 5, depending on whether the F card for the tally has blank, X, Y, Z, or W with the F, and it is negative if there is an asterisk on that card.

**D. Accounting Arrays**

MCNP regularly collects and prints data on the behavior of the particles transported through the problem geometry. This is accounting information which shows what MCNP actually did, in contrast to the tallies which are estimates of physically measurable quantities. The accounting information is essential to a user who is trying to make his problem run faster. The arrays where the accounting data are collected and the titles of the tables where they are printed are as follows.

PAX	Problem Summary
PAC	Problem Activity in Each Cell (Print Table 126)
PWB	Weight Balance in Each Cell (Print Table 130)
PAN	Activity of Each Nuclide in Each Cell (Print Table 140)
PCC	} Summary of Photons Produced in Neutron Collisions
FEBL	

PAX(6,20,MIPT) Array Problem Summary

The value of PAX(J,K,I) is the total of type I data for mechanism J and particle type K.

<u>I</u>	
1	number of tracks created
2	weight created



**APPENDIX E**  
**SOME IMPORTANT COMPLICATED ARRAYS**

- 3 energy created
- 4 number of tracks terminated
- 5 weight terminated
- 6 energy terminated

<u>J</u>	<u>Particle</u>	<u>Creation Mechanism</u>	<u>Loss Mechanism</u> }
1	NPE	source	escape
2	NPE		energy cutoff
3	NPE		time cutoff
4	NPE	weight window	weight window
5	NPE	cell importance	cell importance
6	NPE	weight cutoff	weight cutoff
7	NPE	energy importance	energy importance
8	NP	DXTRAN	DXTRAN
9	NP	forced collisions	forced collisions
10	NP	exponential transform	exponential transform

For neutrons only

11	N	upscattering	downscattering
12	N		capture
13	N	(n,xn)	loss to (n,xn)
14	N	fission	loss to fission
16	N	alpha <0 time creation	alpha >0 absorption

For photons only

11	P	from neutrons	Compton scatter
12	P	bremsstrahlung	capture
13	P	p-annihilation	pair production
14	P	electron x-rays	
15	P	1st fluorescence	
16	P	2nd fluorescence	

For electrons only

11	E	pair production	scattering
12	E	Compton recoil	bremsstrahlung
13	E	photo-electric	
14	E	photon auger	
15	E	electron auger	
16	E	knock-on	

For the printed table, the weight totals are divided by the number of histories and the energy totals are divided by the total weight of source particles.

**APPENDIX E**  
**SOME IMPORTANT COMPLICATED ARRAYS**

PAC(MIPT,10,MXA) Array Problem Activity in Each Cell

The value of PAC(LPAC+I,J,K) is the total of type J data for particle type I in cell K. If a particle becomes lost, a small amount of erroneous information gets added into PAC.

<u>J</u>	
1	number of tracks entering cell K
2	population of cell K: the number of tracks, including source tracks,, entering for the first time
3	number of collisions in cell K
4	weight entering collisions
5	energy * time interval in cell K * weight
6	energy * path length * weight
7	path length in cell K
8	mean free path * path length * weight
9	time interval * weight
10	path length * weight

The quantities printed are

- Tracks Entering = PAC(LPAC+I,1,K)
- Population = PAC(LPAC+I,2,K)
- Collisions = PAC(LPAC+I,3,K)
- Collisions \* weight (per history) = PAC(LPAC+I,4,K) / number of histories
- Number Weighted Energy = PAC(LPAC+I,5,K) / PAC(LPAC+I,9,K)
- Flux Weighted Energy = PAC(LPAC+I,6,K) / PAC(LPAC+I,10,K)
- Average Track Weight (Relative) = PAC(LPAC+I,10,K) \* importance of cell K / [PAC(LPAC+I,7,K) \* importance of source cell]
- Average Track MFP = PAC(LPAC+I,8,K) / PAC(LPAC+I,10,K)

PWB(MIPT,20,MXA) Array Weight Balance in Each Cell

The value of PWB(LPWB+I,J,K) is the net weight change of type J for particle type I in cell K. If a particle becomes lost, a small amount of erroneous information gets added into PWB. Table values are divided by the number of histories before being printed.

<u>J</u>	<u>Table Heading</u>	
	<u>External</u>	
1	Entering	weight of particles entering cell K
2	Source	weight of created source particles
3	Time Cutoff	weight of particles killed by time cutoff
4	Energy Cutoff	weight of particles killed by energy cutoff
5	Exiting	weight of particles exiting cell K
20	Alpha	weight of alpha time creation/absorption

**APPENDIX E**  
**SOME IMPORTANT COMPLICATED ARRAYS**

	<u>Variance Reduction</u>	
6	Weight Window	net weight change due to weight-window Russian roulette
7	Cell Importance	net weight change due to splitting and Russian roulette in importance sampling
8	Weight Cutoff	net weight change due to weight cutoff
9	Energy Importance	net weight change due to energy splitting and Russian roulette
10	DXTRAN	net weight change due to DXTRAN
11	Forced Collision	net weight change due to forced collision
12	Exponential Transform	net weight change due to exponential transform
	<u>Physical (neutrons)</u>	
13	(n,xn)	weight of new tracks produced by other nonfission processes
14	Fission	weight of fission neutrons produced
15	Capture	weight lost to capture
16	Loss to (n,xn)	weight of neutrons lost to (n,xn)
17	Loss to Fission	weight of neutrons lost to fission
	<u>Physical (photons)</u>	
13	From Neutrons	weight of neutron-induced photons
14	Bremsstrahlung	net weight created by bremsstrahlung
15	P-annihilation	net weight created by p-annihilation
16	Electron x-rays	net weight created by electron x-rays
17	Fluorescence	net weight created by double fluorescence
18	Capture	weight lost to capture
19	Pair Production	net weight created by pair production
	<u>Physical (electrons)</u>	
13	Pair production	net weight created by pair production
14	Compton recoil	net weight created by Compton scatter
15	Photo-electron	net weight created by photo-electrons
16	Photon Auger	net weight created by photon auger
17	Electron Auger	net weight created by electron auger
18	Knock-on	net weight created by knock-ons

PAN(2,6,NPN) Array Activity of Each Nuclide in Each Cell

The value of  $PAN(LPAN+I,J,IPAN(LIPA+K)+N-1)$  is the total of type J data for particle type I for the Nth nuclide in cell K.  $IPAN(LIPA+M+1) = IPAN(LIPA+M) +$  number of nuclides in the material of cell M.  $IPAN(LIPA+1) = 1$  and  $NPN = IPAN(LIPA+MXA+1) - 1$ . If a particle becomes lost, a small amount of erroneous information gets added into PAN.

J (for neutrons)

- 1 number of collisions with Nth nuclide of cell K
- 2 weight entering collisions
- 3 weight lost to capture
- 4 weight gain by fission
- 5 weight gain by other inelastic processes
- 6 unused

J (for photons)

- 1 number of collisions with Nth nuclide of cell K
- 2 weight entering collisions
- 3 weight lost to capture
- 4 number of neutron-induced photons
- 5 weight of neutron-induced photons
- 6 energy \* weight of neutron-induced photons

The quantities printed are

Total Collisions = PAN(LPAN+I,1,L)

Collisions \* Weight = PAN(LPAN+I,2,L) / number of histories

Weight Lost to Capture = PAN(LPAN+I,3,L) / number of histories

Weight Gain by Fission = PAN(LPAN+1,4,L) / number of histories

Weight Gain by (n,xn) = PAN(LPAN+1,5,L) / number of histories

Total From Neutrons = PAN(LPAN+2,4,L)

Weight from Neutrons = PAN(LPAN+2,5,1) / number of histories

Avg Photon Energy = PAN(LPAN+2,6,L) / PAN(LPAN+2,5,L)

PCC(3,MXA) Array Summary of Photons Produced in Neutron Collisions

The value of PCC(LPCC+J,K) is the total of type J data for cell K. If a particle becomes lost, a small amount of erroneous information may be added into PCC.

J

- 1 number of neutron-induced photons
- 2 weight of neutron-induced photons
- 3 weight \* energy of neutron-induced photons

The quantities printed are

Number of Photons = PCC(LPCC+1,K)

Weight Per Source Neutron = PCC(LPCC+2,K) / number of histories

Energy Per Source Neutron = PCC(LPCC+3,K) / number of histories

Avg Photon Energies = PCC(LPCC+3,K) / PCC(LPCC+2,K)

Energy/Gram Per Source Neutron = PCC(LPCC+3,K) /

[cell mass \* number of histories]

Weight/Neutron Collision = PCC(LPCC+2,K) / PAC(LPAC+1,4,K)

Energy/Neutron Collision = PCC(LPCC+3,K) / PAC(LPAC+1,4,K)

## APPENDIX E SOME IMPORTANT COMPLICATED ARRAYS

### FEBL(2,K) Array Summary of Photons Produced in Neutron Collisions

The value of FEBL(J,K) is the total of type J data for photon energy bin K, where K=16 for continuous energy problems and K=IGM=number of multigroup energy groups. The energy bin bounds are in array EBL(K) in common block /TABLES/.

<u>J</u>	
1	number of neutron-induced photons
2	weight of neutron-induced photons

The quantities printed are

Number of Photons = FEBL(1,K)  
Number Frequency = FEBL(1,K) / PAX(2,1,3)  
Weight of Photons = FEBL(2,K) / number of histories  
Weight Frequency = FEBL(2,K) / PAX(2,2,3)

### **E. KCODE Arrays**

OSUM(I) Array Cumulative  $k_{eff}$  over active cycles  
OSUM(I) = OSUM(I) + SUMK(I)/NSRCK, I=1,3.

OSUM2(I,J) Array Cumulative  $k_{eff}$  covariance quantities  
OSUM2(I,J) = OSUM2(I,J) + ZZ(I) \* ZZ(J)  
where ZZ(K) = SUMK(K)/NSRCK.

RLT(I,J) Array Prompt removal lifetimes for current active cycle  
RLT(I,J) Prompt removal lifetimes for current active cycle.  
I = 1/2/3/4 = collision/absorption/track length/fission  
J = 1 sum of WGT\*TME over cycle  
J = 2 sum of WGT over cycle  
Note: RLT(4,1) is summed over all histories and used only for the fission lifespan.  
RLT(4,2) unused.

### RKPL(19,MRKP) Array KCODE Quantities for Plotting

The value of RKPL(LRKP+I,J) for the Jth cycle of a KCODE or ACODE problem:

<u>J</u>	
1	$k_{eff}$ (collision)
2	$k_{eff}$ (absorption)
3	$k_{eff}$ (track length)
4	prompt removal life (collision)

**APPENDIX E**  
**SOME IMPORTANT COMPLICATED ARRAYS**

- 5 prompt removal life (absorption)
- 6 average collision  $k_{eff}$
- 7 average collision  $k_{eff}$  standard deviation
- 8 average absorption  $k_{eff}$
- 9 average absorption  $k_{eff}$  standard deviation
- 10 average track length  $k_{eff}$
- 11 average track length  $k_{eff}$  standard deviation
- 12 average col/abs/trk-len  $k_{eff}$
- 13 average col/abs/trk-len  $k_{eff}$  standard deviation
- 14 average col/abs/trk-len  $k_{eff}$  by cycles skipped
- 15 average col/abs/trk-len  $k_{eff}$  by cycles skipped standard deviation
- 16 prompt removal lifetime (col/abs/trk-len)
- 17 prompt removal lifetime (col/abs/trk-len) standard deviation
- 18 number of histories used in each cycle
- 19 col/abs/trk-len  $k_{eff}$  figure of merit

The value of RKPL(LRKP+I,J) for the Jth cycle of an ACODE problem:

- 20 imposed alphas vs. cycle number
- 21 imposed delta alpha vs cycle number (i.e., how much alpha is incremented each cycle)
- 22 average imposed alpha vs. cycle
- 23 relative error on average alpha vs. cycle number
- 24 average delta alpha vs. cycle number (should approach zero)
- 25 standard deviation of delta alpha vs. cycle number
- 26 ln-ln regression fit alpha vs. cycle number
- 27 linear regression fit alpha using  $\alpha = a + b * k_{eff}$  vs. cycle number
- 28 linear regression fit alpha using  $k_{eff} = a + b * \alpha$  vs. cycle number
- 29 alpha figure of merit (fom) vs. cycle number
- 30 alpha vs. the  $k_{eff}$  estimator used to estimate alpha
- 31  $k_{eff}$  estimator to estimate alpha vs. alpha
- 32 linear estimate of  $d\alpha/dk_{eff}$  (should be negative) vs. cycle number
- 33 ln-ln estimate of  $d\alpha/dk_{eff}$  (should be negative) vs. cycle number
- 34 alpha values by alpha cycles skipped vs. cycles skipped ( $k_{eff}$  cycle kalsav+1 is zero alpha cycles skipped)
- 35 alpha relative error by cycles skipped vs cycles skipped

RSUM(I) Array Cumulative prompt removal lifetimes over active cycles  
 $RSUM(I) = RSUM(I) + RLT(I,1)/RLT(I,2), I=1,3.$

RSUM2(I,J) Array Cumulative prompt removal lifetime covariance quantities  
 $RSUM2(I,J) = RSUM2(I,J) + RL(I) * RL(J)$   
 where  $RL(K) = RLT(K,1)/RLT(K,2).\{cr\}$

**APPENDIX E**  
**SOME IMPORTANT COMPLICATED ARRAYS**

SUMK(I) Array SUMK(I)/NSRCK is  $k_{eff}$  for current cycle  
 $I = 1/2/3 =$  collision/absorption/track length

SUMP(3\*NPERT) Array Track length estimate of  $k_{eff}$  for each perturbation, IP=1, NPERT  
 SUMP(IP) track length estimate of  $k_{eff}$  for current cycle  
 SUMP(NPERT+IP) cumulative SUMP(IP) over all cycles  
 SUMP(2\*NPERT+IP) cumulative SUMP(IP)\*\*2 to get standard deviations  
 SUMP(LSUM+IP), IP=1, NPERT is like SUMK(3)  
 SUMP(LSUM+NPERT+IP) is like OSUM(3)  
 SUMP(LSUM+2\*NPERT+IP) is like OSUM2(3,3)

In multitasking, SUMP(KSUM+IP) is accumulated into SUMP(LSUM+IP), but there is no need for nor space saved for SUMP(KSUM+NPERT+IP) or SUMP(KSUM+2\*NPERT+IP).

**F. Alpha Arrays**

ALFA(1) Collision estimate of alpha generation time  
 ALFA(2) 1st order change in alfa(1) (<0)  
 ALFA(3) 2nd order change in alfa(1) (>0)

ALPHA(1) Imposed alpha for current cycle  
 ALPHA(2) Unused  
 ALPHA(3) Sum of  $k_{eff}$  (alpha)  
 ALPHA(4) Sum of alpha(1)  
 ALPHA(5) Sum of alpha(1) \*  $k_{eff}$  (alpha)  
 ALPHA(6) Sum of  $k_{eff}$  (alpha)\*\*2  
 ALPHA(7) Sum of alpha(1)\*\*2  
 ALPHA(8) Sum of delta alpha  
 ALPHA(9) Sum of (delta alpha)\*\*2  
 ALPHA(10) Sum of x1; x1 = log( $k_{eff}$  (alpha))  
 ALPHA(11) Sum of al; al = max(log(alpha(1)), log(1e-3))  
 ALPHA(12) Sum of al\*x1  
 ALPHA(13) Sum of x1\*\*2

**G. Universe Map/ Lattice Activity Arrays for Table 128**

MAZP(3, MXA) Array Used in RSLMAZ to point inside MAZE array.  
 MAZP(1, IC) = I, index of cell IC in MAZU(j) list.  
 MAZP(2, IC) = universe address J of cell IC.  
 MAZP(3, IC) = address J of universe filling cell IC.

MAZU(NMZU) Array Used in RSLMAZ to point inside MAZE array. The MAZE(NMAZ) array contains the number of sources, tracks entering and collisions in each repeated structures/lattice element for each

- MAZU(J-3) = I = universe name.
- MAZU(J-2) = finite lattice cell filling universe I.
- MAZU(J-1) = total number of lowest level elements below U=I.
- MAZU(J) = NE = number of cells/elements in universe I.
- MAZU(J+K) = number of elements below Kth cell/universe.
- MAZU(J+NE+K) = Kth cell in universe I (repeated structures).
- MAZU(J+NE+K) = first cell of universe filling Kth lattice element.

**H. Weight Window Mesh Parameters**

- WWM(1-3) total number of fine meshes in x,y,z or r,z,theta directions
- WWM(4-6) origin (corner of box for rectangular geometry, bottom & center point for cylindrical geometry)
- WWM(7-9) number of coarse meshes in each direction
- WWM(10-12) cylindrical geometry top center point
- WWM(13-15) cylindrical geometry point on radius and bottom plane
- WWM(16-18) cylindrical geometry direction cosines from bottom center point to point on radius
- WWM(19) cylindrical geometry radius
- WWM(20-22) cylindrical geometry cosines of axis
- WWM(23) cylindrical geometry axis length
- WWM(24-26) cylindrical geometry direction cosines of the cross product of the radial direction and axial direction; necessary for full revolution theta determination
- WGM(NWGM) weight window mesh geometric data with the inclusion of 0th index entries for each dimension. The data are stored as cumulative values.

**I. Perturbation Parameters**

DPTB(3,NPERT\*MNNM) Array PERT card density changes which become the perturbation coefficients fixed at code initiation. For each nuclide, J, of perturbation IP where  $J=NPTB(IP), NPTB(IP+1)+1$ , DPTB(LDPT+I,J) has the following values:

<u>I</u>	<u>Description</u>
1	nuclide index, IEX
2	$\delta_1 \Delta v$
3	$\delta_2 \Delta v$



## APPENDIX E

### SOME IMPORTANT COMPLICATED ARRAYS

where  $\Delta v$  is the density change term (see page 2-192) of the Taylor Series expansion.  $\delta_1 = 1/0$  if the 1st order perturbation is on (METHOD=1,2) or off.  $\delta_2 = 1/0$  if the 2nd order perturbation is on (METHOD=1,3) or off.

IPTB(2+2\*NPKEY,NPERT) Array Pointers to RPTB array and other perturbation parameters from PERT card.

The 6 NPKEY perturbation key words are CELL, MAT, RHO, RXN, ERG and METHOD. For perturbation IP=1,NPERT,

IPTB(LIPB+1,IP) = perturbation number from PERT card  
 IPTB(LIPB+2,IP) = particle type from PERT card  
 IPTB(LIPB+1+2\*K,IP) = number of entries for keyword K  
 IPTB(LIPB+2+2\*K,IP) = location in RPTB of PERT card data for keyword K

Exception:

IPTB(LIPB+13,IP) = 1/2/3 = METHOD  
 IPTB(LIPB+14,IP) = 0 for method = 1/2/3;  
                           = 1 for METHOD = -1/-2/-3

Example: PERT6:N,P CELL 7 8 9 12 METHOD = -2  
 IPTB = 6 3 4 12345 00 00 00 00 2 1  
 RPTB(12345) = 7. 8. 9. 12.

NPTB(NPERT+1) Array Cumulative number of perturbed cross sections used as pointers to DPTB and PTB arrays. NPTB(IP) points to the first nuclide data in DPTB and PTB for the material of perturbation IP. Thus perturbation IP has  $NPTB(IP+1) - NPTB(IP) \leq MNNM$  nuclides in its perturbed material, and the entries in the PTB and RPTB arrays for these nuclides are stored from NPTB(IP) to NPTB(IP+1) - 1.

PTB(5,NPERT\*MNNM) Array Perturbation coefficients. The perturbation coefficients  $P_{1j'}$  and  $P_{2j'}$  described in Chapter 2 (see page 2-198) are stored in the PTB(LPTB+I,J) array where  $J=NPTB(IP), NPTB(IP+1) - P1$  for the NPTB(IP+1) - NPTB(IP) nuclides of perturbation IP.

PTB(KPTB+1,J) =  $P_{1j'}$   
 PTB(KPTB+2,J) =  $P_{2j'}$   
 PTB(KPTB+3,J) =  $x_b(E')$  the macroscopic cross section nuclide J at  $E'$   
 PTB(KPTB+4,IP) =  $P_{1j'} \Delta v + \frac{1}{2} (P_{2j'} + P_{1j'}^2 \Delta v^2)$   
 PTB(KPTB+5,J) =  $x_c(E)$

The perturbed value of  $k_{eff}$  or a tally is then the unperturbed value times PTB(KPTB+4,IP). If the nuclides in the perturbation are also in the tally (F6, F7, or F4 with FM card with negative constant for atom density multiplier), then PTB(KPTB+4,IP) is corrected by adding  $R_{Ij}\Delta v + P_{Ij}R_{Ij}\Delta v^2$  where

$$R_{1j'} = \frac{\sum_{c \in B} \sum_{E \in H} x_c(E)}{\sum_{c \in C} x_c(E)} = \frac{\sum_J \text{PTB}(KPTB+5,J)}{\text{PTBTC}}$$

Note that  $x_b(E)$  at collision  $k$  is saved as PTB(KPTB+3,J) to be used as  $x_b(E')$  at collision  $k+1$ . Also note that PTB(KPTB+4,IP) is stored by perturbation number IP, not J like the rest of the PTB array, leaving NPRT\*MNNM - NPRT words unused.

RPTB(IPERT) Array Perturbation parameters from PERT card. RPTB(LRPT+I) stores the keywords read from the PERT card as pointed by the IPTB array (see above).

**J.    *Macrobody and Identical Surface Arrays***

- IDNA(K)    exactly parallels the LJA(K) array for cell cards  
               = 0 when slot k does not involve a macrobody surface  
               = n with n>0, is facet n of macrobody  
               =-n is facet, but cell card is only using this one facet
- IDNT(J)    program surface number of master identical surface  
               = 0, j is not an identical surface  
               = j', |j'| is the master surface of identical surfaces. The sense gives the sense of surface j with respect to the sense of the master surface j'
- IDNS(J)    locator in IDNE for list of identical surfaces  
               =0 no identical surfaces  
               =m with m locator in IDNE
- IDNE(M)    list of identical surfaces  
               =n number of identical surfaces for surface j  
               next n entries are the identical program surfaces (j's)  
               IDNE(1) is the number of identical surface sets  
               IDNE(2) is the total length of IDNE

## APPENDIX F

### DATA TABLE FORMATS

MCNP has two *types* and eight *classes* of data. These data are kept in individual *tables* that are often organized into *libraries*. These tables are located with the XSDIR data directory file. These terms, tables, and the basic data table formats are described in this appendix in the following sections:

		<u>Page</u>
I.	Data Types and Classes	F-1
II.	XSDIR – Data Directory File	F-2
III.	Data Tables	F-4
IV.	Data Blocks for Neutron Continuous–Energy and Discrete Transport Tables	F-12
V.	Data Blocks for Dosimetry Tables	F-34
VI.	Data Blocks for Thermal $S(\alpha,\beta)$ Tables	F-35
VII.	Data Blocks for Photon Transport Tables	F-38
VIII.	Format for Multigroup Transport Tables	F-40
IX.	Data Blocks for Electron Transport Tables	F-52

#### ***I. DATA TYPES AND CLASSES***

MCNP reads eight *classes* of data from two *types* of data tables. The two types of data tables are:

1. Type 1—standard formatted tables (sequential, 80 characters per record). These portable libraries are used to transmit data from one installation to another. They are bulky and slow to read. Few installations use Type 1 tables in MCNP directly. Most generate Type 2 tables from Type 1 tables using the MAKXSf code (see Appendix C).
2. Type 2—standard unformatted tables (direct-access, binary) locally generated from Type 1 tables. They are not portable except between similar systems such as various UNIX platforms. Type 2 tables are used most because they are more compact and faster to read than Type 1 tables.

Data tables exist for eight *classes* of data: continuous-energy neutron, discrete-reaction neutron, continuous-energy photon interaction, continuous-energy electron interaction, neutron dosimetry,  $S(\alpha,\beta)$  thermal, neutron multigroup, and photon multigroup. A user should think of a data table as an entity that contains evaluation-dependent information about one of the eight *classes* of data for a specific target isotope, element, or material. For how the data are used in MCNP, a user does not need to know whether a particular table is in Type 1 or Type 2. For any Zaid, the data contained

## APPENDIX F

### XSDIR— DATA DIRECTORY FILE

on Type 1 and Type 2 tables are identical. Problems run with one data type will track problems run with the same data in another format type.

When we refer to data libraries, we are talking about a series of data tables concatenated into one file. All tables on a single library must be of the same *type* but not necessarily of the same *class*. For example, the Type 1 library for the MCNP test set contains six *classes* of data. There is no reason, other than convenience, for having data libraries; MCNP could read exclusively from individual data tables not in libraries.

## II. XSDIR— DATA DIRECTORY FILE

MCNP determines where to find data tables for each ZAID in a problem based on information contained in a system-dependent directory file XSDIR. The directory file is a sequential formatted ASCII file with 80-character records (lines) containing free-field entries delimited by blanks.

The XSDIR file has three sections. In the first section, the first line is an optional entry of the form:

$$\text{DATAPATH} = \text{datapath}$$

where the word DATAPATH (optionally capitalized) must start in column 1.

The = sign is optional. The directory where the data libraries are stored is *datapath*. The xmdir directory file can be renamed by item 1. The search hierarchy to find the data libraries is:

1. xmdir= cross-section directory file name on the MCNP execution line;
2. DATAPATH = *datapath* in the INP file message block;
3. the current directory;
4. the DATAPATH entry on the first line of the XSDIR file;
5. the unix environmental variable setenv DATAPATH *datapath*;
6. the individual data table line in the XSDIR file (see below under Access route); or
7. the directory specified at MCNP compile time in the BLOCK DATA subroutine.

The second section of the XSDIR file is the atomic weight ratios. This section starts with the words "ATOMIC WEIGHT RATIOS" (capitalization optional) beginning in column 1. The following lines are free-format pairs of ZAID AWR, where ZAID is an integer of the form ZZAAA and AWR is the atomic weight ratio. These atomic weight ratios are used for converting from weight fractions to atom fractions and for getting the average Z in computing electron stopping powers. If the atomic weight ratio is missing for any nuclide requested on an Mn card, it must be provided on the AWTAB card.

The third section of the XSDIR file is the listing of available data tables. This section starts with the word “DIRECTORY” (capitalization optional) beginning in column 1. The lines following consist of the seven- to ten-entry description of each table. The ZAID of each table must be the first entry. If a table requires more than one line, the continuation is indicated by a + at the end of the line. A zero indicates the entry is inapplicable. Unneeded entries at the end of the line can be omitted.

The directory file has seven to eleven entries for each table. They are:

1.	Name of the table	character * 10
2.	Atomic weight ratio	real
3.	File name	character
4.	Access route	character * 70
5.	File type	integer
6.	Address	integer
7.	Table length	integer
8.	Record length	integer
9.	Number of entries per record	integer
10.	Temperature	real
11.	Probability table flag	character

1. Name of the Table. This is usually the ZAID: 3 characters for Z, 3 characters for A, a decimal point, 2 characters for evaluation identification, and a tenth character used to identify continuous energy tables by the letter C, discrete-reaction tables by D, dosimetry tables by Y, S( $\alpha,\beta$ ) thermal tables by T, continuous-energy photon tables by P, continuous-energy electron tables by E, multigroup neutron tables by M, and multigroup photon tables by G. For the S( $\alpha,\beta$ ) tables, the first 6 characters contain a mnemonic character string, such as LWTR.01T.
2. Atomic Weight Ratio. This is the atomic mass divided by the mass of a neutron. The atomic weight ratio here is used only for neutron kinematics and should be the same as it appears in the cross-section table so that threshold reactions are correct. It is the quantity *A* used in all the neutron interaction equations of Chapter 2. This entry is used only for neutron tables.
3. File Name. The file name is the name of the library that contains the table and is a string of eight characters in a form allowed by the local installation.
4. Access Route. The access route is a string of up to 70 characters that tells how to get ahold of the file if it is not already accessible. At Los Alamos on UNICOS, it is a CFS path name. On other systems it might be a UNIX directory path. If there is no access route, this entry is zero.
5. File Type. 1 or 2.
6. Address. For Type 1 files the address is the line number in the file where the table starts. For Type 2 files, it is the record number of the first record of the table.

## APPENDIX F DATA TABLES

7. Table Length. A data table consists of two blocks of information. The first block is a collection of pointers, counters, and character information. The second block is a solid sequence of numbers. For Type 1 and Type 2 tables, the table length is the length (total number of words) of the second block.
8. Record Length. This entry is unused for Type 1 files and therefore is zero. For Type 2 direct access files it is the processor-dependent attribute called the record length. The record length is a multiple of the number of entries per record where the multiple is 1 for VMS and the multiple is the number of 8-bit bytes in the record for most other systems. Thus for 512 entries per record, the record length is 4096 for UNICOS, 4096 for double-precision data on unix workstations (electron data are always double precision on single-precision platforms), 2048 for single-precision data on unix workstations, etc.
9. Number of Entries per Record. This is unused for Type 1 files and therefore is zero. For Type 2 files it is the number of items per record in the second block of the table. Usually this entry is set to 512.
10. Temperature. The temperature in MeV at which a neutron table was processed. This entry is used only for neutron data.
11. Probability table flag. The character word "ptable" indicates a continuous-energy neutron nuclide has unresolved resonance range probability tables.

### ***III. DATA TABLES***

The remainder of this Appendix is designed for the user who wishes to know a great deal about how data are stored in data tables and in MCNP. First we describe how to find a specific table on a Type 1 or Type 2 library. Then we document the detailed format of the various blocks of information for each *class* of data.

Three arrays are associated with each data table. The NXS array contains various counters and flags. The JXS array contains pointers. The XSS array contains all of the data. These arrays are the same regardless of the *type* of a specific table. The arrays are manipulated internally by MCNP. Within a data table, the counter and pointer arrays are dimensioned to NXS(16) and JXS(32). In MCNP the same arrays are dimensioned to NXS(16,IEX) and JXS(32,IEX), where IEX is the index of the particular table in the problem. There is no limit to the number of tables or their size other than available space on a particular computing platform.

To locate data for a specific table (external to MCNP) it is necessary to extract several parameters associated with that table from the directory file XSDIR. The file name obviously indicates the name of the library that the table is stored on. Other important parameters from the viewpoint of this Appendix are file type (NTY), address (IRN), table length (ITL), and number of entries per record (NER).

**A. Locating Data on a Type 1 Table**

Because Type 1 tables are 80-character card-image files, the XSDIR address IRN is the line number of the first record, or the beginning, of the table. The first 12 records (lines) contain miscellaneous information as well as the NXS and JXS arrays. The format follows.

Relative	Address		Contents	Format
	Relative	Absolute		
1	IRN	IRN	HZ,AW(0),TZ,HD	A10,2E12.0,1X,A10
2	IRN+1	IRN+1	HK,HM	A70,A10
3-6	IRN+2	IRN+2	(IZ(I),AW(I),I=1,16)	4(I7,F11.0)
7-8	IRN+6	IRN+6	(NXS(I),I=1,16)	8I9
9-12	IRN+8	IRN+8	(JXS(I),I=1,32)	8I9

The variables are defined in Tables F.1–F.3 for neutron, photon, dosimetry and  $S(\alpha,\beta)$  thermal libraries. These variables are defined in TABLE F-32 and TABLE F-33 for multigroup data.

The XSS array immediately follows the JXS array. All data from the XSS array are read into MCNP with a 4E20.0 format. (When Type 1 tables are created, floating-point numbers are written in 1PE20.12 format and integers are written in I20 format.) The length of the XSS array is given by the table length, ITL, in the directory (also by NXS(1) in the table itself). The number of records required for the XSS array is  $(ITL+3)/4$ . A Type 1 library is shown in Figure F-1.

**Layout of a Type 1 Library**

Starting Address (Line Number)	Number of Records	Contents
IRN <sub>1</sub> =1	12	misc. including NXS <sub>1</sub> , JXS <sub>1</sub>
IRN <sub>1</sub> +12	$(ITL_1+3)/4$	XSS <sub>1</sub>
IRN <sub>2</sub>	12	misc. including NXS <sub>2</sub> , JXS <sub>2</sub>
IRN <sub>2</sub> +12	$(ITL_2+3)/4$	XSS <sub>2</sub>
⋮	⋮	⋮
IRN <sub>n</sub>	12	misc. including NXS <sub>n</sub> , JXS <sub>n</sub>
IRN <sub>n</sub> +12	$(ITL_n+3)/4$	XSS <sub>n</sub>

IRN<sub>i</sub>, ITL<sub>i</sub> are the addresses and tables lengths from XSDIR  
n=number of tables contained on library

**Figure F-1.**

**APPENDIX F  
DATA TABLES**

**TABLE F-1  
Definition of the NXS Array**

NTY	1 or 2 Continuous energy or Discrete reaction Neutron	3 Dosimetry	4 Thermal	5 Continuous energy Photon
NXS(1)	Length of second block of data	Length of second block of data	Length of second block of data	Length of second block of data
NXS(2)	ZA=1000*Z+A	ZA=1000*Z+A	IDPNI=inelastic scattering mode	Z
NXS(3)	NES=number of energies		NIL=inelastic dimensioning parameter	NES=number of energies
NXS(4)	NTR=number of reactions excluding elastic	NTR=number of reactions	NIEB=number of inelastic exiting energies	NFLO=length of the fluorescence data divided by 4
NXS(5)	NR=number of reactions having secondary neutrons excluding elastic		IDPNC=elastic scattering mode	
NXS(6)	NTRP=number of photon production reactions		NCL=elastic dimensioning parameter	
NXS(7)			IFENG=secondary energy mode	
NXS(8)	NPCR=number of delayed neutron precursor families			
.....				
.....				
.....				
NXS(15)	NT=number of PIKMT reactions			
NXS(16)	0=normal photon production -1=do not produce photons			

Note that many variables are not used, allowing for expansion in the future.



**TABLE F-2  
Definition of the JXS Array**

NTY	1 or 2 Continuous energy or Discrete reaction Neutron	3 Dosimetry	4 Thermal	5 Continuous energy Photon
JXS(1)	ESZ=location of energy table	LONE=location of first word of table	ITIE=location of inelastic energy table	ESZG=location of energy table
JXS(2)	NU=location of fission nu data		ITIX=location of inelastic cross sections	JINC=location of incoherent form factors
JXS(3)	MTR=location of MT array	MTR=location of MT array	ITXE=location of inelastic energy/angle distributions	JCOH=location of coherent form factors
JXS(4)	LQR=location of Q-value array		ITCE=location of elastic energy table	JFLO=location of fluorescence data
JXS(5)	TYR=location of reaction type array		ITCX=location of elastic cross sections	LHNM=location of heating numbers
JXS(6)	LSIG=location of table of cross-section locators	LSIG=location of table of cross-section locators	ITCA=location of elastic angular distributions	
JXS(7)	SIG=location of cross sections	SIGD=location of cross sections		
JXS(8)	LAND=location of table of angular distribution locators			
JXS(9)	AND=location of angular distributions			
JXS(10)	LDLW=location of table of energy distribution locators			
JXS(11)	DLW=location of energy distributions			

**APPENDIX F  
DATA TABLES**

**TABLE F-2 (Cont.)  
Definition of the JXS Array**

JXS(12)	GPD=location of photon production data	
JXS(13)	MTRP=location of photon production MT array	
JXS(14)	LSIGP=location of table of photon production cross-section locators	
JXS(15)	SIGP=location of photon production cross sections	
NXS(16)	LANDP=location of table of photon production angular distribution locators	
JXS(17)	ANDP=location of photon production angular distributions	
JXS(18)	LDLWP=location of table of photon production energy distribution locators	
JXS(19)	DLWP=location of photon production energy distributions	
JXS(20)	YP=location of table of yield multipliers	
JXS(21)	FIS=location of total fission cross section	
JXS(22)	END=location of last word of this table	END=location of last word of this table
JXS(23)	LUNR=location of probability tables	
JXS(24)	DNU=location of delayed nubar data	

**TABLE F-2 (Cont.)**  
**Definition of the JXS Array**

JXS(25) BDD=location of basic  
delayed data ( $\lambda$ 's,  
probabilities)

JXS(26) DNEDL=location of  
table of energy  
distribution locators

JXS(27) DNED=location of  
energy distributions

.....

JXS(32)

Note that many variables are not used, allowing for easy expansion in the future.

All pointers in the JXS array refer to locations in the XSS array.

JXS(1) always points to the first entry in the second block of data.

**TABLE F-3**  
**Definition of Miscellaneous Variables on Data Tables**

HZ—10 character name (ZAID) of table. The form of HZ is

ZZZAAA.nnC	continuous-energy neutron
ZZZAAA.nnD	discrete-reaction neutron
ZZZAAA.nnY	dosimetry
XXXXXX.nnT	thermal $S(\alpha, \beta)$
ZZZ000.nnP	continuous-energy photon
ZZZ000.nnM	neutron multigroup
ZZZ000.nnG	photon multigroup
ZZZ000.nnE	continuous-energy electron

where ZZZ is the atomic number

AAA is the mass number

XXXXXX for thermal data is a Hollerith name or abbreviation of the material

nn is the evaluation identifier

AW(0)—atomic weight ratio; the atomic weight divided by the mass of a neutron

TZ—temperature at which the data were processed (in MeV)

HD—10-character date when data were processed

HK—70-character comment

HM—10-character MAT identifier

**APPENDIX F  
DATA TABLES**

**TABLE F-3 (Cont.)**

**Definition of Miscellaneous Variables on Data Tables**

(IZ(I),AW(I),I=1,16)—16 pairs of ZZZAAAs and atomic weight ratios. In the past these were needed for photon tables but are now ignored. The IZ entries are still needed for thermal tables to indicate for which isotope(s) the scattering data are appropriate.

**B. Locating Data on a Type 2 Table**

A standard unformatted file consists of many records, each with NER entries, where NER is the number of entries per record defined on XSDIR. A Type 2 data table consists of one record that contains pointers, counters, and character information, followed by one or more records containing the XSS array.

The information contained in the first record for each table is the same as that contained in the first twelve lines of a Type 1 table described above. The variables, in order, are HZ, AW(0), TZ, HD, HK, HM, (IZ(I),AW(I),I=1,16), (NXS(I),I=1,16), (JXS(I),I=1,32). The variables are defined in Tables F.1–F.3. HZ, HD, and HM are 10-character variables and HK is a 70-character variable. Floating-point variables may be double precision in some cases. The number of words contained in this “package” of information is therefore different for different computing systems. The remainder of the first record is empty. The next NREC records ( $NREC \geq 1$ ) contain the XSS data array, with  $NREC = (ITL + NER - 1) / NER$ , where ITL is the table length. A Type 2 library is shown in Figure F-2.

**Layout of a Type 2 Library**

Address	Contents	
IRN <sub>1</sub> = 1	misc. including NXS <sub>1</sub> , JXS <sub>1</sub>	
2	XSS <sub>1</sub>	NER < ITL <sub>1</sub> ≤ 2*NER
3	XSS <sub>1</sub> (cont)	
IRN <sub>2</sub> = 4	misc. including NXS <sub>2</sub> , JXS <sub>2</sub>	
5	XSS <sub>2</sub>	ITL <sub>2</sub> ≤ NER
⋮	⋮	⋮
⋮	⋮	⋮
IRN <sub>n</sub> = MAX–3	misc. including NXS <sub>n</sub> , JXS <sub>n</sub>	
MAX–2	XSS <sub>n</sub>	
MAX–1	XSS <sub>n</sub> (cont)	2*NER < ITL <sub>n</sub> ≤ 3*NER
MAX	XSS <sub>n</sub> (cont)	

(Records per table are examples only)

n=number of tables contained on library

MAX=number of records contained on library

IRN<sub>i</sub>, ITL<sub>i</sub>, NER are the addresses, table lengths, and entries per record from XSDIR

**Figure F-2.**

**C. Locating Data Tables in MCNP**

The NXS and JXS arrays exist in MCNP for each data table. The information contained in the (2-dimensional) arrays in MCNP mirrors the information contained in NXS and JXS (1-dimensional) on the individual tables. The current dimensions are NXS(16) and JXS(32) on the data tables and NXS(16,∞) and JXS(32,∞) in MCNP, where ∞ indicates variable dimensioning. In the code, the arrays are usually referenced as NXS(I,IEX) and JXS(I,IEX), where IEX is the index to a particular table.

The data from all cross-section tables used in an MCNP problem are in the XSS array, a part of dynamically allocated common. The data from the first table appear first, followed by the data from the second table, etc., as shown in Figure F-3. The pointers in the JXS array indicate absolute locations in the XSS array.

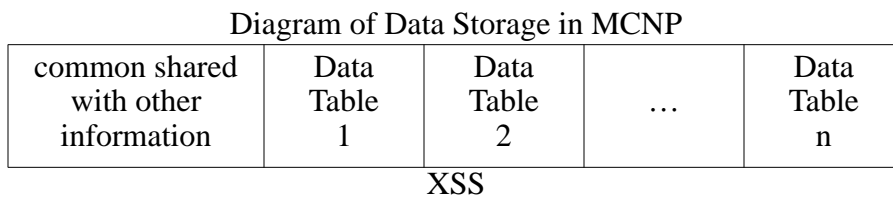

**Figure F-3.**

The definitions of the variables in the NXS and JXS arrays (TABLE F-1 and TABLE F-2) are the same in MCNP as on a data table with one exception. For discrete-reaction neutron tables, NXS(16,IEX) is used in MCNP as an indicator of whether discrete tables in a problem have cross sections tabulated on identical energy grids. Although the definitions of the variables are the same, the contents are generally not. Pointers in the JXS array are pointing to locations in the MCNP internal XSS array that are different from the locations in the data table XSS array. Flags in the NXS array will generally retain the same value in MCNP. Counters in the NXS array may retain the same value, primarily depending on the degree to which MCNP is able to expunge data for a particular problem.

**D. Individual Data Blocks**

Several blocks of data exist for every cross-section table. The format of an individual block is essentially the same in MCNP as on a data table. In either case, the absolute location of a data block in the XSS array is determined by pointers in the JXS array. The specific data blocks available for a particular table are a function of the *class* of data. We next describe the detailed format of individual data blocks for each *class* of data.

## APPENDIX F

### DATA BLOCKS FOR CONTINUOUS/DISCRETE NEUTRON TRANSPORT TABLES

#### *IV. DATA BLOCKS FOR CONTINUOUS/DISCRETE NEUTRON TRANSPORT TABLES*

The format of individual data blocks found on neutron transport tables is identical for continuous-energy (NTY=1) and discrete-reaction (NTY=2) tables. Therefore, the format for both are described in this section. All data blocks are now listed with a brief description of their contents and the table numbers in which their formats are detailed.

**\*\*Note:** In the tables that follow these descriptions, it is understood that NXS(I) or JXS(I) really means NXS(I,IEX) or JXS(I,IEX) when locating data blocks in MCNP.

1. ESZ Block—contains the main energy grid for the table and the total, absorption, and elastic cross sections as well as the average heating numbers. The ESZ Block always exists. See TABLE F-4.
2. NU Block—contains prompt, delayed and/or total  $\bar{\nu}$  as a function of incident neutron energy. The NU Block exists only for fissionable isotopes (that is, if JXS(2)  $\neq$  0). See TABLE F-5.
3. MTR Block—contains list of ENDF/B MT numbers for all neutron reactions other than elastic scattering. The MTR Block exists for all isotopes that have reactions other than elastic scattering (that is, all isotopes with NXS(4)  $\neq$  0). See TABLE F-6.
4. LQR Block—contains list of kinematic Q-values for all neutron reactions other than elastic scattering. The LQR Block exists if NXS(4)  $\neq$  0. See TABLE F-7.
5. TYR Block—contains information about the type of reaction for all neutron reactions other than elastic scattering. Information for each reaction includes the number of secondary neutrons and whether secondary neutron angular distributions are in the laboratory or center-of-mass system. The TYR Block exists if NXS(4)  $\neq$  0. See TABLE F-8.
6. LSIG Block—contains list of cross-section locators for all neutron reactions other than elastic scattering. The LSIG Block exists if NXS(4)  $\neq$  0. See TABLE F-9.
7. SIG Block—contains cross sections for all reactions other than elastic scattering. The SIG Block exists if NXS(4)  $\neq$  0. See TABLE F-10.
8. LAND Block—contains list of angular-distribution locators for all reactions producing secondary neutrons. The LAND Block always exists. See TABLE F-11.
9. AND Block—contains angular distributions for all reactions producing secondary neutrons. The AND Block always exists. See TABLE F-12.
10. LDLW Block—contains list of energy distribution locators for all reactions producing secondary neutrons except for elastic scattering. The LDLW Block exists if NXS(5)  $\neq$  0. See TABLE F-13.
11. DLW Block—contains energy distributions for all reactions producing secondary neutrons except for elastic scattering. The DLW Block exists if NXS(5)  $\neq$  0. See TABLE F-14.

## DATA BLOCKS FOR CONTINUOUS/DISCRETE NEUTRON TRANSPORT TABLES

12. GPD—contains the total photon production cross section tabulated on the ESZ energy grid and a 30X20 matrix of secondary photon energies. The GPD Block exists only for those older evaluations that provide coupled neutron/photon information (that is, if JXS(12)  $\neq$  0). See TABLE F-15.
13. MTRP Block—contains list of MT numbers for all photon production reactions. (We will use the term “photon production reaction” for any information describing a specific neutron-in photon-out reaction.) The MTRP Block exists if NXS(6)  $\neq$  0. See TABLE F-6.
14. LSI GP Block—contains list of cross-section locators for all photon production reactions. The LSI GP Block exists if NXS(6)  $\neq$  0. See TABLE F-9.
15. SIGP Block —contains cross sections for all photon production reactions. The SIGP Block exists if NXS(6)  $\neq$  0. See TABLE F-16.
16. LANDP Block—contains list of angular-distribution locators for all photon production reactions. The LANDP Block exists if NXS(6)  $\neq$  0. See TABLE F-17.
17. ANDP Block—contains photon angular distributions for all photon production reactions. The ANDP Block exists if NXS(6)  $\neq$  0. See TABLE F-18.
18. LDLWP Block—contains list of energy-distribution locators for all photon production reactions. The LDLWP Block exists if NXS(6)  $\neq$  0. See TABLE F-13.
19. DLWP Block—contains photon energy distributions for all photon production reactions. The DLWP Block exists if NXS(6)  $\neq$  0. See TABLE F-14.
20. YP Block—contains list of MT identifiers of neutron reaction cross sections required as photon production yield multipliers. The YP Block exists if NXS(6)  $\neq$  0. See TABLE F-19.
21. FIS Block—contains the total fission cross section tabulated on the ESZ energy grid. The FIS Block exists if JXS(21)  $\neq$  0. See TABLE F-20.
22. UNR Block—contains the unresolved resonance range probability tables. The UNR block exists if JXS(23)  $\neq$  0. See TABLE F-21.

**TABLE F-4**  
**ESZ Block**

<u>Location in XSS</u>	<u>Parameter</u>	<u>Description</u>
JXS(1)	E(I),I=1,NXS(3)	Energies
JXS(1)+NXS(3)	$\sigma_t(I),I=1,NXS(3)$	Total cross sections
JXS(1)+2*NXS(3)	$\sigma_a(I),I=1,NXS(3)$	Total absorption cross sections
JXS(1)+3*NXS(3)	$\sigma_{el}(I),I=1,NXS(3)$	Elastic cross sections
JXS(1)+4*NXS(3)	$H_{ave}(I),I=1,NXS(3)$	Average heating numbers

**APPENDIX F  
DATA BLOCKS FOR CONTINUOUS/DISCRETE NEUTRON TRANSPORT TABLES**

**TABLE F-5  
NU Block**

There are four possibilities for the NU Block:

1. JXS(2)=0                      no NU Block
2. XSS(JXS(2))>0            either prompt  $\bar{v}$  or total  $\bar{v}$  is given. The NU array begins at location XSS(KNU) where KNU=JXS(2).
3. XSS(JXS(2))<0            both prompt  $\bar{v}$  and total  $\bar{v}$  are given. The prompt NU Array begins at XSS(KNU) where KNU=JXS(2)+1; the total NU array begins at XSS(KNU), where KNU=JXS(2)+ABS(XSS(JXS(2)))+1.
4. JXS(24)>0                delayed  $\bar{v}$  is given. The  $\bar{v}$  array begins at XSS(KNU) where KNU=JXS(24). Delayed  $\bar{v}$  data must be given in form b).

The NU Array has two forms if it exists:

a) Polynomial function form of NU Array:

<u>Location in XSS</u>	<u>Parameter</u>	<u>Description</u>
KNU	LNU=1	Polynomial function flag
KNU+1	NC	Number of coefficients
KNU+2	C(I),I=1,NC	Coefficients

$$\bar{v}(E) = \sum_{I=1}^{NC} C(I) * E^{I-1} \quad E \text{ in MeV}$$

b) Tabular data form of NU array

<u>Location in XSS</u>	<u>Parameter</u>	<u>Description</u>
KNU	LNU=2	Tabular data flag
KNU+1	NR	Number of interpolation regions
KNU+2	NBT(I),I=1,NR	ENDF interpolation parameters
KNU+2+NR	INT(I),I=1,NR	If NR=0, NBT and INT are omitted and linear-linear interpolation is used.
KNU+2+2*NR	NE	Number of energies
KNU+3+2*NR	E(I),I=1,NE	Tabular energy points
KNU+3+2*NR+NE	$\bar{v}$ (I),I=1,NE	Corresponding values of $\bar{v}$

If delayed  $\bar{v}$  data exist, the precursor distribution format is given below. The energy distribution for delayed fission neutrons is given by data that follows the format in TABLE F-13 and TABLE F-14, where LED=JXS(26) and LDIS=JXS(27).

JXS(25)	DEC <sub>1</sub>	Decay constant for this group
JXS(25)+1	NR	Number of interpolation regions
JXS(25)+2	NBT(I),I=1,NR	ENDF interpolation parameters



## DATA BLOCKS FOR CONTINUOUS/DISCRETE NEUTRON TRANSPORT TABLES

TABLE F-5

## NU Block

JXS(25)+2+NR	INT(I),I=1, NR	If NR=0, NBT and INT are omitted and linear-linear interpolation is used.
JXS(25)+2+2*NR	NE	Number of energies
JXS(25)+3+2*NR	E(I),I=1,NE	Tabular energy points
JXS(25)+3+2*NR+NE	P(I),I=1,NE	Corresponding probabilities
JXS(25)+3+2*NR+2NE	DEC <sub>2</sub>	Decay constant for this group
.	.	.
.	.	.

TABLE F-6

## MTR, MTRP Blocks

<u>Location in XSS</u>	<u>Parameter</u>	<u>Description</u>
LMT	MT <sub>1</sub>	First ENDF reaction available
LMT+1	MT <sub>2</sub>	Second ENDF reaction available
.	.	.
.	.	.
.	.	.
LMT+NMT-1	MT <sub>NMT</sub>	Last ENDF reaction available

where LMT=JXS(3) for MTR Block  
 LMT=JXS(13) for MTRP Block  
 NMT=NXS(4) for MTR Block  
 NMT=NXS(6) for MTRP Block

**Note:** For MTR Block: MT<sub>1</sub>, MT<sub>2</sub>, ... are standard ENDF MT numbers, that is, MT=16=(n,2n); MT=17=(n,3n); etc.

For MTRP Block: the MT values are somewhat arbitrary. To understand the scheme used for numbering the photon production MTs, it is necessary to realize that in ENDF/B format, more than one photon can be produced by a particular neutron reaction that is itself specified by a single MT. Each of these photons is produced with an individual energy-dependent cross section. For example, MT 102 (radiative capture) might be responsible for 40 photons, each with its own cross section, angular distribution, and energy distribution. We need 40 photon MTs to represent the data; the MTs are numbered 102001, 102002, ... , 102040. Therefore, if ENDF/B MT "N" is responsible for "M" photons, we shall number the photon MTs 1000\*N+1, 1000\*N+2, ... , 1000\*N+M.

**APPENDIX F  
DATA BLOCKS FOR CONTINUOUS/DISCRETE NEUTRON TRANSPORT TABLES**

**TABLE F-7  
LQR Block**

<u>Location in XSS</u>	<u>Parameter</u>	<u>Description</u>
JXS(4)	$Q_1$	Q-value of reaction $MT_1$
JXS(4)+1	$Q_2$	Q-value of reaction $MT_2$
.	.	.
.	.	.
.	.	.
JXS(4)+NXS(4)-1	$Q_{NXS(4)}$	Q-value of reaction $MT_{NXS(4)}$

**Note:** The  $MT_i$ 's are given in the MTR Block.

**TABLE F-8  
TYR Block**

<u>Location in XSS</u>	<u>Parameter</u>	<u>Description</u>
JXS(5)	$TY_1$	Neutron release for reaction $MT_1$
JXS(5)+1	$TY_2$	Neutron release for reaction $MT_2$
.	.	.
.	.	.
.	.	.
JXS(5)+NXS(4)-1	$TY_{NXS(4)}$	Neutron release for reaction $MT_{NXS(4)}$

**Note:** The possible values of  $TY_i$  are  $\pm 1, \pm 2, \pm 3, \pm 4, 19, 0$  and integers greater than 100 in absolute value. The sign indicates the system for scattering: negative = CM system; positive = LAB system. Thus if  $TY_i = +3$ , three neutrons are released for reaction  $MT_i$ , and the data on the cross-section tables used to determine the exiting neutrons' angles are given in the LAB system.  
 $TY_i = 19$  indicates fission. The number of secondary neutrons released is determined from the fission  $\bar{\nu}$  data found in the NU Block.  
 $TY_i = 0$  indicates absorption (ENDF reactions  $MT > 100$ ); no neutrons are released.  
 $|TY_i| > 100$  signifies reactions other than fission that have energy-dependent neutron multiplicities. The number of secondary neutrons released is determined from the yield data found in the DLW Block. The  $MT_i$ 's are given in the MTR Block.

## DATA BLOCKS FOR CONTINUOUS/DISCRETE NEUTRON TRANSPORT TABLES

**TABLE F-9**  
**LSIG, LSIGP Blocks**

<u>Location in XSS</u>	<u>Parameter</u>	<u>Description</u>
LXS	$\text{LOCA}_1=1$	Loc. of cross sections for reaction $\text{MT}_1$
LXS+1	$\text{LOCA}_2$	Loc. of cross sections for reaction $\text{MT}_2$
.	.	.
.	.	.
.	.	.
LXS+NMT-1	$\text{LOCA}_{\text{NMT}}$	Loc. of cross sections for reaction $\text{MT}_{\text{NMT}}$

where LXS=JXS(6) for LSIG Block  
 LXS=JXS(14) for LSIGP Block  
 NMT=NXS(4) for LSIG Block  
 NMT=NXS(6) for LSIGP Block

**Note:** All locators are relative to JXS(7) for LSIG or JXS(15) for LSIGP. The  $\text{MT}_i$ 's are given in the MTR Block for LSIG or the MTRP Block for LSIGP.  $\text{LOCA}-i$  values must be monotonically increasing or data will be overwritten in subroutine EXPUNG.

**TABLE F-10**  
**SIG Block**

<u>Location in XSS</u>	<u>Description</u>
JXS(7)+ $\text{LOCA}_1-1$	Cross-section array* for reaction $\text{MT}_1$
JXS(7)+ $\text{LOCA}_2-1$	Cross-section array* for reaction $\text{MT}_2$
.	.
.	.
.	.
JXS(7)+ $\text{LOCA}_{\text{NXS}(4)}-1$	Cross-section array* for reaction $\text{MT}_{\text{NXS}(4)}$

\*The  $i^{\text{th}}$  array has the form:

<u>Location in XSS</u>	<u>Parameter</u>	<u>Description</u>
JXS(7)+ $\text{LOCA}_i-1$	$\text{IE}_i$	Energy grid index for reaction $\text{MT}_i$
JXS(7)+ $\text{LOCA}_i$	$\text{NE}_i$	Number of consecutive entries for $\text{MT}_i$
JXS(7)+ $\text{LOCA}_i+1$	$\sigma_i[\text{E}(\text{K})], \text{K}=\text{IE}_i, \text{IE}_i+\text{NE}_i-1$	Cross sections for reaction $\text{MT}_i$

**Note:** The values of  $\text{LOCA}_i$  are given in the LSIG Block. The energy grid  $\text{E}(\text{K})$  is given in the ESZ Block. The energy grid index  $\text{IE}_i$  corresponds to the first energy in the grid at which a cross section is given. The  $\text{MT}_i$ 's are defined in the MTR Block.

**APPENDIX F  
DATA BLOCKS FOR CONTINUOUS/DISCRETE NEUTRON TRANSPORT TABLES**

**TABLE F-11  
LAND Block**

<u>Location in XSS</u>	<u>Parameter</u>	<u>Description</u>
JXS(8)	LOCB <sub>1</sub> =1	Loc. of angular dist. data for: elastic scattering
JXS(8)+1	LOCB <sub>2</sub>	reaction MT <sub>1</sub>
.	.	.
.	.	.
JXS(8)+NXS(5)	LOCB <sub>NXS(5)+1</sub>	reaction MT <sub>NXS(5)</sub>

**Note:** All locators (LOCB<sub>*i*</sub>) are relative to JXS(9). If LOCB<sub>*i*</sub>=0, no angular distribution data are given for this reaction, and isotropic scattering is assumed in either the LAB or CM system. Choice of LAB or CM system depends upon value for this reaction in the TYR Block. The MT<sub>*i*</sub>'s are given in the MTR Block.  
If LOCB<sub>*i*</sub> = -1, no angular distribution data are given for this reaction in the AND Block. Angular distribution data are specified through LAW<sub>*i*</sub>=44 in the DLW Block.  
The LOCB<sub>*i*</sub> locators must be monotonically increasing or data will be overwritten in subroutine EXPUNG.

**TABLE F-12  
AND Block**

<u>Location in XSS</u>	<u>Description</u>
JXS(9)+LOCB <sub>1</sub> -1	Angular distribution array* for elastic scattering
JXS(9)+LOCB <sub>2</sub> -1	Angular distribution array* for reaction MT <sub>1</sub>
.	.
.	.
JXS(9)+LOCB <sub>NXS(5)+1</sub> -1	Angular distribution array* for reaction MT <sub>NXS(5)</sub>

**Note:** The values of LOCB<sub>*i*</sub> are given in the LAND Block. If LOCB<sub>*i*</sub> = 0, no angular distribution array is given and scattering is isotropic in either the LAB or CM system. Choice of LAB or CM system depends on value in the TYR Block. The MT<sub>*i*</sub>'s are given in the MTR Block.

\*The *i*<sup>th</sup> array has the form:

<u>Location in XSS</u>	<u>Parameter</u>	<u>Description</u>
JXS(9)+LOCB <sub><i>i</i></sub> -1	NE	Number of energies at which angular distributions are tabulated.
JXS(9)+LOCB <sub><i>i</i></sub>	E(J),J=1,NE	Energy grid
JXS(9)+LOCB <sub><i>i</i></sub> +NE	LC(J),J=1,NE	Location of tables* associated with energies E(J)

DATA BLOCKS FOR CONTINUOUS/DISCRETE NEUTRON TRANSPORT TABLES

If LC(J) is positive, it points to 32 equiprobable bin distribution.

If LC(J) is negative, it points to a tabular angular distribution.

If LC(J)=0=isotropic and no further information is needed.

\*The J<sup>th</sup> array for a 32 equiprobable bin distribution has the form:

JXS(9)+|LC(J)|-1      P(1,K),K=1,33      32 equiprobable cosine bins for scattering at energy E(1)

\*The J<sup>th</sup> array for a tabular angular distribution has the form:

JXS(9)+|LC(J)|-1 is now defined to be:

LDAT(K+1)	JJ	Interpolation flag: 0=histogram 1=lin-lin
LDAT(K+2)	NP	Number of points in the distribution
LDAT(K+3)	CSOUT(I),I=1,NP	Cosine scattering angular grid
LDAT(K+3+NP)	PDF(I),I=1,NP	Probability density function
LDAT(K+3+2*NP)	CDF(I),I=1,NP	Cumulative density function

**Note:** All values of LC(J) are relative to JXS(9). If LC(J) = 0, no table is given for energy E(J) and scattering is isotropic in the coordinate system indicated by entry in the TYR Block

**TABLE F-13**  
**LDLW, LDLWP Block**

<u>Location in XSS</u>	<u>Parameter</u>	<u>Description</u>
LED	LOCC <sub>1</sub>	Loc. of energy distribution data for reaction MT <sub>1</sub> or group 1 if delayed neutron
LED+1	LOCC <sub>2</sub>	Loc. of energy distribution data for reaction MT <sub>2</sub> or group 2 if delayed neutron
·	·	·
·	·	·
LED+NMT-1	LOCC <sub>NMT</sub>	Loc. of energy distribution data for reaction MT <sub>NMT</sub> or group NMT if delayed neutron
where LED=JXS(10) for LDLW Block		NMT=NXS(5) for LDLW Block
LED=JXS(18) for LDLWP Block		NMT=NXS(6) for LDLWP Block
LED=JXS(26) for delayed neutron		NMT=NXS(8) for delayed neutrons

**Note:** All locators are relative to JXS(11) for LDLW or JXS(19) for LDLWP. The MT<sub>i</sub>'s are given in the MTR Block for LDLW or MTRP Block for LDLWP. The LOCC<sub>i</sub> locators must be monotonically increasing or data will be overwritten in subroutine EXPUNG. For delayed neutrons, the LOCC<sub>i</sub> values are relative to JXS(27).

**APPENDIX F**  
**DATA BLOCKS FOR CONTINUOUS/DISCRETE NEUTRON TRANSPORT TABLES**

**TABLE F-14**  
**DLW, DLWP Block**

<u>Location in XSS</u>	<u>Description</u>
JED+LOCC <sub>1</sub> -1	Energy distribution array* for reaction MT <sub>1</sub>
JED+LOCC <sub>2</sub> -1	Energy distribution array* for reaction MT <sub>2</sub>
.	.
.	.
.	.
JED+LOCC <sub>NMT</sub> -1	Energy distribution array* for reaction MT <sub>NMT</sub>

where JED=JXS(11) for DLW  
 JED=JXS(19) for DLWP  
 NMT=NXS(5) for DLW  
 NMT=NXS(6) for DLWP

**Note:** Values of LOCC<sub>i</sub> are given in the LDLW and LDLWP Blocks. Values of MT<sub>i</sub> are given in the MTR and MTRP Blocks.

\*The i<sup>th</sup> array has the form:

<u>Location in XSS</u>	<u>Parameter</u>	<u>Description</u>
LDIS+LOCC <sub>i</sub> -1	LNW <sub>1</sub>	Location of next law. If LNW <sub>i</sub> =0, then law LAW <sub>1</sub> is used regardless of other circumstances.
LDIS+LOCC <sub>i</sub>	LAW <sub>1</sub>	Name of this law
LDIS+LOCC <sub>i</sub> +1	IDAT <sub>1</sub>	Location of data for this law relative to LDIS
LDIS+LOCC <sub>i</sub> +2	NR	Number of interpolation regions to define law applicability regime
LDIS+LOCC <sub>i</sub> +3	NBT(I),I=1,NR	ENDF interpolation parameters.
LDIS+LOCC <sub>i</sub> +3+NR	INT(I),I=1,NR	If NR=0, NBT and INT are omitted and linear-linear interpolation is used.
LDIS+LOCC <sub>i</sub> +3+2*NR	NE	Number of energies
LDIS+LOCC <sub>i</sub> +4+2*NR	E(I),I=NE	Tabular energy points
LDIS+LOCC <sub>i</sub> +4+2*NR+NE	P(I),I=1,NE	Probability of law validity. If the particle energy E is E<E(1), then P(E)=P(1). If E>E(NE), then P(E)=P(NE). If more than 1 law is given, then LAW <sub>1</sub> is used only if ξ < P(E) where ξ is a random number between 0 and 1.

DATA BLOCKS FOR CONTINUOUS/DISCRETE NEUTRON TRANSPORT TABLES

LDIS+IDAT <sub>1-1</sub>	LDAT(I),I=1,L**	Law data array for LAW <sub>1</sub> . The length L of the law data array LDAT is determined from parameters within LDAT. The various law data arrays LDAT for each law LAW <sub>i</sub> are given in the following tables.
LDIS+LNW <sub>1-1</sub>	LNW <sub>2</sub>	Location of next law
LDIS+LNW <sub>1</sub>	LAW <sub>2</sub>	Name of this law
LDIS+LNW <sub>1+1</sub>	IDAT <sub>2</sub>	Location of data for this law
.	.	.
.	.	.
.	.	.

where LDIS=JXS(11) for DLW  
 LDIS=JXS(19) for DLWP  
 LDIS=JXS(27) for delayed neutrons

**Note:** The locators LOCC<sub>i</sub> are defined in the LDLW Block or the LDLWP Block. All locators (LNW<sub>i</sub>, IDAT<sub>i</sub>) are relative to LDIS.

\*\*We now define the format of the LDAT array for each law. Laws 2 and 4 are used to describe the spectra of secondary photons from neutron collisions. All laws except for Law 2 are used to describe the spectra of scattered neutrons. In the following tables we provide relative locations of data in the LDAT array rather than absolute locations in the XSS array. The preceding table defines the starting location of the LDAT array within the XSS array.

a. LAW<sub>i</sub>=1 Tabular Equiprobable Energy Bins (From ENDF Law 1)

<u>Location</u>	<u>Parameter</u>	<u>Description</u>
LDAT(1)	NR	Interpolation scheme between tables of E <sub>out</sub> . If NR=0 or if INT(I) ±1 (histogram), linear-linear interpolation is used
LDAT(2)	NBT(I),I=1,NR	
LDAT(2+NR)	INT(I),I=1,NR	
LDAT(2+2*NR)	NE	Number of incident energies tabulated
LDAT(3+2*NR)	E <sub>in</sub> (I),I=1,NE	List of incident energies for which E <sub>out</sub> is tabulated
LDAT(3+2*NR+NE)	NET	Number of outgoing energies in each E <sub>out</sub> table
LDAT(4+2*NR+NE)	E <sub>out1</sub> (I),I=1,NET	E <sub>out</sub> tables are NET boundaries of NET-1 equally likely energy intervals. Linear-linear interpolation is used between intervals
	E <sub>out2</sub> (I),I=1,NET	
	E <sub>outNE</sub> (I),I=1,NET	

**APPENDIX F**  
**DATA BLOCKS FOR CONTINUOUS/DISCRETE NEUTRON TRANSPORT TABLES**

b.  $LAW_i=2$  Discrete Photon Energy

<u>Location</u>	<u>Parameter</u>	<u>Description</u>
LDAT(1)	LP	Indicator of whether the photon is a primary or nonprimary photon
LDAT(2)	EG	Photon energy (if LP=0 or LP=1), or Binding energy (if LP=2)

If LP=0 or LP=1, the photon energy is EG

If LP=2, the photon energy is  $EG+(AWR)/(AWR+1)*EN$ , where AWR is the atomic weight ratio and EN is the neutron energy

c.  $LAW_i=3$  Level Scattering (From ENDF Law 3)

$$LDAT(1) = \left(\frac{A+1}{A}\right) |Q| \quad LDAT(2) = \left(\frac{A}{A+1}\right)^2$$

$$E_{out}^{CM} = LDAT(2) * (E - LDAT(1))$$

where  $E_{out}^{CM}$  = outgoing center-of-mass energy

E = incident energy

A = atomic weight ratio

Q = Q-value

The outgoing neutron energy in the laboratory system,  $E_{out}^{LAB}$ , is

$$E_{out}^{LAB} = E_{out}^{CM} + \left\{ E + 2\mu_{cm}(A+1)(EE_{out}^{CM})^{1/2} \right\} / (A+1)^2,$$

where  $\mu_{cm}$  = cosine of the center-of-mass scattering angle.

d.  $LAW_i=4$  Continuous Tabular Distribution (From ENDF Law 1)

<u>Location</u>	<u>Parameter</u>	<u>Description</u>
LDAT(1)	NR	Number of interpolation regions
LDAT(2)	NBT(I),I=1,NR	ENDF interpolation parameters. If NR=0, NBT and INT are omitted and linear-linear interpolation is used.
LDAT(2+NR)	INT(I),I=1,NR	
LDAT(2+2*NR)	NE	Number of energies at which distributions are tabulated
LDAT(3+2*NR)	E(I),I=1,NE	Incident neutron energies
LDAT(3+2*NR+NE)	L(I),I=1,NE	Locations of distributions (relative to JXS(11) or JXS(19))



DATA BLOCKS FOR CONTINUOUS/DISCRETE NEUTRON TRANSPORT TABLES

Data for E(1) (let  $K=3+2*NR+2*NE$ ):

LDAT(K)	INTT'	Combination of the number of discrete photon lines, ND, and the interpolation scheme for subsequent data, INTT=1 histogram distribution INTT=2 linear-linear distribution
LDAT(K+1)	NP	Number of points in the distribution
LDAT(K+2)	EOUT(I),I=1,NP	Outgoing energy grid
LDAT(K+2+NP)	PDF(I),I=1,NP	Probability density function
LDAT(K+2+2*NP)	CDF(I),I=1,NP	Cumulative density function

Data for E(2):

. . .

If the value of LDAT(K) is  $INTT' > 10$ , then

$$INTT' = (ND*10) + INTT$$

where INTT is the interpolation scheme and the first ND values of NP points describe discrete photon lines. The remaining NP - ND values describe a continuous distribution. In this way the distribution may be discrete, continuous, or a discrete distribution superimposed upon a continuous background.

e. LAW<sub>i</sub>=5 General Evaporation Spectrum (From ENDF Law 5)

<u>Location</u>	<u>Parameter</u>	<u>Description</u>
LDAT(1)	NR	Interpolation scheme between T's
LDAT(2)	NBT(I),I=1,NR	
LDAT(2+NR)	INT(I),I=1,NR	
LDAT(2+2*NR)	NE	Number of incident energies tabulated
LDAT(3+2*NR)	E(I),I=1,NE	Incident energy table
LDAT(3+2*NR+NE)	T(I),I=1,NE	Tabulated function of incident energies
LDAT(3+2*NR+2*NE)	NET	Number of X's tabulated
LDAT(4+2*NR+2*NE)	X(I),I=1,NET	Tabulated probabilistic function

$E_{out} = X(\xi)*T(E)$ , where X( $\xi$ ) is a randomly sampled table of X's, and E is the incident energy.

f. LAW<sub>i</sub>=7 Simple Maxwell Fission Spectrum (From ENDF Law 7)

<u>Location</u>	<u>Parameter</u>	<u>Description</u>
LDAT(1)	NR	Interpolation scheme between T's
LDAT(2)	NBT(I),I=1,NR	
LDAT(2+NR)	INT(I),I=1,NR	
LDAT(2+2*NR)	NE	Number of incident energies tabulated

## APPENDIX F

### DATA BLOCKS FOR CONTINUOUS/DISCRETE NEUTRON TRANSPORT TABLES

LDAT(3+2*NR)	E(I),I=1,NE	Incident energy table
LDAT(3+2*NR+NE)	T(I),I=1,NE	Tabulated T's
LDAT(3+2*NR+2*NE)	U	Restriction energy

$$f(E \rightarrow E_{out}) = C \sqrt{E_{out}} e^{-E_{out}/T(E)}$$

with restriction  $0 \leq E_{out} \leq E - U$

$$C = T^{-3/2} \left[ \frac{\sqrt{\pi}}{2} \operatorname{erf}(\sqrt{(E-U)/T}) + \sqrt{(E-U)/T} e^{-(E-U)/T} \right]^{-1}$$

g. LAW<sub>i</sub>=9 Evaporation Spectrum (From ENDF Law 9)

<u>Location</u>	<u>Parameter</u>	<u>Description</u>
LDAT(1)	NR	Interpolation scheme between T's
LDAT(2)	NBT(I),I=1,NR	
LDAT(2+NR)	INT(I),I=1,NR	
LDAT(2+2*NR)	NE	Number of incident energies tabulated
LDAT(3+2*NR)	E(I),I=1,NE	Incident energy table
LDAT(3+2*NR+NE)	T(I),I=1,NE	Tabulated T's
LDAT(3+2*NR+2*NE)	U	Restriction energy

$$f(E \rightarrow E_{out}) = C E_{out} e^{-E_{out}/T(E)}$$

with restriction  $0 \leq E_{out} \leq E - U$

$$C = T^{-2} \left[ 1 - e^{(E-U)/T} (1 + (E-U)/T) \right]^{-1}$$

h. LAW<sub>i</sub>=11 Energy Dependent Watt Spectrum (From ENDF Law 11)

<u>Location</u>	<u>Parameter</u>	<u>Description</u>
LDAT(1)	NR <sub>a</sub>	Interpolation scheme between a's
LDAT(2)	NBT <sub>a</sub> (I),I=1,NR <sub>a</sub>	
LDAT(2+NR <sub>a</sub> )	INT <sub>a</sub> (I),I=1,NR <sub>a</sub>	
LDAT(2+2*NR <sub>a</sub> )	NE <sub>a</sub>	Number of incident energies tabulated for a(E <sub>in</sub> ) table
LDAT(3+2*NR <sub>a</sub> )	E <sub>a</sub> (I),I=1,NE <sub>a</sub>	Incident energy table
LDAT(3+2*NR <sub>a</sub> +NE <sub>a</sub> )	a(I),I=1,NE <sub>a</sub>	Tabulated a's
let L=3+2*(NR <sub>a</sub> +NE <sub>a</sub> )		

DATA BLOCKS FOR CONTINUOUS/DISCRETE NEUTRON TRANSPORT TABLES

LDAT(L)	$NR_b$	} Interpolation scheme between $b$ 's
LDAT(L+1)	$NBT_b(I), I=1, NR_b$	
LDAT(L+1+ $NR_b$ )	$INT_b(I), I=1, NR_b$	
LDAT(L+1+2* $NR_b$ )	$NE_b$	
		Number of incident energies tabulated for $b(E_{in})$ table
LDAT(L+2+2* $NR_b$ )	$E_b(I), I=1, NE_b$	Incident energy table
LDAT(L+2+2* $NR_b+NE_b$ )	$b(I), I=1, NE_b$	Tabulated $b$ 's
LDAT(L+2+2* $NR_b+2*NE_b$ )	U	Rejection energy

$$f(E \rightarrow E_{out}) = C_o \exp[-E_{out}/a(E)] \sinh[b(E)E_{out}]^{1/2}$$

with restriction  $0 \leq E_{out} < E - U$

This law is sampled by the rejection scheme in LA-5061-MS (R11, pg. 45).

i. LAW<sub>i</sub>=22 Tabular Linear Functions (from UK Law 2)

<u>Location in XSS</u>	<u>Parameter</u>	<u>Description</u>
LDAT(1)	NR	} Interpolation parameters that are not used by MCNP (histogram interpolation is assumed)
LDAT(2)	$NBT(I), I=1, NR$	
LDAT(2+NR)	$INT(I), I=1, NR$	
LDAT(2+2*NR)	NE	} Number of incident energies tabulated
LDAT(3+2*NR)	$E_{in}(I), I=1, NE$	
LDAT(3+2*NR+NE)	$LOCE(I), I=1, NE$	List of incident energies for $E_{out}$ tables
Data for $E_{in}(1)$ (Let $L=3+2*NR+2*NE$ ):		Locators of $E_{out}$ tables (relative to JXS(11))
LDAT(L)	$NF_1$	} if $E_{in}(I)_i < E < E_{in}(I+1)$ and $\xi$ is a random number [0,1] then if $\sum_{k=1}^{k=K} P_I(K) < \xi \leq \sum_{k=1}^{k=K} P_I(K)$
LDAT(L+1)	$P_1(K), K=1, NF_1$	
LDAT(L+1+ $NF_1$ )	$T_1(K), K=1, NF_1$	
LDAT(L+1+2* $NF_1$ )	$C_1(K), K=1, NF_1$	
Data for $E_{in}(2)$ :		$E_{out} = C_I(K)*(E-T_I(K))$

j. LAW<sub>i</sub>=24 (From UK Law 6)

<u>Location in XSS</u>	<u>Parameter</u>	<u>Description</u>
LDAT(1)	NR	} Interpolation parameters that are not used by MCNP (histogram interpolation is assumed)
LDAT(2)	$NBT(I), I=1, NR$	
LDAT(2+NR)	$INT(I), I=1, NR$	
LDAT(2+2*NR)	NE	Number of incident energies
LDAT(3+2*NR)	$E_{in}(I), I=1, NE$	List of incident energies for which T is tabulated
LDAT(3+2*NR+NE)	NET	Number of outgoing values in each table

**APPENDIX F**  
**DATA BLOCKS FOR CONTINUOUS/DISCRETE NEUTRON TRANSPORT TABLES**

LDAT(4+2\*NR+NE)       $T_1(I), I=1, \text{NET}$   
                                   $T_2(I), I=1, \text{NET}$   
                                  .  
                                  .  
                                   $T_{NE}(I), I=1, \text{NET}$

Tables are NET boundaries  
of NET-1 equally likely  
intervals. Linear-linear  
interpolation is used between  
intervals.

$E_{out} = T_K(I) * E$   
where  $T_K(I)$  is sampled from the above tables  
E is the incident neutron energy

k. LAW<sub>i</sub>=44    Kalbach-87 Formalism    (From ENDF File 6 Law 1,    LANG=2)

<u>Location</u>	<u>Parameter</u>	<u>Description</u>
LDAT(1)	NR	Number of interpolation regions
LDAT(2)	NBT(I), I=1, NR	ENDF interpolation parameters. If NR=0, NBT and INT are omitted and linear-linear interpolation is used.
LDAT(2+NR)	INT(I), I=1, NR	
LDAT(2+2*NR)	NE	Number of energies at which distributions are tabulated
LDAT(3+2*NR)	E(I), I=1, NE	Incident neutron energies
LDAT(3+2*NR+NE)	L(I), I=1, NE	Locations of distributions (relative to JXS(11) or JXS(19))
Data for E(1) (let K=3+2*NR+2*NE):		
LDAT(K)	INTT'	Interpolation scheme for subsequent data INTT=1 histogram distribution INTT=2 linear-linear distribution
LDAT(K+1)	NP	Number of points in the distribution
LDAT(K+2)	EOUT(I), I=1, NP	Outgoing energy grid
LDAT(K+2+NP)	PDF(I), I=1, NP	Probability density function
LDAT(K+2+2*NP)	CDF(I), I=1, NP	Cumulative density function
LDAT(K+2+3*NP)	R(I), I=1, NP	Precompound fraction r
LDAT(K+2+4*NP)	A(I), I=1, NP	Angular distribution slope value a
Data for E(2):		
.	.	.
.	.	.

If the value of LDAT(K) is  $INTT' > 10$ , then  
 $INTT' = 10 * ND + INTT$

where INTT is the interpolation scheme and the first ND values of NP describe discrete photon lines. The remaining NP - ND values describe a continuous distribution. In this way the distribution may be discrete, continuous, or a discrete distribution superimposed upon a continuous background.

DATA BLOCKS FOR CONTINUOUS/DISCRETE NEUTRON TRANSPORT TABLES

The angular distributions for neutrons are then sampled from

$$p(\mu, E_{in}, E_{out}) = \frac{1}{2} \frac{A}{\sinh(A)} [\cosh(A\mu) + R \sinh(A\mu)]$$

as described in Chapter 2.

1. LAW<sub>i</sub>=61 Like LAW 44 but tabular angular distribution instead of Kalbach-87

<u>Location</u>	<u>Parameter</u>	<u>Description</u>
LDAT(1)	NR	Number of interpolation regions
LDAT(2)	NBT(I), I=1, NR	ENDF interpolation parameters. If NR=0, NBT and INT are omitted and linear-linear interpolation is used.
LDAT(2+NR)	INT(I), I=1, NR	
LDAT(2+2*NR)	NE	Number of energies at which distributions are tabulated
LDAT(3+2*NR)	E(I), I=1, NE	Incident neutron energies
LDAT(3+2*NR+NE)	L(I), I=1, NE	Locations of distributions (relative to JXS(11) or JXS(19))
Data for E(1) (let K=3+2*NR+2*NE):		
LDAT(K)	INTT'	Interpolation scheme for subsequent data INTT=1 histogram distribution INTT=2 linear-linear distribution
LDAT(K+1)	NP	Number of points in the distribution
LDAT(K+2)	EOUT(I), I=1, NP	Outgoing energy grid
LDAT(K+2+NP)	PDF(I), I=1, NP	Probability density function
LDAT(K+2+2*NP)	CDF(I), I=1, NP	Cumulative density function
LDAT(K+2+3*NP)	LC(I), I=1, NP	Location of tables* associated with energies E(I) If LC(I) is positive, it points to a tabular angular distribution. If LC(I)=0=isotropic and no further information is needed. 32 equiprobable bin distribution is not allowed.
*The J <sup>th</sup> array for a tabular angular distribution has the form:: JXS(11) or JXS(19)+ LC(J) -1 is now defined to be:		
LDAT(L+1)	JJ	Interpolation flag: 0=histogram 1=lin-lin
LDAT(L+2)	NP	Number of points in the distribution
LDAT(L+3)	CSOUT(I), I=1, NP	Cosine scattering angular grid
LDAT(L+3+NP)	PDF(I), I=1, NP	Probability density function
LDAT(L+3+2*NP)	CDF(I), I=1, NP	Cumulative density function

Data for E(2):

**APPENDIX F**  
**DATA BLOCKS FOR CONTINUOUS/DISCRETE NEUTRON TRANSPORT TABLES**

If the value of LDAT(K) is  $INTT' > 10$ , then  
 $INTT' = 10 * ND + INTT$

m. LAW<sub>i</sub>=66    N-body phase space distribution    (From ENDF File 6 Law 6)

<u>Location</u>	<u>Parameter</u>	<u>Description</u>
LDAT(1)	NPSX	Number of bodies in the phase space
LDAT(2)	A <sub>p</sub>	Total mass ratio for the NPSX particles

$$E_{out} = T(\xi) * E_i^{max}$$

where

$$E_i^{max} = \frac{A_p - 1}{A_p} \left( \frac{A}{A + 1} E_{in} + Q \right)$$

and  $T(\xi)$  is sampled from

$$P_i(\mu, E_{in}, T) = C_n \sqrt{T} (E_i^{max} - T)^{3n/2 - 4}$$

where the sampling scheme is from R28 of LA-9721-MS and is described in Chapter 2, page 2–50.

n. LAW<sub>i</sub>=67    Laboratory Angle–Energy Law    (From ENDF File 6 Law 7)

<u>Location</u>	<u>Parameter</u>	<u>Description</u>
LDAT(1)	NR	Number of interpolation regions
LDAT(2)	NBT(I), I=1, NR	ENDF interpolation parameters. If NR=0, NBT and INT are omitted and linear-linear interpolation is used.
LDAT(2+NR)	INT(I), I=1, NR	
LDAT(2+2*NR)	NE	Number of energies at which distributions are tabulated
LDAT(3+2*NR)	E(I), I=1, NE	Incident neutron energies
LDAT(3+2*NR+NE)	L(I), I=1, NE	Locations of distributions (relative to JXS(11) or JXS(19))
Data for E(1) (let K=3+2*NR+2*NE):		
LDAT(K)	INTMU	Interpolation scheme for secondary cosines INTMU=1 histogram distribution INTMU=2 linear-linear distribution
LDAT(K+1)	NMU	Number of secondary cosines
LDAT(K+2)	XMU(I), I=1, NMU	Secondary cosines

## DATA BLOCKS FOR CONTINUOUS/DISCRETE NEUTRON TRANSPORT TABLES

LDAT(K+2+NMU)	LMU(I),I=1,NMU)	Location of data for each secondary cosine (relative to JXS(11) or JXS(19))
Data for XMU(1) (let J=K+2+2*NMU):		
LDAT(J)	INTEP	Interpolation parameter between secondary energies (INTEP=1 is histogram, INTEP=2 is linear-linear)
LDAT(J+1)	NPEP	Number of secondary energies
LDAT(J+2)	EP(I),I=1,NPEP	Secondary energy grid
LDAT(J+2+NPEP)	PDF(I),I=1,NPEP	Probability density function
LDAT(J+2+2*NPEP)	CDF(I),I=1,NPEP	Cumulative density function
Data for XMU(2)		
.		
.		
Data for XMU(NMU)		
.		
.		
Data for E(2)		
.		
.		
Data for E(NE)		
.		
.		

## o. Energy-Dependent Neutron Yields

There are additional numbers to be found for neutrons in the DLW array. For those reactions with entries in the TYR block that are greater than 100 in absolute value, there must be neutron yields  $Y(E)$  provided as a function of neutron energy. The neutron yields are handled similar to the average number of neutrons per fission  $\bar{\nu}(E)$  that is given for the fission reactions. These yields are a part of the coupled energy-angle distributions given in File 6 of ENDF-6 data.

Location in XSS

JED + |TY<sub>i</sub>| - 101      Neutron yield data for reaction MT<sub>i</sub>

where JED=JXS(11)=DLW

$i \leq$  number of reactions with negative angular distributions locators

The *i*th array has the form

**APPENDIX F  
DATA BLOCKS FOR CONTINUOUS/DISCRETE NEUTRON TRANSPORT TABLES**

<u>Location in XSS</u>	<u>Parameter</u>	<u>Description</u>
KY	NR	Number of interpolation regions
KY+1	NBT(I),I=1,NR	ENDF interpolation parameters. If NR=0
KY+1+NR	INT(I),I=1,NR	NBT and INT are omitted and linear-linear interpolation is used.
KY+1+2*NR	NE	Number of energies
KY+2+2*NR	E(I),I=1,NE	Tabular energy points
KY+2+2*NR+NE	Y(I),I=1,NE	Corresponding Y(E) values

where KY=JED+|TY<sub>i</sub>|-101

**TABLE F-15  
GPD Block**

<u>Location in XSS</u>	<u>Parameter</u>	<u>Description</u>
JXS(12)	$\sigma_{\gamma}(I), I=1, NXS(3)$	Total photon production cross section
JXS(12)+NXS(3)	EG(1,K),K=1,20	20 equally likely outgoing photon energies for incident neutron energy $E < EN(2)$
JXS(12)+NXS(3)+20	EG(2,K),K=1,20	20 equiprobable outgoing photon energies for incident neutron energy $EN(2) \leq E < EN(3)$
.	.	.
.	.	.
.	.	.
JXS(12)+NXS(3)+580	EG(30,K),K=1,20	20 equiprobable outgoing photon energies for incident neutron energy $E \geq EN(30)$

Notes: (1) The discrete incident neutron energy array in MeV is EN(J),J=1,30: 1.39E-10, 1.52E-7, 4.14E-7, 1.13E-6, 3.06E-6, 8.32E-6, 2.26E-5, 6.14E-5, 1.67E-4, 4.54E-4, 1.235E-3, 3.35E-3, 9.23E-3, 2.48E-2, 6.76E-2, .184, .303, .500, .823, 1.353, 1.738, 2.232, 2.865, 3.68, 6.07, 7.79, 10., 12., 13.5, 15.  
(2) The equiprobable photon energy matrix is used only for those older tables that do not provide expanded photon production data, and no currently-supported libraries use this data.



## DATA BLOCKS FOR CONTINUOUS/DISCRETE NEUTRON TRANSPORT TABLES

**TABLE F-16**  
**SIGP Block**

<u>Location in XSS</u>	<u>Description</u>
JXS(15)+LOCA <sub>1</sub> -1	Cross-section array* for reaction MT <sub>1</sub>
JXS(15)+LOCA <sub>2</sub> -1	Cross-section array* for reaction MT <sub>2</sub>
.	.
JXS(15)+LOCA <sub>NXS(6)</sub> -1	Cross-section array* for reaction MT <sub>NXS(6)</sub>

\*The i<sup>th</sup> array has three possible forms, depending on the first word in the array:

- (a) If MFTYPE=12 (Yield Data taken from ENDF File 12) or  
If MFTYPE=16 (Yield Data taken from ENDF File 6)

<u>Location in XSS</u>	<u>Parameter</u>	<u>Description</u>
JXS(15)+LOCA <sub>i</sub> -1	MFTYPE	12 or 16
JXS(15)+LOCA <sub>i</sub>	MTMULT	Neutron MT whose cross section should multiply the yield
JXS(15)+LOCA <sub>i</sub> +1	NR	Number of interpolation regions
JXS(15)+LOCA <sub>i</sub> +2	NBT(I),I=1, NR	ENDF interpolation parameters. If NR=0, NBT and INT are omitted and linear-linear interpolation is used.
JXS(15)+LOCA <sub>i</sub> +2+NR	INT(I),I=1, NR	Number of energies at which the yield is tabulated
JXS(15)+LOCA <sub>i</sub> +2+2*NR	NE	Energies
JXS(15)+LOCA <sub>i</sub> +3+2*NR	E(I),I=1, NE	Yields
JXS(15)+LOCA <sub>i</sub> +3 +2*NR+NE	Y(I),I=1, NE	

$$\sigma_{\gamma, i} = Y(E) * \sigma_{MTMULT}(E)$$

- (b) If MFTYPE=13 (Cross-Section Data from ENDF File 13)

<u>Location in XSS</u>	<u>Parameter</u>	<u>Description</u>
JXS(15)+LOCA <sub>i</sub> -1	MFTYPE	13
JXS(15)+LOCA <sub>i</sub>	IE	Energy grid index
JXS(15)+LOCA <sub>i</sub> +1	NE	Number of consecutive entries
JXS(15)+LOCA <sub>i</sub> +2	$\sigma_{\gamma, i}[E(K)], K = IE, IE + NE - 1$	Cross sections for reaction MT <sub>i</sub>

Note: The values of LOCA<sub>i</sub> are given in the LSIGP Block. The energy grid E(K) is given in the ESZ Block. The MT<sub>i</sub>'s are defined in the MTRP Block.

**APPENDIX F**  
**DATA BLOCKS FOR CONTINUOUS/DISCRETE NEUTRON TRANSPORT TABLES**

**TABLE F-17**  
**LANDP Block**

<u>Location in XSS</u>	<u>Parameter</u>	<u>Description</u>
JXS(16)	LOCB <sub>1</sub> =1	Loc. of angular dist. data for reaction MT <sub>1</sub>
JXS(16)+1	LOCB <sub>2</sub>	Loc. of angular dist. data for reaction MT <sub>2</sub>
.	.	.
.	.	.
.	.	.
JXS(16)+NXS(6) - 1	LOCB <sub>NXS(6)</sub>	Loc. of angular dist. data for reaction MT <sub>NXS(6)</sub>

Note: All locators (LOCB<sub>i</sub>) are relative to JXS(17). If LOCB<sub>i</sub>=0, there are no angular distribution data given for this reaction and isotropic scattering is assumed in the LAB system. MT<sub>i</sub>'s are defined in the MTRP Block.

**TABLE F-18**  
**ANDP Block**

<u>Location in XSS</u>	<u>Description</u>
JXS(17)+LOCB <sub>1</sub> -1	Angular distribution array* for reaction MT <sub>1</sub>
JXS(17)+LOCB <sub>2</sub> -1	Angular distribution array* for reaction MT <sub>2</sub>
JXS(17)+LOCB <sub>NXS(6)</sub> -1	Angular distribution array* for reaction MT <sub>NXS(6)</sub>

Note: The values of LOCB<sub>i</sub> are given in the LANDP Block. If LOCB<sub>i</sub>=0, then no angular distribution array is given and scattering is isotropic in the LAB system. The MT<sub>i</sub>'s are given in the MTRP Block.

\*The i<sup>th</sup> array has the form:

<u>Location in XSS</u>	<u>Parameter</u>	<u>Description</u>
JXS(17)+LOCB <sub>i</sub> -1	NE	Number of energies at which angular distributions are tabulated.
JXS(17)+LOCB <sub>i</sub>	E(J),J=1,NE	Energy grid
JXS(17)+LOCB <sub>i</sub> +NE	LC(J),J=1,NE	Location of tables associated with energies E(J)
JXS(17)+LC(1)-1	P(1,K),K=1,33	32 equiprobable cosine bins for scattering at energy E(1)
JXS(17)+LC(2)-1	P(2,K),K=1,33	32 equiprobable cosine bins for scattering at energy E(2)
.	..	.
.	.	.
JXS(17)+LC(NE)-1	P(NE,K),K=1,33	32 equiprobable cosine bins for scattering at energy E(NE)

Note: All values of LC(J) are relative to JXS(17). If LC(J)=0, no table is given for energy E(J) and scattering is isotropic in the LAB system.

## DATA BLOCKS FOR CONTINUOUS/DISCRETE NEUTRON TRANSPORT TABLES

TABLE F-19

## YP Block

<u>Location in XSS</u>	<u>Parameter</u>	<u>Description</u>
JXS(20)	NYP	Number of neutron MTs to follow
JXS(20)+1	MTY(I),I=1,NYP	Neutron MTs

Note: The MTY array contains all neutron MTs that are required as photon-production yield multipliers (See TABLE F-16). MCNP needs this information when expunging data

TABLE F-20

## FIS Block

<u>Location in XSS</u>	<u>Parameter</u>	<u>Description</u>
JXS(21)	IE	Energy grid index
JXS(21)+1	NE	Number of consecutive entries
JXS(21)+2	$\sigma_f[E(K)], K=IE, IE+NE-1$	Total fission cross sections

Note: The FIS Block generally is not provided on individual data tables because the total fission cross section is a redundant quantity [that is,  $\sigma_{f,tot}(E) = \sigma_{n,f}(E) + \sigma_{n,n'f}(E) + \sigma_{n,2nf}(E) + \sigma_{n,3nf}(E)$ ]. MCNP forms the FIS Block if conditions warrant (for example, for KCODE calculations, coupled neutron/photon calculations, etc.). The energy grid E(K) is given in the ESZ Block.

TABLE F-21

## UNR Block

<u>Location in XSS</u>	<u>Parameter</u>	<u>Description</u>
JXS(23)	N	Number of incident energies where there is a probability table
JXS(23)+1	M	Length of table; i.e., number of probabilities, typically 20
JXS(23)+2	INT	Interpolation parameter between tables =2 lin-lin; =5 log-log
JXS(23)+3	ILF	Inelastic competition flag (see below)
JXS(23)+4	IOA	Other absorption flag (see below)
JXS(23)+5	IFF	Factors flag (see below)
JXS(23)+6	E(I),I=1,N	Incident energies
JXS(23)+6+N	P(I,J,K)	Probability tables (see below)

Note: ILF is the inelastic competition flag. If this flag is less than zero, the inelastic cross section is zero within the entire unresolved energy range. If this flag is more than zero, then its value is a special MT number whose tabulation is the sum of the inelastic levels. An exception to this scheme is typically made when there is only one inelastic level within the unresolved energy range, because the flag can then just be set to its MT number and the special tabulation is not needed. The flag can also be set to zero, which means that the sum of the contribution of the inelastic reactions will be made using a balance relationship involving the smooth cross sections.

## APPENDIX F

### DATA BLOCKS FOR DOSIMETRY TABLES

IOA is the other absorption flag for determining the contribution of “other absorptions” (no neutron out or destruction reactions). If this flag is less than zero, the “other absorption” cross section is zero within the entire unresolved energy range. If this flag is more than zero, then its value is a special MT number whose tabulation is the sum of the “other absorption” reactions. An exception to this scheme is typically made when there is only one “other absorption” reaction within the unresolved energy range, because the flag can then just be set to its MT number and the special tabulation is not needed. The flag can also be set to zero, which means that the sum of the contribution of the “other absorption” reactions will be made using a balance relationship involving the smooth cross sections.

IFF is the factors flag. If this flag is zero, then the tabulations in the probability tables are cross sections. If the flag is one, the tabulations in the probability tables are factors that must be multiplied by the corresponding “smooth” cross sections to obtain the actual cross sections.

$P(I,J,K)$ , where  $I=1,N$ ,  $J=1,6$ , and  $K=1,M$ , are the tables at  $N$  incident energies for  $M$  cumulative probabilities. For each of these probabilities the  $J$  values are:

<u>J</u>	<u>Description</u>
1	cumulative probability
2	total cross section or total factor
3	elastic cross section or elastic factor
4	fission cross section or fission factor
5	$(n,\gamma)$ cross section or $(n,\gamma)$ factor
6	neutron heating number or heating factor

The ordering of the probability-table entries is as follows

- M cumulative probabilities for energy  $I=1$  ( $K=1$  through  $K=M$ )
- M total cross sections (or factors) for energy  $I=1$  ( $K=1$  through  $K=M$ )
- ...
- M cumulative probabilities for energy  $I=2$  ( $K=1$  through  $K=M$ )
- ...
- M neutron heating numbers (or factors) for energy  $I=N$  ( $K=1$  through  $K=M$ )

Notes: The cumulative probabilities are monotonically increasing from an implied lower value of zero to the upper value of  $P(I,1,K=M) = 1.0$ . The total cross section,  $P(I,2,J)$ , is not used in MCNP; the total is recalculated from sampled partials to avoid round-off error. The  $(n,\gamma)$  cross section is radiative capture only; it is not the usual MCNP “capture” cross section, which is really absorption or destruction with other no-neutron-out reactions.

## V. DATA BLOCKS FOR DOSIMETRY TABLES

Dosimetry tables (NTY=3) provide cross sections that are useful as response functions with the FM feature in MCNP. They can never be used for actual neutron transport. Therefore, there is a more limited set of information available on dosimetry tables than on neutron transport tables (NTY=1 or 2). Only three blocks of data exist on dosimetry tables. The three blocks follow, with the table numbers in which their formats are detailed.

**APPENDIX F**  
**DATA BLOCKS FOR THERMAL S( $\alpha,\beta$ ) TABLES**

1. MTR Block—contains a list of the MT numbers for all reactions provided on the table. The MTR Block always exists on dosimetry tables. The format of the block is identical to that of the MTR Block previously described for neutron transport tables. See TABLE F-6.
2. LSIG Block—contains a list of cross-section locators for all reactions provided on the table. The LSIG Block always exists on dosimetry tables. The format of the block is identical to that of the LSIG Block previously described for neutron transport tables. See TABLE F-9.
3. SIGD Block—contains (energy, cross-section) pairs for all reactions provided on the table. The SIGD Block always exists on dosimetry tables. See TABLE F-22.

**TABLE F-22**  
**SIGD Block**

<u>Location in XSS</u>	<u>Description</u>
JXS(7)+LOCA <sub>1</sub> -1	Cross-section array* for reaction MT <sub>1</sub>
JXS(7)+LOCA <sub>2</sub> -1	Cross-section array* for reaction MT <sub>2</sub>
⋮	⋮
JXS(7)+LOCA <sub>NXS(4)</sub> -1	Cross-section array* for reaction MT <sub>NXS(4)</sub>

\*The i<sup>th</sup> array is of the form:

<u>Location in XSS</u>	<u>Parameter</u>	<u>Description</u>
JXS(7)+LOCA <sub>i</sub> -1	NR	Number of interpolation regions
JXS(7)+LOCA <sub>i</sub>	NBT(I),I=1,NR	ENDF interpolation parameters. If NR=0,
JXS(7)+LOCA <sub>i</sub> +NR	INT(I),I=1,NR	NBT and INT are omitted and linear-linear interpolation is assumed.
JXS(7)+LOCA <sub>i</sub> +2*NR	NE	Number of (energy,cross section) pairs
JXS(7)+LOCA <sub>i</sub> +1 +2*NR	E(I),I=1,NE	Energies
JXS(7)+LOCA <sub>i</sub> +1+2*NR+NE	$\sigma$ (I),I=1,NE	Cross sections

Note: The locators (LOCA<sub>i</sub>) are provided in the LSIG Block. The MT<sub>i</sub>'s are given in the MTR Block.

## **VI. DATA BLOCKS FOR THERMAL S( $\alpha,\beta$ ) TABLES**

Data from thermal S( $\alpha,\beta$ ) tables (NTY=4) provide a complete representation of thermal neutron scattering by molecules and crystalline solids. Cross sections for elastic and inelastic scattering are found on the tables (typically for neutron energies below 4 eV). A coupled energy/angle representation is used to describe the spectra of inelastically scattered neutrons. Angular distributions for elastic scattering are also provided.

**APPENDIX F**  
**DATA BLOCKS FOR THERMAL  $S(\alpha,\beta)$  TABLES**

Four unique blocks of data are associated with  $S(\alpha,\beta)$  tables. We now briefly describe each of the four data blocks and give the table numbers in which their formats are detailed.

1. ITIE Block—contains the energy-dependent inelastic scattering cross sections. The ITIE Block always exists. See TABLE F-23.
2. ITCE Block—contains the energy-dependent elastic scattering cross sections. The ITCE Block exists if  $JXS(4) \neq 0$ . See TABLE F-24.
3. ITXE Block—contains coupled energy/angle distributions for inelastic scattering. The ITXE Block always exists. See TABLE F-25.
4. ITCA Block—contains angular distributions for elastic scattering. The ITCA Block exists if  $JXS(4) \neq 0$  and  $NXS(6) \neq -1$ . See TABLE F-26.

**TABLE F-23**  
**ITIE Block**

<u>Location in XSS</u>	<u>Parameter</u>	<u>Description</u>
JXS(1)	$NE_{in}$	Number of inelastic energies
JXS(1)+1	$E_{in}(I), I=1, NE_{in}$	Energies
JXS(1)+1+ $NE_{in}$	$\sigma_{in}(I), I=1, NE_{in}$	Inelastic cross sections

**Note:**  $JXS(2)=JXS(1)+1+NE_{in}$ . Linear-linear interpolation is assumed between adjacent energies.

**TABLE F-24**  
**ITCE Block**

<u>Location in XSS</u>	<u>Parameter</u>	<u>Description</u>
JXS(4)	$NE_{el}$	Number of elastic energies
JXS(4)+1	$E_{el}(I), I=1, NE_{el}$	Energies
JXS(4)+1+ $NE_{el}$	$P(I), I=1, NE_{el}$	(See Below)

If  $NXS(5) \neq 4$ :  $\sigma_{el}(I)=P(I)$ , with linear-linear interpolation between points

If  $NXS(5)=4$ :  $\sigma_{el}(E)=P(I)/E$ , for  $E_{el}(I)_i < E < E_{el}(I+1)$

Note:  $JXS(5)=JXS(3)+1+NE_{el}$

**TABLE F-25**  
**ITXE Block**

For NXS(2)=3 (equally-likely cosines; currently the only scattering mode allowed for inelastic angular distributions)

<u>Location in XSS</u>	<u>Parameter</u>	<u>Description</u>
JXS(3)	$E_1^{OUT} [E_{in}(1)]$	First of NXS(4) equally-likely outgoing energies for inelastic scattering at $E_{in}(1)$
JXS(3)+1	$\mu_I(1 \rightarrow 1)$ , I=1,NXS(3)+1	Equally-likely discrete cosines for scattering from $E_{in}(1)$ to $E_1^{OUT} [E_{in}(1)]$
JXS(3)+2+NXS(3)	$E_2^{OUT} [E_{in}(1)]$	Second of NXS(4) equally-likely outgoing energies for inelastic scattering at $E_{in}(1)$
JXS(3)+3+NXS(3)	$\mu_I(1 \rightarrow 2)$ , I=1,NXS(3)+1	Equally-likely discrete cosines for scattering from $E_{in}(1)$ to $E_2^{OUT} [E_{in}(1)]$
.	.	.
JXS(3)+(NXS(4)-1)* (NXS(3)+2)	$E_{NXS(4)}^{OUT} [E_{in}(1)]$	Last of NXS(4) equally-likely outgoing energies for inelastic scattering at $E_{in}(1)$
JXS(3)+(NXS(4)-1)* (NXS(3)+2)+1	$\mu_I(1 \rightarrow NXS(4))$ , I=1,NXS(3)+1	Equally-likely discrete cosines for scattering from $E_{in}(1)$ to $E_{NXS(4)}^{OUT} [E_{in}(1)]$
.	.	.
(Repeat for all remaining values of $E_{in}$ )		
.	.	.

Note: Incident inelastic energy grid  $E_{in}(I)$  is given in ITIE Block. Linear-linear interpolation is assumed between adjacent values of  $E_{in}$ .

**TABLE F-26**  
**ITCA Block**

<u>Location in XSS</u>	<u>Parameter</u>	<u>Description</u>
JXS(6)	$\mu_I[E_{el}(1)]$ , I=1,NXS(6)+1	Equally-likely discrete cosines for elastic scattering at $E_{el}(1)$
JXS(6)+NXS(6)+1	$\mu_I[E_{el}(2)]$ , I=1,NXS(6)+1	Equally-likely discrete cosines for elastic scattering at $E_{el}(2)$
.	.	.
JXS(6)+(NE <sub>el</sub> -1)* (NXS(6)+1)	$\mu_I[E_{el}(NE_{el})]$ , I=1,NXS(6)+1	Equally-likely discrete cosines for elastic scattering at $E_{el}(NE_{el})$

Note: Incident elastic energy grid  $E_{el}(I)$  and number of energies  $NE_{el}$  are given in ITCE Block. Linear-linear interpolation is assumed between adjacent values of  $E_{el}$ .

**APPENDIX F**  
**DATA BLOCKS FOR PHOTON TRANSPORT TABLES**

**VII. DATA BLOCKS FOR PHOTON TRANSPORT TABLES**

Only five data blocks are found on photon transport tables (NTY=5). Information contained on the blocks includes: cross sections for coherent and incoherent scattering, pair production, and the photoelectric effect; scattering functions and form factors that modify the differential Klein-Nishina and Thomson cross sections; energy deposition data; and fluorescence data. The five data blocks follow, with brief descriptions and table numbers where detailed formats may be found.

1. ESZG Block—contains the coherent, incoherent, photoelectric, and pair production cross sections, all tabulated on a common energy grid. The ESZG Block always exists. See TABLE F-27.
2. JINC Block—contains the incoherent scattering functions that are used to modify the differential Klein-Nishina cross section. The JINC Block always exists. See TABLE F-28.
3. JCOH Block—contains the coherent form factors that are used to modify the differential Thomson cross section. The JCOH Block always exists. See TABLE F-29.
4. JFLO Block—contains fluorescence data. The JFLO Block exists if NXS(4) ≠ 0. See TABLE F-30.
5. LHNM Block—contains average heating numbers. The LHNM Block always exists. See TABLE F-31.

**TABLE F-27**  
**ESZG Block**

<u>Location in XSS</u>	<u>Parameter</u>	<u>Description</u>
JXS(1)	$\ln[E(I), I=1, NXS(3)]$	Logarithms of energies
JXS(1)+NXS(3)	$\ln[\sigma_{IN}(I), I=1, NXS(3)]$	Logarithms of incoherent cross sections
JXS(1)+2*NXS(3)	$\ln[\sigma_{CO}(I), I=1, NXS(3)]$	Logarithms of coherent cross sections
JXS(1)+3*NXS(3)	$\ln[\sigma_{PE}(I), I=1, NXS(3)]$	Logarithms of photoelectric cross sections
JXS(1)+4*NXS(3)	$\ln[\sigma_{PP}(I), I=1, NXS(3)]$	Logarithms of pair production cross sections

Note: Linear-linear interpolation is performed on the logarithms as stored, resulting in effective log-log interpolation for the cross sections. If a cross section is zero, a value of 0.0 is stored on the data table.

**TABLE F-28**  
**JINC Block**

<u>Location in XSS</u>	<u>Parameter</u>	<u>Description</u>
JXS(2)	$FF_{INC}(I), I=1, 21$	Incoherent scattering functions



**APPENDIX F**  
**DATA BLOCKS FOR PHOTON TRANSPORT TABLES**

Note: The scattering functions for all elements are tabulated on a fixed set of  $v(I)$ , where  $v$  is the momentum of the recoil electron (in inverse angstroms). The grid is:  $v(I), I=1, 21 / 0. , .005 , .01 , .05 , .1 , .15 , .2 , .3 , .4 , .5 , .6 , .7 , .8 , .9 , 1. , 1.5 , 2. , 3. , 4. , 5. , 8. /$   
Linear-linear interpolation is assumed between adjacent  $v(I)$ .  
The constants  $v(I)$  are stored in the VIC array in common block RBLDAT.

**TABLE F-29**  
**JCOH Block**

<u>Location in XSS</u>	<u>Parameter</u>	<u>Description</u>
JXS(3)	FFINT <sub>COH</sub> (I), I=1,55	Integrated coherent form factors
JXS(3)+55	FF <sub>COH</sub> (I), I=1,55	Coherent form factors

Note: The form factors for all elements are tabulated on a fixed set of  $v(I)$ , where  $v$  is the momentum transfer of the recoil electron (in inverse angstroms). The grid is:  $v(I), I=1, 55 / 0. , .01 , .02 , .03 , .04 , .05 , .06 , .08 , .10 , .12 , .15 , .18 , .20 , .25 , .30 , .35 , .40 , .45 , .50 , .55 , .60 , .70 , .80 , .90 , 1.0 , 1.1 , 1.2 , 1.3 , 1.4 , 1.5 , 1.6 , 1.7 , 1.8 , 1.9 , 2.0 , 2.2 , 2.4 , 2.6 , 2.8 , 3.0 , 3.2 , 3.4 , 3.6 , 3.8 , 4.0 , 4.2 , 4.4 , 4.6 , 4.8 , 5.0 , 5.2 , 5.4 , 5.6 , 5.8 , 6.0 /$   
The integrated form factors are tabulated on a fixed set of  $v(I)^2$ , where the  $v(I)$  are those defined above. See LA-5157-MS for a description of the integrated form factors and the sampling technique used in MCNP. The constants  $v(I)$  are stored in the VCO array. The constants  $v(I)^2$  are stored in the WCO array. Both arrays are in common block RBLDAT.

**TABLE F-30**  
**JFLO Block**

<u>Location in XSS</u>	<u>Parameter</u>	<u>Description</u>
JXS(4)	e(1),...,e(NXS(4))	(See Below)
JXS(4) + NXS(4)	Φ(1),...,Φ(NXS(4))	(See Below)
JXS(4) + 2*NXS(4)	Y(1),...,Y(NXS(4))	(See Below)
JXS(4) + 3*NXS(4)	F(1),...,F(NXS(4))	(See Below)
.	.	.
.	.	.
.	.	.

A complete description of the parameters given in this block can be found in LA-5240-MS.  
Briefly:

- e(I) are the edge energies
- Φ(I) are relative probabilities of ejection from various shells
- Y(I) are yields and
- F(I) are fluorescent energies.

**APPENDIX F**  
**FORMAT FOR MULTIGROUP TRANSPORT TABLES**

**TABLE F-31**  
**LHNM Block**

<u>Location in XSS</u>	<u>Parameter</u>	<u>Description</u>
JXS(5)	$H_{ave}(I), I=1, NXS(3)$	Average heating numbers

Note: Log-log interpolation is performed between adjacent heating numbers. The units of  $H_{ave}$  are MeV per collision. Heating numbers are tabulated on the energy grid given in the ESZG Block.

**VIII. FORMAT FOR MULTIGROUP TRANSPORT TABLES**

**TABLE F-32**  
**NXS Array**

	<u>Parameter</u>	<u>Description</u>
NXS(1)	LDB	Length of second block of data
NXS(2)	ZA	1000*Z+A for neutrons, 1000*Z for photons
NXS(3)	NLEG	Number of angular distribution variables
NXS(4)	NEDIT	Number of edit reactions
NXS(5)	NGRP	Number of groups
NXS(6)	NUS	Number of upscatter groups
NXS(7)	NDS	Number of downscatter groups
NXS(8)	NSEC	Number of secondary particles
NXS(9)	ISANG	Angular distribution type ISANG=0 for equiprobable cosines bins ISANG=1 for discrete cosines
NXS(10)	NNUBAR	Number of nubars given
NXS(11)	IBFP	Boltzmann-Fokker-Planck indicator IBFP=0 for Boltzmann only IBFP=1 for Boltzmann-Fokker-Planck IBFP=2 for Fokker-Planck only
NXS(12)	IPT	Identifier for incident particle IPT=1 for neutrons IPT=2 for photons IPT=0 for other particles (temporary)

NXS(13)–NXS(16) are presently unused

All data in the NXS Array is appropriate for the incident particle only.

**TABLE F-33**  
**JXS Array**

Parameter	Description
JXS(1)	LERG Location of incident particle group structure=1
JXS(2)	LTOT Location of total cross sections
JXS(3)	LFISS Location of fission cross sections
JXS(4)	LNU Location of nubar data
JXS(5)	LCHI Location of fission chi data
JXS(6)	LABS Location of absorption cross sections
JXS(7)	LSTOP Location of stopping powers
JXS(8)	LMOM Location of momentum transfers
JXS(9)	LMTED Location of edit reaction numbers
JXS(10)	LXSED Location of edit cross sections
JXS(11)	LIPT Location of secondary particle types
JXS(12)	LERG2L Location of secondary group structure locators
JXS(13)	LPOL Location of P0 locators
JXS(14)	LSANG2 Location of secondary angular distribution types
JXS(15)	LNLEG2 Location of number of angular distribution variables for secondaries
JXS(16)	LXPNL Location of $XP_N$ locators
JXS(17)	LPNL Location of $P_N$ locators
JXS(18)	LSIGMA Location of SIGMA Block locators
JXS(19)	LSIGSC Location of cumulative P0 scattering cross sections
JXS(20)	LSIGSCS Location of cumulative P0 scattering cross sections to secondary particle

Notes: JXS(18)–JXS(20) are calculated and used internally in MCNP. These parameters have a value of 0 on the cross-section file.  
 JXS(21)–JXS(32) are presently unused.

**TABLE F-34**  
**ERG Block**

Location	Parameter	Description
JXS(1)	ECENT(1)	Center energy of group 1
.	.	.
.	.	.
JXS(1)+NXS(5)–1	ECENT(NXS(5))	Center energy of Group NXS(5)
JXS(1)+NXS(5)	EWID(1)	Width of Group 1
.	.	.
.	.	.
JXS(1)+2*NXS(5)–1	EWID(NXS(5))	Width of Group NXS(5)

**APPENDIX F  
 FORMAT FOR MULTIGROUP TRANSPORT TABLES**

**TABLE F-34 (Cont.)  
 ERG Block**

JXS(1)+2*NXS(5)	GMASS(1)	Mass of Group-1 particle
.	.	.
JXS(1)+3*NXS(5)-1	GMASS(NXS(5))	Mass of Group – NXs(5) particle

Notes: Group masses are given only if NXs(12)=0.  
 All entries are in MeV.  
 Group energies are descending, unless NXs(12)=0, in which case there may be discontinuities.

Length: 2\*NXS(5) if NXs(12) ≠ 0; 3\*NXS(5) if NXs(12)=0

Exists: Always

**TABLE F-35  
 TOT Block**

Location	Parameter	Description
JXS(2)	SIGTOT(1)	Total cross section in Group 1
.	.	.
JXS(2)+NXs(5)-1	SIGTOT(NXS(5))	Total cross section in Group NXs(5)

Length: NXs(5)

Exists: If JXS(2) ≠ 0

**TABLE F-36  
 FISS Block**

Location	Parameter	Description
JXS(3)	SIGFIS(1)	Fission cross section in Group 1
.	.	.
JXS(3)+NXs(5)-1	SIGFIS(NXS(5))	Fission cross section in Group NXs(5)

Length: NXs(5)

Exists: If JXS(3) ≠ 0

**TABLE F-37**  
**NU Block**

Location	Parameter	Description
JXS(4)	NUBAR(1)	See below
.	.	.
.	.	.
JXS(4)+NXS(10)*NXS(5)-1	NUBAR(NXS(10)*NXS(5))	See below

**Note:** If NXS(10)=1, then one set of nubars is given (NUBAR(1) → NUBAR(NXS(5))).  
The nubars may be either prompt or total.

If NXS(10) = 2, then both prompt and total nubars are given. In this case, NUBAR(1) → NUBAR(NXS(5)) are prompt nubars and NUBAR(NXS(5)+1) → NUBAR (2\*NXS(5)) are total nubars.

Length: NXS(5)\*NXS(10)

Exists: If JXS(3) ≠ 0

**TABLE F-38**  
**CHI Block**

Location	Parameter	Description
JXS(5)	FISFR(1)	Group 1 fission fraction
.	.	.
.	.	.
JXS(5)+NXS(5)-1	FISFR(NXS(5))	Group NXS(5) fission fraction

**Note:** The fission fractions are normalized so that their sum is 1.0.

Length: NXS(5)

Exists: If JXS(3) ≠ 0

**APPENDIX F**  
**FORMAT FOR MULTIGROUP TRANSPORT TABLES**

**TABLE F-39**  
**ABS Block**

Location	Parameter	Description
JXS(6)	SIGABS(1)	Absorption cross section in Group 1
.	.	.
JXS(6)+NXS(5)-1	SIGABS(NXS(5))	Absorption cross section in Group NXS(5)

Length: NXS(5)

Exists: If JXS(6) ≠ 0

**TABLE F-40**  
**STOP Block**

Location	Parameter	Description
JXS(7)	SPOW(1)	Stopping power in Group 1
.	.	.
JXS(7)+NXS(5)-1	SPOW(NXS(5))	Stopping power in Group NXS(5)

Length: NXS(5)

Exists: If JXS(7) ≠ 0

**TABLE F-41**  
**MOM Block**

Location	Parameter	Description
JXS(8)	MOMTR(1)	Momentum transfer in Group 1
..	.	.
JXS(8)+NXS(5)-1	MOMTR(NXS(5))	Momentum transfer in Group NXS(5)

Length: NXS(5)

Exists: If JXS(8) ≠ 0

**TABLE F-42**  
**MTED Block**

Location	Parameter	Description
JXS(9)	MT(1)	Identifier for edit reaction 1
.	.	..
.	.	.
JXS(9)+NXS(4)-1	MT(NXS(4))	Identifier for edit reaction NXs(4)

Length: NXs(4)

Exists: If JXS(4) ≠ 0

**TABLE F-43**  
**XSED Block**

Location	Parameter	Description
JXS(10)	XS(1,1)	Edit cross section for reaction 1, Group 1
.	.	.
.	.	.
JXS(10)+NXS(5)-1	XS(1,NXS(5))	Edit cross section for reaction 1, Group NXs(5)
.	.	.
.	.	.
JXS(10)+(NXs(4)-1) *(NXs(5))	XS(NXS(4),1)	Edit cross section for reaction NXs(4), Group 1
.	.	.
.	.	.
JXS(10)+NXS(4)*NXs(5)-1	XS(NXS(4), NXs(5))	Edit cross section for reaction NXs(4), Group NXs(5)

Length: NXs(4)\*NXs(5)

Exists: If NXs(4) ≠ 0

**APPENDIX F  
 FORMAT FOR MULTIGROUP TRANSPORT TABLES**

**TABLE F-44  
 IPT Block**

Location	Parameter	Description
JXS(11)	IPT(1)	Identifier for secondary particle 1
.	.	.
.	.	.
JXS(11)+NXS(8)-1	IPT(NXS(8))	Identifier for secondary particle NXs(8)

Note: Present values of IPT are:  
 IPT=1 for neutrons,  
 IPT=2 for photons

Length: NXs(8)

Exists: If NXs(8) ≠ 0

**TABLE F-45  
 ERG2L Block**

Location	Parameter	Description
JXS(12)	LERG2(1)	Location of ERG2 Block* for secondary particle 1
.	.	.
JXS(12)+NXS(8)-1	LERG2(NXS(8))	Location of ERG2 Block* for secondary particle NXs(8)

Length: NXs(8)

Exists: If NXs(8) ≠ 0

**\*The ERG2 Block for secondary particle i is of the form:**

Location	Parameter	Description
LERG2(i)	NERG(i)	Number of energy groups for secondary particle i
LERG2(i)+1	ECENT2(1)	Center energy of Group 1 for secondary particle i
.	.	.
.	.	.



**APPENDIX F**  
**FORMAT FOR MULTIGROUP TRANSPORT TABLES**

LERG2(i)+NERG(i)	ECENT2(NERG(i))	Center energy of Group NERG(i) for secondary particle i
LERG2(i)+NERG(i)+1	EWID2(1)	Width of Group 1 for secondary particle i
.	.	.
.	.	.
LERG2(i)+2*NERG(i)	EWID2(NERG(i))	Width of Group NERG(i) for secondary particle i

Note: Values of LERG2(i) are from ERG2L Block. Group energies are descending.

Length: 2\*NERG(i)+1

Exists: If NXS(8) ≠ 0, then ERG2 Block is repeated NXS(8) times.

**TABLE F-46**  
**POL Block**

Location	Parameter	Description
JXS(13)	LPO(1)	Location of P0 Block* for incident particle
.	.	.
JXS(13)+NXS(8)	LPO(NXS(8)+1)	Location of P0 Block* for secondary particle NXS(8)

Length: NXS(8)+1

Exists: If JXS(13) ≠ 0

**\*The PO Block for particle i is of the form:**

Location	Parameter	Description
LPO(i)	SIG(1 → 1)	P0 cross section for scattering from incident particle Group 1 to exiting particle Group 1
.	.	.
LPO(i+L - 1)	SIG(NXS(5) → K)	P0 cross section for scattering from incident particle group NXS(5) to exiting particle Group K

Note: See TABLE F-54 for a complete description of the ordering and length of the P0 block.

Exists: If JXS(13) ≠ 0, then the P0 Block is repeated NXS(8)+1 times.

**APPENDIX F**  
**FORMAT FOR MULTIGROUP TRANSPORT TABLES**

**TABLE F-47**  
**SANG2 Block**

Location	Parameter	Description
JXS(14)	ISANG2(1)	Angular distribution type for secondary particle 1
.	.	.
JXS(14)+NXS(8)-1	ISANG2(NXS(8))	Angular distribution type for secondary particle NXs(8)

Note: ISANG2(i)=0 for equiprobable cosine bins; ISANG2(i)=1 for discrete cosines.

Length: NXs(8)

Exists: If NXs(8) ≠ 0

**TABLE F-48**  
**NLEG2 Block**

Location	Parameter	Description
JXS(15)	NLEG2(1)	Number of angular distribution variables for secondary particle 1
.	.	.
JXS(15)+NXS(8)-1	NLEG2(NXS(8))	Number of angular distribution variables for secondary particle NXs(8)

Length: NXs(8)

Exists: If NXs(8) ≠ 0

**TABLE F-49**  
**XPNL Block**

Location	Parameter	Description
JXS(16)	LXPN(1)	Location of XPN Block* for incident particle
.	.	.
JXS(16)+NXS(8)	LXPN(NXS(8)+1)	Location of XPN Block* for secondary particle NXs(8)

Note: If LXPN(i)=0, then all possible scattering is isotropic and no XPN block exists.

Length: NXs(8)+1

Exists: If JXS(13) ≠ 0

**\*The XPN Block for particle i is of the form:**

Location	Parameter	Description
LXPN(i)	LPND(1 → 1)	Location of PND Block <sup>†</sup> for scattering from incident particle Group 1 to exiting particle Group 1
.	.	.
LXPN(i+L - 1)	LPND(NXS(5) → K)	Location of PND Block <sup>†</sup> for scattering from incident particle Group NXs(5) to exiting particle Group K

<sup>†</sup> See TABLE F-50 for a description of the PND Block

**Note:** See TABLE F-54 for a complete description of the ordering and length of the XPN Block. Also see the notes to the PN Block in TABLE F-50 for more complete description of the meanings of the LPND parameters.

Exists: If JXS(13) ≠ 0, then the XPN Block is repeated NXs(8)+1 times.

**APPENDIX F  
 FORMAT FOR MULTIGROUP TRANSPORT TABLES**

**TABLE F-50  
 PNL Block**

Location	Parameter	Description
JXS(17)	LPN(1)	Location of PN Block* for incident particle
.	.	.
JXS(17)+NXS(8)	LPN(NXS(8)+1)	Location of PN Block* for secondary particle NXs(8)

Note: If LPN(i)=0, then all possible scattering is isotropic and no PN Block exists.

Length: NXs(8)+1

Exists: If JXS(13) ≠ 0.

**\*The PN Block for particle i is of the form:**

Location	Parameter	Description
LPN(i)+LPND(1 → 1)-1	PND(1 → 1,I) I=1,NLEG(i)	Angular distribution data for scattering from incident particle Group 1 to exiting particle Group 1
.	.	.
LPN(i)+LPND(NXS(5) → K)-1	PND(NXS(5) → K,I), I=1, NLEG(i)	Angular distribution data for scattering from incident particle Group NXs(5) to exiting particle Group K

**Note:** Values of LPND are from the XPN Block (see TABLE F-49). Values of LPN(i) are from the PNL Block. If LPND>0, then data exists in the PN Block as described above. If LPND=0, scattering is isotropic in the laboratory system and no data exist in the PN Block. If LPND=-1, then scattering is impossible for the combination of incident and exiting groups; again no data exist in the PN Block. The appropriate value of NLEG is found in TABLE F-32 or TABLE F-48. The value of ISANG (from TABLE F-32 or TABLE F-47) determines what data are found in the PND array. If ISANG=0, then PND contains NLEG cosines, which are boundaries of NLEG-1 equiprobable cosine bins. If ISANG=1, then PND contains (NLEG-1)/2 cumulative probabilities followed by (NLEG+1)/2 discrete cosines. The cumulative probability corresponding to the final discrete cosine is defined to be 1.0.

Exists: If JXS(13) ≠ 0, then the PN Block is repeated NXs(8)+1 times.

**TABLE F-51**  
**SIGMA Block\***

Location	Parameter	Description
JXS(18)	SCAT <sub>gg</sub> (1)	Location of the within-group scattering cross section for group 1 within the P0 Block
.	.	.
JXS(18)+NXS(5)-1	SCAT <sub>gg</sub> (NXS(5))	Location of the within-group scattering cross section for group NXS(5) in the P0 Block

**TABLE F-52**  
**SIGSC Block\***

Location	Parameter	Description
JXS(19)	SIGSC(1)	Total P0 scattering cross section for group 1 excluding scattering to secondary particle
.	.	.
JXS(19)+NXS(5)-1	SIGSC(NXS(5))	Total P0 scattering cross section for group NXS(5) excluding scattering to secondary particle

**TABLE F-53**  
**SIGSCS Block\***

Location	Parameter	Description
JXS(20)	SIGSCS(1)	Total P0 scattering cross section to a secondary particle for group 1
.	.	.
JXS(20)+NXS(5)-1	SIGSCS(NXS(5))	Total P0 scattering cross section to a secondary particle for group NXS(5)

---

\*The SIGMA, SIGSC and SIGSCS Blocks are calculated and used internally within MCNP and do not actually appear on the cross-section file.

**APPENDIX F**  
**FORMAT FOR ELECTRON TRANSPORT TABLES**

**TABLE F-54**  
 Additional Information for P0 and XPN Blocks

1. Ordering

Entries in these blocks always start with data for scattering from the highest energy group of the incident particle to the highest energy group of the exiting particle. The last entry is always data for scattering from the lowest energy group of the exiting particle. The remaining entries are ordered according to the following prescription:

X(1→J), J=I1(1), I2(1),  
 X(2→J), J=I1(2), I2(2),  
 .  
 .  
 .  
 X(NXS(5)→J), J=I1(NXS(5)), I2(NXS(5)).

If the incident and exiting particles are the same:

I1(K)=MAX(1,K-NXS(6)),  
 I2(K)=MIN(NXS(5),K+NXS(7)).

If the incident and exiting particles are different:

I1(K)=1,  
 I2(K)=NERG(i) for the appropriate secondary particle from TABLE F-45.

2. Length

If the incident and exiting particles are the same:

$$L = NXS(5) * (1 + NXS(7) + NXS(6)) - \frac{(NXS(7) * (NXS(7) + 1)) + (NXS(6) * (NXS(6) + 1))}{2}$$

If the incident and exiting particles are different:

L = NXS(5)\*NERG(i), where NERG(i) is for the appropriate secondary particle from TABLE F-45.

**IX. FORMAT FOR ELECTRON TRANSPORT TABLES**

This Section not written yet.

## APPENDIX G

### NEUTRON CROSS-SECTION LIBRARIES

This appendix is divided into five sections. Section I lists some of the more frequently used ENDF/B reaction types that can be used with the FMn input card. TABLE G-1 in Section II lists the currently available  $S(\alpha, \beta)$  data available for use with the MTm card. Section III provides a brief description of the available continuous-energy and discrete neutron data libraries. TABLE G-2 in Section III is a list of the continuous-energy and discrete neutron data libraries maintained by X-5. Section IV describes the multigroup data library MGXSNP (TABLE G-3), and Section V describes the dosimetry data libraries (TABLE G-4).

#### I. ENDF/B REACTION TYPES

The following partial list includes some of the more useful reactions for use with the FMn input card and with the cross-section plotter (see pages 3-87 and B-10.) The complete ENDF/B list can be found in the ENDF/B manual.<sup>1</sup> The MT column lists the ENDF/B reaction number. The FM column lists special MCNP reaction numbers that can be used with the FM card and cross-section plotter.

Generally only a subset of reactions are available for a particular nuclide. Some reaction data are eliminated by MCNP in cross-section processing if they are not required by the problem. Examples are photon production in a MODE N problem, or certain reaction cross sections not requested on an FM card. FM numbers should be used when available, rather than MT numbers. If an MT number is requested, the equivalent FM number will be displayed on the legend of cross-section plots.

Neutron Continuous-energy and Discrete:

<u>MT</u>	<u>FM</u>	<u>Microscopic Cross-Section Description</u>
1	-1	Total (see note 1 following)
2	-3	Elastic (see note 1 following)
16		(n,2n)
17		(n,3n)
18		Total fission (n,fx) if and only if MT=18 is used to specify fission in the original evaluation.
	-6	Total fission cross section. (equal to MT=18 if MT=18 exists; otherwise equal to the sum of MTs 19, 20, 21, and 38.)
19		(n,f)
20		(n,n'f)
21		(n,2nf)
22		(n,n'α)

**APPENDIX G**  
**ENDF/B REACTION TYPES**

28		(n,n'p)
32		(n,n'd)
33		(n,n't)
38		(n,3nf)
51		(n,n') to 1 <sup>st</sup> excited state
52		(n,n') to 2 <sup>nd</sup> excited state
.		.
90		(n,n') to 40 <sup>th</sup> excited state
91		(n,n') to continuum
101	-2	Absorption: sum of MT=102-117 (neutron disappearance; does not include fission)
102		(n, $\gamma$ )
103		(n,p)
104		(n,d)
105		(n,t)
106		(n, <sup>3</sup> He)
107		(n, $\alpha$ )

In addition, the following special reactions are available for many nuclides:

202	-5	total photon production
203		total proton production (see note 3 following)
204		total deuterium production (see note 3 following)
205		total tritium production (see note 3 following)
206		total <sup>3</sup> He production (see note 3 following)
207		total alpha production (see note 3 following)
301	-4	average heating numbers (MeV/collision)
	-7	nubar (prompt or total)
	-8	fission Q (in print table 98, but not plots)

S( $\alpha$ , $\beta$ ):

<u>MT</u>	<u>FM</u>	<u>Microscopic Cross-Section Description</u>
1		Total cross section
2		Elastic scattering cross-section
4		Inelastic scattering cross-section

Neutron and Photon Multigroup:

<u>MT</u>	<u>FM</u>	<u>Microscopic Cross-Section Description</u>
1	-1	Total cross section
18	-2	Fission cross section



	-3	Nubar data
	-4	Fission chi data
101	-5	Absorption cross section
	-6	Stopping powers
	-7	Momentum transfers
n		Edit reaction n
202		Photon production
301		Heating number
318		Fission Q
401		Heating number times total cross section

Photons (see note 4 following):

<u>MT</u>	<u>FM</u>	<u>Microscopic Cross-Section Description</u>
501	-5	Total
504	-1	Incoherent (Compton + Form Factor)
502	-2	Coherent (Thomson + Form Factor)
522	-3	Photoelectric with fluorescence
516	-4	Pair production
301	-6	Heating number

Electrons (see note 5 following):

<u>MT</u>	<u>FM</u>	<u>Microscopic Cross-Section Description</u>
	1	de/dx electron collision stopping power
	2	de/dx electron radiative stopping power
	3	de/dx total electron stopping power
	4	electron range
	5	electron radiation yield
	6	relativistic $\beta^2$
	7	stopping power density correction
	8	ratio of rad/col stopping powers
	9	drange
	10	dyield
	11	rng array values
	12	qav array values
	13	ear array values

## APPENDIX G

### ENDF/B REACTION TYPES

#### Notes:

1. At the time they are loaded, the total and elastic cross sections from the data library are thermally adjusted by MCNP to the temperature of the problem, if that temperature is different from the temperature at which the cross-section set was processed (see page 2–29.) If different cells have different temperatures, the cross sections first are adjusted to zero degrees and adjusted again to the appropriate cell temperatures during transport. The cross-section plot will *never* display the *transport* adjustment. Therefore, for plotting, reactions 1 and –1 are equivalent and reactions 2 and –3 are equivalent. But for the FM card, reactions –1 and –3 will use the zero degree data and reactions 1 and 2 will use the transport-adjusted data.  
For example, if a library evaluated at 300° is used in a problem with cells at 400° and 500°, the cross-section plotter and MT=–1 and MT=–3 options on the FM card will use 0° data. The MT=1 and MT=2 options on the FM card will use 400° and 500° data.
2. The nomenclature between MCNP and ENDF/B is sometimes inconsistent in that MCNP often refers to the number of the reaction type as R whereas ENDF/B uses MT. They are one and the same, however. The problem arises because MCNP has an MT input card used for the  $S(\alpha,\beta)$  thermal treatment.
3. The user looking for total production of p, d, t,  $^3\text{He}$  and  $^4\text{He}$  should be warned that in some evaluations, such processes are represented using reactions with MT (or R) numbers other than the standard ones given in the above list. This is of particular importance with the so-called “pseudolevel” representation of certain reactions which take place in light isotopes. For example, the ENDF/B-V evaluation of carbon includes cross sections for the (n,n’ $3\alpha$ ) reaction in MT = 52 to 58. The user interested in particle production from light isotopes should check for the existence of pseudolevels and thus possible deviations from the above standard reaction list.
4. There are two photon transport libraries maintained by X-5, MCPLIB and MCPLIB02.<sup>2,3</sup> The photon library MCPLIB provides data for transporting photons with energies from 1 keV to 100 MeV. The default photon library MCPLIB02 provides data up to 100 GeV. Photon transport data are not provided for  $Z > 94$ , and coupled neutron-photon problems cannot be run for these nuclides.
5. X-5 maintains one electron transport library, EL. The MT numbers used for xs plotting are taken from Print Table 85 columns and are not from ENDF.

*II. S(α,β) DATA FOR USE WITH THE MT<sub>m</sub> CARD*

**TABLE G-1**  
**Thermal S(α,β) Cross-Section Libraries**

ZAID	<u>Date of Processing</u>	Material Description	Nuclides*	<u>Temp (°K)</u>
THERXS1 (Source: LANL)				
smeth.01t	04/10/88	Solid methane	1001	22
lmeth.01t	04/10/88	Liquid methane	1001	100
hpara.01t	03/03/89	Para H	1001	20
hortho.01t	03/03/89	Ortho H	1001	20
dpara.01t	05/30/89	Para D	1002	20
dortho.01t	05/30/89	Ortho D	1002	20
TMCCS1 (Source: ENDF)				
lwtr.01t	10/22/85	H in light water	1001	300
lwtr.02t	10/22/85	H in light water	1001	400
lwtr.03t	10/22/85	H in light water	1001	500
lwtr.04t	10/22/85	H in light water	1001	600
lwtr.05t	10/22/85	H in light water	1001	800
poly.01t	10/22/85	H in polyethylene	1001	300
h/zr.01t	10/22/85	H in Zr-hydride	1001	300
h/zr.02t	10/22/85	H in Zr-hydride	1001	400
h/zr.04t	10/22/85	H in Zr-hydride	1001	600
h/zr.05t	10/22/85	H in Zr-hydride	1001	800
h/zr.06t	10/22/85	H in Zr-hydride	1001	1200
benz.01t	09/08/86	Benzene	1001, 6000, 6012	300
benz.02t	09/08/86	Benzene	1001, 6000, 6012	400
benz.03t	09/08/86	Benzene	1001, 6000, 6012	500
benz.04t	09/08/86	Benzene	1001, 6000, 6012	600
benz.05t	09/08/86	Benzene	1001, 6000, 6012	800
hwtr.01t	10/22/85	D in heavy water	1002	300
hwtr.02t	10/22/85	D in heavy water	1002	400
hwtr.03t	10/22/85	D in heavy water	1002	500
hwtr.04t	10/22/85	D in heavy water	1002	600
hwtr.05t	10/22/85	D in heavy water	1002	800

**APPENDIX G**  
**MCNP NEUTRON CROSS-SECTION LIBRARIES**

**TABLE G-1 (Cont.)**  
**Thermal  $S(\alpha,\beta)$  Cross-Section Libraries**

<b>ZAID</b>	<b>Date of Processing</b>	<b>Material Description</b>	<b>Nuclides*</b>	<b>Temp (°K)</b>
be.01t	10/24/85	Be metal	4009	300
be.04t	10/24/85	Be metal	4009	600
be.05t	10/24/85	Be metal	4009	800
be.06t	10/24/85	Be metal	4009	1200
beo.01t	09/08/86	Be oxide	4009, 8016	300
beo.04t	09/08/86	Be oxide	4009, 8016	600
beo.05t	09/08/86	Be oxide	4009, 8016	800
beo.06t	09/08/86	Be oxide	4009, 8016	1200
grph.01t	09/08/86	Graphite	6000, 6012	300
grph.04t	09/08/86	Graphite	6000, 6012	600
grph.05t	09/08/86	Graphite	6000, 6012	800
grph.06t	09/08/86	Graphite	6000, 6012	1200
grph.07t	09/08/86	Graphite	6000, 6012	1600
grph.08t	09/08/86	Graphite	6000, 6012	2000
zr/h.01t	09/08/86	Zr in Zr-hydride	40000	300
zr/h.02t	09/08/86	Zr in Zr-hydride	40000	400
zr/h.04t	09/08/86	Zr in Zr-hydride	40000	600
zr/h.05t	09/08/86	Zr in Zr-hydride	40000	800
zr/h.06t	09/08/86	Zr in Zr-hydride	40000	1200

\*Nuclides for which the  $S(\alpha,\beta)$  data are valid. For example, lwtr.01t provides scattering data only for  $^1\text{H}$ ;  $^{16}\text{O}$  would still be represented by the default free-gas treatment.

**III. MCNP NEUTRON CROSS-SECTION LIBRARIES**

TABLE G-2 lists all the continuous-energy and discrete neutron data libraries maintained by X-5. The entries in each of the columns of TABLE G-2 are described as follows:

**ZAID** – The nuclide identification number with the form  $ZZZAAA.nnX$   
 where  $ZZZ$  is the atomic number,  
 $AAA$  is the mass number (000 for naturally occurring elements),  
 $nn$  is the neutron cross-section identifier  
 $X=C$  for continuous-energy neutron tables  
 $X=D$  for discrete-reaction tables

**ATOMIC** – The atomic weight ratio (AWR) is the ratio of the atomic mass of the

**APPENDIX G**  
**MCNP NEUTRON CROSS-SECTION LIBRARIES**

**WEIGHT –** nuclide to a neutron. This is the AWR that is contained in the original  
**RATIO –** evaluation and that was used in the NJOY processing of the evaluation.

**LIBRARY –** Name of the library that contains the data file for that ZAID. The number in brackets following a file name refers to one of the special notes at the end of TABLE G-2.

**SOURCE –** Indicates the originating evaluation for that data file.

ENDF/B-V.# or ENDF/B-VI.# ( such as B-V.0 and B-VI.1) are the Evaluated Nuclear Data Files, a US effort coordinated by the National Nuclear Data Center at Brookhaven National Laboratory. The evaluations are updated periodically by evaluators from all over the country, and the release number of the evaluation is given. This is not necessarily the same as the ENDF revision number for that evaluation. For example, Pu-242 is noted as ENDF/B-VI.2 as it is from release 2 of ENDF/B-VI, but it is revision 1 of that evaluation.

LLNL – evaluated nuclear data libraries compiled by the Nuclear Data Group at Lawrence Livermore National Laboratory. The number in the library name indicates the year the library was produced or received.

T-2 – evaluations from the Nuclear Theory and Applications group T-2 at Los Alamos National Laboratory.

—:T-2 or —:X-5 – indicates the original evaluation has been modified by the Los Alamos National Laboratory groups T-2 or X-5.

**DATE of -** Denotes the year that the evaluation was completed or accepted. In  
**EVALUATION –** cases where this information is not known, the date that data library was produced is given. If minor corrections were made to an evaluation, the original evaluation date was kept. The notation “<1985” means “before” 1985.

**TEMP –** Indicates the temperature (°K) at which the data were processed. The temperature enters into the processing of the evaluation into a data file only through the Doppler broadening of cross sections. The user must be aware that without the proper use of the TMP card, MCNP will attempt to correct the data libraries to the default 300°K by modifying the elastic and total cross sections only.

Doppler broadening refers to a change in cross section resulting from thermal motion (translation, rotation and vibration) of nuclei in a target material. Doppler broadening is done on all cross sections for incident neutrons (nonrelativistic energies) on a target at some temperature (TEMP) in which the free-atom approximation is valid. In

## APPENDIX G

### MCNP NEUTRON CROSS-SECTION LIBRARIES

general an increase in the temperature of the material containing neutron-absorbing nuclei in a homogeneous system results in Doppler broadening of resonances and an increase in resonance absorption. Furthermore, a constant cross section at zero °K goes to  $1/v$  behavior as the temperature increases. You should not only use the best evaluations but also use evaluations that are at temperatures approximating the temperatures in your application.

LENGTH – The total length of a particular cross-section file in words. It is understood that the actual storage requirement in an MCNP problem will often be less because certain data that are not needed for a problem may be expunged.

NUMBER of – The number of energy points on the grid used for the neutron cross  
ENERGIES – section for that data file. In general, a finer energy grid (or greater number of points) indicates a more accurate representation of the cross sections, particularly through the resonance region.

$E_{max}$  – The maximum incident neutron energy for that data file. For all incident neutron energies greater than  $E_{max}$ , MCNP assumes the last cross section value given.

GPD – “yes” means that photon-production data are included;  
“no” means that such data are not included.

$\bar{\nu}$  – for fissionable material,  $\bar{\nu}$  indicates the type of fission nu data available.  
“pr” means that only prompt nu data are given;  
“tot” means that only total nu data are given;  
“both” means that prompt and total nu are given.

CP “yes” means that secondary charged-particles data are present;  
“no” means that such data are not present.

DN “yes” means that delayed neutron data are present;  
“no” means that such data are not present.

UR “yes” means that unresolved resonance data are present;  
“no” means that such data are not present.

TABLE G-2 contains no indication of a “recommended” library for each isotope. Because of the wide variety of applications, no one set is “best.” The default cross-section set for each isotope is determined by the XSDIR file being used (see page 2–21.)

Finally, you can introduce a cross-section library of your own by using the XS input card.

APPENDIX G  
MCNP NEUTRON CROSS-SECTION LIBRARIES

**TABLE G-2**  
**Continuous-Energy and Discrete Neutron Data Libraries Maintained by X-5**

Z	AWR	Library Name	Source	Eval Date	Temp (°K)	Length words	NE	E <sub>max</sub> MeV	GPD	$\bar{U}$	CP	DN	UR
Z = 1 ***** Hydrogen *****													
** H-1 **													
	0.9992	endl85	LLNL	<1985	0.0	3506	330	20.0	yes	no	no	no	no
	0.9992	endl92	LLNL	<1992	300.0	1968	121	30.0	yes	no	no	no	no
	0.9992	rmccs	B-V.0	1977	293.6	2766	244	20.0	yes	no	no	no	no
	0.9992	drmccs	B-V.0	1977	293.6	3175	263	20.0	yes	no	no	no	no
	0.9992	endf5mt[1]	B-V.0	1977	587.2	4001	394	20.0	yes	no	no	no	no
	0.9992	endf60	B-VI.1	1989	293.6	3484	357	100.0	yes	no	no	no	no
** H-2 **													
	1.9968	endl85	LLNL	<1985	0.0	2507	135	20.0	yes	no	no	no	no
	1.9968	endf5p	B-V.0	1967	293.6	3987	214	20.0	yes	no	no	no	no
	1.9968	dre5	B-V.0	1967	293.6	4686	263	20.0	yes	no	no	no	no
	1.9968	rmccs	T-2	1982	293.6	5981	285	20.0	yes	no	no	no	no
	1.9968	drmccs	T-2	1982	293.6	5343	263	20.0	yes	no	no	no	no
	1.9968	endf60	B-VI.0	1967[2]	293.6	2704	178	20.0	yes	no	no	no	no
** H-3 **													
	2.9901	endl85	LLNL	<1985	0.0	1269	76	20.0	no	no	no	no	no
	2.9901	endl92	LLNL	<1992	300.0	2308	52	30.0	no	no	no	no	no
	2.9901	rmccs	B-V.0	1965	293.6	2428	184	20.0	no	no	no	no	no
	2.9901	drmccs	B-V.0	1965	293.6	2807	263	20.0	no	no	no	no	no
	2.9901	endf60	B-VI.0	1965	293.6	3338	180	20.0	no	no	no	no	no
Z = 2 ***** Helium *****													
** He-3 **													
	2.9901	endl85	LLNL	<1985	0.0	2481	182	20.0	yes	no	no	no	no
	2.9901	endl92	LLNL	<1992	300.0	1477	151	30.0	yes	no	no	no	no
	2.9901	rmccs	B-V.0	1971	293.6	2320	229	20.0	no	no	no	no	no
	2.9901	drmccs	B-V.0	1971	293.6	2612	263	20.0	no	no	no	no	no
	2.9890	endf60	B-VI.1	1990	293.6	2834	342	20.0	no	no	no	no	no
** He-4 **													
	3.9682	endl85	LLNL	<1985	0.0	1442	78	20.0	no	no	no	no	no
	3.9682	endl92	LLNL	<1992	300.0	1332	49	30.0	no	no	no	no	no
	4.0015	rmccs	B-V.0	1973	293.6	3061	345	20.0	no	no	no	no	no
	4.0015	drmccs	B-V.0	1973	293.6	2651	263	20.0	no	no	no	no	no
	4.0015	endf60	B-VI.0	1973	293.6	2971	327	20.0	no	no	no	no	no
Z = 3 ***** Lithium *****													
** Li-6 **													
	5.9635	endl92	LLNL	<1992	300.0	7805	294	30.0	yes	no	no	no	no
	5.9634	rmccs	B-V.0	1977	293.6	9932	373	20.0	yes	no	no	no	no
	5.9634	drmccs	B-V.0	1977	293.6	8716	263	20.0	yes	no	no	no	no
	5.9634	endf60	B-VI.1	1989	293.6	12385	498	20.0	yes	no	no	no	no
** Li-7 **													
	6.9557	endl92	LLNL	<1992	300.0	5834	141	30.0	yes	no	no	no	no
	6.9557	endf5p	B-V.0	1972	293.6	4864	343	20.0	yes	no	no	no	no
	6.9557	dre5	B-V.0	1972	293.6	4935	263	20.0	yes	no	no	no	no
	6.9557	rmccs	B-V.2	1979	293.6	13171	328	20.0	yes	no	no	no	no
	6.9557	drmccs	B-V.2	1979	293.6	12647	263	20.0	yes	no	no	no	no
	6.9557	endf60	B-VI.0	1988	293.6	14567	387	20.0	yes	no	no	no	no
Z = 4 ***** Beryllium *****													
** Be-7 **													
	6.9567	endl85	LLNL	<1985	0.0	1834	180	20.0	no	no	no	no	no
	6.9567	endl92	LLNL	<1992	300.0	1544	127	30.0	yes	no	no	no	no
** Be-9 **													
	8.9348	100xs[3]	T-2:X-5	1989	300.0	28964	316	100.0	yes	no	no	no	no
	8.9348	rmccs	B-V.0	1976	293.6	8886	329	20.0	yes	no	no	no	no
	8.9348	drmccs	B-V.0	1976	293.6	8756	263	20.0	yes	no	no	no	no
	8.9348	endf60	B-VI.0	1986	293.6	64410	276	20.0	yes	no	no	no	no
Z = 5 ***** Boron *****													

**APPENDIX G**  
**MCNP NEUTRON CROSS-SECTION LIBRARIES**

**TABLE G-2 (Cont.)**  
**Continuous-Energy and Discrete Neutron Data Libraries Maintained by X-5**

ZAID	Library		Eval Date	Temp (°K)	Length words	NE	$E_{max}$			$\bar{U}$	CP	DN	UR
	AWR	Name					Source	MeV	GPD				
** B-10 **													
5010.42c	9.9269	endl92	LLNL	<1992	300.0	4733	175	30.0	yes	no	no	no	no
5010.50c	9.9269	rmccs	B-V.0	1977	293.6	20200	514	20.0	yes	no	no	no	no
5010.50d	9.9269	drmcchs	B-V.0	1977	293.6	12322	263	20.0	yes	no	no	no	no
5010.53c	9.9269	endf5mt[1]	B-V.0	1977	587.2	23676	700	20.0	yes	no	no	no	no
5010.60c	9.9269	endf60	B-VI.1	1989	293.6	27957	673	20.0	yes	no	no	no	no
** B-11 **													
5011.35c	10.9147	endl85	LLNL	<1985	0.0	4289	247	20.0	yes	no	no	no	no
5011.42c	10.9147	endl92	LLNL	<1992	300.0	4285	244	30.0	yes	no	no	no	no
5011.50c	10.9150	endf5p	B-V.0	1974	293.6	4344	487	20.0	no	no	no	no	no
5011.50d	10.9150	dre5	B-V.0	1974	293.6	2812	263	20.0	no	no	no	no	no
5011.55c	10.9150	rmccsa	B-V.0:T-2	1971[4]	293.6	12254	860	20.0	yes	no	no	no	no
5011.55d	10.9150	drmcchs	B-V.0:T-2	1971[4]	293.6	7106	263	20.0	yes	no	no	no	no
5011.56c	10.9147	newxs	T-2	1986	293.6	56929	1762	20.0	yes	no	no	no	no
5011.56d	10.9147	newxsd	T-2	1986	293.6	17348	263	20.0	yes	no	no	no	no
5011.60c	10.9147	endf60	B-VI.0	1989	293.6	108351	2969	20.0	yes	no	no	no	no
Z = 6 ***** Carbon *****													
** C-nat **													
6000.50c	11.8969	rmccs	B-V.0	1977	293.6	23326	875	20.0	yes	no	no	no	no
6000.50d	11.8969	drmcchs	B-V.0	1977	293.6	16844	263	20.0	yes	no	no	no	no
6000.60c	11.8980	endf60	B-VI.1	1989	293.6	22422	978	32.0	yes	no	no	no	no
** C-12 **													
6012.21c	11.8969	100xs[3]	T-2:X-5	1989	300.0	28809	919	100.0	yes	no	no	no	no
6012.35c	11.8969	endl85	LLNL	<1985	0.0	5154	225	20.0	yes	no	no	no	no
6012.42c	11.8969	endl92	LLNL	<1992	300.0	6229	191	30.0	yes	no	no	no	no
6012.50c	11.8969	rmccs[5]	B-V.0	1977	293.6	23326	875	20.0	yes	no	no	no	no
6012.50d	11.8969	drmcchs[5]	B-V.0	1977	293.6	16844	263	20.0	yes	no	no	no	no
** C-13 **													
6013.35c	12.8916	endl85	LLNL	<1985	0.0	4886	395	20.0	yes	no	no	no	no
6013.42c	12.8916	endl92	LLNL	<1992	300.0	5993	429	30.0	yes	no	no	no	no
Z = 7 ***** Nitrogen *****													
** N-14 **													
7014.42c	13.8828	endl92	LLNL	<1992	300.0	20528	770	30.0	yes	no	no	no	no
7014.50c	13.8830	rmccs	B-V.0	1973	293.6	45457	1196	20.0	yes	no	no	no	no
7014.50d	13.8830	drmcchs	B-V.0	1973	293.6	26793	263	20.0	yes	no	no	no	no
7014.60c	13.8828	endf60	T-2	1992	293.6	60397	1379	20.0	yes	no	no	no	no
** N-15 **													
7015.42c	14.8713	endl92	LLNL	<1992	300.0	22590	352	30.0	yes	no	no	no	no
7015.55c	14.8710	rmccsa	T-2	1983	293.6	20920	744	20.0	yes	no	no	no	no
7015.55d	14.8710	drmcchs	T-2	1983	293.6	15273	263	20.0	yes	no	no	no	no
7015.60c	14.8710	endf60	B-VI.0	1993	293.6	24410	653	20.0	yes	no	no	no	no
Z = 8 ***** Oxygen *****													
** O-16 **													
8016.21c	15.8575	100xs[3]	T-2:X-5	1989	300.0	45016	1427	100.0	yes	no	no	no	no
8016.35c	15.8575	endl85	LLNL	<1985	0.0	10357	465	20.0	yes	no	no	no	no
8016.42c	15.8575	endl92	LLNL	<1992	300.0	9551	337	30.0	yes	no	no	no	no
8016.50c	15.8580	rmccs	B-V.0	1972	293.6	37942	1391	20.0	yes	no	no	no	no
8016.50d	15.8580	drmcchs	B-V.0	1972	293.6	20455	263	20.0	yes	no	no	no	no
8016.53c	15.8580	endf5mt[1]	B-V.0	1972	587.2	37989	1398	20.0	yes	no	no	no	no
8016.54c	15.8580	endf5mt[1]	B-V.0	1972	880.8	38017	1402	20.0	yes	no	no	no	no
8016.60c	15.8532	endf60	B-VI.0	1990	293.6	58253	1609	20.0	yes	no	no	no	no
** O-17 **													
8017.60c	16.8531	endf60	B-VI.0	1978	293.6	4200	335	20.0	no	no	no	no	no
Z = 9 ***** Fluorine *****													
** F-19 **													
9019.35c	18.8352	endl85	LLNL	<1985	0.0	31547	1452	20.0	yes	no	no	no	no
9019.42c	18.8352	endl92	LLNL	<1992	300.0	37814	1118	30.0	yes	no	no	no	no
9019.50c	18.8350	endf5p	B-V.0	1976	293.6	44130	1569	20.0	yes	no	no	no	no



**APPENDIX G**  
**MCNP NEUTRON CROSS-SECTION LIBRARIES**

**TABLE G-2 (Cont.)**  
**Continuous-Energy and Discrete Neutron Data Libraries Maintained by X-5**

ZAID	Library		Eval Date	Temp (°K)	Length words	NE	$E_{max}$			$\bar{U}$	CP	DN	UR
	AWR	Name					Source	MeV	GPD				
9019.50d	18.8350	dre5	B-V.0	1976	293.6	23156	263	20.0	yes	no	no	no	no
9019.51c	18.8350	rmccs	B-V.0	1976	293.6	41442	1541	20.0	yes	no	no	no	no
9019.51d	18.8350	drmccs	B-V.0	1976	293.6	23156	263	20.0	yes	no	no	no	no
9019.60c	18.8350	endf60	B-VI.0	1990	300.0	93826	1433	20.0	yes	no	no	no	no
Z = 10 ***** Neon *****													
** Ne-20 **													
10020.42c	19.8207	endl92	LLNL	<1992	300.0	14286	1011	30.0	yes	no	no	no	no
Z = 11 ***** Sodium *****													
** Na-23 **													
11023.35c	22.7923	endl85	LLNL	<1985	0.0	22777	1559	20.0	yes	no	no	no	no
11023.42c	22.7923	endl92	LLNL	<1992	300.0	19309	1163	30.0	yes	no	no	no	no
11023.50c	22.7920	endf5p	B-V.0	1977	293.6	52252	2703	20.0	yes	no	no	no	no
11023.50d	22.7920	dre5	B-V.0	1977	293.6	41665	263	20.0	yes	no	no	no	no
11023.51c	22.7920	rmccs	B-V.0	1977	293.6	48863	2228	20.0	yes	no	no	no	no
11023.51d	22.7920	drmccs	B-V.0	1977	293.6	41665	263	20.0	yes	no	no	no	no
11023.60c	22.7920	endf60	B-VI.1	1977	293.6	50294	2543	20.0	yes	no	no	no	no
Z = 12 ***** Magnesium *****													
** Mg-nat **													
12000.35c	24.0962	endl85	LLNL	<1985	0.0	9686	675	20.0	yes	no	no	no	no
12000.42c	24.0962	endl92	LLNL	<1992	300.0	9288	468	30.0	yes	no	no	no	no
12000.50c	24.0963	endf5u	B-V.0	1978	293.6	56334	2430	20.0	yes	no	no	no	no
12000.50d	24.0963	dre5	B-V.0	1978	293.6	14070	263	20.0	yes	no	no	no	no
12000.51c	24.0963	rmccs	B-V.0	1978	293.6	48917	1928	20.0	yes	no	no	no	no
12000.51d	24.0963	drmccs	B-V.0	1978	293.6	14070	263	20.0	yes	no	no	no	no
12000.60c	24.0963	endf60	B-VI.0	1978	293.6	55776	2525	20.0	yes	no	no	no	no
Z = 13 ***** Aluminum *****													
** Al-27 **													
13027.21c	26.7498	100xs[3]	T-2:X-5	1989	300.0	35022	1473	100.0	yes	no	no	no	no
13027.35c	26.7498	endl85	LLNL	<1985	0.0	36895	2038	20.0	yes	no	no	no	no
13027.42c	26.7498	endl92	LLNL	<1992	300.0	32388	1645	30.0	yes	no	no	no	no
13027.50c	26.7500	rmccs	B-V.0	1973	293.6	54162	2028	20.0	yes	no	no	no	no
13027.50d	26.7500	drmccs	B-V.0	1973	293.6	41947	263	20.0	yes	no	no	no	no
13027.60c	26.7500	endf60	B-VI.0	1973	293.6	55427	2241	20.0	yes	no	no	no	no
Z = 14 ***** Silicon *****													
** Si-nat **													
14000.21c	27.8440	100xs[3]	T-2:X-5	1989	300.0	76399	2883	100.0	yes	no	no	no	no
14000.35c	27.8442	endl85	LLNL	<1985	0.0	19016	1012	20.0	yes	no	no	no	no
14000.42c	27.8442	endl92	LLNL	<1992	300.0	16696	855	30.0	yes	no	no	no	no
14000.50c	27.8440	endf5p	B-V.0	1976	293.6	98609	2440	20.0	yes	no	no	no	no
14000.50d	27.8440	dre5	B-V.0	1976	293.6	69498	263	20.0	yes	no	no	no	no
14000.51c	27.8440	rmccs	B-V.0	1976	293.6	88129	1887	20.0	yes	no	no	no	no
14000.51d	27.8440	drmccs	B-V.0	1976	293.6	69498	263	20.0	yes	no	no	no	no
14000.60c	27.8440	endf60	B-VI.0	1976	293.6	104198	2824	20.0	yes	no	no	no	no
Z = 15 ***** Phosphorus *****													
** P-31 **													
15031.35c	30.7077	endl85	LLNL	<1985	0.0	5875	303	20.0	yes	no	no	no	no
15031.42c	30.7077	endl92	LLNL	<1992	300.0	6805	224	30.0	yes	no	no	no	no
15031.50c	30.7080	endf5u	B-V.0	1977	293.6	5733	326	20.0	yes	no	no	no	no
15031.50d	30.7080	dre5	B-V.0	1977	293.6	5761	263	20.0	yes	no	no	no	no
15031.51c	30.7080	rmccs	B-V.0	1977	293.6	5732	326	20.0	yes	no	no	no	no
15031.51d	30.7080	drmccs	B-V.0	1977	293.6	5761	263	20.0	yes	no	no	no	no
15031.60c	30.7080	endf60	B-VI.0	1977	293.6	6715	297	20.0	yes	no	no	no	no

**APPENDIX G**  
**MCNP NEUTRON CROSS-SECTION LIBRARIES**

**TABLE G-2 (Cont.)**  
**Continuous-Energy and Discrete Neutron Data Libraries Maintained by X-5**

Z	Library	Eval	Temp	Length	$E_{max}$	NE	GPD	$\bar{U}$	CP	DN	UR		
Z	AWR	Name	Source	Date	(°K)	words	MeV						
Z = 16	***** Sulfur *****												
** S-nat **													
16000.60c	31.7882	endf60	B-VI.0	1979	293.6	108683	8382	20.0	yes	no	no	no	no
** S-32 **													
16032.35c	31.6974	endl85	LLNL	<1985	0.0	7054	357	20.0	yes	no	no	no	no
16032.42c	31.6974	endl92	LLNL	<1992	300.0	6623	307	30.0	yes	no	no	no	no
16032.50c	31.6970	endf5u	B-V.0	1977	293.6	6789	363	20.0	yes	no	no	no	no
16032.50d	31.6970	dre5	B-V.0	1977	293.6	6302	263	20.0	yes	no	no	no	no
16032.51c	31.6970	rmccs	B-V.0	1977	293.6	6780	362	20.0	yes	no	no	no	no
16032.51d	31.6970	drmcgs	B-V.0	1977	293.6	6302	263	20.0	yes	no	no	no	no
16032.60c	31.6970	endf60	B-VI.0	1977	293.6	7025	377	20.0	yes	no	no	no	no
Z = 17	***** Chlorine *****												
** Cl-nat **													
17000.35c	35.1484	endl85	LLNL	<1985	0.0	12903	1014	20.0	yes	no	no	no	no
17000.42c	35.1484	endl92	LLNL	<1992	300.0	12012	807	30.0	yes	no	no	no	no
17000.50c	35.1480	endf5p	B-V.0	1967	293.6	23313	1499	20.0	yes	no	no	no	no
17000.50d	35.1480	dre5	B-V.0	1967	293.6	18209	263	20.0	yes	no	no	no	no
17000.51c	35.1480	rmccs	B-V.0	1967	293.6	21084	1375	20.0	yes	no	no	no	no
17000.51d	35.1480	drmcgs	B-V.0	1967	293.6	18209	263	20.0	yes	no	no	no	no
17000.60c	35.1480	endf60	B-VI.0	1967	293.6	24090	1816	20.0	yes	no	no	no	no
Z = 18	***** Argon *****												
** Ar-nat **													
18000.35c	39.6048	rmccsa	LLNL	<1985	0.0	5585	259	20.0	yes	no	no	no	no
18000.35d	39.6048	drmcgs	LLNL	<1985	0.0	14703	263	20.0	yes	no	no	no	no
18000.42c	39.6048	endl92	LLNL	<1992	300.0	5580	152	30.0	yes	no	no	no	no
18000.59c	39.6048	misc5xs[6,7]	T-2	1982	293.6	3473	252	20.0	yes	no	no	no	no
Z = 19	***** Potassium *****												
** K-nat **													
19000.35c	38.7624	endl85	LLNL	<1985	0.0	11130	714	20.0	yes	no	no	no	no
19000.42c	38.7624	endl92	LLNL	<1992	300.0	11060	544	30.0	yes	no	no	no	no
19000.50c	38.7660	endf5u	B-V.0	1974	293.6	22051	1243	20.0	yes	no	no	no	no
19000.50d	38.7660	dre5	B-V.0	1974	293.6	23137	263	20.0	yes	no	no	no	no
19000.51c	38.7660	rmccs	B-V.0	1974	293.6	18798	1046	20.0	yes	no	no	no	no
19000.51d	38.7660	drmcgs	B-V.0	1974	293.6	23137	263	20.0	yes	no	no	no	no
19000.60c	38.7660	endf60	B-VI.0	1974	293.6	24482	1767	20.0	yes	no	no	no	no
Z = 20	***** Calcium *****												
** Ca-nat **													
20000.35c	39.7357	endl85	LLNL	<1985	0.0	12933	974	20.0	yes	no	no	no	no
20000.42c	39.7357	endl92	LLNL	<1992	300.0	13946	1002	30.0	yes	no	no	no	no
20000.50c	39.7360	endf5u	B-V.0	1976	293.6	62624	2394	20.0	yes	no	no	no	no
20000.50d	39.7360	dre5	B-V.0	1976	293.6	29033	263	20.0	yes	no	no	no	no
20000.51c	39.7360	rmccs	B-V.0	1976	293.6	53372	1796	20.0	yes	no	no	no	no
20000.51d	39.7360	drmcgs	B-V.0	1976	293.6	29033	263	20.0	yes	no	no	no	no
20000.60c	39.7360	endf60	B-VI.0	1980	293.6	76468	2704	20.0	yes	no	no	no	no
** Ca-40 **													
20040.21c	39.6193	100xs[3]	T-2:X-5	1989	300.0	53013	2718	100.0	yes	no	no	no	no
Z = 21	***** Scandium *****												
** Sc-45 **													
21045.60c	44.5679	endf60	B-VI.2	1992	293.6	105627	10639	20.0	yes	no	no	no	no
Z = 22	***** Titanium *****												
** Ti-nat **													
22000.35c	47.4885	endl85	LLNL	<1985	0.0	13421	1337	20.0	yes	no	no	no	no
22000.42c	47.4885	endl92	LLNL	<1992	300.0	8979	608	30.0	yes	no	no	no	no

**TABLE G-2 (Cont.)**  
**Continuous-Energy and Discrete Neutron Data Libraries Maintained by X-5**

ZAJD	Library		Eval Date	Temp (°K)	Length words	NE	E <sub>max</sub>			̄U	CP	DN	UR
	AWR	Name					Source	MeV	GPD				
22000.50c	47.4676	endf5u	B-V.0	1977	293.6	54801	4434	20.0	yes	no	no	no	no
22000.50d	47.4676	dre5	B-V.0	1977	293.6	10453	263	20.0	yes	no	no	no	no
22000.51c	47.4676	rmccs	B-V.0	1977	293.6	31832	1934	20.0	yes	no	no	no	no
22000.51d	47.4676	drmccs	B-V.0	1977	293.6	10453	263	20.0	yes	no	no	no	no
22000.60c	47.4676	endf60	B-VI.0	1977	293.6	76454	7761	20.0	yes	no	no	no	no
Z = 23 ***** Vanadium *****													
** V-nat **													
23000.50c	50.5040	endf5u	B-V.0	1977	293.6	38312	2265	20.0	yes	no	no	no	no
23000.50d	50.5040	dre5	B-V.0	1977	293.6	8868	263	20.0	yes	no	no	no	no
23000.51c	50.5040	rmccs	B-V.0	1977	293.6	34110	1899	20.0	yes	no	no	no	no
23000.51d	50.5040	drmccs	B-V.0	1977	293.6	8868	263	20.0	yes	no	no	no	no
23000.60c	50.5040	endf60	B-VI.0	1988	293.6	167334	8957	20.0	yes	no	no	no	no
** V-51 **													
23051.42c	50.5063	endl92	LLNL	<1992	300.0	94082	5988	30.0	yes	no	no	no	no
Z = 24 ***** Chromium *****													
** Cr-nat **													
24000.35c	51.5493	endl85	LLNL	<1985	0.0	9218	358	20.0	yes	no	no	no	no
24000.42c	51.5493	endl92	LLNL	<1992	300.0	12573	377	30.0	yes	no	no	no	no
24000.50c	51.5490	rmccs	B-V.0	1977	293.6	134454	11050	20.0	yes	no	no	no	no
24000.50d	51.5490	drmccs	B-V.0	1977	293.6	30714	263	20.0	yes	no	no	no	no
** Cr-50 **													
24050.60c	49.5170	endf60	B-VI.1	1989	293.6	119178	11918	20.0	yes	no	no	no	no
** Cr-52 **													
24052.60c	51.4940	endf60	B-VI.1	1989	293.6	117680	10679	20.0	yes	no	no	no	no
** Cr-53 **													
24053.60c	52.4860	endf60	B-VI.1	1989	293.6	114982	10073	20.0	yes	no	no	no	no
** Cr-54 **													
24054.60c	53.4760	endf60	B-VI.1	1989	293.6	98510	9699	20.0	yes	no	no	no	no
Z = 25 ***** Manganese *****													
** Mn-55 **													
25055.35c	54.4661	endl85	LLNL	<1985	0.0	7493	446	20.0	yes	no	no	no	no
25055.42c	54.4661	endl92	LLNL	<1992	300.0	10262	460	30.0	yes	no	no	no	no
25055.50c	54.4661	endf5u	B-V.0	1977	293.6	105093	12525	20.0	yes	no	no	no	no
25055.50d	54.4661	dre5	B-V.0	1977	293.6	9681	263	20.0	yes	no	no	no	no
25055.51c	54.4661	rmccs	B-V.0	1977	293.6	25727	1578	20.0	yes	no	no	no	no
25055.51d	54.4661	drmccs	B-V.0	1977	293.6	9681	263	20.0	yes	no	no	no	no
25055.60c	54.4661	endf60	B-VI.0	1988	293.6	184269	8207	20.0	yes	no	no	no	no
Z = 26 ***** Iron *****													
** Fe-nat **													
26000.21c	55.3650	100xs[3]	T-2:X-5	1989	300.0	149855	15598	100.0	yes	no	no	no	no
26000.35c	55.3672	endl85	LLNL	<1985	0.0	30983	2772	20.0	yes	no	no	no	no
26000.42c	55.3672	endl92	LLNL	<1992	300.0	38653	3385	30.0	yes	no	no	no	no
26000.50c	55.3650	endf5p	B-V.0	1978	293.6	115447	10957	20.0	yes	no	no	no	no
26000.50d	55.3650	dre5	B-V.0	1978	293.6	33896	263	20.0	yes	no	no	no	no
26000.55c	55.3650	rmccs	T-2	1986	293.6	178392	6899	20.0	yes	no	no	no	no
26000.55d	55.3650	drmccs	T-2	1986	293.6	72632	263	20.0	yes	no	no	no	no
** Fe-54 **													
26054.60c	53.4760	endf60	B-VI.1	1989	293.6	121631	10701	20.0	yes	no	no	no	no
** Fe-56 **													
26056.60c	55.4540	endf60	B-VI.1	1989	293.6	174517	11618	20.0	yes	no	no	no	no
** Fe-57 **													
26057.60c	56.4460	endf60	B-VI.1	1989	293.6	133995	7606	20.0	yes	no	no	no	no
** Fe-58 **													
26058.60c	57.4360	endf60	B-VI.1	1989	293.6	93450	6788	20.0	yes	no	no	no	no
Z = 27 ***** Cobalt *****													
** Co-59 **													

**APPENDIX G**  
**MCNP NEUTRON CROSS-SECTION LIBRARIES**

**TABLE G-2 (Cont.)**  
**Continuous-Energy and Discrete Neutron Data Libraries Maintained by X-5**

ZAIID	AWR	Library		Eval Date	Temp (°K)	Length words	NE	$E_{max}$			$\bar{U}$	CP	DN	UR
		Name	Source					MeV	GPD					
27059.35c	58.4269	endl85	LLNL	<1985	0.0	38958	4177	20.0	yes	no	no	no	no	
27059.42c	58.4269	endl92	LLNL	<1992	300.0	119231	13098	30.0	yes	no	no	no	no	
27059.50c	58.4269	endf5u	B-V.0	1977	293.6	117075	14502	20.0	yes	no	no	no	no	
27059.50d	58.4269	dre5	B-V.0	1977	293.6	11769	263	20.0	yes	no	no	no	no	
27059.51c	58.4269	rmccs	B-V.0	1977	293.6	28355	1928	20.0	yes	no	no	no	no	
27059.51d	58.4269	drmccs	B-V.0	1977	293.6	11769	263	20.0	yes	no	no	no	no	
27059.60c	58.4269	endf60	B-VI.2	1992	293.6	186618	11838	20.0	yes	no	no	no	no	
Z = 28 ***** Nickel *****														
** Ni-nat **														
28000.42c	58.1957	endl92	LLNL	<1992	300.0	44833	3116	30.0	yes	no	no	no	no	
28000.50c	58.1826	rmccs	B-V.0	1977	293.6	139913	8927	20.0	yes	no	no	no	no	
28000.50d	58.1826	drmccs	B-V.0	1977	293.6	21998	263	20.0	yes	no	no	no	no	
** Ni-58 **														
28058.35c	57.4376	endl85	LLNL	<1985	0.0	42744	4806	20.0	yes	no	no	no	no	
28058.42c	57.4376	endl92	LLNL	<1992	300.0	38930	4914	30.0	yes	no	no	no	no	
28058.60c	57.4380	endf60	B-VI.1	1989	293.6	172069	16445	20.0	yes	no	no	no	no	
** Ni-60 **														
28060.60c	59.4160	endf60	B-VI.1	1991	293.6	110885	10055	20.0	yes	no	no	no	no	
** Ni-61 **														
28061.60c	60.4080	endf60	B-VI.1	1989	293.6	93801	5882	20.0	yes	no	no	no	no	
** Ni-62 **														
28062.60c	61.3960	endf60	B-VI.1	1989	293.6	82085	7230	20.0	yes	no	no	no	no	
** Ni-64 **														
28064.60c	63.3790	endf60	B-VI.1	1989	293.6	66656	6144	20.0	yes	no	no	no	no	
Z = 29 ***** Copper *****														
** Cu-nat **														
29000.35c	63.0001	endl85	LLNL	<1985	0.0	7039	293	20.0	yes	no	no	no	no	
29000.50c	63.5460	rmccs	B-V.0	1978	293.6	51850	3435	20.0	yes	no	no	no	no	
29000.50d	63.5460	drmccs	B-V.0	1978	293.6	12777	263	20.0	yes	no	no	no	no	
** Cu-63 **														
29063.60c	62.3890	endf60	B-VI.2	1989	293.6	119097	11309	20.0	yes	no	no	no	no	
** Cu-65 **														
29065.60c	64.3700	endf60	B-VI.2	1989	293.6	118385	11801	20.0	yes	no	no	no	no	
Z = 30 ***** Zinc *****														
** Zn-nat **														
30000.40c	64.8183	endl92	LLNL	<1992	300.0	271897	33027	30.0	yes	no	no	no	no	
30000.42c	64.8183	endl92	LLNL:X-5	<1992	300.0	271897	33027	30.0	yes	no	no	no	no	
Z = 31 ***** Gallium *****														
** Ga-nat **														
31000.35c	69.1211	endl85	LLNL	<1985	0.0	7509	469	20.0	yes	no	no	no	no	
31000.42c	69.1211	endl92	LLNL	<1992	300.0	6311	219	30.0	yes	no	no	no	no	
31000.50c	69.1211	rmccs	B-V.0	1980	293.6	7928	511	20.0	yes	no	no	no	no	
31000.50d	69.1211	drmccs	B-V.0	1980	293.6	6211	263	20.0	yes	no	no	no	no	
31000.60c	69.1211	endf60	B-VI.0	1980	293.6	9228	566	20.0	yes	no	no	no	no	
Z = 33 ***** Arsenic *****														
** As-74 **														
33074.35c	73.2889	endl85	LLNL	<1985	0.0	50881	6424	20.0	yes	no	no	no	no	
33074.42c	73.2889	endl92	LLNL	<1992	300.0	55752	6851	30.0	yes	no	no	no	no	
** As-75 **														
33075.35c	74.2780	rmccsa	B-V.0	1974	0.0	50931	6421	20.0	yes	no	no	no	no	
33075.35d	74.2780	drmccs	B-V.0	1974	0.0	8480	263	20.0	yes	no	no	no	no	
33075.42c	74.2780	endl92	LLNL	<1992	300.0	56915	6840	30.0	yes	no	no	no	no	
Z = 35 ***** Bromine *****														
** Br-79 **														

**APPENDIX G**  
**MCNP NEUTRON CROSS-SECTION LIBRARIES**

**TABLE G-2 (Cont.)**  
**Continuous-Energy and Discrete Neutron Data Libraries Maintained by X-5**

ZAID	AWR	Library Name	Source	Eval Date	Temp (°K)	Length words	NE	E <sub>max</sub> MeV	GPD	$\bar{U}$	CP	DN	UR
35079.55c	78.2404	misc5xs[6,8]	T-2	1982	293.6	10431	1589	20.0	no	no	no	no	no
** Br-81 **													
35081.55c	80.2212	misc5xs[6,8]	T-2	1982	293.6	5342	831	20.0	no	no	no	no	no
Z = 36 ***** Krypton *****													
** Kr-78 **													
36078.50c	77.2510	rmccsa	B-V.0	1978	293.6	9057	939	20.0	no	no	no	no	no
36078.50d	77.2510	drmccs	B-V.0	1978	293.6	4358	263	20.0	no	no	no	no	no
** Kr-80 **													
36080.50c	79.2298	rmccsa	B-V.0	1978	293.6	10165	1108	20.0	no	no	no	no	no
36080.50d	79.2298	drmccs	B-V.0	1978	293.6	4276	263	20.0	no	no	no	no	no
** Kr-82 **													
36082.50c	81.2098	rmccsa	B-V.0	1978	293.6	7220	586	20.0	no	no	no	no	no
36082.50d	81.2098	drmccs	B-V.0	1978	293.6	4266	263	20.0	no	no	no	no	no
36082.59c	81.2098	misc5xs[6,7]	T-2	1982	293.6	7010	499	20.0	yes	no	no	no	no
** Kr-83 **													
36083.50c	82.2018	rmccsa	B-V.0	1978	293.6	8078	811	20.0	no	no	no	no	no
36083.50d	82.2018	drmccs	B-V.0	1978	293.6	4359	263	20.0	no	no	no	no	no
36083.59c	82.2018	misc5xs[6,7]	T-2	1982	293.6	8069	704	20.0	yes	no	no	no	no
** Kr-84 **													
36084.50c	83.1906	rmccsa	B-V.0	1978	293.6	9364	944	20.0	no	no	no	no	no
36084.50d	83.1906	drmccs	B-V.0	1978	293.6	4463	263	20.0	no	no	no	no	no
36084.59c	83.1906	misc5xs[6,7]	T-2	1982	293.6	10370	954	20.0	yes	no	no	no	no
** Kr-86 **													
36086.50c	85.1726	rmccsa	B-V.0	1975	293.6	10416	741	20.0	no	no	no	no	no
36086.50d	85.1726	drmccs	B-V.0	1975	293.6	4301	263	20.0	no	no	no	no	no
36086.59c	85.1726	misc5xs[6,7]	T-2	1982	293.6	8740	551	20.0	yes	no	no	no	no
Z = 37 ***** Rubidium *****													
** Rb-85 **													
37085.55c	84.1824	misc5xs[6,8]	T-2	1982	293.6	27304	4507	20.0	no	no	no	no	no
** Rb-87 **													
37087.55c	86.1626	misc5xs[6,8]	T-2	1982	293.6	8409	1373	20.0	no	no	no	no	no
Z = 39 ***** Yttrium *****													
** Y-88 **													
39088.35c	87.1543	endl85	LLNL	<1985	0.0	11299	272	20.0	yes	no	no	no	no
39088.42c	87.1543	endl92	LLNL	<1992	300.0	11682	181	30.0	yes	no	no	no	no
** Y-89 **													
39089.35c	88.1421	misc5xs[6]	LLNL	<1985	0.0	49885	6154	20.0	yes	no	no	no	no
39089.42c	88.1421	endl92	LLNL	<1992	300.0	69315	8771	30.0	yes	no	no	no	no
39089.50c	88.1421	endf5u	B-V.0[9]	1985	293.6	18631	3029	20.0	no	no	no	no	no
39089.50d	88.1421	dre5	B-V.0[9]	1985	293.6	2311	263	20.0	no	no	no	no	no
39089.60c	88.1420	endf60	B-VI.0	1986	293.6	86556	9567	20.0	yes	no	no	no	no
Z = 40 ***** Zirconium *****													
** Zr-nat **													
40000.35c	90.4364	endl85	LLNL	<1985	0.0	14738	1292	20.0	yes	no	no	no	no
40000.42c	90.4364	endl92	LLNL	<1992	300.0	131855	17909	30.0	yes	no	no	no	no
40000.56c	90.4360	misc5xs[6,10]	B-V:X-5	1976	300.0	52064	7944	20.0	no	no	no	no	no
40000.56d	90.4360	misc5xs[6,10]	B-V:X-5	1976	300.0	5400	263	20.0	no	no	no	no	no
40000.57c	90.4360	misc5xs[6,10]	B-V:X-5	1976	300.0	16816	2116	20.0	no	no	no	no	no
40000.57d	90.4360	misc5xs[6,10]	B-V:X-5	1976	300.0	5400	263	20.0	no	no	no	no	no
40000.58c	90.4360	misc5xs[6,10]	B-V:X-5	1976	587.2	57528	8777	20.0	no	no	no	no	no
40000.60c	90.4360	endf60	B-VI.1	1976[10]	293.6	66035	10298	20.0	no	no	no	no	no
** Zr-93 **													
40093.50c	92.1083	kidman	B-V.0	1974	293.6	2579	236	20.0	no	no	no	no	no
Z = 41 ***** Niobium *****													
** Nb-93 **													
41093.35c	92.1083	endl85	LLNL	<1985	0.0	50441	6095	20.0	yes	no	no	no	no

**APPENDIX G**  
**MCNP NEUTRON CROSS-SECTION LIBRARIES**

**TABLE G-2 (Cont.)**  
**Continuous-Energy and Discrete Neutron Data Libraries Maintained by X-5**

Z AID	AWR	Library		Eval Date	Temp (°K)	Length words	NE	E <sub>max</sub>		Ū	CP	DN	UR
		Name	Source					MeV	GPD				
41093.42c	92.1083	endl92	LLNL	<1992	300.0	73324	9277	30.0	yes	no	no	no	no
41093.50c	92.1051	endf5p	B-V.0	1974	293.6	128960	17279	20.0	yes	no	no	no	no
41093.50d	92.1051	dre5	B-V.0	1974	293.6	10332	263	20.0	yes	no	no	no	no
41093.51c	92.1051	rmccs	B-V.0	1974	293.6	14675	963	20.0	yes	no	no	no	no
41093.51d	92.1051	drmcsc	B-V.0	1974	293.6	10332	263	20.0	yes	no	no	no	no
41093.60c	92.1051	endf60	B-VI.1	1990	293.6	110269	10678	20.0	yes	no	no	no	no
Z = 42 ***** Molybdenum *****													
** Mo-nat **													
42000.35c	95.1158	endl85	LLNL	<1985	0.0	8628	573	20.0	yes	no	no	no	no
42000.42c	95.1158	endl92	LLNL	<1992	300.0	9293	442	30.0	yes	no	no	no	no
42000.50c	95.1160	endf5u	B-V.0	1979	293.6	35634	4260	20.0	yes	no	no	no	no
42000.50d	95.1160	dre5	B-V.0	1979	293.6	7754	263	20.0	yes	no	no	no	no
42000.51c	95.1160	rmccs	B-V.0	1979	293.6	10139	618	20.0	yes	no	no	no	no
42000.51d	95.1160	drmcsc	B-V.0	1979	293.6	7754	263	20.0	yes	no	no	no	no
42000.60c	95.1160	endf60	B-VI.0	1979	293.6	45573	5466	20.0	yes	no	no	no	no
** Mo-95 **													
42095.50c	94.0906	kidman	B-V.0	1980	293.6	15411	2256	20.0	no	no	no	no	no
Z = 43 ***** Technetium *****													
** Tc-99 **													
43099.50c	98.1500	kidman	B-V.0	1978	293.6	12152	1640	20.0	no	no	no	no	no
43099.60c	98.1500	endf60	B-VI.0	1978	293.6	54262	8565	20.0	no	no	no	no	no
Z = 44 ***** Ruthenium *****													
** Ru-101 **													
44101.50c	100.0390	kidman	B-V.0	1980	293.6	5299	543	20.0	no	no	no	no	no
** Ru-103 **													
44103.50c	102.0220	kidman	B-V.0	1974	293.6	3052	235	20.0	no	no	no	no	no
Z = 45 ***** Rhodium *****													
** Rh-103 **													
45103.50c	102.0210	rmccsa	B-V.0	1978	293.6	18870	2608	20.0	no	no	no	no	no
45103.50d	102.0210	drmcsc	B-V.0	1974	293.6	4663	263	20.0	no	no	no	no	no
** Rh-105 **													
45105.50c	104.0050	kidman	B-V.0	1974	293.6	1591	213	20.0	no	no	no	no	no
Z = 45 ***** Average fission product from Uranium-235 *****													
** U-235 fp **													
45117.90c	115.5446	rmccs	T-2	1982	293.6	10314	399	20.0	yes	no	no	no	no
45117.90d	115.5446	drmcsc	T-2	1982	293.6	9507	263	20.0	yes	no	no	no	no
Z = 46 ***** Palladium *****													
** Pd-105 **													
46105.50c	104.0040	kidman	B-V.0	1980	293.6	4647	505	20.0	no	no	no	no	no
** Pd-108 **													
46108.50c	106.9770	kidman	B-V.0	1980	293.6	4549	555	20.0	no	no	no	no	no
Z = 46 ***** Average fission product from Plutonium-239 *****													
** Pu-239 fp **													
46119.90c	117.5255	rmccs	T-2	1982	293.6	10444	407	20.0	yes	no	no	no	no
46119.90d	117.5255	drmcsc	T-2	1982	293.6	9542	263	20.0	yes	no	no	no	no
Z = 47 ***** Silver *****													
** Ag-nat **													
47000.55c	106.9420	rmccsa	T-2	1984	293.6	29092	2350	20.0	yes	no	no	no	no
47000.55d	106.9420	drmcsc	T-2	1984	293.6	12409	263	20.0	yes	no	no	no	no

**APPENDIX G**  
**MCNP NEUTRON CROSS-SECTION LIBRARIES**

**TABLE G-2 (Cont.)**  
**Continuous-Energy and Discrete Neutron Data Libraries Maintained by X-5**

ZAID	Library		Source	Eval Date	Temp (°K)	Length words	NE	E <sub>max</sub>		̄U	CP	DN	UR
	AWR	Name						MeV	GPD				
<b>** Ag-107 **</b>													
47107.35c	105.9867	endl85	LLNL	<1985	0.0	13134	994	20.0	yes	no	no	no	no
47107.42c	105.9867	endl92	LLNL	<1992	300.0	27108	2885	30.0	yes	no	no	no	no
47107.50c	105.9870	rmccsa	B-V.0	1978	293.6	12111	1669	20.0	no	no	no	no	no
47107.50d	105.9870	drmccs	B-V.0	1978	293.6	4083	263	20.0	no	no	no	no	no
47107.60c	105.9870	endf60	B-VI.0	1983	293.6	64008	10101	20.0	no	no	no	no	no
<b>** Ag-109 **</b>													
47109.35c	107.9692	endl85	LLNL	<1985	0.0	13452	1094	20.0	yes	no	no	no	no
47109.42c	107.9692	endl92	LLNL	<1992	300.0	33603	3796	30.0	yes	no	no	no	no
47109.50c	107.9690	rmccsa	B-V.0	1978	293.6	14585	2120	20.0	no	no	no	no	no
47109.50d	107.9690	drmccs	B-V.0	1978	293.6	3823	263	20.0	no	no	no	no	no
47109.60c	107.9690	endf60	B-VI.0	1983	293.6	76181	11903	20.0	no	no	no	no	no
<b>Z = 48 ***** Cadmium *****</b>													
<b>** Cd-nat **</b>													
48000.35c	111.4443	endl85	LLNL	<1985	0.0	12283	1115	20.0	yes	no	no	no	no
48000.42c	111.4443	endl92	LLNL	<1992	300.0	211537	29369	30.0	yes	no	no	no	no
48000.50c	111.4600	endf5u	B-V.0	1974	293.6	19714	2981	20.0	no	no	no	no	no
48000.50d	111.4600	dre5	B-V.0	1974	293.6	3026	263	20.0	no	no	no	no	no
48000.51c	111.4600	rmccs	B-V.0	1974	293.6	6734	818	20.0	no	no	no	no	no
48000.51d	111.4600	drmccs	B-V.0	1974	293.6	3026	263	20.0	no	no	no	no	no
<b>Z = 49 ***** Indium *****</b>													
<b>** In-nat **</b>													
49000.42c	113.8336	endl92	LLNL	<1992	300.0	65498	7870	30.0	yes	no	no	no	no
49000.60c	113.8340	endf60	B-VI.0	1990	293.6	93662	10116	20.0	yes	no	no	no	no
<b>Z = 49-50 ***** Fission products *****</b>													
<b>** Ave fp **</b>													
49120.42c	116.4906	endl92fp[11]	LLNL	<1992	300.0	12755	164	30.0	yes	no	no	no	no
49125.42c	116.4906	endl92fp[11]	LLNL	<1992	300.0	9142	119	30.0	yes	no	no	no	no
50120.35c	116.4906	rmccs	LLNL	<1985	0.0	8366	232	20.0	yes	no	no	no	no
50120.35d	116.4906	drmccs	LLNL	<1985	0.0	8963	263	20.0	yes	no	no	no	no
<b>Z = 50 ***** Tin *****</b>													
<b>** Sn-nat **</b>													
50000.35c	117.6704	endl85	LLNL	<1985	0.0	5970	205	20.0	yes	no	no	no	no
50000.40c	117.6704	endl92	LLNL	<1992	300.0	248212	34612	30.0	yes	no	no	no	no
50000.42c	117.6704	endl92	LLNL:X-5	<1992	300.0	248212	34612	30.0	yes	no	no	no	no
<b>Z = 51 ***** Antimony *****</b>													
<b>** Sb-nat **</b>													
51000.42c	120.7041	endl92	LLNL	<1992	300.0	95953	10721	30.0	yes	no	no	no	no
<b>Z = 53 ***** Iodine *****</b>													
<b>** I-127 **</b>													
53127.42c	125.8143	endl92	LLNL	<1992	300.0	76321	10	30.0	yes	no	no	no	no
53127.55c	125.8140	misc5xs[6,8]	T-2	1982	293.6	59725	9423	20.0	no	no	no	no	no
53127.60c	125.8143	endf60[12]	T-2	1991	293.6	399760	7888	30.0	yes	no	no	no	no
<b>** I-129 **</b>													
53129.60c	127.7980	endf60	B-VI.0	1980	293.6	8792	1237	20.0	no	no	no	no	no
<b>** I-135 **</b>													
53135.50c	133.7510	kidman	B-V.0	1974	293.6	1232	194	20.0	no	no	no	no	no
<b>Z = 54 ***** Xenon *****</b>													
<b>** Xe-nat **</b>													
54000.35c	130.1721	endl85	LLNL	<1985	0.0	41432	5228	20.0	yes	no	no	no	no
54000.42c	130.1721	endl92	LLNL	<1992	300.0	43411	5173	30.0	yes	no	no	no	no

**APPENDIX G**  
**MCNP NEUTRON CROSS-SECTION LIBRARIES**

**TABLE G-2 (Cont.)**  
**Continuous-Energy and Discrete Neutron Data Libraries Maintained by X-5**

Z	ZAIID	AWR	Library		Eval Date	Temp (°K)	Length words	NE	$E_{max}$			$\bar{v}$	CP	DN	UR	
			Name	Source					MeV	GPD						
	** Xe-131 **															
	54131.50c	129.7810	kidman	B-V.0	1978	293.6	22572	3376	20.0	no	no	no	no	no		
	** Xe-134 **															
	54134.35c	132.7551	endl85	LLNL	<1985	0.0	7463	359	20.0	yes	no	no	no	no		
	54134.42c	132.7551	endl92	LLNL	<1992	300.0	8033	192	30.0	yes	no	no	no	no		
	** Xe-135 **															
	54135.50c	133.7480	endf5mt[1]	B-V	1975	293.6	5529	704	20.0	no	no	no	no	no		
	54135.53c	133.7480	endf5mt[1]	B-V	1975	587.2	5541	706	20.0	no	no	no	no	no		
	54135.54c	133.7480	endf5mt[1]	B-V	1975	880.8	5577	712	20.0	no	no	no	no	no		
Z = 55	***** Cesium *****															
	** Cs-133 **															
	55133.50c	131.7640	kidman	B-V.0	1978	293.6	26713	4142	20.0	no	no	no	no	no		
	55133.55c	131.7640	misc5xs[6,8]	T-2	1982	293.6	67893	11025	20.0	no	no	no	no	no		
	55133.60c	131.7640	endf60	B-VI.0	1978	293.6	54723	8788	20.0	no	no	no	no	no		
	** Cs-134 **															
	55134.60c	132.7570	endf60	B-VI.0	1988	293.6	10227	1602	20.0	no	no	no	no	no		
	** Cs-135 **															
	55135.50c	133.7470	kidman	B-V.0	1974	293.6	1903	199	20.0	no	no	no	no	no		
	55135.60c	133.7470	endf60	B-VI.0	1974	293.6	3120	388	20.0	no	no	no	no	no		
	** Cs-136 **															
	55136.60c	134.7400	endf60	B-VI.0	1974	293.6	10574	1748	20.0	no	no	no	no	no		
	** Cs-137 **															
	55137.60c	135.7310	endf60	B-VI.0	1974	293.6	2925	369	20.0	no	no	no	no	no		
Z = 56	***** Barium *****															
	** Ba-138 **															
	56138.35c	136.7206	endl85	LLNL	<1985	0.0	5985	262	20.0	yes	no	no	no	no		
	56138.50c	136.7150	rmccs	B-V.0	1978	293.6	6018	292	20.0	yes	no	no	no	no		
	56138.50d	136.7150	drmc6	B-V.0	1978	293.6	6320	263	20.0	yes	no	no	no	no		
	56138.60c	136.7150	endf60	B-VI.0	1978	293.6	7347	267	20.0	yes	no	no	no	no		
Z = 59	***** Praseodymium *****															
	** Pr-141 **															
	59141.50c	139.6970	kidman	B-V.0	1980	293.6	15620	1354	20.0	no	no	no	no	no		
Z = 60	***** Neodymium *****															
	** Nd-143 **															
	60143.50c	141.6820	kidman	B-V.0	1980	293.6	17216	1701	20.0	no	no	no	no	no		
	** Nd-145 **															
	60145.50c	143.6680	kidman	B-V.0	1980	293.6	38473	3985	20.0	no	no	no	no	no		
	** Nd-147 **															
	60147.50c	145.6540	kidman	B-V.0	1979	293.6	1816	251	20.0	no	no	no	no	no		
	** Nd-148 **															
	60148.50c	146.6460	kidman	B-V.0	1980	293.6	10867	1054	20.0	no	no	no	no	no		
Z = 61	***** Promethium *****															
	** Pm-147 **															
	61147.50c	145.6530	kidman	B-V.0	1980	293.6	9152	825	20.0	no	no	no	no	no		
	** Pm-148 **															
	61148.50c	146.6470	kidman	B-V.0	1979	293.6	1643	257	20.0	no	no	no	no	no		
	** Pm-149 **															
	61149.50c	147.6390	kidman	B-V.0	1979	293.6	2069	238	20.0	no	no	no	no	no		
Z = 62	***** Samarium *****															
	** Sm-147 **															
	62147.50c	145.6530	kidman	B-V.0	1980	293.6	33773	2885	20.0	no	no	no	no	no		
	** Sm-149 **															
	62149.49c	147.6380	ures	B-VI.0	1978	300.0	57787	7392	20.0	no	no	no	no	yes		
	62149.50c	147.6380	endf5u	B-V.0	1978	293.6	15662	2008	20.0	no	no	no	no	no		



**APPENDIX G**  
**MCNP NEUTRON CROSS-SECTION LIBRARIES**

**TABLE G-2 (Cont.)**  
**Continuous-Energy and Discrete Neutron Data Libraries Maintained by X-5**

ZAIID	AWR	Library		Eval Date	Temp (°K)	Length words	NE	$E_{max}$			$\bar{U}$	CP	DN	UR
		Name	Source					MeV	GPD					
62149.50d	147.6380		dre5	B-V.0	1978	293.6	4429	263	20.0	no	no	no	no	no
** Sm-150 **														
62150.49c	148.6290		ures	B-VI.2	1992	300.0	60992	8183	20.0	no	no	no	no	yes
62150.50c	148.6290		kidman	B-V.0	1974	293.6	9345	1329	20.0	no	no	no	no	no
** Sm-151 **														
62151.50c	149.6230		kidman	B-V.0	1980	293.6	7303	605	20.0	no	no	no	no	no
** Sm-152 **														
62152.49c	150.6150		ures	B-VI.2	1992	300.0	203407	19737	20.0	no	no	no	no	yes
62152.50c	150.6150		kidman	B-V.0	1980	293.6	41252	4298	20.0	no	no	no	no	no
Z = 63 ***** Europium *****														
** Eu-nat **														
63000.35c	150.6546		rmccsa	LLNL	<1985	0.0	6926	364	20.0	yes	no	no	no	no
63000.35d	150.6546		drmccs	LLNL	<1985	0.0	6654	263	20.0	yes	no	no	no	no
63000.42c	150.6546		endf92	LLNL	<1992	300.0	37421	4498	30.0	yes	no	no	no	no
** Eu-151 **														
63151.49c	149.6230		ures	B-VI.0	1986	300.0	147572	10471	20.0	yes	no	no	no	yes
63151.50c	149.6230		rmccs	B-V.0	1977	293.6	68057	5465	20.0	yes	no	no	no	no
63151.50d	149.6230		drmccs	B-V.0	1977	293.6	10013	263	20.0	yes	no	no	no	no
63151.55c	149.6230		newxs	T-2	1986	293.6	86575	4749	20.0	yes	no	no	no	no
63151.55d	149.6230		newxsd	T-2	1986	293.6	35199	263	20.0	yes	no	no	no	no
63151.60c	149.6230		endf60	B-VI.0	1986	293.6	96099	7394	20.0	yes	no	no	no	no
** Eu-152 **														
63152.49c	150.6200		ures	B-VI.0	1975	300.0	81509	6540	20.0	no	no	no	no	yes
63152.50c	150.6200		endf5u	B-V.0	1975	293.6	49313	4553	20.0	no	no	no	no	no
63152.50d	150.6200		dre5	B-V.0	1975	293.6	5655	263	20.0	no	no	no	no	no
** Eu-153 **														
63153.49c	151.6080		ures	B-VI.0	1986	300.0	129446	8784	20.0	yes	no	no	no	yes
63153.50c	151.6070		rmccs	B-V.0	1978	293.6	55231	4636	20.0	yes	no	no	no	no
63153.50d	151.6070		drmccs	B-V.0	1978	293.6	11244	263	20.0	yes	no	no	no	no
63153.55c	151.6080		newxs	T-2	1986	293.6	72971	4174	20.0	yes	no	no	no	no
63153.55d	151.6080		newxsd	T-2	1986	293.6	36372	263	20.0	yes	no	no	no	no
63153.60c	151.6080		endf60	B-VI.0	1986	293.6	86490	6198	20.0	yes	no	no	no	no
** Eu-154 **														
63154.49c	152.6000		ures	B-VI.0	1975	300.0	72804	6627	20.0	no	no	no	no	yes
63154.50c	152.6000		endf5u	B-V.0	1975	293.6	37008	4030	20.0	no	no	no	no	no
63154.50d	152.6000		dre5	B-V.0	1975	293.6	5458	263	20.0	no	no	no	no	no
** Eu-155 **														
63155.50c	153.5920		kidman	B-V.0	1974	293.6	4532	273	20.0	no	no	no	no	no
Z = 64 ***** Gadolinium *****														
** Gd-nat **														
64000.35c	155.8991		rmccsa	LLNL	<1985	0.0	7878	454	20.0	yes	no	no	no	no
64000.35d	155.8991		drmccs	LLNL	<1985	0.0	6833	263	20.0	yes	no	no	no	no
** Gd-152 **														
64152.50c	150.6150		endf5u	B-V.0	1977	293.6	26251	3285	20.0	no	no	no	no	no
64152.50d	150.6150		dre5	B-V.0	1977	293.6	5899	263	20.0	no	no	no	no	no
64152.55c	150.6150	misc5xs[6,13]		B-V.0:T-2	1986	293.6	32590	3285	20.0	yes	no	no	no	no
64152.60c	150.6150		endf60	B-VI.0	1977	293.6	32760	4391	20.0	no	no	no	no	no
** Gd-154 **														
64154.50c	152.5990		endf5u	B-V.0	1977	293.6	49572	7167	20.0	no	no	no	no	no
64154.50d	152.5990		dre5	B-V.0	1977	293.6	5930	263	20.0	no	no	no	no	no
64154.55c	152.5990	misc5xs[6,13]		B-V.0:T-2	1986	293.6	59814	7167	20.0	yes	no	no	no	no
64154.60c	152.5990		endf60	B-VI.0	1977	293.6	67662	10189	20.0	no	no	no	no	no
** Gd-155 **														
64155.50c	153.5920		endf5u	B-V.0	1977	293.6	44965	6314	20.0	no	no	no	no	no
64155.50d	153.5920		dre5	B-V.0	1977	293.6	6528	263	20.0	no	no	no	no	no
64155.55c	153.5920	misc5xs[6,13]		B-V.0:T-2	1986	293.6	54346	6314	20.0	yes	no	no	no	no
64155.60c	153.5920		endf60	B-VI.0	1977	293.6	61398	9052	20.0	no	no	no	no	no
** Gd-156 **														
64156.50c	154.5830		endf5u	B-V.0	1977	293.6	37371	3964	20.0	no	no	no	no	no
64156.50d	154.5830		dre5	B-V.0	1977	293.6	6175	263	20.0	no	no	no	no	no
64156.55c	154.5830	misc5xs[6,13]		B-V.0:T-2	1986	293.6	44391	3964	20.0	yes	no	no	no	no
64156.60c	154.5830		endf60	B-VI.0	1977	293.6	42885	5281	20.0	no	no	no	no	no

**APPENDIX G**  
**MCNP NEUTRON CROSS-SECTION LIBRARIES**

**TABLE G-2 (Cont.)**  
**Continuous-Energy and Discrete Neutron Data Libraries Maintained by X-5**

ZAID	Library		Source	Eval Date	Temp (°K)	Length words	NE	$E_{max}$		$\bar{U}$	CP	DN	UR
	AWR	Name						MeV	GPD				
** Gd-157 **													
64157.50c	155.5760	endf5u	B-V.0	1977	293.6	38975	5370	20.0	no	no	no	no	no
64157.50d	155.5760	dre5	B-V.0	1977	293.6	6346	263	20.0	no	no	no	no	no
64157.55c	155.5760	misc5xs[6,13]	B-V.0:T-2	1986	293.6	47271	5370	20.0	yes	no	no	no	no
64157.60c	155.5760	endf60	B-VI.0	1977	293.6	56957	8368	20.0	no	no	no	no	no
** Gd-158 **													
64158.50c	156.5670	endf5u	B-V.0	1977	293.6	95876	15000	20.0	no	no	no	no	no
64158.50d	156.5670	dre5	B-V.0	1977	293.6	5811	263	20.0	no	no	no	no	no
64158.55c	156.5670	misc5xs[6,13]	B-V.0:T-2	1986	293.6	113916	15000	20.0	yes	no	no	no	no
64158.60c	156.5670	endf60	B-VI.0	1977	293.6	59210	8909	20.0	no	no	no	no	no
** Gd-160 **													
64160.50c	158.5530	endf5u	B-V.0	1977	293.6	53988	8229	20.0	no	no	no	no	no
64160.50d	158.5530	dre5	B-V.0	1977	293.6	5030	263	20.0	no	no	no	no	no
64160.55c	158.5530	misc5xs[6,13]	B-V.0:T-2	1986	293.6	65261	8229	20.0	yes	no	no	no	no
64160.60c	158.5530	endf60	B-VI.0	1977	293.6	54488	8304	20.0	no	no	no	no	no
Z = 67 ***** Holmium *****													
** Ho-165 **													
67165.35c	163.5135	rmccsa	LLNL	<1985	0.0	54279	7075	20.0	yes	no	no	no	no
67165.35d	163.5135	drmccs	LLNL	<1985	0.0	7019	263	20.0	yes	no	no	no	no
67165.42c	163.5135	endf92	LLNL	<1992	300.0	103467	13884	30.0	yes	no	no	no	no
67165.55c	163.5130	newxs	T-2	1986	293.6	56605	2426	30.0	yes	no	no	no	no
67165.55d	163.5130	newxsd	T-2	1986	293.6	42266	263	20.0	yes	no	no	no	no
67165.60c	163.5130	endf60	B-VI.0	1988	293.6	75307	4688	30.0	yes	no	no	no	no
Z = 69 ***** Thulium *****													
** Tm-169 **													
69169.55c	167.4830	misc5xs[6]	T-2	1986	300.0	47941	4738	20.0	no	no	no	no	no
Z = 72 ***** Hafnium *****													
** Hf-nat **													
72000.35c	176.9567	endf85	LLNL	<1985	0.0	75862	9636	20.0	yes	no	no	no	no
72000.42c	176.9567	endf92	LLNL	<1992	300.0	108989	14113	30.0	yes	no	no	no	no
72000.50c	176.9540	newxs	B-V.0	1976	293.6	52231	8270	20.0	no	no	no	no	no
72000.50d	176.9540	newxsd	B-V.0	1976	293.6	4751	263	20.0	no	no	no	no	no
72000.60c	176.9540	endf60	B-VI.0	1976	293.6	84369	13634	20.0	no	no	no	no	no
Z = 73 ***** Tantalum *****													
** Ta-181 **													
73181.35c	179.3936	endf85	LLNL	<1985	0.0	33547	2812	20.0	yes	no	no	no	no
73181.42c	179.3936	endf92	LLNL	<1992	300.0	47852	4927	30.0	yes	no	no	no	no
73181.50c	179.4000	endf5u	B-V.0	1972	293.6	60740	6341	20.0	yes	no	no	no	no
73181.50d	179.4000	dre5	B-V.0	1972	293.6	16361	263	20.0	yes	no	no	no	no
73181.51c	179.4000	rmccs	B-V.0	1972	293.6	21527	753	20.0	yes	no	no	no	no
73181.51d	179.4000	drmccs	B-V.0	1972	293.6	16361	263	20.0	yes	no	no	no	no
73181.60c	179.4000	endf60	B-VI.0	1972	293.6	91374	10352	20.0	yes	no	no	no	no
** Ta-182 **													
73182.49c	180.3870	ures	B-VI.0	1971	300.0	20850	2463	20.0	no	no	no	no	yes
73182.60c	180.3870	endf60	B-VI.0	1971	293.6	12085	1698	20.0	no	no	no	no	no
Z = 74 ***** Tungsten *****													
** W-nat **													
74000.21c	182.2706	100xs[3]	T-2:X-5	1989	300.0	194513	21386	100.0	yes	no	no	no	no
74000.55c	182.2770	rmccs	B-V.2	1982	293.6	50639	1816	20.0	yes	no	no	no	no
74000.55d	182.2770	drmccs	B-V.2	1982	293.6	34272	263	20.0	yes	no	no	no	no
** W-182 **													
74182.49c	180.3900	ures	B-VI.0	1980	300.0	150072	16495	20.0	yes	no	no	no	yes
74182.50c	180.3900	endf5p	B-V.0	1973	293.6	94367	11128	20.0	yes	no	no	no	no
74182.50d	180.3900	dre5	B-V.0	1973	293.6	17729	263	20.0	yes	no	no	no	no
74182.55c	180.3900	rmccsa	B-V.2	1980	293.6	122290	13865	20.0	yes	no	no	no	no
74182.55d	180.3900	drmccs	B-V.2	1980	293.6	26387	263	20.0	yes	no	no	no	no

**APPENDIX G**  
**MCNP NEUTRON CROSS-SECTION LIBRARIES**

**TABLE G-2 (Cont.)**  
**Continuous-Energy and Discrete Neutron Data Libraries Maintained by X-5**

Z	ZAID	Library		Eval Date	Temp (°K)	Length words	NE	$E_{max}$			$\bar{U}$	CP	DN	UR
		AWR	Name					Source	MeV	GPD				
	74182.60c	180.3900	endf60	B-VI.0	1980	293.6	113177	12283	20.0	yes	no	no	no	no
	** W-183 **													
	74183.49c	181.3800	ures	B-VI.0	1980	300.0	119637	12616	20.0	yes	no	no	no	yes
	74183.50c	181.3800	endf5p	B-V.0	1973	293.6	58799	5843	20.0	yes	no	no	no	no
	74183.50d	181.3800	dre5	B-V.0	1973	293.6	19443	263	20.0	yes	no	no	no	no
	74183.55c	181.3800	rmccsa	B-V.2	1980	293.6	79534	8083	20.0	yes	no	no	no	no
	74183.55d	181.3800	drmcsc	B-V.2	1980	293.6	26320	263	20.0	yes	no	no	no	no
	74183.60c	181.3800	endf60	B-VI.0	1980	293.6	89350	9131	20.0	yes	no	no	no	no
	** W-184 **													
	74184.49c	182.3700	ures	B-VI.0	1980	300.0	97118	9794	20.0	yes	no	no	no	yes
	74184.50c	182.3700	endf5p	B-V.0	1973	293.6	58870	6173	20.0	yes	no	no	no	no
	74184.50d	182.3700	dre5	B-V.0	1973	293.6	17032	263	20.0	yes	no	no	no	no
	74184.55c	182.3700	rmccsa	B-V.2	1980	293.6	80006	7835	20.0	yes	no	no	no	no
	74184.55d	182.3700	drmcsc	B-V.2	1980	293.6	26110	263	20.0	yes	no	no	no	no
	74184.60c	182.3700	endf60	B-VI.0	1980	293.6	78809	7368	20.0	yes	no	no	no	no
	** W-186 **													
	74186.49c	184.3600	ures	B-VI.0	1980	300.0	102199	10485	20.0	yes	no	no	no	yes
	74186.50c	184.3600	endf5p	B-V.0	1973	293.6	63701	6866	20.0	yes	no	no	no	no
	74186.50d	184.3600	dre5	B-V.0	1973	293.6	17018	263	20.0	yes	no	no	no	no
	74186.55c	184.3600	rmccsa	B-V.2	1980	293.6	83618	8342	20.0	yes	no	no	no	no
	74186.55d	184.3600	drmcsc	B-V.2	1980	293.6	26281	263	20.0	yes	no	no	no	no
	74186.60c	184.3600	endf60	B-VI.0	1980	293.6	82010	7793	20.0	yes	no	no	no	no
Z = 75	***** Rhenium *****													
	** Re-185 **													
	75185.32c	183.3612	misc5xs[6]	LLNL	<1985	0.0	13650	1488	20.0	yes	no	no	no	no
	75185.35c	183.3641	endf85	LLNL	<1985	0.0	16038	1487	20.0	yes	no	no	no	no
	75185.42c	183.3641	endf92	LLNL	<1992	300.0	23715	2214	30.0	yes	no	no	no	no
	75185.50c	183.3640	rmccsa	B-V.0	1968	293.6	9190	1168	20.0	no	no	no	no	no
	75185.50d	183.3640	drmcsc	B-V.0	1968	293.6	4252	263	20.0	no	no	no	no	no
	75185.60c	183.3640	endf60	B-VI.0	1990	293.6	102775	16719	20.0	no	no	no	no	no
	** Re-187 **													
	75187.32c	185.3539	misc5xs[6]	LLNL	<1985	0.0	12318	1296	20.0	yes	no	no	no	no
	75187.35c	185.3497	endf85	LLNL	<1985	0.0	14769	1295	20.0	yes	no	no	no	no
	75187.42c	185.3497	endf92	LLNL	<1992	300.0	20969	1821	30.0	yes	no	no	no	no
	75187.50c	185.3500	rmccsa	B-V.0	1968	293.6	8262	959	20.0	no	no	no	no	no
	75187.50d	185.3500	drmcsc	B-V.0	1968	293.6	4675	263	20.0	no	no	no	no	no
	75187.60c	185.3500	endf60	B-VI.0	1990	293.6	96989	15624	20.0	no	no	no	no	no
Z = 77	***** Iridium *****													
	** Ir-nat **													
	77000.55c	190.5630	misc5xs[6]	T-2	1986	300.0	43071	3704	20.0	no	no	no	no	no
	** Ir-191 **													
	77191.49c	189.3200	ures	B-VI.4	1995	300.0	83955	8976	20.0	yes	no	no	no	yes
	** Ir-193 **													
	77193.49c	191.3050	ures	B-VI.4	1995	300.0	82966	8943	20.0	yes	no	no	no	yes
Z = 78	***** Platinum *****													
	** pt-nat **													
	78000.35c	193.4141	rmccsa	LLNL	<1985	0.0	15371	1497	20.0	yes	no	no	no	no
	78000.35d	193.4141	drmcsc	LLNL	<1985	0.0	6933	263	20.0	yes	no	no	no	no
	78000.40c	193.4141	endf92	LLNL	<1992	300.0	43559	5400	30.0	yes	no	no	no	no
	78000.42c	193.4141	endf92	LLNL:X-5	<1992	300.0	43559	5400	30.0	yes	no	no	no	no
Z = 79	***** Gold *****													
	** Au-197 **													
	79197.35c	195.2745	endf85	LLNL	<1985	0.0	31871	3781	20.0	yes	no	no	no	no
	79197.50c	195.2740	endf5p	B-V.0	1977	293.6	139425	22632	20.0	no	no	no	no	no
	79197.50d	195.2740	dre5	B-V.0	1977	293.6	4882	263	20.0	no	no	no	no	no
	79197.55c	195.2740	rmccsa	T-2	1983[4]	293.6	134325	17909	20.0	yes	no	no	no	no
	79197.55d	195.2740	drmcsc	T-2	1983[4]	293.6	7883	263	20.0	yes	no	no	no	no
	79197.56c	195.2740	newxs	T-2	1984	293.6	122482	11823	30.0	yes	no	no	no	no

**APPENDIX G**  
**MCNP NEUTRON CROSS-SECTION LIBRARIES**

**TABLE G-2 (Cont.)**  
**Continuous-Energy and Discrete Neutron Data Libraries Maintained by X-5**

ZAJD	Library		Eval Date	Temp (°K)	Length words	NE	$E_{max}$			$\bar{U}$	CP	DN	UR
	AWR	Name					Source	MeV	GPD				
79197.56d	195.2740	newxsd	T-2	1984	293.6	38801	263	20.0	yes	no	no	no	no
79197.60c	195.2740	endf60	B-VI.1	1984	293.6	161039	17724	30.0	yes	no	no	no	no
Z = 80 ***** Mercury *****													
** Hg-nat **													
80000.40c	198.8668	endf92	LLNL	<1992	300.0	29731	2507	30.0	yes	no	no	no	no
80000.42c	198.8668	endf92	LLNL:X-5	<1992	300.0	29731	2507	30.0	yes	no	no	no	no
Z = 82 ***** Lead *****													
** Pb-nat **													
82000.35c	205.4200	endf85	LLNL	<1985	0.0	6639	349	20.0	yes	no	no	no	no
82000.42c	205.4200	endf92	LLNL	<1992	300.0	270244	18969	30.0	yes	no	no	no	no
82000.50c	205.4300	rmccs	B-V.0	1976	293.6	37633	1346	20.0	yes	no	no	no	no
82000.50d	205.4300	drmcscs	B-V.0	1976	293.6	20649	263	20.0	yes	no	no	no	no
** Pb-206 **													
82206.60c	204.2000	endf60	B-VI.0	1989	293.6	148815	12872	20.0	yes	no	no	no	no
** Pb-207 **													
82207.60c	205.2000	endf60	B-VI.1	1991	293.6	111750	7524	20.0	yes	no	no	no	no
** Pb-208 **													
82208.60c	206.1900	endf60	B-VI.0	1989	293.6	70740	5105	20.0	yes	no	no	no	no
Z = 83 ***** Bismuth *****													
** Bi-209 **													
83209.35c	207.1851	endf85	LLNL	<1985	0.0	18316	1303	20.0	yes	no	no	no	no
83209.42c	207.1851	endf92	LLNL	<1992	300.0	20921	1200	30.0	yes	no	no	no	no
83209.50c	207.1850	endf5u	B-V.0	1980	293.6	14939	1300	20.0	yes	no	no	no	no
83209.50d	207.1850	dre5	B-V.0	1980	293.6	7516	263	20.0	yes	no	no	no	no
83209.51c	207.1850	rmccs	B-V.0	1980	293.6	13721	1186	20.0	yes	no	no	no	no
83209.51d	207.1850	drmcscs	B-V.0	1980	293.6	7516	263	20.0	yes	no	no	no	no
83209.60c	207.1850	endf60	B-VI.0	1989	293.6	100138	8427	20.0	yes	no	no	no	no
Z = 90 ***** Thorium *****													
** Th-230 **													
90230.60c	228.0600	endf60	B-VI.0	1977	293.6	35155	5533	20.0	no	tot	no	no	no
** Th-231 **													
90231.35c	229.0516	endf85	LLNL	<1985	0.0	9157	308	20.0	yes	pr	no	no	no
90231.42c	229.0516	endf92	LLNL	<1992	300.0	15712	187	30.0	yes	both	no	no	no
** Th-232 **													
90232.35c	230.0447	endf85	LLNL	<1985	0.0	56091	6169	20.0	yes	pr	no	no	no
90232.42c	230.0447	endf92	LLNL	<1992	300.0	109829	13719	30.0	yes	both	no	no	no
90232.49c	230.0400	ures	B-VI.0	1977	300.0	305942	41414	20.0	yes	both	no	no	yes
90232.50c	230.0400	endf5u	B-V.0	1977	293.6	152782	17901	20.0	yes	both	no	no	no
90232.50d	230.0400	dre5	B-V.0	1977	293.6	11937	263	20.0	yes	both	no	no	no
90232.51c	230.0400	rmccs	B-V.0	1977	293.6	17925	1062	20.0	yes	both	no	no	no
90232.51d	230.0400	drmcscs	B-V.0	1977	293.6	11937	263	20.0	yes	both	no	no	no
90232.60c	230.0400	endf60	B-VI.0	1977	293.6	127606	16381	20.0	yes	both	no	no	no
90232.61c	230.0400	endf6dn	B-VI.0	1977	293.6	132594	16381	20.0	yes	both	no	yes	no
** Th-233 **													
90233.35c	231.0396	endf85	LLNL	<1985	0.0	9352	348	20.0	yes	pr	no	no	no
90233.42c	231.0396	endf92	LLNL	<1992	300.0	16015	206	30.0	yes	both	no	no	no
Z = 91 ***** Protactinium *****													
** Pa-231 **													
91231.60c	229.0500	endf60	B-VI.0	1977	293.6	19835	2610	20.0	no	both	no	no	no
91231.61c	229.0500	endf6dn	B-VI.0	1977	293.6	24733	2610	20.0	no	both	no	yes	no
** Pa-233 **													
91233.35c	231.0383	endf85	LLNL	<1985	0.0	19170	1910	20.0	yes	pr	no	no	no
91233.42c	231.0383	endf92	LLNL	<1992	300.0	27720	1982	30.0	yes	both	no	no	no
91233.50c	231.0380	endf5u	B-V.0	1974	293.6	19519	2915	20.0	no	tot	no	no	no
91233.50d	231.0380	dre5	B-V.0	1974	293.6	3700	263	20.0	no	tot	no	no	no
91233.51c	231.0380	rmccs	B-V.0	1974	293.6	5641	637	20.0	no	tot	no	no	no

**APPENDIX G**  
**MCNP NEUTRON CROSS-SECTION LIBRARIES**

**TABLE G-2 (Cont.)**  
**Continuous-Energy and Discrete Neutron Data Libraries Maintained by X-5**

ZAID	AWR	Library		Eval Date	Temp (°K)	Length words	NE	$E_{max}$			$\bar{U}$	CP	DN	UR
		Name	Source					MeV	GPD					
91233.51d	231.0380	drmccs	B-V.0	1974	293.6	3700	263	20.0	no	tot	no	no	no	
Z = 92 ***** Uranium *****														
** U-232 **														
92232.49c	230.0400	ures	B-VI.0	1977	300.0	21813	2820	20.0	no	both	no	no	yes	
92232.60c	230.0400	endf60	B-VI.0	1977	293.6	13839	1759	20.0	no	both	no	no	no	
92232.61c	230.0400	endf6dn	B-VI.0	1977	293.6	18734	1759	20.0	no	both	no	yes	no	
** U-233 **														
92233.35c	231.0377	endl85	LLNL	<1985	0.0	29674	2924	20.0	yes	pr	no	no	no	
92233.42c	231.0377	endl92	LLNL	<1992	300.0	29521	2163	30.0	yes	both	no	no	no	
92233.49c	231.0430	ures	B-VI.0	1978	300.0	47100	4601	20.0	yes	both	no	no	yes	
92233.50c	231.0430	rmccs	B-V.0	1978	293.6	18815	2293	20.0	no	both	no	no	no	
92233.50d	231.0430	drmccs	B-V.0	1978	293.6	4172	263	20.0	no	both	no	no	no	
92233.60c	231.0430	endf60[14]	B-VI.0	1978	293.6	32226	3223	20.0	yes	both	no	no	no	
92233.61c	231.0430	endf6dn	B-VI.0	1978	293.6	37218	3223	20.0	yes	both	no	yes	no	
** U-234 **														
92234.35c	232.0304	endl85	LLNL	<1985	0.0	8557	237	20.0	yes	pr	no	no	no	
92234.42c	232.0304	endl92	LLNL	<1992	300.0	13677	149	30.0	yes	both	no	no	no	
92234.49c	232.0300	ures	B-VI.0	1978	300.0	161296	22539	20.0	no	both	no	no	yes	
92234.50c	232.0300	endf5p	B-V.0	1978	293.6	89433	12430	20.0	no	tot	no	no	no	
92234.50d	232.0300	dre5	B-V.0	1978	293.6	4833	263	20.0	no	tot	no	no	no	
92234.51c	232.0300	rmccs	B-V.0	1978	293.6	6426	672	20.0	no	tot	no	no	no	
92234.51d	232.0300	drmccs	B-V.0	1978	293.6	4833	263	20.0	no	tot	no	no	no	
92234.60c	232.0300	endf60	B-VI.0	1978	293.6	77059	10660	17.5	no	both	no	no	no	
92234.61c	232.0300	endf6dn	B-VI.0	1978	293.6	82047	10660	17.5	no	both	no	yes	no	
** U-235 **														
92235.01c	233.0250	endfht	B-VI.2	1989	1.2e4	234381	18913	20.0	yes	both	no	no	no	
92235.02c	233.0250	endfht	B-VI.2	1989	1.2e5	138369	8245	20.0	yes	both	no	no	no	
92235.03c	233.0250	endfht	B-VI.2	1989	1.2e6	102567	4267	20.0	yes	both	no	no	no	
92235.04c	233.0250	endfht	B-VI.2	1989	1.2e7	85917	2417	20.0	yes	both	no	no	no	
92235.05c	233.0250	endfht	B-VI.2	1989	1.2e8	79635	1719	20.0	yes	both	no	no	no	
92235.06c	233.0250	endfht	B-V.0	1977	1.2e4	47562	3712	20.0	yes	both	no	no	no	
92235.07c	233.0250	endfht	B-V.0	1977	1.2e5	32721	2063	20.0	yes	both	no	no	no	
92235.08c	233.0250	endfht	B-V.0	1977	1.2e6	28905	1639	20.0	yes	both	no	no	no	
92235.09c	233.0250	endfht	B-V.0	1977	1.2e7	27627	1497	20.0	yes	both	no	no	no	
92235.10c	233.0250	endfht	B-V.0	1977	1.2e8	27312	1462	20.0	yes	both	no	no	no	
92235.11c	233.0250	endf62mt[15]	B-VI.2	1989	77.0	696398	78912	20.0	yes	both	no	no	no	
92235.12c	233.0250	endf62mt[15]	B-VI.2	1989	400.0	411854	43344	20.0	yes	both	no	no	no	
92235.13c	233.0250	endf62mt[15]	B-VI.2	1989	500.0	379726	39328	20.0	yes	both	no	no	no	
92235.14c	233.0250	endf62mt[15]	B-VI.2	1989	600.0	353678	36072	20.0	yes	both	no	no	no	
92235.15c	233.0250	endf62mt[15]	B-VI.2	1989	800.0	316622	31440	20.0	yes	both	no	no	no	
92235.16c	233.0250	endf62mt[15]	B-VI.2	1989	900.0	300278	29397	20.0	yes	both	no	no	no	
92235.17c	233.0250	endf62mt[15]	B-VI.2	1989	1200	269062	25495	20	yes	both	no	no	no	
92235.42c	233.0248	endl92	LLNL	<1992	300.0	72790	5734	30.0	yes	both	no	no	no	
92235.49c	233.0250	ures	B-VI.4	1996	300.0	647347	72649	20.0	yes	both	no	no	yes	
92235.50c	233.0250	rmccs	B-V.0	1977	293.6	60489	5725	20.0	yes	both	no	no	no	
92235.50d	233.0250	drmccs	B-V.0	1977	293.6	11788	263	20.0	yes	both	no	no	no	
92235.52c	233.0250	endf5mt[1]	B-V.0	1977	587.2	65286	6320	20.0	yes	both	no	no	no	
92235.53c	233.0250	endf5mt[1]	B-V.0	1977	587.2	36120	2685	20.0	yes	both	no	no	no	
92235.54c	233.0250	endf5mt[1]	B-V.0	1977	880.8	36008	2671	20.0	yes	both	no	no	no	
92235.56c	233.0250	endf5ht	B-V.0	1977	1.2e4	28494	1729	20.0	yes	both	no	no	no	
92235.57c	233.0250	endf5ht	B-V.0	1977	1.2e5	25214	1319	20.0	yes	both	no	no	no	
92235.58c	233.0250	endf5ht	B-V.0	1977	1.2e6	22966	1038	20.0	yes	both	no	no	no	
92235.59c	233.0250	endf5ht	B-V.0	1977	1.2e7	22406	968	20.0	yes	both	no	no	no	
92235.60c	233.0250	endf60	B-VI.2	1989	293.6	289975	28110	20.0	yes	both	no	no	no	
92235.61c	233.0250	endf6dn	B-VI.2	1989	293.6	294963	28110	20.0	yes	both	no	yes	no	
** U-236 **														
92236.35c	234.0178	endl85	LLNL	<1985	0.0	8699	224	20.0	yes	pr	no	no	no	
92236.42c	234.0178	endl92	LLNL	<1992	300.0	14595	311	30.0	yes	both	no	no	no	
92236.49c	234.0180	ures	B-VI.0	1989	300.0	159074	20865	20.0	no	both	no	no	yes	
92236.50c	234.0180	endf5p	B-V.0	1978	293.6	138715	19473	20.0	no	tot	no	no	no	
92236.50d	234.0180	dre5	B-V.0	1978	293.6	4838	263	20.0	no	tot	no	no	no	
92236.51c	234.0180	rmccs	B-V.0	1978	293.6	7302	800	20.0	no	tot	no	no	no	
92236.51d	234.0180	drmccs	B-V.0	1978	293.6	4838	263	20.0	no	tot	no	no	no	
92236.60c	234.0180	endf60	B-VI.0	1989	293.6	82819	10454	20.0	no	both	no	no	no	

**APPENDIX G  
MCNP NEUTRON CROSS-SECTION LIBRARIES**

**TABLE G-2 (Cont.)  
Continuous-Energy and Discrete Neutron Data Libraries Maintained by X-5**

ZAID	AWR	Library		Eval Date	Temp (°K)	Length words	NE	$E_{max}$			$\bar{U}$	CP	DN	UR
		Name	Source					MeV	GPD					
92236.61c	234.0180	endf6dn	B-VI.0	1989	293.6	87807	10454	20.0	no	both	no	yes	no	
** U-237 **														
92237.35c	235.0123	endl85	LLNL	<1985	0.0	9364	353	20.0	yes	pr	no	no	no	
92237.42c	235.0123	endl92	LLNL	<1992	300.0	13465	210	30.0	yes	both	no	no	no	
92237.50c	235.0120	endf5p	B-V.0	1976	293.6	32445	3293	20.0	yes	tot	no	no	no	
92237.50d	235.0120	dre5	B-V.0	1976	293.6	8851	263	20.0	yes	tot	no	no	no	
92237.51c	235.0120	rmccs	B-V.0	1976	293.6	10317	527	20.0	yes	tot	no	no	no	
92237.51d	235.0120	drmcchs	B-V.0	1976	293.6	8851	263	20.0	yes	tot	no	no	no	
** U-238 **														
92238.01c	236.0060	endfht	B-VI.2	1993	1.2e4	296788	30203	20.0	yes	both	no	no	no	
92238.02c	236.0060	endfht	B-VI.2	1993	1.2e5	138937	12664	20.0	yes	both	no	no	no	
92238.03c	236.0060	endfht	B-VI.2	1993	1.2e6	77638	5853	20.0	yes	both	no	no	no	
92238.04c	236.0060	endfht	B-VI.2	1993	1.2e7	54625	3296	20.0	yes	both	no	no	no	
92238.05c	236.0060	endfht	B-VI.2	1993	1.2e8	44356	2155	20.0	yes	both	no	no	no	
92238.06c	236.0060	endfht	B-V.0	1979	1.2e4	185164	18732	20.0	yes	both	no	no	no	
92238.07c	236.0060	endfht	B-V.0	1979	1.2e5	85705	7681	20.0	yes	both	no	no	no	
92238.08c	236.0060	endfht	B-V.0	1979	1.2e6	46123	3283	20.0	yes	both	no	no	no	
92238.09c	236.0060	endfht	B-V.0	1979	1.2e7	34774	2022	20.0	yes	both	no	no	no	
92238.10c	236.0060	endfht	B-V.0	1979	1.2e8	30193	1513	20.0	yes	both	no	no	no	
92238.11c	236.0060	endf62mt[15]	B-VI.2	1993	77.0	621385	74481	20.0	yes	both	no	no	no	
92238.12c	236.0060	endf62mt[15]	B-VI.2	1993	400.0	456593	53882	20.0	yes	both	no	no	no	
92238.13c	236.0060	endf62mt[15]	B-VI.2	1993	500.0	433681	51018	20.0	yes	both	no	no	no	
92238.14c	236.0060	endf62mt[15]	B-VI.2	1993	600.0	414185	48581	20.0	yes	both	no	no	no	
92238.15c	236.0060	endf62mt[15]	B-VI.2	1993	800.0	386305	45096	20.0	yes	both	no	no	no	
92238.16c	236.0060	endf62mt[15]	B-VI.2	1993	900.0	372625	43386	20.0	yes	both	no	no	no	
92238.17c	236.0060	endf62mt[15]	B-VI.2	1993	1200.0	348137	40325	20.0	yes	both	no	no	no	
92238.21c	236.0060	100xs[3]	T-2:X-5	1989	300.0	279245	30911	100.0	yes	both	no	no	no	
92238.35c	236.0058	endl85	LLNL	<1985	0.0	27168	1845	20.0	yes	pr	no	no	no	
92238.42c	236.0058	endl92	LLNL	<1992	300.0	107739	7477	30.0	yes	both	no	no	no	
92238.49c	236.0060	ures	B-VI.2	1993	300.0	705623	85021	20.0	yes	both	no	no	yes	
92238.50c	236.0060	rmccs	B-V.0	1979	293.6	88998	9285	20.0	yes	both	no	no	no	
92238.50d	236.0060	drmcchs	B-V.0	1979	293.6	16815	263	20.0	yes	both	no	no	no	
92238.52c	236.0060	endf5mt[1]	B-V.0	1979	587.2	123199	8454	20.0	yes	both	no	no	no	
92238.53c	236.0060	endf5mt[1]	B-V.0	1979	587.2	160107	17876	20.0	yes	both	no	no	no	
92238.54c	236.0060	endf5mt[1]	B-V.0	1979	880.8	160971	17984	20.0	yes	both	no	no	no	
92238.56c	233.0250	endf5ht	B-V.0	1979	1.2e4	82470	8176	20.0	yes	both	no	no	no	
92238.57c	233.0250	endf5ht	B-V.0	1979	1.2e5	47206	3768	20.0	yes	both	no	no	no	
92238.58c	233.0250	endf5ht	B-V.0	1979	1.2e6	27814	1344	20.0	yes	both	no	no	no	
92238.59c	233.0250	endf5ht	B-V.0	1979	1.2e7	22078	627	20.0	yes	both	no	no	no	
92238.60c	236.0060	endf60	B-VI.2	1993	293.6	206322	22600	20.0	yes	both	no	no	no	
92238.61c	236.0060	endf6dn	B-VI.2	1993	293.6	211310	22600	20.0	yes	both	no	yes	no	
** U-239 **														
92239.35c	237.0007	rmccsa	LLNL	<1985	0.0	9809	394	20.0	yes	pr	no	no	no	
92239.35d	237.0007	drmcchs	LLNL	<1985	0.0	9286	263	20.0	yes	pr	no	no	no	
92239.42c	237.0007	endl92	LLNL	<1992	300.0	14336	205	30.0	yes	both	no	no	no	
** U-240 **														
92240.35c	237.9944	endl85	LLNL	<1985	0.0	8495	218	20.0	yes	pr	no	no	no	
92240.42c	237.9944	endl92	LLNL	<1992	300.0	14000	128	30.0	yes	both	no	no	no	
Z = 93 ***** Neptunium *****														
** Np-235 **														
93235.35c	233.0249	endl85	LLNL	<1985	0.0	9490	364	20.0	yes	pr	no	no	no	
93235.42c	233.0249	endl92	LLNL	<1992	300.0	17717	660	30.0	yes	both	no	no	no	
** Np-236 **														
93236.35c	234.0188	endl85	LLNL	<1985	0.0	8821	284	20.0	yes	pr	no	no	no	
93236.42c	234.0188	endl92	LLNL	<1992	300.0	13464	179	30.0	yes	both	no	no	no	
** Np-237 **														
93237.35c	235.0118	endl85	LLNL	<1985	0.0	20225	1678	20.0	yes	pr	no	no	no	
93237.42c	235.0118	endl92	LLNL	<1992	300.0	31966	2477	30.0	yes	both	no	no	no	
93237.50c	235.0120	endf5p	B-V.0	1978	293.6	63223	8519	20.0	no	tot	no	no	no	
93237.50d	235.0120	dre5	B-V.0	1978	293.6	5267	263	20.0	no	tot	no	no	no	
93237.55c	235.0120	rmccsa	T-2	1984	293.6	32558	1682	20.0	no	both	no	no	no	
93237.55d	235.0120	drmcchs	T-2	1984	293.6	20484	263	20.0	no	both	no	no	no	
93237.60c	235.0118	endf60	B-VI.1	1990	293.6	105150	7218	20.0	yes	both	no	no	no	
93237.61c	235.0118	endf6dn	B-VI.1	1990	293.6	110048	7218	20.0	yes	both	no	yes	no	

**APPENDIX G**  
**MCNP NEUTRON CROSS-SECTION LIBRARIES**

**TABLE G-2 (Cont.)**  
**Continuous-Energy and Discrete Neutron Data Libraries Maintained by X-5**

ZAID	Library		Eval Date	Temp (°K)	Length words	NE	$E_{max}$			$\bar{U}$	CP	DN	UR
	AWR	Name					Source	MeV	GPD				
** Np-238 **													
93238.35c	236.0060	endl85	LLNL	<1985	0.0	8878	282	20.0	yes	pr	no	no	no
93238.42c	236.0060	endl92	LLNL	<1992	300.0	13445	165	30.0	yes	both	no	no	no
** Np-239 **													
93239.60c	236.9990	endf60	B-VI.0	1988	293.6	7406	562	20.0	no	tot	no	no	no
Z = 94 ***** Plutonium *****													
** Pu-236 **													
94236.60c	234.0180	endf60	B-VI.0	1978	293.6	33448	4610	20.0	no	tot	no	no	no
** Pu-237 **													
94237.35c	235.0120	endl85	LLNL	<1985	0.0	11300	202	20.0	yes	pr	no	no	no
94237.42c	235.0120	endl92	LLNL	<1992	300.0	17284	279	30.0	yes	both	no	no	no
94237.60c	235.0120	endf60	B-VI.0	1978	293.6	3524	257	20.0	no	tot	no	no	no
** Pu-238 **													
94238.35c	236.0046	endl85	LLNL	<1985	0.0	15619	958	20.0	yes	pr	no	no	no
94238.42c	236.0046	endl92	LLNL	<1992	300.0	30572	2177	30.0	yes	both	no	no	no
94238.49c	236.0045	ures	B-VI.0	1978	300.0	41814	5337	20.0	no	both	no	no	yes
94238.50c	236.1670	endf5p	B-V.0	1978	293.6	18763	2301	20.0	no	tot	no	no	no
94238.50d	236.1670	dre5	B-V.0	1978	293.6	5404	263	20.0	no	tot	no	no	no
94238.51c	236.1670	rmccs	B-V.0	1978	293.6	6067	537	20.0	no	tot	no	no	no
94238.51d	236.1670	drmccs	B-V.0	1978	293.6	5404	263	20.0	no	tot	no	no	no
94238.60c	236.0045	endf60	B-VI.0	1978	293.6	29054	3753	20.0	no	both	no	no	no
94238.61c	236.0045	endf6dn	B-VI.0	1978	293.6	33952	3753	20.0	no	both	no	yes	no
** Pu-239 **													
94239.01c	236.9986	endfht	B-VI.2	1993	1.2e4	229878	18004	20.0	yes	both	no	no	no
94239.02c	236.9986	endfht	B-VI.2	1993	1.2e5	126018	6464	20.0	yes	both	no	no	no
94239.03c	236.9986	endfht	B-VI.2	1993	1.2e6	97362	3280	20.0	yes	both	no	no	no
94239.04c	236.9986	endfht	B-VI.2	1993	1.2e7	85788	1994	20.0	yes	both	no	no	no
94239.05c	236.9986	endfht	B-VI.2	1993	1.2e8	81423	1509	20.0	yes	both	no	no	no
94239.06c	236.9990	endfht	B-V.2	1983	1.2e4	76790	6005	20.0	yes	both	no	no	no
94239.07c	236.9990	endfht	B-V.2	1983	1.2e5	45461	2524	20.0	yes	both	no	no	no
94239.08c	236.9990	endfht	B-V.2	1983	1.2e6	36236	1499	20.0	yes	both	no	no	no
94239.09c	236.9990	endfht	B-V.2	1983	1.2e7	33797	1228	20.0	yes	both	no	no	no
94239.10c	236.9990	endfht	B-V.2	1983	1.2e8	33230	1165	20.0	yes	both	no	no	no
94239.11c	236.9986	endf62mt[15]	B-VI.2	1993	77.0	568756	62522	20.0	yes	both	no	no	no
94239.12c	236.9986	endf62mt[15]	B-VI.2	1993	400.0	418556	43747	20.0	yes	both	no	no	no
94239.13c	236.9986	endf62mt[15]	B-VI.2	1993	500.0	395964	40923	20.0	yes	both	no	no	no
94239.14c	236.9986	endf62mt[15]	B-VI.2	1993	600.0	377116	38567	20.0	yes	both	no	no	no
94239.15c	236.9986	endf62mt[15]	B-VI.2	1993	800.0	350292	35214	20.0	yes	both	no	no	no
94239.16c	236.9986	endf62mt[15]	B-VI.2	1993	900.0	338236	33707	20.0	yes	both	no	no	no
94239.17c	236.9986	endf62mt[15]	B-VI.2	1993	1200.0	312572	30499	20	yes	both	no	no	no
94239.42c	236.9986	endl92	LLNL	<1992	300.0	93878	6827	30.0	yes	both	no	no	no
94239.49c	236.9986	ures	B-VI.2	1993	300.0	595005	64841	20.0	yes	both	no	no	yes
94239.50c	236.9990	endf5p	B-V.0	1976	293.6	74049	7809	20.0	yes	both	no	no	no
94239.50d	236.9990	dre5	B-V.0	1976	293.6	12631	263	20.0	yes	both	no	no	no
94239.55c	236.9990	rmccs	B-V.2	1983	293.6	102099	10318	20.0	yes	both	no	no	no
94239.55d	236.9990	drmccs	B-V.2	1983	293.6	20727	263	20.0	yes	both	no	no	no
94239.56c	236.9990	endf5ht	B-V.2	1983	1.2e4	45529	2547	20.0	yes	both	no	no	no
94239.57c	236.9990	endf5ht	B-V.2	1983	1.2e5	36201	1381	20.0	yes	both	no	no	no
94239.58c	236.9990	endf5ht	B-V.2	1983	1.2e6	31049	737	20.0	yes	both	no	no	no
94239.59c	236.9990	endf5ht	B-V.2	1983	1.2e7	29761	576	20.0	yes	both	no	no	no
94239.60c	236.9986	endf60	B-VI.2	1993	293.6	283354	26847	20.0	yes	both	no	no	no
94239.61c	236.9986	endf6dn	B-VI.2	1993	293.6	288252	26847	20.0	yes	both	no	yes	no
** Pu-240 **													
94240.42c	237.9916	endl92	LLNL	<1992	300.0	198041	16626	30.0	yes	both	no	no	no
94240.49c	237.9920	ures	B-VI.2	1986	300.0	341542	41596	20.0	yes	both	no	no	yes
94240.50c	237.9920	rmccs	B-V.0	1977	293.6	58917	6549	20.0	yes	both	no	no	no
94240.50d	237.9920	drmccs	B-V.0	1977	293.6	9569	263	20.0	yes	both	no	no	no
94240.60c	237.9920	endf60	B-VI.2	1986	293.6	133071	15676	20.0	yes	both	no	no	no
94240.61c	237.9920	endf6dn	B-VI.2	1986	293.6	137969	15676	20.0	yes	both	no	yes	no
** Pu-241 **													
94241.35c	238.9860	endl85	LLNL	<1985	0.0	8844	257	20.0	yes	pr	no	no	no
94241.42c	238.9860	endl92	LLNL	<1992	300.0	14108	203	30.0	yes	both	no	no	no
94241.49c	238.9780	ures	B-VI.3	1994	300.0	155886	17753	20.0	yes	both	no	no	yes
94241.50c	238.9780	endf5p	B-V.0	1977	293.6	38601	3744	20.0	yes	both	no	no	no

**APPENDIX G**  
**MCNP NEUTRON CROSS-SECTION LIBRARIES**

**TABLE G-2 (Cont.)**  
**Continuous-Energy and Discrete Neutron Data Libraries Maintained by X-5**

ZAID	AWR	Library		Eval Date	Temp (°K)	Length words	NE	E <sub>max</sub>			̄U	CP	DN	UR
		Name	Source					MeV	GPD					
94241.50d	238.9780	dre5	B-V.0	1977	293.6	11575	263	20.0	yes	both	no	no	no	
94241.51c	238.9780	rmccs	B-V.0	1977	293.6	13403	623	20.0	yes	both	no	no	no	
94241.51d	238.9780	drmccs	B-V.0	1977	293.6	11575	263	20.0	yes	both	no	no	no	
94241.60c	238.9780	endf60	B-VI.1	1988	293.6	76453	8112	20.0	yes	both	no	no	no	
94241.61c	238.9780	endf6dn	B-VI.1	1988	293.6	81351	8112	20.0	yes	both	no	yes	no	
** Pu-242 **														
94242.35c	239.9793	endl85	LLNL	<1985	0.0	21159	1724	20.0	yes	pr	no	no	no	
94242.42c	239.9793	endl92	LLNL	<1992	300.0	48688	4287	30.0	yes	both	no	no	no	
94242.49c	239.9790	ures	B-VI.0	1978	300.0	130202	14922	20.0	yes	both	no	no	yes	
94242.50c	239.9790	endf5p	B-V.0	1978	293.6	71429	7636	20.0	yes	both	no	no	no	
94242.50d	239.9790	dre5	B-V.0	1978	293.6	12463	263	20.0	yes	both	no	no	no	
94242.51c	239.9790	rmccs	B-V.0	1978	293.6	15702	728	20.0	yes	both	no	no	no	
94242.51d	239.9790	drmccs	B-V.0	1978	293.6	12463	263	20.0	yes	both	no	no	no	
94242.60c	239.9790	endf60	B-VI.0	1978	293.6	73725	7896	20.0	yes	both	no	no	no	
94242.61c	239.9790	endf6dn	B-VI.0	1978	293.6	78623	7896	20.0	yes	both	no	yes	no	
** Pu-243 **														
94243.35c	240.9740	endl85	LLNL	<1985	0.0	10763	485	20.0	yes	pr	no	no	no	
94243.42c	240.9740	endl92	LLNL	<1992	300.0	20253	745	30.0	yes	both	no	no	no	
94243.60c	240.9740	endf60	B-VI.2	1976	293.6	45142	4452	20.0	yes	tot	no	no	no	
** Pu-244 **														
94244.60c	241.9680	endf60	B-VI.0	1978	293.6	23654	3695	20.0	no	tot	no	no	no	
Z = 95 ***** Americium *****														
** Am-241 **														
95241.35c	238.9860	endl85	LLNL	<1985	0.0	25290	1982	20.0	yes	pr	no	no	no	
95241.42c	238.9860	endl92	LLNL	<1992	300.0	32579	2011	30.0	yes	both	no	no	no	
95241.50c	238.9860	endf5u	B-V.0	1978	293.6	42084	4420	20.0	yes	tot	no	no	no	
95241.50d	238.9860	dre5	B-V.0	1978	293.6	9971	263	20.0	yes	tot	no	no	no	
95241.51c	238.9860	rmccs	B-V.0	1978	293.6	12374	713	20.0	yes	tot	no	no	no	
95241.51d	238.9860	drmccs	B-V.0	1978	293.6	9971	263	20.0	yes	tot	no	no	no	
95241.60c	238.9860	endf60	T-2	1994	300.0	168924	13556	30.0	yes	both	no	no	no	
95241.61c	238.9860	endf6dn	T-2	1994	300.0	173822	13556	30.0	yes	both	no	yes	no	
** Am-242 ms **														
95242.35c	239.9801	endl85	LLNL	<1985	0.0	20908	1817	20.0	yes	pr	no	no	no	
95242.42c	239.9801	endl92	LLNL	<1992	300.0	21828	1368	20.0	yes	both	no	no	no	
95242.50c	239.9800	endf5u	B-V.0	1978	293.6	8593	323	20.0	yes	tot	no	no	no	
95242.50d	239.9800	dre5	B-V.0	1978	293.6	9048	263	20.0	yes	tot	no	no	no	
95242.51c	239.9800	rmccs	B-V.0	1978	293.6	8502	317	20.0	yes	tot	no	no	no	
95242.51d	239.9800	drmccs	B-V.0	1978	293.6	9048	263	20.0	yes	tot	no	no	no	
** Am-243 **														
95243.35c	240.9733	endl85	LLNL	<1985	0.0	39400	4093	20.0	yes	pr	no	no	no	
95243.42c	240.9733	endl92	LLNL	<1992	300.0	52074	4867	30.0	yes	both	no	no	no	
95243.50c	240.9730	endf5u	B-V.0	1978	293.6	92015	11921	20.0	yes	tot	no	no	no	
95243.50d	240.9730	dre5	B-V.0	1978	293.6	11742	263	20.0	yes	tot	no	no	no	
95243.51c	240.9730	rmccs	B-V.0	1978	293.6	13684	757	20.0	yes	tot	no	no	no	
95243.51d	240.9730	drmccs	B-V.0	1978	293.6	11742	263	20.0	yes	tot	no	no	no	
95243.60c	240.9730	endf60	B-VI.0	1988	293.6	104257	11984	20.0	yes	both	no	no	no	
95243.61c	240.9730	endf6dn	B-VI.0	1988	293.6	109155	11984	20.0	yes	both	no	yes	no	
Z = 96 ***** Curium *****														
** Cm-241 **														
96241.60c	238.9870	endf60	B-VI.0	1978	293.6	3132	278	20.0	no	tot	no	no	no	
** Cm-242 **														
96242.35c	239.9794	endl85	LLNL	<1985	0.0	21653	1891	20.0	yes	pr	no	no	no	
96242.42c	239.9794	endl92	LLNL	<1992	300.0	37766	3141	30.0	yes	both	no	no	no	
96242.50c	239.9790	endf5u	B-V.0	1978	293.6	30897	3113	20.0	yes	tot	no	no	no	
96242.50d	239.9790	dre5	B-V.0	1978	293.6	8903	263	20.0	yes	tot	no	no	no	
96242.51c	239.9790	rmccs	B-V.0	1978	293.6	9767	472	20.0	yes	tot	no	no	no	
96242.51d	239.9790	drmccs	B-V.0	1978	293.6	8903	263	20.0	yes	tot	no	no	no	
96242.60c	239.9790	endf60	B-VI.0	1978	293.6	34374	3544	20.0	yes	both	no	no	no	
96242.61c	239.9790	endf6dn	B-VI.0	1978	293.6	39269	3544	20.0	yes	both	no	yes	no	
** Cm-243 **														
96243.35c	240.9733	endl85	LLNL	<1985	0.0	21577	1880	20.0	yes	pr	no	no	no	
96243.42c	240.9733	endl92	LLNL	<1992	300.0	21543	1099	30.0	yes	both	no	no	no	



**APPENDIX G**  
**MCNP NEUTRON CROSS-SECTION LIBRARIES**

**TABLE G-2 (Cont.)**  
**Continuous-Energy and Discrete Neutron Data Libraries Maintained by X-5**

Z AID	AWR	Library		Eval Date	Temp (°K)	Length words	NE	$E_{max}$			$\bar{U}$	CP	DN	UR
		Name	Source					MeV	GPD					
96243.60c	240.9730	endf60	B-VI.0	1978	293.6	18860	1445	20.0	yes	tot	no	no	no	
** Cm-244 **														
96244.35c	241.9661	endl85	LLNL	<1985	0.0	21196	1815	20.0	yes	pr	no	no	no	
96244.42c	241.9661	endl92	LLNL	<1992	300.0	46590	4198	30.0	yes	both	no	no	no	
96244.49c	241.9660	ures	B-VI.0	1978	300.0	97975	11389	20.0	yes	pr	no	no	yes	
96244.50c	241.9660	endf5u	B-V.0	1978	293.6	45991	4919	20.0	yes	tot	no	no	no	
96244.50d	241.9660	dre5	B-V.0	1978	293.6	9509	263	20.0	yes	tot	no	no	no	
96244.51c	241.9660	rmccs	B-V.0	1978	293.6	10847	566	20.0	yes	tot	no	no	no	
96244.51d	241.9660	drmccs	B-V.0	1978	293.6	9509	263	20.0	yes	tot	no	no	no	
96244.60c	241.9660	endf60	B-VI.0	1978	293.6	73001	8294	20.0	yes	tot	no	no	no	
** Cm-245 **														
96245.35c	242.9602	endl85	LLNL	<1985	0.0	24128	2230	20.0	yes	pr	no	no	no	
96245.42c	242.9602	endl92	LLNL	<1992	300.0	25678	1564	30.0	yes	both	no	no	no	
96245.60c	242.9600	endf60	B-VI.2	1979	293.6	29535	2636	20.0	yes	both	no	no	no	
96245.61c	242.9600	endf6dn	B-VI.2	1979	293.6	34433	2636	20.0	yes	both	no	yes	no	
** Cm-246 **														
96246.35c	243.9534	endl85	LLNL	<1985	0.0	12489	711	20.0	yes	pr	no	no	no	
96246.42c	243.9534	endl92	LLNL	<1992	300.0	24550	1376	30.0	yes	both	no	no	no	
96246.60c	243.9530	endf60	B-VI.2	1976	293.6	37948	3311	20.0	yes	tot	no	no	no	
** Cm-247 **														
96247.35c	244.9479	endl85	LLNL	<1985	0.0	20265	1654	20.0	yes	pr	no	no	no	
96247.42c	244.9479	endl92	LLNL	<1992	300.0	39971	3256	30.0	yes	both	no	no	no	
96247.60c	244.9500	endf60	B-VI.2	1976	293.6	38800	3679	20.0	yes	tot	no	no	no	
** Cm-248 **														
96248.35c	245.9413	endl85	LLNL	<1985	0.0	18178	1425	20.0	yes	pr	no	no	no	
96248.42c	245.9413	endl92	LLNL	<1992	300.0	40345	3355	30.0	yes	both	no	no	no	
96248.60c	245.9410	endf60	B-VI.0	1978	293.6	83452	9706	20.0	yes	tot	no	no	no	
Z = 97 ***** Berkelium *****														
** Bk-249 **														
97249.35c	246.9353	endl85	LLNL	<1985	0.0	11783	633	20.0	yes	pr	no	no	no	
97249.42c	246.9353	endl92	LLNL	<1992	300.0	19573	809	30.0	yes	both	no	no	no	
97249.60c	246.9400	endf60	B-VI:X-5	1986	293.6	50503	5268	20.0	no	both	no	no	no	
Z = 98 ***** Californium *****														
** Cf-249 **														
98249.35c	246.9352	endl85	LLNL	<1985	0.0	28055	2659	20.0	yes	pr	no	no	no	
98249.42c	246.9352	endl92	LLNL	<1992	300.0	49615	4554	30.0	yes	both	no	no	no	
98249.60c	246.9400	endf60	B-VI:X-5	1989	293.6	41271	4329	20	no	both	no	no	no	
98249.61c	246.9400	endf6dn	B-VI:X-5	1989	293.6	46154	4329	20.0	no	both	no	yes	no	
** Cf-250 **														
98250.35c	247.9281	endl85	LLNL	<1985	0.0	10487	457	20.0	yes	pr	no	no	no	
98250.42c	247.9281	endl92	LLNL	<1992	300.0	17659	574	30.0	yes	both	no	no	no	
98250.60c	247.9280	endf60	B-VI.2	1976	293.6	47758	5554	20.0	yes	tot	no	no	no	
** Cf-251 **														
98251.35c	248.9227	endl85	LLNL	<1985	0.0	10969	516	20.0	yes	pr	no	no	no	
98251.42c	248.9227	endl92	LLNL	<1992	300.0	17673	545	30.0	yes	both	no	no	no	
98251.60c	248.9230	endf60	B-VI.2	1976	293.6	42817	4226	20.0	yes	both	no	no	no	
98251.61c	248.9230	endf6dn	B-VI.2	1976	293.6	47715	4226	20.0	yes	both	no	yes	no	
** Cf-252 **														
98252.35c	249.9161	endl85	LLNL	<1985	0.0	17908	1535	20.0	yes	pr	no	no	no	
98252.42c	249.9161	endl92	LLNL	<1992	300.0	21027	1210	30.0	yes	both	no	no	no	
98252.60c	249.9160	endf60	B-VI.2	1976	293.6	49204	5250	20.0	yes	both	no	no	no	

**Not all libraries listed in this table are publically available.**

**APPENDIX G**  
**MCNP NEUTRON CROSS-SECTION LIBRARIES**

**SPECIAL NOTES**

- note 1. The data libraries previously known as EPRIXS and U600K are now a part of the data library ENDF5MT.
- note 2. Data translated to ENDF/B-VI format with some modifications by LANL.
- note 3. The 100XS data library contains data for 9 nuclides up to 100 MeV. Heating numbers on this data library are known to be incorrect, overestimating the energy deposition.<sup>4</sup>
- note 4. Photon production data were added to the existing ENDF evaluation in 1984. A complete new evaluation was performed in 1986.
- note 5. The natural carbon data 6000.50c are repeated here with the ZAIID of 6012.50c for the user's convenience. Both are based on the natural carbon ENDF/B-V.0 evaluation.
- note 6. The data libraries previously known as ARKRC, GDT2GP, IRNAT, MISCXS, TM169, and T2DDC are now a part of the data library MISC5XS.
- note 7. Photon production added to ENDF/B-V.0 neutron files by T-2, with the intent to estimate photon heating roughly.<sup>5</sup>
- note 8. These data were taken from incomplete fission-product evaluations.<sup>6</sup>
- note 9. This is ENDF/B-V.0 after modification by evaluator to get better agreement with ENDL85.<sup>7,8</sup>
- note 10. The following files for Zr have been replaced by the indicated ZAIID, eliminating the rare problem of having a secondary neutron energy greater than the incident neutron energy caused by an ENDF/B-V.0 evaluation problem.<sup>9</sup> Note that this correction has been made for the ENDF/B-VI evaluation.

40000.50c	rmccs	->	40000.56c	misc5xs
40000.50d	drmccs	->	40000.56d	misc5xs
40000.51c	endf5p	->	40000.57c	misc5xs
40000.51d	dre5	->	40000.57d	misc5xs
40000.53c	eprixs	->	40000.58c	misc5xs

- note 11. The ZAIIDs for ENDL-based average fission product data files have been changed for the latest library, ENDL92, to 49120.42c and 49125.42c. Z is now set to 49 to ensure that the appropriate atomic fraction and photon transport library is used. You may need to update the atomic weight ratio table in your XSDIR file to include these entries.<sup>10,11</sup> The ENDL92FP library is not publically available.
- note 12. The LANL/T-2 evaluation for I-127 was accepted for ENDF/B-VI.2 with modifications. These data are processed from the original LANL/T-2 evaluation.
- note 13. Photon production data for Gd were added to the ENDF/B-V.0 neutron cross sections by T-2. These data are valid only to 1 MeV.<sup>12</sup>
- note 14. Photon production data added to original evaluation in 1981 by LANL.
- note 15. The multitemperature data library ENDF62MT is still under development and is not publically available.<sup>13</sup>

#### IV. MULTIGROUP DATA FOR MCNP

Currently, only one coupled neutron-photon multigroup library is supported by X-5, MGXSNP.<sup>14</sup> MGXSNP is comprised of 30-group neutron and 12-group photon data primarily based on ENDF/B-V for 95 nuclides. The MCNP-compatible multigroup data library was produced from the original Sn multigroup libraries MENDF5 and MENDF5G using the code CRSRD in April 1987.<sup>15,16</sup> The original neutron data library MENDF5 was produced using the “TD-Division Weight Function,” also called “CLAW” by the processing code NJOY.<sup>17,18,19</sup> This weight function is a combination of a Maxwellian thermal + 1/E + fission + fusion peak at 14.0 MeV. The data library contains no upscatter groups or self-shielding, and is most applicable for fast systems. All cross-sections are for room temperature, 300°K. P0 through P4 scattering matrices from the original library were processed by CRSRD into angular distributions for MCNP using the Carter-Forest equiprobable bin treatment. When available, both total and prompt nubar data are provided. The edit reactions available for each ZAIID are fully described in reference 14.

TABLE G-3 describes the MGXSNP data library. The ZAIIDs used for this library correspond to the source evaluation in the same manner as the ZAIID for the continuous-energy and discrete data; as an example the same source evaluation for natural iron was used to produce 26000.55c, 26000.55d and 26000.55m. For coupled neutron-photon problems, specifying a particular isotope on a material card will invoke the neutron set for that isotope and the corresponding photon set for that element. For example, an entry of “1003” on a material card will cause MCNP to use ZAIID=1003.50m for neutron data and 1000.01g for photon data.

**TABLE G-3**  
**MGXSNP: A Coupled Neutron-Photon Multigroup Data Library**

<u>ZAIID</u>	<u>Neutron AWR</u>	<u>Length</u>	<u>ZAIID</u>	<u>Photon AWR</u>	<u>Length</u>
1001.50m	0.999172	3249	1000.01g	0.999317	583
1002.55m	1.996810	3542			
1003.50m	2.990154	1927			
2003.50m	2.990134	1843	2000.01g	3.968217	583
2004.50m	3.968238	1629			
3006.50m	5.963479	3566	3000.01g	6.881312	583
3007.55m	6.955768	3555			
4007.35m	6.949815	1598	4000.01g	8.934763	557
4009.50m	8.934807	3014			
5010.50m	9.926970	3557	5000.01g	10.717168	583
5011.56m	10.914679	2795			
6000.50m [1]	11.896972	2933	6000.01g	11.907955	583
6012.50m [1]	11.896972	2933			
7014.50m	13.882849	3501	7000.01g	13.886438	583

**APPENDIX G**  
**MULTIGROUP DATA FOR MCNP**

**TABLE G-3 (Cont.)**  
**MGXSNP: A Coupled Neutron-Photon Multigroup Data Library**

<u>ZAID</u>	<u>Neutron AWR</u>	<u>Length</u>	<u>ZAID</u>	<u>Photon AWR</u>	<u>Length</u>
7015.55m	14.871314	2743			
8016.50m	15.857588	3346	8000.01g	15.861942	583
9019.50m	18.835289	3261	9000.01g	18.835197	583
11023.50m	22.792388	2982	11000.01g	22.792275	583
12000.50m	24.096375	3802	12000.01g	24.096261	583
13027.50m	26.749887	3853	13000.01g	26.749756	583
14000.50m	27.844378	3266	14000.01g	27.844241	583
15031.50m	30.707833	2123	15000.01g	30.707682	583
16032.50m	31.697571	2185	16000.01g	31.788823	583
17000.50m	35.148355	2737	17000.01g	35.148180	583
18000.35m	39.605021	2022	18000.01g	39.604489	557
19000.50m	38.762616	2833	19000.01g	38.762423	583
20000.50m	39.734053	3450	20000.01g	39.733857	583
22000.50m	47.455981	3015	22000.01g	47.455747	583
23000.50m	50.504104	2775	23000.01g	50.503856	583
24000.50m	51.549511	3924	24000.01g	51.549253	583
25055.50m	54.466367	2890	25000.01g	54.466099	583
26000.55m	55.366734	4304	26000.01g	55.366466	583
27059.50m	58.427218	2889	27000.01g	58.426930	583
28000.50m	58.182926	3373	28000.01g	58.182641	583
29000.50m	62.999465	2803	29000.01g	62.999157	583
31000.50m	69.124611	2084	31000.01g	69.124270	583
33075.35m	74.278340	2022	33000.01g	74.277979	557
36078.50m	77.251400	2108	36000.01g	83.080137	583
36080.50m	79.230241	2257			
36082.50m	81.210203	2312			
36083.50m	82.202262	2141			
36084.50m	83.191072	2460			
36086.50m	85.173016	2413			
40000.50m	90.440039	2466	40000.01g	90.439594	583
41093.50m	92.108717	2746	41000.01g	92.108263	583
42000.50m	95.107162	1991	42000.01g	95.106691	583
45103.50m	102.021993	2147	45000.01g	102.021490	583
45117.90m	115.544386	2709			
46119.90m	117.525231	2629	46000.01g	105.513949	557
47000.55m	106.941883	2693	47000.01g	106.941685	583
47107.50m	105.987245	2107			
47109.50m	107.969736	1924			
48000.50m	111.442911	1841	48000.01g	111.442363	583
50120.35m	115.995479	1929	50000.01g	117.667336	557
50998.99m	228.025301	1382			
50999.99m	228.025301	1413			
54000.35m	130.171713	1929	54000.01g	130.165202	557
56138.50m	136.721230	2115	56000.01g	136.146809	583

**TABLE G-3 (Cont.)**  
**MGXSNP: A Coupled Neutron-Photon Multigroup Data Library**

<u>ZAID</u>	<u>Neutron AWR</u>	<u>Length</u>	<u>ZAID</u>	<u>Photon AWR</u>	<u>Length</u>
63000.35m	150.654333	1933	63000.01g	150.657141	557
63151.55m	149.623005	2976			
63153.55m	151.608005	2691			
64000.35m	155.898915	1929	64000.01g	155.900158	557
67165.55m	163.512997	2526	67000.01g	163.513493	583
73181.50m	179.394458	2787	73000.01g	179.393456	583
74000.55m	182.270446	4360	74000.01g	182.269548	583
74182.55m	180.386082	3687			
74183.55m	181.379499	3628			
74184.55m	182.371615	3664			
74186.55m	184.357838	3672			
75185.50m	183.365036	1968	75000.01g	184.607108	583
75187.50m	185.350629	2061			
78000.35m	193.415026	1929	78000.01g	193.404225	557
79197.56m	195.274027	3490	79000.01g	195.274513	583
82000.50m	205.437162	3384	82000.01g	205.436151	583
83209.50m	207.186158	2524	83000.01g	207.185136	583
90232.50m	230.045857	2896	90000.01g	230.044724	583
91233.50m	231.039442	1970	91000.01g	229.051160	479
92233.50m	231.038833	1988	92000.01g	235.984125	583
92234.50m	232.031554	2150			
92235.50m	233.025921	3164			
92236.50m	234.018959	2166			
92237.50m	235.013509	2174			
92238.50m	236.006966	3553			
92239.35m	236.997601	2147			
93237.55m	235.012957	2812	93000.01g	235.011799	479
94238.50m	236.005745	2442	94000.01g [2]	241.967559	583
94239.55m	236.999740	3038			
94240.50m	237.992791	3044			
94241.50m	238.987218	2856			
94242.50m	239.980508	2956			
95241.50m	238.987196	2535			
95242.50m	239.981303	2284			
95243.50m	240.974535	2480			
96242.50m	239.980599	1970			
96244.50m	241.967311	1950			

- note 1. The neutron transport data for ZAID's 6012.50m and 6000.50m are the same.  
note 2. Photon transport data are not provided for Z>94.

**APPENDIX G  
DOSIMETRY DATA FOR MCNP**

**V. DOSIMETRY DATA FOR MCNP**

The tally multiplier (FM) feature in MCNP allows users to calculate quantities of the form:  $C \int \phi(E) R(E) dE$ , where C is a constant,  $\phi(E)$  is the fluence ( $n/cm^2$ ), and R(E) is a response function. If R(E) is a cross section, and with the appropriate choice of units for C [atom/b-cm], the quantity calculated becomes the total number of some type of reaction per unit volume. If the tally is made over a finite time interval, it becomes a reaction rate per unit volume. In addition to using the standard reaction cross-section information available in our neutron transport libraries, dosimetry or activation reaction data may also be used as a response function. Often only dosimetry data is available for rare nuclides.

A full description of the use of dosimetry data can be found in reference 20. This memorandum also gives a listing of all reaction data that is available for each ZAID. There have been no major revisions of the LLNL/ACTL data since LLLDOS was produced. Users need to remember that dosimetry data libraries are appropriate only when used as a source of R(E) for FM tally multipliers. Dosimetry data libraries can not be used as a source of data for materials through which actual transport is required. TABLE G-4 lists the available dosimetry data libraries for use with MCNP, the evaluation source and date, and the length of the data in words.

**TABLE G-4  
Dosimetry Data Libraries for MCNP Tallies**

<b>ZAID</b>	<b>AWR</b>	<b>Library</b>	<b>Source</b>	<b>Date</b>	<b>Length</b>
<b>Z = 1 ***** Hydrogen *****</b>					
1001.30y	1.00782	lldos	LLNL/ACTL	<1983	209
1002.30y	2.01410	lldos	LLNL/ACTL	<1983	149
1003.30y	3.01605	lldos	LLNL/ACTL	<1983	27
<b>Z = 2 ***** Helium *****</b>					
2003.30y	3.01603	lldos	LLNL/ACTL	<1983	267
<b>Z = 3 ***** Lithium *****</b>					
3006.24y	5.96340	531dos	ENDF/B-V	1978	735
3006.26y	5.96340	532dos	ENDF/B-V	1977	713
3006.30y	6.01512	lldos	LLNL/ACTL	<1983	931
3007.26y	6.95570	532dos	ENDF/B-V	1972	733
3007.30y	7.01601	lldos	LLNL/ACTL	<1983	201
<b>Z = 4 ***** Beryllium *****</b>					
4007.30y	7.01693	lldos	LLNL/ACTL	<1983	253
4009.30y	9.01218	lldos	LLNL/ACTL	<1983	335
<b>Z = 5 ***** Boron *****</b>					

**TABLE G-4 (Cont.)  
Dosimetry Data Libraries for MCNP Tallies**

ZAID	AWR	Library	Source	Date	Length
5010.24y	9.92690	531dos	ENDF/B-V	1979	769
5010.26y	9.92690	532dos	ENDF/B-V	1976	589
5010.30y	10.01290	llldos	LLNL/ACTL	<1983	381
5011.30y	11.00930	llldos	LLNL/ACTL	<1983	119
Z = 6 ***** Carbon *****					
6012.30y	12.00000	llldos	LLNL/ACTL	<1983	97
6013.30y	13.00340	llldos	LLNL/ACTL	<1983	479
6014.30y	14.00320	llldos	LLNL/ACTL	<1983	63
Z = 7 ***** Nitrogen *****					
7014.26y	13.88300	532dos	ENDF/B-V	1973	1013
7014.30y	14.00310	llldos	LLNL/ACTL	<1983	915
Z = 8 ***** Oxygen *****					
8016.26y	15.85800	532dos	ENDF/B-V	1973	95
8016.30y	15.99490	llldos	LLNL/ACTL	<1983	215
8017.30y	16.99910	llldos	LLNL/ACTL	<1983	239
Z = 9 ***** Fluorine *****					
9019.26y	18.83500	532dos	ENDF/B-V	1979	31
9019.30y	18.99840	llldos	LLNL/ACTL	<1983	517
Z = 11 ***** Sodium *****					
11023.30y	22.98980	llldos	LLNL/ACTL	<1983	621
Z = 12 ***** Magnesium *****					
12023.30y	22.99410	llldos	LLNL/ACTL	<1983	333
12024.26y	23.98500	532dos	ENDF/B-V	1979	165
12024.30y	23.98500	llldos	LLNL/ACTL	<1983	309
12025.30y	24.98580	llldos	LLNL/ACTL	<1983	309
12026.30y	25.98260	llldos	LLNL/ACTL	<1983	321
12027.30y	26.98430	llldos	LLNL/ACTL	<1983	309
Z = 13 ***** Aluminum *****					
13026.30y	25.98690	llldos	LLNL/ACTL	<1983	447
13027.24y	26.75000	531dos	ENDF/B-V	1973	1165
13027.26y	26.75000	532dos	ENDF/B-V	1973	1753
13027.30y	26.98150	llldos	LLNL/ACTL	<1983	491

**APPENDIX G  
DOSIMETRY DATA FOR MCNP**

**TABLE G-4 (Cont.)  
Dosimetry Data Libraries for MCNP Tallies**

<b>ZAID</b>	<b>AWR</b>	<b>Library</b>	<b>Source</b>	<b>Date</b>	<b>Length</b>
<b>Z = 14 ***** Silicon *****</b>					
14027.30y	26.98670	lldos	LLNL/ACTL	<1983	401
14028.30y	27.97690	lldos	LLNL/ACTL	<1983	377
14029.30y	28.97650	lldos	LLNL/ACTL	<1983	389
14030.30y	29.97380	lldos	LLNL/ACTL	<1983	395
14031.30y	30.97540	lldos	LLNL/ACTL	<1983	337
<b>Z = 15 ***** Phosphorus *****</b>					
15031.26y	30.70800	532dos	ENDF/B-V	1977	65
15031.30y	30.97380	lldos	LLNL/ACTL	<1983	263
<b>Z = 16 ***** Sulfur *****</b>					
16031.30y	30.97960	lldos	LLNL/ACTL	<1983	393
16032.24y	31.69740	531dos	ENDF/B-V	1979	145
16032.26y	31.69700	532dos	ENDF/B-V	1977	35
16032.30y	31.97210	lldos	LLNL/ACTL	<1983	417
16033.30y	32.97150	lldos	LLNL/ACTL	<1983	435
16034.30y	33.96790	lldos	LLNL/ACTL	<1983	437
16035.30y	34.96900	lldos	LLNL/ACTL	<1983	339
16036.30y	35.96710	lldos	LLNL/ACTL	<1983	293
16037.30y	36.97110	lldos	LLNL/ACTL	<1983	279
<b>Z = 17 ***** Chlorine *****</b>					
17034.30y	33.97380	lldos	LLNL/ACTL	<1983	401
17035.30y	34.96890	lldos	LLNL/ACTL	<1983	459
17036.30y	35.96830	lldos	LLNL/ACTL	<1983	563
17037.30y	36.96590	lldos	LLNL/ACTL	<1983	407
7038.30y	37.96800	lldos	LLNL/ACTL	<1983	33
<b>Z = 18 ***** Argon *****</b>					
18036.30y	35.96750	lldos	LLNL/ACTL	<1983	309
18037.30y	36.96680	lldos	LLNL/ACTL	<1983	311
18038.30y	37.96270	lldos	LLNL/ACTL	<1983	311
18039.30y	38.96430	lldos	LLNL/ACTL	<1983	337
18040.26y	39.61910	532dos	ENDF/B-V	1979	3861
18040.30y	39.96240	lldos	LLNL/ACTL	<1983	347
18041.30y	40.96450	lldos	LLNL/ACTL	<1983	317
18042.30y	41.96300	lldos	LLNL/ACTL	<1983	291
18043.30y	42.96570	lldos	LLNL/ACTL	<1983	295
<b>Z = 19 ***** Potassium *****</b>					
19038.30y	37.96910	lldos	LLNL/ACTL	<1983	603
19039.30y	38.96370	lldos	LLNL/ACTL	<1983	405



**TABLE G-4 (Cont.)**  
**Dosimetry Data Libraries for MCNP Tallies**

ZAID	AWR	Library	Source	Date	Length
19040.30y	39.96400	lldos	LLNL/ACTL	<1983	675
19041.26y	40.60990	532dos	ENDF/B-V	1979	33
19041.30y	40.96180	lldos	LLNL/ACTL	<1983	369
19042.30y	41.96240	lldos	LLNL/ACTL	<1983	343
19043.30y	42.96070	lldos	LLNL/ACTL	<1983	277
19044.30y	43.96160	lldos	LLNL/ACTL	<1983	275
19045.30y	44.96070	lldos	LLNL/ACTL	<1983	283
19046.30y	45.96200	lldos	LLNL/ACTL	<1983	283
Z = 20 ***** Calcium *****					
20039.30y	38.97070	lldos	LLNL/ACTL	<1983	601
20040.30y	39.96260	lldos	LLNL/ACTL	<1983	309
20041.30y	40.96230	lldos	LLNL/ACTL	<1983	313
20042.30y	41.95860	lldos	LLNL/ACTL	<1983	285
20043.30y	42.95880	lldos	LLNL/ACTL	<1983	295
20044.30y	43.95550	lldos	LLNL/ACTL	<1983	269
20045.30y	44.95620	lldos	LLNL/ACTL	<1983	271
20046.30y	45.95370	lldos	LLNL/ACTL	<1983	255
20047.30y	46.95450	lldos	LLNL/ACTL	<1983	243
20048.30y	47.95250	lldos	LLNL/ACTL	<1983	239
20049.30y	48.95570	lldos	LLNL/ACTL	<1983	229
Z = 21 ***** Scandium *****					
21044.30y	43.95940	lldos	LLNL/ACTL	<1983	313
21044.31y	43.95940	lldos	LLNL/ACTL	<1983	311
21045.24y	44.56790	531dos	ENDF/B-V	1979	20179
21045.26y	44.56790	532dos	ENDF/B-V	1979	20211
21045.30y	44.95590	lldos	LLNL/ACTL	<1983	547
21046.30y	45.95520	lldos	LLNL/ACTL	<1983	323
21046.31y	45.95520	lldos	LLNL/ACTL	<1983	323
21047.30y	46.95240	lldos	LLNL/ACTL	<1983	331
21048.30y	47.95220	lldos	LLNL/ACTL	<1983	325
Z = 22 ***** Titanium *****					
22045.30y	44.95810	lldos	LLNL/ACTL	<1983	449
22046.24y	45.55780	531dos	ENDF/B-V	1977	53
22046.26y	45.55780	532dos	ENDF/B-V	1977	53
22046.30y	45.95260	lldos	LLNL/ACTL	<1983	391
22047.24y	46.54800	531dos	ENDF/B-V	1977	209
22047.26y	46.54800	532dos	ENDF/B-V	1977	209
22047.30y	46.95180	lldos	LLNL/ACTL	<1983	419
22048.24y	47.53600	531dos	ENDF/B-V	1977	145
22048.26y	47.53600	532dos	ENDF/B-V	1977	177
22048.30y	47.94790	lldos	LLNL/ACTL	<1983	415
22049.30y	48.94790	lldos	LLNL/ACTL	<1983	409
22050.26y	49.57000	532dos	ENDF/B-V	1979	33

**APPENDIX G  
DOSIMETRY DATA FOR MCNP**

**TABLE G-4 (Cont.)  
Dosimetry Data Libraries for MCNP Tallies**

<b>ZAID</b>	<b>AWR</b>	<b>Library</b>	<b>Source</b>	<b>Date</b>	<b>Length</b>
22050.30y	49.94480	lldos	LLNL/ACTL	<1983	345
22051.30y	50.94660	lldos	LLNL/ACTL	<1983	389
Z = 23 ***** Vanadium *****					
23047.30y	46.95490	lldos	LLNL/ACTL	<1983	209
23048.30y	47.95230	lldos	LLNL/ACTL	<1983	399
23049.30y	48.94850	lldos	LLNL/ACTL	<1983	423
23050.30y	49.94720	lldos	LLNL/ACTL	<1983	407
23051.30y	50.94400	lldos	LLNL/ACTL	<1983	357
23052.30y	51.94480	lldos	LLNL/ACTL	<1983	401
Z = 24 ***** Chromium *****					
24049.30y	48.95130	lldos	LLNL/ACTL	<1983	377
24050.26y	49.51650	532dos	ENDF/B-V	1979	7405
24050.30y	49.94600	lldos	LLNL/ACTL	<1983	435
24051.30y	50.94480	lldos	LLNL/ACTL	<1983	377
24052.26y	51.49380	532dos	ENDF/B-V	1979	27
24052.30y	51.94050	lldos	LLNL/ACTL	<1983	417
24053.30y	52.94060	lldos	LLNL/ACTL	<1983	425
24054.30y	53.93890	lldos	LLNL/ACTL	<1983	461
24055.30y	54.94080	lldos	LLNL/ACTL	<1983	419
24056.30y	55.94070	lldos	LLNL/ACTL	<1983	297
Z = 25 ***** Manganese *****					
25051.30y	50.94820	lldos	LLNL/ACTL	<1983	417
25052.30y	51.94560	lldos	LLNL/ACTL	<1983	379
25053.30y	52.94130	lldos	LLNL/ACTL	<1983	425
25054.30y	53.94040	lldos	LLNL/ACTL	<1983	391
25055.24y	54.46610	531dos	ENDF/B-V	1977	119
25055.30y	54.93800	lldos	LLNL/ACTL	<1983	435
25056.30y	55.93890	lldos	LLNL/ACTL	<1983	423
25057.30y	56.93830	lldos	LLNL/ACTL	<1983	419
25058.30y	57.93970	lldos	LLNL/ACTL	<1983	285
Z = 26 ***** Iron *****					
26053.30y	52.94530	lldos	LLNL/ACTL	<1983	387
26054.24y	53.47620	531dos	ENDF/B-V	1979	517
26054.26y	53.47600	532dos	ENDF/B-V	1978	21563
26054.30y	53.93960	lldos	LLNL/ACTL	<1983	457
26055.30y	54.93830	lldos	LLNL/ACTL	<1983	373
26056.24y	55.45400	531dos	ENDF/B-V	1978	449
26056.26y	55.45400	532dos	ENDF/B-V	1978	581
26056.30y	55.93490	lldos	LLNL/ACTL	<1983	415
26057.30y	56.93540	lldos	LLNL/ACTL	<1983	447
26058.24y	57.43560	531dos	ENDF/B-V	1979	7077

**TABLE G-4 (Cont.)**  
**Dosimetry Data Libraries for MCNP Tallies**

ZAID	AWR	Library	Source	Date	Length
26058.26y	57.43560	532dos	ENDF/B-V	1979	7097
26058.30y	57.93330	lldos	LLNL/ACTL	<1983	431
26059.30y	58.93490	lldos	LLNL/ACTL	<1983	397
26060.30y	59.93400	lldos	LLNL/ACTL	<1983	285
Z = 27 ***** Cobalt *****					
27057.30y	56.93630	lldos	LLNL/ACTL	<1983	629
27058.30y	57.93580	lldos	LLNL/ACTL	<1983	531
27058.31y	57.93580	lldos	LLNL/ACTL	<1983	569
27059.30y	58.93320	lldos	LLNL/ACTL	<1983	657
27060.30y	59.93380	lldos	LLNL/ACTL	<1983	435
27060.31y	59.93380	lldos	LLNL/ACTL	<1983	499
27061.30y	60.93250	lldos	LLNL/ACTL	<1983	613
27062.30y	61.93400	lldos	LLNL/ACTL	<1983	463
27062.31y	61.93400	lldos	LLNL/ACTL	<1983	519
27063.30y	62.93360	lldos	LLNL/ACTL	<1983	339
27064.30y	63.93580	lldos	LLNL/ACTL	<1983	323
Z = 28 ***** Nickel *****					
28057.30y	56.93980	lldos	LLNL/ACTL	<1983	441
28058.24y	57.43760	531dos	ENDF/B-V	1977	411
28058.26y	57.43760	532dos	ENDF/B-V	1978	4079
28058.30y	57.93530	lldos	LLNL/ACTL	<1983	509
28059.30y	58.93430	lldos	LLNL/ACTL	<1983	513
28060.24y	59.41590	531dos	ENDF/B-V	1977	435
28060.26y	59.41590	532dos	ENDF/B-V	1978	479
28060.30y	59.93080	lldos	LLNL/ACTL	<1983	503
28061.30y	60.93110	lldos	LLNL/ACTL	<1983	489
28062.26y	61.39630	532dos	ENDF/B-V	1978	3847
8062.30y	61.92830	lldos	LLNL/ACTL	<1983	459
28063.30y	62.92970	lldos	LLNL/ACTL	<1983	375
28064.30y	63.92800	lldos	LLNL/ACTL	<1983	397
28065.30y	64.93010	lldos	LLNL/ACTL	<1983	345
Z = 29 ***** Copper *****					
29062.30y	61.93260	lldos	LLNL/ACTL	<1983	507
29063.24y	62.93000	531dos	ENDF/B-V	1978	3375
29063.26y	62.93000	532dos	ENDF/B-V	1978	3615
29063.30y	62.92960	lldos	LLNL/ACTL	<1983	513
29064.30y	63.92980	lldos	LLNL/ACTL	<1983	437
29065.24y	64.92800	531dos	ENDF/B-V	1978	49
29065.26y	64.92800	532dos	ENDF/B-V	1978	49
29065.30y	64.92780	lldos	LLNL/ACTL	<1983	563
29066.30y	65.92890	lldos	LLNL/ACTL	<1983	397
Z = 30 ***** Zinc *****					

**APPENDIX G  
DOSIMETRY DATA FOR MCNP**

**TABLE G-4 (Cont.)  
Dosimetry Data Libraries for MCNP Tallies**

<b>ZAID</b>	<b>AWR</b>	<b>Library</b>	<b>Source</b>	<b>Date</b>	<b>Length</b>
30064.30y	63.92910	lldos	LLNL/ACTL	<1983	555
30066.30y	65.92600	lldos	LLNL/ACTL	<1983	561
30067.30y	66.92710	lldos	LLNL/ACTL	<1983	411
30068.30y	67.92480	lldos	LLNL/ACTL	<1983	643
30070.30y	69.92530	lldos	LLNL/ACTL	<1983	619
Z = 31 ***** Gallium *****					
31069.30y	68.92560	lldos	LLNL/ACTL	<1983	197
31071.30y	70.92470	lldos	LLNL/ACTL	<1983	419
Z = 32 ***** Germanium *****					
32070.30y	69.92420	lldos	LLNL/ACTL	<1983	405
32072.30y	71.92210	lldos	LLNL/ACTL	<1983	423
32073.30y	72.92350	lldos	LLNL/ACTL	<1983	431
32074.30y	73.92120	lldos	LLNL/ACTL	<1983	629
32076.30y	75.92140	lldos	LLNL/ACTL	<1983	623
Z = 33 ***** Arsenic *****					
33075.30y	74.92160	lldos	LLNL/ACTL	<1983	987
Z = 34 ***** Selenium *****					
34074.30y	73.92250	lldos	LLNL/ACTL	<1983	159
34076.30y	75.91920	lldos	LLNL/ACTL	<1983	177
34080.30y	79.91650	lldos	LLNL/ACTL	<1983	205
34082.30y	81.91670	lldos	LLNL/ACTL	<1983	223
Z = 35 ***** Bromine *****					
35079.30y	78.91830	lldos	LLNL/ACTL	<1983	263
35081.30y	80.91630	lldos	LLNL/ACTL	<1983	695
Z = 37 ***** Rubidium *****					
37085.30y	84.91180	lldos	LLNL/ACTL	<1983	193
37087.30y	86.90920	lldos	LLNL/ACTL	<1983	199
Z = 38 ***** Strontium *****					
38084.30y	83.91340	lldos	LLNL/ACTL	<1983	163
38086.30y	85.90930	lldos	LLNL/ACTL	<1983	33
Z = 39 ***** Yttrium *****					
39089.30y	88.90590	lldos	LLNL/ACTL	<1983	419

**TABLE G-4 (Cont.)**  
**Dosimetry Data Libraries for MCNP Tallies**

ZAID	AWR	Library	Source	Date	Length
Z = 40 ***** Zirconium *****					
40089.30y	88.90890	llldos	LLNL/ACTL	<1983	321
40090.26y	89.13200	532dos	ENDF/B-V	1976	37
40090.30y	89.90470	llldos	LLNL/ACTL	<1983	385
40091.30y	90.90560	llldos	LLNL/ACTL	<1983	407
40092.26y	91.11200	532dos	ENDF/B-V	1976	3821
40092.30y	91.90500	llldos	LLNL/ACTL	<1983	431
40093.30y	92.90650	llldos	LLNL/ACTL	<1983	371
40094.26y	93.09600	532dos	ENDF/B-V	1976	5255
40094.30y	93.90630	llldos	LLNL/ACTL	<1983	417
40095.30y	94.90800	llldos	LLNL/ACTL	<1983	375
40096.30y	95.90830	llldos	LLNL/ACTL	<1983	57
40097.30y	96.91090	llldos	LLNL/ACTL	<1983	339
Z = 41 ***** Niobium *****					
41091.30y	90.90700	llldos	LLNL/ACTL	<1983	491
41091.31y	90.90700	llldos	LLNL/ACTL	<1983	491
41092.30y	91.90720	llldos	LLNL/ACTL	<1983	285
41092.31y	91.90720	llldos	LLNL/ACTL	<1983	285
41093.30y	92.90640	llldos	LLNL/ACTL	<1983	493
41094.30y	93.90730	llldos	LLNL/ACTL	<1983	331
41095.30y	94.90680	llldos	LLNL/ACTL	<1983	333
41096.30y	95.90810	llldos	LLNL/ACTL	<1983	335
41097.30y	96.90810	llldos	LLNL/ACTL	<1983	339
41098.30y	97.91030	llldos	LLNL/ACTL	<1983	341
41100.30y	99.91420	llldos	LLNL/ACTL	<1983	349
Z = 42 ***** Molybdenum *****					
42090.30y	89.91390	llldos	LLNL/ACTL	<1983	261
42091.30y	90.91180	llldos	LLNL/ACTL	<1983	281
42092.26y	91.21000	532dos	ENDF/B-V	1980	7815
42092.30y	91.90680	llldos	LLNL/ACTL	<1983	537
42093.30y	92.90680	llldos	LLNL/ACTL	<1983	429
42093.31y	92.90680	llldos	LLNL/ACTL	<1983	461
42094.30y	93.90510	llldos	LLNL/ACTL	<1983	443
42095.30y	94.90580	llldos	LLNL/ACTL	<1983	523
42096.30y	95.90470	llldos	LLNL/ACTL	<1983	501
42097.30y	96.90600	llldos	LLNL/ACTL	<1983	427
42098.26y	97.06440	532dos	ENDF/B-V	1980	6489
42098.30y	97.90540	llldos	LLNL/ACTL	<1983	421
42099.30y	98.90770	llldos	LLNL/ACTL	<1983	445
42100.26y	99.04920	532dos	ENDF/B-V	1980	4971
42100.30y	99.90750	llldos	LLNL/ACTL	<1983	427
42101.30y	100.91000	llldos	LLNL/ACTL	<1983	447

**APPENDIX G  
DOSIMETRY DATA FOR MCNP**

**TABLE G-4 (Cont.)  
Dosimetry Data Libraries for MCNP Tallies**

<b>ZAID</b>	<b>AWR</b>	<b>Library</b>	<b>Source</b>	<b>Date</b>	<b>Length</b>
Z = 43 ***** Technetium *****					
43099.30y	98.90620	lldos	LLNL/ACTL	<1983	469
43099.31y	98.90620	lldos	LLNL/ACTL	<1983	469
Z = 45 ***** Rhodium *****					
45103.30y	102.90600	lldos	LLNL/ACTL	<1983	275
Z = 46 ***** Palladium *****					
46110.30y	109.90500	lldos	LLNL/ACTL	<1983	417
Z = 47 ***** Silver *****					
47106.30y	105.90700	lldos	LLNL/ACTL	<1983	263
47106.31y	105.90700	lldos	LLNL/ACTL	<1983	265
47107.30y	106.90500	lldos	LLNL/ACTL	<1983	517
47108.30y	107.90600	lldos	LLNL/ACTL	<1983	275
47108.31y	107.90600	lldos	LLNL/ACTL	<1983	275
47109.30y	108.90500	lldos	LLNL/ACTL	<1983	583
47110.30y	109.90600	lldos	LLNL/ACTL	<1983	277
47110.31y	109.90600	lldos	LLNL/ACTL	<1983	281
Z = 48 ***** Cadmium *****					
48106.30y	105.90600	lldos	LLNL/ACTL	<1983	177
48111.30y	110.90400	lldos	LLNL/ACTL	<1983	317
48112.30y	111.90300	lldos	LLNL/ACTL	<1983	221
48116.30y	115.90500	lldos	LLNL/ACTL	<1983	231
Z = 49 ***** Indium *****					
49113.30y	112.90400	lldos	LLNL/ACTL	<1983	861
49115.24y	113.92000	531dos	ENDF/B-V	1978	26009
49115.26y	113.92000	532dos	ENDF/B-V	1978	26009
49115.30y	114.90400	lldos	LLNL/ACTL	<1983	1265
Z = 50 ***** Tin *****					
50112.30y	111.90500	lldos	LLNL/ACTL	<1983	789
50114.30y	113.90300	lldos	LLNL/ACTL	<1983	435
50115.30y	114.90300	lldos	LLNL/ACTL	<1983	389
50116.30y	115.90200	lldos	LLNL/ACTL	<1983	603
50117.30y	116.90300	lldos	LLNL/ACTL	<1983	313
50118.30y	117.90200	lldos	LLNL/ACTL	<1983	745
50119.30y	118.90300	lldos	LLNL/ACTL	<1983	311
50120.26y	118.87200	532dos	ENDF/B-V	1974	12881
50120.30y	119.90200	lldos	LLNL/ACTL	<1983	309

**TABLE G-4 (Cont.)  
Dosimetry Data Libraries for MCNP Tallies**

ZAID	AWR	Library	Source	Date	Length
50122.26y	120.85600	532dos	ENDF/B-V	1974	1891
50122.30y	121.90300	lldos	LLNL/ACTL	<1983	275
50124.26y	122.84100	532dos	ENDF/B-V	1974	1693
50124.30y	123.90500	lldos	LLNL/ACTL	<1983	485
Z = 51 ***** Antimony *****					
51121.30y	120.90400	lldos	LLNL/ACTL	<1983	811
51123.30y	122.90400	lldos	LLNL/ACTL	<1983	1013
Z = 53 ***** Iodine *****					
53127.24y	125.81400	531dos	ENDF/B-V	1972	115
53127.26y	125.81400	532dos	ENDF/B-V	1980	14145
53127.30y	126.90400	lldos	LLNL/ACTL	<1983	221
Z = 55 ***** Cesium *****					
55133.30y	132.90500	lldos	LLNL/ACTL	<1983	215
Z = 57 ***** Lanthanum *****					
57139.26y	137.71300	532dos	ENDF/B-V	1980	15475
Z = 58 ***** Cerium *****					
58140.30y	139.90500	lldos	LLNL/ACTL	<1983	427
58142.30y	141.90900	lldos	LLNL/ACTL	<1983	265
Z = 59 ***** Praseodymium *****					
59141.30y	140.90800	lldos	LLNL/ACTL	<1983	215
Z = 60 ***** Neodymium *****					
60142.30y	141.90800	lldos	LLNL/ACTL	<1983	207
60148.30y	147.91700	lldos	LLNL/ACTL	<1983	255
60150.30y	149.92100	lldos	LLNL/ACTL	<1983	259
Z = 62 ***** Samarium *****					
62144.30y	143.91200	lldos	LLNL/ACTL	<1983	189
62148.30y	147.91500	lldos	LLNL/ACTL	<1983	245
62152.30y	151.92000	lldos	LLNL/ACTL	<1983	237
62154.30y	153.92200	lldos	LLNL/ACTL	<1983	247
Z = 63 ***** Europium *****					
63151.30y	150.92000	lldos	LLNL/ACTL	<1983	731

**APPENDIX G  
DOSIMETRY DATA FOR MCNP**

**TABLE G-4 (Cont.)  
Dosimetry Data Libraries for MCNP Tallies**

<b>ZAID</b>	<b>AWR</b>	<b>Library</b>	<b>Source</b>	<b>Date</b>	<b>Length</b>
63153.30y	152.92100	lldos	LLNL/ACTL	<1983	565
Z = 64 ***** Gadolinium *****					
64150.30y	149.91900	lldos	LLNL/ACTL	<1983	237
64151.30y	150.92000	lldos	LLNL/ACTL	<1983	241
Z = 66 ***** Dysprosium *****					
66164.26y	162.52000	532dos	ENDF/B-V	1967	581
Z = 67 ***** Holmium *****					
67163.30y	162.92900	lldos	LLNL/ACTL	<1983	533
67164.30y	163.93000	lldos	LLNL/ACTL	<1983	327
67164.31y	163.93000	lldos	LLNL/ACTL	<1983	327
67165.30y	164.93000	lldos	LLNL/ACTL	<1983	589
67166.30y	165.93200	lldos	LLNL/ACTL	<1983	333
67166.31y	165.93200	lldos	LLNL/ACTL	<1983	333
Z = 69 ***** Thulium *****					
69169.30y	168.93400	lldos	LLNL/ACTL	<1983	453
Z = 71 ***** Lutetium *****					
71173.30y	172.93900	lldos	LLNL/ACTL	<1983	587
71174.30y	173.94000	lldos	LLNL/ACTL	<1983	417
71174.31y	173.94000	lldos	LLNL/ACTL	<1983	465
71175.30y	174.94100	lldos	LLNL/ACTL	<1983	559
71176.30y	175.94300	lldos	LLNL/ACTL	<1983	621
71176.31y	175.94300	lldos	LLNL/ACTL	<1983	637
71177.30y	176.94400	lldos	LLNL/ACTL	<1983	573
71177.31y	176.94400	lldos	LLNL/ACTL	<1983	573
Z = 72 ***** Hafnium *****					
72174.30y	173.94000	lldos	LLNL/ACTL	<1983	147
72175.30y	174.94100	lldos	LLNL/ACTL	<1983	121
72176.30y	175.94100	lldos	LLNL/ACTL	<1983	153
72177.30y	176.94300	lldos	LLNL/ACTL	<1983	157
72178.30y	177.94400	lldos	LLNL/ACTL	<1983	153
72179.30y	178.94600	lldos	LLNL/ACTL	<1983	433
72180.30y	179.94700	lldos	LLNL/ACTL	<1983	409
72181.30y	180.94900	lldos	LLNL/ACTL	<1983	365
72183.30y	182.95400	lldos	LLNL/ACTL	<1983	373
Z = 73 ***** Tantalum *****					



**TABLE G-4 (Cont.)**  
**Dosimetry Data Libraries for MCNP Tallies**

ZAID	AWR	Library	Source	Date	Length
73179.30y	178.94600	lldos	LLNL/ACTL	<1983	629
73180.30y	179.94700	lldos	LLNL/ACTL	<1983	523
73180.31y	179.94700	lldos	LLNL/ACTL	<1983	435
73181.30y	180.94800	lldos	LLNL/ACTL	<1983	715
73182.30y	181.95000	lldos	LLNL/ACTL	<1983	435
73182.31y	181.95000	lldos	LLNL/ACTL	<1983	447
73183.30y	182.95100	lldos	LLNL/ACTL	<1983	425
73184.30y	183.95400	lldos	LLNL/ACTL	<1983	371
73186.30y	185.95900	lldos	LLNL/ACTL	<1983	377
<b>Z = 74 ***** Tungsten *****</b>					
74179.30y	178.94700	lldos	LLNL/ACTL	<1983	263
74180.30y	179.94700	lldos	LLNL/ACTL	<1983	397
74181.30y	180.94800	lldos	LLNL/ACTL	<1983	263
74182.30y	181.94800	lldos	LLNL/ACTL	<1983	415
74183.30y	182.95000	lldos	LLNL/ACTL	<1983	499
74184.30y	183.95100	lldos	LLNL/ACTL	<1983	443
74185.30y	184.95300	lldos	LLNL/ACTL	<1983	267
74186.30y	185.95400	lldos	LLNL/ACTL	<1983	413
74187.30y	186.95700	lldos	LLNL/ACTL	<1983	279
74188.30y	187.95800	lldos	LLNL/ACTL	<1983	271
<b>Z = 75 ***** Rhenium *****</b>					
75184.30y	183.95300	lldos	LLNL/ACTL	<1983	331
75184.31y	183.95300	lldos	LLNL/ACTL	<1983	335
75185.30y	184.95300	lldos	LLNL/ACTL	<1983	373
75186.30y	185.95500	lldos	LLNL/ACTL	<1983	381
75187.30y	186.95600	lldos	LLNL/ACTL	<1983	547
75188.30y	187.95800	lldos	LLNL/ACTL	<1983	339
75188.31y	187.95800	lldos	LLNL/ACTL	<1983	341
<b>Z = 77 ***** Iridium *****</b>					
77191.30y	190.96100	lldos	LLNL/ACTL	<1983	237
77193.30y	192.96300	lldos	LLNL/ACTL	<1983	243
77194.30y	193.96500	lldos	LLNL/ACTL	<1983	421
<b>Z = 78 ***** Platinum *****</b>					
78190.30y	189.96000	lldos	LLNL/ACTL	<1983	151
78192.30y	191.96100	lldos	LLNL/ACTL	<1983	153
78193.30y	192.96300	lldos	LLNL/ACTL	<1983	123
78193.31y	192.96300	lldos	LLNL/ACTL	<1983	123
78194.30y	193.96300	lldos	LLNL/ACTL	<1983	211
78195.30y	194.96500	lldos	LLNL/ACTL	<1983	157
78196.30y	195.96500	lldos	LLNL/ACTL	<1983	157
78197.30y	196.96700	lldos	LLNL/ACTL	<1983	427

**APPENDIX G  
DOSIMETRY DATA FOR MCNP**

**TABLE G-4 (Cont.)  
Dosimetry Data Libraries for MCNP Tallies**

<b>ZAID</b>	<b>AWR</b>	<b>Library</b>	<b>Source</b>	<b>Date</b>	<b>Length</b>
78197.31y	196.96700	lldos	LLNL/ACTL	<1983	129
78198.30y	197.96800	lldos	LLNL/ACTL	<1983	183
78199.30y	198.97100	lldos	LLNL/ACTL	<1983	99
78199.31y	198.97100	lldos	LLNL/ACTL	<1983	99
<b>Z = 79 ***** Gold *****</b>					
79193.30y	192.96400	lldos	LLNL/ACTL	<1983	209
79194.30y	193.96500	lldos	LLNL/ACTL	<1983	261
79195.30y	194.96500	lldos	LLNL/ACTL	<1983	261
79196.30y	195.96700	lldos	LLNL/ACTL	<1983	265
79196.31y	195.96700	lldos	LLNL/ACTL	<1983	265
79197.30y	196.96700	lldos	LLNL/ACTL	<1983	307
79198.30y	197.96800	lldos	LLNL/ACTL	<1983	265
79199.30y	198.96900	lldos	LLNL/ACTL	<1983	269
79200.30y	199.97100	lldos	LLNL/ACTL	<1983	39
<b>Z = 80 ***** Mercury *****</b>					
80202.30y	201.97100	lldos	LLNL/ACTL	<1983	381
80203.30y	202.97300	lldos	LLNL/ACTL	<1983	379
80204.30y	203.97300	lldos	LLNL/ACTL	<1983	365
<b>Z = 81 ***** Thallium *****</b>					
81202.30y	201.97200	lldos	LLNL/ACTL	<1983	377
81203.30y	202.97200	lldos	LLNL/ACTL	<1983	375
81204.30y	203.97400	lldos	LLNL/ACTL	<1983	373
81205.30y	204.97400	lldos	LLNL/ACTL	<1983	369
<b>Z = 82 ***** Lead *****</b>					
82203.30y	202.97300	lldos	LLNL/ACTL	<1983	257
82204.30y	203.97300	lldos	LLNL/ACTL	<1983	405
82205.30y	204.97400	lldos	LLNL/ACTL	<1983	257
82206.30y	205.97400	lldos	LLNL/ACTL	<1983	347
82207.30y	206.97600	lldos	LLNL/ACTL	<1983	333
82208.30y	207.97700	lldos	LLNL/ACTL	<1983	263
82209.30y	208.98100	lldos	LLNL/ACTL	<1983	279
82210.30y	209.98400	lldos	LLNL/ACTL	<1983	351
<b>Z = 83 ***** Bismuth *****</b>					
83208.30y	207.98000	lldos	LLNL/ACTL	<1983	409
83209.30y	208.98000	lldos	LLNL/ACTL	<1983	551
83210.30y	209.98400	lldos	LLNL/ACTL	<1983	421
83210.31y	209.98400	lldos	LLNL/ACTL	<1983	421

**TABLE G-4 (Cont.)**  
**Dosimetry Data Libraries for MCNP Tallies**

ZAID	AWR	Library	Source	Date	Length
Z = 84 ***** Polonium *****					
84210.30y	209.98300	lldos	LLNL/ACTL	<1983	441
Z = 90 ***** Thorium *****					
90230.30y	230.03300	lldos	LLNL/ACTL	<1983	209
90231.30y	231.03600	lldos	LLNL/ACTL	<1983	599
90232.30y	232.03800	lldos	LLNL/ACTL	<1983	347
90233.30y	233.04200	lldos	LLNL/ACTL	<1983	561
90234.30y	234.04400	lldos	LLNL/ACTL	<1983	37
Z = 91 ***** Protactinium *****					
91231.26y	229.05000	532dos	ENDF/B-V	1978	2861
91233.26y	231.03800	532dos	ENDF/B-V	1978	73
91233.30y	233.04000	lldos	LLNL/ACTL	<1983	361
Z = 92 ***** Uranium *****					
92233.26y	231.04300	532dos	ENDF/B-V	1978	75
92233.30y	233.04000	lldos	LLNL/ACTL	<1983	461
92234.30y	234.04100	lldos	LLNL/ACTL	<1983	393
92235.30y	235.04400	lldos	LLNL/ACTL	<1983	4629
92236.30y	236.04600	lldos	LLNL/ACTL	<1983	395
92237.30y	237.04900	lldos	LLNL/ACTL	<1983	609
92238.30y	238.05100	lldos	LLNL/ACTL	<1983	3103
92239.30y	239.05400	lldos	LLNL/ACTL	<1983	825
92240.30y	240.05700	lldos	LLNL/ACTL	<1983	389
Z = 93 ***** Neptunium *****					
93237.30y	237.04800	lldos	LLNL/ACTL	<1983	629
Z = 94 ***** Plutonium *****					
94237.30y	237.04800	lldos	LLNL/ACTL	<1983	487
94238.30y	238.05000	lldos	LLNL/ACTL	<1983	459
94239.30y	239.05200	lldos	LLNL/ACTL	<1983	497
94240.30y	240.05400	lldos	LLNL/ACTL	<1983	479
94241.30y	241.05700	lldos	LLNL/ACTL	<1983	559
94242.30y	242.05900	lldos	LLNL/ACTL	<1983	505
94243.30y	243.06200	lldos	LLNL/ACTL	<1983	511
Z = 95 ***** Americium *****					
95241.30y	241.05700	lldos	LLNL/ACTL	<1983	673
95242.30y	242.06000	lldos	LLNL/ACTL	<1983	473
95243.30y	243.06100	lldos	LLNL/ACTL	<1983	431

**APPENDIX G  
REFERENCES**

**TABLE G-4 (Cont.)  
Dosimetry Data Libraries for MCNP Tallies**

<b>ZAID</b>	<b>AWR</b>	<b>Library</b>	<b>Source</b>	<b>Date</b>	<b>Length</b>
Z = 96 ***** Curium *****					
96242.30y	242.05900	lldos	LLNL/ACTL	<1983	467
96243.30y	243.06100	lldos	LLNL/ACTL	<1983	465
96244.30y	244.06300	lldos	LLNL/ACTL	<1983	483
96245.30y	245.06500	lldos	LLNL/ACTL	<1983	465
96246.30y	246.06700	lldos	LLNL/ACTL	<1983	491
96247.30y	247.07000	lldos	LLNL/ACTL	<1983	491
96248.30y	248.07200	lldos	LLNL/ACTL	<1983	495
Z = 97 ***** Berkelium *****					
97249.30y	249.07500	lldos	LLNL/ACTL	<1983	545
Z = 98 ***** Californium *****					
98249.30y	249.07500	lldos	LLNL/ACTL	<1983	491
98250.30y	250.07600	lldos	LLNL/ACTL	<1983	335
98251.30y	251.08000	lldos	LLNL/ACTL	<1983	485
98252.30y	252.08200	lldos	LLNL/ACTL	<1983	467

**VI. REFERENCES**

1. V. McLane, C. L. Dunford, and P.F. Rose, ed., "ENDF-102: Data Formats and Procedures for the Evaluated Nuclear Data File ENDF-6," BNL report, BNL-NCS-44945, revised (1995).
2. R. C. Little, "New Photon Library from ENDF Data," LANL internal memorandum to Buck Thompson (February 26, 1982).
3. H. G. Hughes, "Information on the Photon Library MCPLIB02," LANL internal memorandum X-6:HGH-93-77 (revised 1996).
4. R. C. Little, "Summary Documentation for the 100XS Neutron Cross Section Library (Release 1)," LANL internal memoradum XTM:RCL-95-259 and LA-UR-96-24 (1995).
5. R. C. Little, "Argon and Krypton Cross-section Files," LANL internal memorandum (June 30, 1982).
6. R. C. Little, "Cross Sections in ACE Format for Various IP Target Materials," LANL internal memorandum (August 19, 1982).

7. R. C. Little, "Y-89 cross sections for MCNP," LANL internal memorandum X-6:RCL-85-419, (1985).
8. R. C. Little, "Modified ENDF/B-V.0 Y-89 cross sections for MCNP," LANL internal memorandum X-6:RCL-85-443, (1985).
9. R. E. Seamon, "Revised ENDF/B-V Zirconium Cross Sections," LANL internal memorandum X-6:RES-92-324 (1992).
10. S. C. Frankle, "ENDL Fission Products, ENDL85 and ENDL92," LANL internal memorandum, XTM:95-254, (1995).
11. S. C. Frankle, "Summary Documentation for the ENDL92 Continuous-Energy Neutron Data Library (Release 1)," LANL Unclassified Release, XTM:96-05 and LA-UR-96-327, (1996).
12. R. Little and R. Seamon, "ENDF/B-V.0 Gd Cross Sections with Photon Production," LANL internal memorandum X-6:RCL-87-132, (1986).
13. S. C. Frankle, "ENDF62MT: A Multitemperature Neutron Library for MCNP (Rev. 0)," LANL internal memorandum XTM:SCF-96-153 (1996).
14. R. C. Little, "Neutron and Photon Multigroup Data Tables for MCNP3B," LANL internal memorandum X-6:RCL-87-225 (1987).
15. R. C. Little and R. E. Seamon, "New MENDF5 and MENDF5G," LANL internal memorandum X-6:RCL-86-412 (1986).
16. J. C. Wagner et al., "MCNP: Multigroup/Adjoint Capabilities," LANL report LA-12704 (1994).
17. R. E. Seamon, "Weight Functions for the Isotopes on Permfile THIRTY2," LANL Internal memorandum, TD-6 (July 23, 1976).
18. R. E. Seamon, "Plots of the TD Weight Function," LANL internal memorandum, X-6:RES-91-80 (1980).
19. R. E. MacFarlane and D. W. Muir, "The NJOY Nuclear Data Processing System," LANL report LA-12740 (1994).
20. R. C. Little and R. E. Seamon, "Dosimetry/Activation Cross Sections for MCNP," LANL internal memorandum, March 13, 1984.

**APPENDIX G  
REFERENCES**

## APPENDIX H

### FISSION SPECTRA CONSTANTS AND FLUX-TO-DOSE FACTORS

This Appendix is divided into two sections: fission spectra constants to be used with the SP input card and ANSI standard flux-to-dose conversion factors to be used with the DE and DF input cards.

#### I. *CONSTANTS FOR FISSION SPECTRA*

The following is a list of recommended parameters for use with the MCNP source fission spectra and the SP input card described in Chapter 3. The constants for neutron-induced fission are taken directly from the ENDF/B-V library. For each fissionable isotope, constants are given for either the Maxwell spectrum or the Watt spectrum, but not both. The Watt fission spectrum is preferred to the Maxwell fission spectrum. The constants for spontaneously fissioning isotopes are supplied by Madland of Group T-2. If you desire constants for isotopes other than those listed below, contact X-5. Note that both the Watt and Maxwell fission spectra are approximations. A more accurate representation has been developed by Madland in T-2. If you are interested in this spectrum, contact X-5.

##### A. *Constants for the Maxwell fission spectrum (neutron-induced)*

$$f(E) = CE^{1/2} \exp(-E/a)$$

	Incident Neutron Energy (MeV)	a(MeV)
n + <sup>233</sup> Pa	Thermal	1.3294
	1	1.3294
	14	1.3294
n + <sup>234</sup> U	Thermal	1.2955
	1	1.3086
	14	1.4792
n + <sup>236</sup> U	Thermal	1.2955
	1	1.3086
	14	1.4792
n + <sup>237</sup> U	Thermal	1.2996
	1	1.3162
	14	1.5063
n + <sup>237</sup> Np	Thermal	1.315
	1	1.315
	14	1.315

**APPENDIX H  
CONSTANTS FOR FISSION SPECTRA**

	<b>Incident Neutron Energy (MeV)</b>	<b>a(MeV)</b>
n + <sup>238</sup> Pu	Thermal	1.330
	1	1.330
	14	1.330
n + <sup>240</sup> Pu	Thermal	1.346
	1	1.3615
	14	1.547
n + <sup>241</sup> Pu	Thermal	1.3597
	1	1.3752
	14	1.5323
n + <sup>242</sup> Pu	Thermal	1.337
	1	1.354
	14	1.552
n + <sup>241</sup> Am	Thermal	1.330
	1	1.330
	14	1.330
n + <sup>242m</sup> Pu	Thermal	1.330
	1	1.330
	14	1.330
n + <sup>243</sup> Am	Thermal	1.330
	1	1.330
	14	1.330
n + <sup>242</sup> Cm	Thermal	1.330
	1	1.330
	14	1.330
n + <sup>244</sup> Cm	Thermal	1.330
	1	1.330
	14	1.330
n + <sup>245</sup> Cm	Thermal	1.4501
	1	1.4687
	14	1.6844
n + <sup>246</sup> Cm	Thermal	1.3624
	1	1.4075
	14	1.6412



**B. Constants for the Watt Fission Spectrum**

$$f(E) = C \exp(-E/a) \sinh(bE)^{1/2}$$

**1. Neutron-Induced Fission**

	<b>Incident Neutron Energy (MeV)</b>	<b>a(MeV)</b>	<b>b(MeV<sup>-1</sup>)</b>
n + <sup>232</sup> Th	Thermal	1.0888	1.6871
	1	1.1096	1.6316
	14	1.1700	1.4610
n + <sup>233</sup> U	Thermal	0.977	2.546
	1	0.977	2.546
	14	1.0036	2.6377
n + <sup>235</sup> U	Thermal	0.988	2.249
	1	0.988	2.249
	14	1.028	2.084
n + <sup>238</sup> U	Thermal	0.88111	3.4005
	1	0.89506	3.2953
	14	0.96534	2.8330
n + <sup>239</sup> Pu	Thermal	0.966	2.842
	1	0.966	2.842
	14	1.055	2.383

**2. Spontaneous Fission**

	<b>a(MeV)</b>	<b>b(MeV<sup>-1</sup>)</b>
<sup>240</sup> Pu	0.799	4.903
<sup>242</sup> Pu	0.833668	4.431658
<sup>242</sup> Cm	0.891	4.046
<sup>244</sup> Cm	0.906	3.848
<sup>252</sup> Cf	1.025	2.926

**II. FIUX-TO-DOSE CONVERSION FACTORS**

This section presents several flux-to-dose rate conversion factor sets for use on the DE and DF tally cards to convert from calculated particle flux to human biological dose equivalent rate. These sets of conversion factors are not the only ones in existence, nor are they recommended by this

## APPENDIX H

### FLUX-TO-DOSE CONVERSION FACTORS

publication. Rather, they are presented for convenience should you decide that one is appropriate for your use. The original publication cited or other sources should be consulted to determine if they are appropriate for your application.

Although the various conversion factor sets differ from one another, it seems to be the consensus of the health physics community that they do not differ significantly from most health physics applications where accuracies of 20% are generally acceptable. Some of the differences in the various sets are attributable to different assumptions about source directionality, phantom geometry, and depth of penetration. The neutron quality factors, derived primarily from animal experiments, are also somewhat different.

Be aware that conversion factor sets are subject to change based on the actions of various national and international organizations such as the National Council on Radiation Protection and Measurements (NCRP), the International Commission on Radiological Protection (ICRP), the International Commission on Radiation Units and Measurements (ICRU), the American National Standards Institute (ANSI), and the American Nuclear Society (ANS). Changes may be based on the re-evaluation of existing data and calculations or on the availability of new information. Currently, a revision of the 1977 ANSI/ANS<sup>1</sup> conversion factors is under way and the ICRP and NCRP are considering an increase in the neutron quality factors by a factor of 2 to 2.5.

In addition to biological dose factors, a reference is given for silicon displacement kerma factors for potential use in radiation effects assessment of electronic semiconductor devices. The use of these factors is subject to the same caveats stated above for biological dose rates.

#### A. *Biological Dose Equivalent Rate Factors*

In the following discussions, dose rate will be used interchangeably with biological dose equivalent rate. In all cases the conversion factors will contain the quality factors used to convert the absorbed dose in rads to rem. The neutron quality factors implicit in the conversion factors are also tabulated for information. For consistency, all conversion factors are given in units of rem/h per unit flux (particles/cm<sup>2</sup>-s) rather than in the units given by the original publication. The interpolation mode chosen should correspond to that recommended by the reference. For example, the ANSI/ANS publication recommends log-log interpolation; significant differences at interpolated energies can result if a different interpolation scheme is used.

##### 1. Neutrons

The NCRP-38 (Ref. 2) and ICRP-21 (Ref. 3) neutron flux-to-dose rate conversion factors and quality factors are listed in Table H.1. Note that the 1977 ANSI/ANS factors referred to earlier were taken from NCRP-38 and therefore are not listed separately.

##### 2. Photons



**APPENDIX H  
 FLUX-TO-DOSE CONVERSION FACTORS**

**TABLE H-2:  
 Photon Flux-to-Dose Rate Conversion Factors**  
**ANSI/ANS-6.1.1-1977**                      **ICRP-21**

<b>Energy, E (MeV)</b>	<b>DF(E) (rem/hr)/(p/cm<sup>2</sup>-s)</b>	<b>Energy, E (MeV)</b>	<b>DF(E) (rem/hr)/(p/cm<sup>2</sup>-s)</b>
0.01	3.96E-06	0.01	2.78E-06
0.03	5.82E-07	0.015	1.11E-06
0.05	2.90E-07	0.02	5.88E-07
0.07	2.58E-07	0.03	2.56E-07
0.1	2.83E-07	0.04	1.56E-07
0.15	3.79E-07	0.05	1.20E-07
0.2	5.01E-07	0.06	1.11E-07
0.25	6.31E-07	0.08	1.20E-07
0.3	7.59E-07	0.1	1.47E-07
0.35	8.78E-07	0.15	2.38E-07
0.4	9.85E-07	0.2	3.45E-07
0.45	1.08E-06	0.3	5.56E-07
0.5	1.17E-06	0.4	7.69E-07
0.55	1.27E-06	0.5	9.09E-07
0.6	1.36E-06	0.6	1.14E-06
0.65	1.44E-06	0.8	1.47E-06
0.7	1.52E-06	1.	1.79E-06
0.8	1.68E-06	1.5	2.44E-06
1.0	1.98E-06	2.	3.03E-06
1.4	2.51E-06	3.	4.00E-06
1.8	2.99E-06	4.	4.76E-06
2.2	3.42E-06	5.	5.56E-06
2.6	3.82E-06	6.	6.25E-06
2.8	4.01E-06	8.	7.69E-06
3.25	4.41E-06	10.	9.09E-06
3.75	4.83E-06		
4.25	5.23E-06		
4.75	5.60E-06		
5.0	5.80E-06		
5.25	6.01E-06		
5.75	6.37E-06		
6.25	6.74E-06		
6.75	7.11E-06		





APPENDIX I

PTRAC TABLES

TABLE I-1 presents the format of the PTRAC output file. TABLE I-2 –TABLE I-7 provide a detailed description of each variable in the output file. Note that capitalized variables with three or more characters refer to MCNP FORTRAN variables (except where noted) and are defined in Appendix E.

**TABLE I-1**  
**Format of the PTRAC Output File**

Format	Line	ASCII	Binary
		Format	Record
-1	1	(i5)	1
KOD, VER, LODDAT, IDTM	2	(a8,a5,a8,a19)	2
AID	3	(a80)	3
$m\ n_1\ V_2^1\ V_2^1\ \dots\ V_{n_1}^1\ \dots$	4	(1x,10e12.4)	4
. K total lines of PTRAC input data (see TABLE I-2)			
$N_1\ N_2\ \dots\ N_{20}$	4+K	(1x,20i5)	4+K
$L_1\ L_2\ \dots\ L_{N1}$	5+K	(1x,30i4)	5+K
$L_1^1\ L_2^1\ \dots\ L_{N2+N3}^1$			
. M total lines of variable IDs			
***** End of Header – Start NPS and Event Lines *****			
$I_1^1\ I_2^1\ \dots\ I_{N1}^1$	5+K+M	(1x,5i10,e13.5)	6+K
$J_1^1\ J_2^1\ \dots\ J_{N2,4,6,8,10}^1$	6+K+M	(1x,8i10)	7+K
$P_1^1\ P_2^1\ \dots\ P_{N3,5,7,9,11}^1$	7+K+M	(1x,9e13.5)	
$J_1^2\ J_2^2\ \dots\ J_{N2,4,6,8,10}^2$	8+K+M	(1x,8i10)	8+K
$P_1^2\ P_2^2\ \dots\ P_{N3,5,7,9,11}^2$	9+K+M	(1x,9e13.5)	
. Q total lines of event data for this history (see TABLE I-3)			
$I_1^2\ I_2^2\ \dots\ I_{N1}^2$	5+K+M+Q	(1x,5i10,e13.5)	6+K+Q/2

**TABLE I-1**  
**Format of the PTRAC Output File**

See TABLE I-3 for all possible values of  $N_2 - N_{11}$

$N_1$  = Number of variables on the NPS line ( $I_1 I_2 \dots$ ).

$N_2$  = Number of variables on 1<sup>st</sup> event line for an “src” event.

$N_3$  = Number of variables on 2<sup>nd</sup> event line for an “src” event.

$N_4$  = Number of variables on 1<sup>st</sup> event line for a “bnk” event.

$N_5$  = Number of variables on 2<sup>nd</sup> event line for a “bnk” event.

$N_6$  = Number of variables on 1<sup>st</sup> event line for a “sur” event.

$N_7$  = Number of variables on 2<sup>nd</sup> event line for a “sur” event.

$N_8$  = Number of variables on 1<sup>st</sup> event line for a “col” event.

$N_9$  = Number of variables on 2<sup>nd</sup> event line for a “col” event.

$N_{10}$  = Number of variables on 1<sup>st</sup> event line for a “ter” event.

$N_{11}$  = Number of variables on 2<sup>nd</sup> event line for a “ter” event.

$N_{12}$  = IPT for single particle transport, otherwise 0.

$N_{13}$  = 4 for real\*4 output and 8 for real\*8 output

$N_{14} - N_{20}$  = not used.

See TABLE I-4 for definitions of variable IDs:

$L_1 L_2 \dots L_{N_1}$  = List of variable IDs for the NPS line.

$L_1^1 L_2^1 \dots L_{N_2+N_3}^1$  = List of variable IDs for an “src” event.

$L_1^2 L_2^2 \dots L_{N_4+N_5}^2$  = List of variable IDs for a “bnk” event.

$L_1^3 L_2^3 \dots L_{N_6+N_7}^3$  = List of variable IDs for a “sur” event.

$L_1^4 L_2^4 \dots L_{N_8+N_9}^4$  = List of variable IDs for a “col” event.

$L_1^5 L_2^5 \dots L_{N_{10}+N_{11}}^5$  = List of variable IDs for a “ter” event.

See TABLE I-4 for corresponding variable IDs:

$I_1$  = NPS.

$I_2$  = Event type of the 1<sup>st</sup> event for this history (see TABLE I-5).

$I_3$  = Cell number if cell filtered, otherwise omitted.

$I_4$  = Surface number if surface filtered, otherwise omitted.

$I_5$  = Tally number if tally filtered, otherwise omitted.

$I_6$  = TFC bin tally if tally filtered, otherwise omitted.



**TABLE I-2**  
**PTRAC Input Format**

$$m \ n_1 V_1^1 V_2^1 \dots V_{n_1}^1 \quad n_2 V_1^2 V_2^2 \dots V_{n_2}^2 \dots \quad n_{13} V_1^{13} V_2^{13} \dots V_{n_{13}}^{13}$$

m = Number of PTRAC keywords = 13

$n_i$  = Number of entries for  $i^{\text{th}}$  keyword or 0 for no entries.

$V_1 V_2 \dots V_{n_i} = 1^{\text{st}}$  entry,  $2^{\text{nd}}$  entry, ... for the  $i^{\text{th}}$  keyword (see below).

Index	Keyword	Index	Keyword	Index	Keyword	Index	Keyword
1	BUFFER	5	FILTER	9	SURFACE	13	WRITE
2	CELL	6	MAX	10	TALLY		
3	EVENT	7	MENP	11	TYPE		
4	FILE	8	NPS	12	VALUE		

**TABLE I-3**  
**Event Line Variable IDs (See TABLE I-4)\***

Index	Type 1 ( $N_{12} \neq 0$ WRITE = pos)		Type 2 ( $N_{12} = 0$ WRITE=pos)		Type 3 ( $N_{12} \neq 0$ WRITE = all)		Type 4 ( $N_{12} = 0$ WRITE=all)	
	$N_2=5$	$N_{4,6,8,10}=6$	$N_2=6$	$N_{4,6,8,10}=7$	$N_2=6$	$N_{4,6,8,10}=7$	$N_2=7$	$N_{4,6,8,10}=8$
	$N_3=3$	$N_{5,7,9,11}=3$	$N_3=3$	$N_{5,7,9,11}=3$	$N_3=9$	$N_{5,7,9,11}=9$	$N_3=9$	$N_{5,7,9,11}=9$
J <sub>1</sub>	7	7	7	7	7	7	7	7
J <sub>2</sub>	8	8	8	8	8	8	8	8
J <sub>3</sub>	9	10,12,10,14	9	10,12,10,14	9	10,12,10,14	9	10,12,10,14
J <sub>4</sub>	17	11,13,11,15	16	11,13,11,15	17	11,13,11,15	16	11,13,11,15
J <sub>5</sub>	18	17	17	16	18	17	17	16
J <sub>6</sub>		18	18	17	19	18	18	17
J <sub>7</sub>				18		19	19	18
J <sub>8</sub>								19
P <sub>1</sub>	20	20	20	20	20	20	20	20
P <sub>2</sub>	21	21	21	21	21	21	21	21
P <sub>3</sub>	22	22	22	22	22	22	22	22
P <sub>4</sub>					23	23	23	23
P <sub>5</sub>					24	24	24	24
P <sub>6</sub>					25	25	25	25
P <sub>7</sub>					26	26	26	26
P <sub>8</sub>					27	27	27	27
P <sub>9</sub>					28	28	28	28

\* For a “bnk” event ( $N_4, N_5$ ), interpret  $J_1 \dots J_4 = 7,8,10,11$   
 For a “sur” event ( $N_6, N_7$ ), interpret  $J_1 \dots J_4 = 7,8,12,13$   
 For a “col” event ( $N_8, N_9$ ), interpret  $J_1 \dots J_4 = 7,8,10,11$   
 For a “ter” event ( $N_{10}, N_{11}$ ), interpret  $J_1 \dots J_4 = 7,8,14,15$

**TABLE I-4**  
**Description of Variable IDs**

Variable ID	MCNP Name	Description
NPS LINE		
1	NPS	See Appendix E
2	—	Event type of 1 <sup>st</sup> event (see TABLE I-5 )
3	NCL(ICL)	See Appendix E
4	NSF(JSU)	See Appendix E
5	JPTAL(1,ITAL)	See Appendix E
6	TAL(JPTAL(7,ITAL))	See Appendix E
EVENT LINE		
7	—	Event type of next event (see TABLE I-5 )
8	NODE	See Appendix E
9	NSR	See Appendix E
10	NXS(2,IEX)	See Appendix E
11	NTYN	Reaction type (see TABLE I-7 )
12	NSF(JSU)	Reaction type (see TABLE I-7 )
13	—	Angle with surface normal (degrees)
14	NTER	Termination type (see TABLE I-7 )
15	—	Branch number for this history
16	IPT	See Appendix E
17	NCL(ICL)	See Appendix E
18	MAT(ICL)	See Appendix E
19	NCP	See Appendix E
20	XXX	See Appendix E
21	YYY	See Appendix E
22	ZZZ	See Appendix E
23	UUU	See Appendix E
24	VVV	See Appendix E
25	WWW	See Appendix E
26	ERG	See Appendix E
27	WGT	See Appendix E
28	TME	See Appendix E

**TABLE I-5**  
**Event Type Description**

Location	Variable ID	Event Type					Flag*
		src	bnk**	sur	col	ter	
J <sub>1</sub>		1000	±(2000+l)	3000	4000	5000	9000

\*When J<sub>1</sub> = 9000, this event is the last event for this history.

\*\*When J<sub>1</sub> < 0, the next event has been rejected and is included for creation information only. The value L is given in TABLE I-6 .

**TABLE I-6**  
**Bank Event Descriptions**

L Value	Description	MCNP Subroutine	NXS & NTYN Provided
1	DXTRAN Track	DXTRAN	Y
2	Energy Split	ERGIMP	N
3	Weight Window Surface Split	WTWNDO	N
4	Weight Window Collision Split	WTWNDO	Y
5	Forced Collision-Uncollided Part	FORCOL	N
6	Importance Split	SURFAC	N
7	Neutron from Neutron (n,xn) (n,f)	COLIDN	Y
8	Photon from Neutron	ACEGAM	Y
9	Photon from Double Fluorescence	COLIDP	Y
10	Photon from Annihilation	COLIDP	N
		ELECTR	
11	Electron from Photoelectric	EMAKER	Y
12	Electron from Compton	EMAKER	Y
13	Electron from Pair Production	EMAKER	Y
14	Auger Electron from Photon/X-ray	EMAKER	Y
15	Positron from Pair Production	EMAKER	N
16	Bremsstrahlung from Electron	TTBR	N
		BREMS	
17	Knock-on Electron	KNOCK	N
18	X-rays from Electron	KXRAY	N
19	Photon from Neutron - Multigroup	MGCOLN	Y
20	Neutron (n,f) - Multigroup	MGCOLN	Y
21	Neutron (n,xn) k- Multigroup	MGCOLN	Y
22	Photo from Photon - Multigroup	MGCOLN	Y
23	Adjoint Weight Split - Multigroup	MGACOL	N

**TABLE I-7**  
**NTER and NTYN Variable Descriptions**

NTER	Description	NTYN	Description
1	Escape	<b>NEUTRON</b>	
2	Energy cutoff	1	Inelastic S( $\alpha,\beta$ )
3	Time cutoff	2	Elastic S( $\alpha,\beta$ )
4	Weight window	-99	Elastic scatter
5	Cell importance	>5	Inelastic scatter (see UKAEA Nuclear Data File)
6	Weight cutoff		
7	Energy importance		
8	DXTRAN		
9	Forced collision	<b>PHOTON</b>	
10	Exponential transform	1	Incoherent scatter
<b>NEUTRON</b>		2	Coherent scatter
11	Downscattering	3	Fluorescence
12	Capture	4	Double fluorescence
13	Loss to (n,xs)	5	Pair production
14	Loss to fission		
<b>PHOTON</b>			
11	Compton scatter		
12	Capture		
13	Pair production		
<b>ELECTRON</b>			
11	Scattering		
12	Bremsstrahlung		

## Appendix J

### Mesh-Based WWINP, WWOUT, and WWONE File Format

The mesh-based weight window input file WWINP and the mesh-based weight window output files WWOUT and WWONE are ASCII files with a common format. The files consist of three blocks. Block 1 contains the header information, energy (or time) group numbers, and basic mesh information. Block 2 contains the mesh geometry. Block 3 contains the energy (or time) group boundaries and lower weight window bounds. Table J.1 presents the file format using generic variables. Table J.2 describes the variables and gives the equivalent variables from the WWINP, WWOUT, and WWONE files.

The 3 x 3 array of fine mesh cells is stored by assigning an index number to each cell. The assignment of mesh cells is illustrated in Fig. J-1. For each value of  $z$  (or  $\theta$ ), all cells are indexed in the  $x$ - $y$  plane (or the  $r$ - $z$  plane). The cell index number is related to the fine mesh number in each coordinate direction through the following formula:

$$\text{cell index number} = 1 + (i - 1) + nfx(j - 1) + nfx \cdot nfy(k - 1),$$

where  $i$ ,  $j$ , and  $k$  are the fine mesh cell numbers along the  $x(r)$ ,  $y(z)$ , and  $z(\theta)$  directions, respectively, and  $nfx$ ,  $nfy$ , and  $nfz$  (by implication) are the total number of fine meshes in the  $x(r)$ ,  $y(z)$ , and  $z(\theta)$  directions, respectively

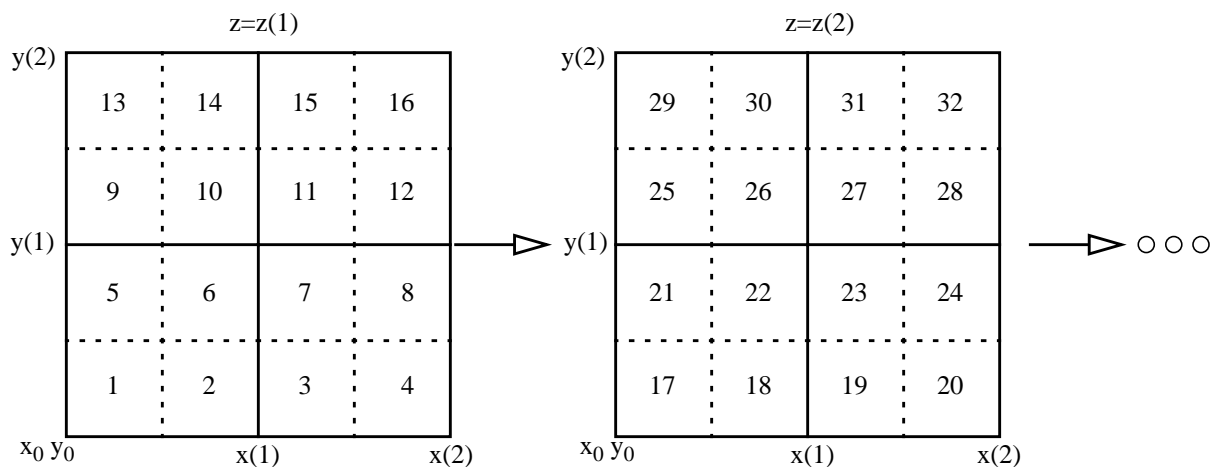

Figure J-1. Superimposed mesh cell indexing

**TABLE J.1:**  
**Format of the Mesh-Based WWINP, WWOUT and WWONE File**

FORMAT	VARIABLE LIST
	<b>BLOCK 1</b>
4i10	if iv ni nr
7i10	ne(1) ... ne(ni)
	<i>nr = 10:</i>
6g13.5	nfx nfy nfz x <sub>0</sub> y <sub>0</sub> z <sub>0</sub>
6g13.5	ncx ncy ncz nwg
	<i>nr = 16:</i>
6g13.5	nfx nfy nfz x <sub>0</sub> y <sub>0</sub> z <sub>0</sub>
6g13.5	ncx ncy ncz xmax ymax zmax
6g13.5	xr yr zr nwg
	<b>BLOCK 2</b>
	<i>nwg = 1:</i>
6g13.5	x <sub>0</sub> nfm <sub>x</sub> (1) x(1) rx(1) nfm <sub>x</sub> (2) x(2)
6g13.5	rx(2) ... nfm <sub>x</sub> (ncx) x(ncx) rx(ncx)
6g13.5	y <sub>0</sub> nfm <sub>y</sub> (1) y(1) ry(1) nfm <sub>y</sub> (2) y(2)
6g13.5	ry(2) ... nfm <sub>y</sub> (ncy) y(ncy) ry(ncy)
6g13.5	z <sub>0</sub> nfm <sub>z</sub> (1) z(1) rz(1) nfm <sub>z</sub> (2) z(2)
6g13.5	rz(2) ... nfm <sub>z</sub> (ncz) z(ncz) rz(ncz)
	<i>nwg = 2</i>
6g13.5	r <sub>0</sub> nfm <sub>r</sub> (1) r(1) rr(1) nfm <sub>r</sub> (2) r(2)
6g13.5	rr(2) ... nfm <sub>r</sub> (ncx) r(ncx) rr(ncx)
6g13.5	z <sub>0</sub> nfm <sub>z</sub> (1) z(1) rz(1) nfm <sub>z</sub> (2) z(2)
6g13.5	rz(2) ... nfm <sub>z</sub> (ncy) z(ncy) rz(ncy)
6g13.5	θ <sub>0</sub> nfm <sub>θ</sub> (1) θ(1) rθ(1) nfm <sub>θ</sub> (2) θ(2)
6g13.5	rθ(2) ... nfm <sub>θ</sub> (ncz) θ(ncz) rθ(ncz)
	<b>BLOCK 3</b>
	<i>Particle i, i=1,ni</i>
6g13.5	e(i,1) ... e(i,ne(i))
	<i>Energy (or time) group j, j=1,ne(i)</i>
6g13.5	w(i,j,1) ... w(i,j,nwm)

**TABLE J.2:**  
**Explanations of Variables from Table J.1**

VARIABLE	WWINP	WWOUT	WWONE
if	File type. Only 1 is supported.		
iv	Unused		
ni	Number of integers on card 2		
nr	Number of parameters from nfx through nwg at the end of Block 1. nr = 10 / 16 for rectangular/ cylindrical mesh		
ne(i)	NWW(i)	NGWW(i)	1 for each i for which NGWW(i) $\neq$ 0
nf[x,y,z]	WWM(1-3)		WWMA(1-3)
x <sub>0</sub> , y <sub>0</sub> , z <sub>0</sub>	WWM(4-6)		WWMA(4-6)
nc[x,y,z]	WWM(7-9)		WWMA(7-9)
[x,y,z]max	WWM(10-12)		WWMA(10-12)
xr, yr, zr	WWM(13-15)		WWMA(13-15)
nwg	NWGEOM		NWGEOA
nfm[x,y,z / r,z,θ](i)	WGM(*)		WGMA(*)
	Number of fine mesh cells in coarse mesh cell i in x,y,z / r,z,θ directions		
[x,y,z / r,z,θ](i)	WGM(*)		WGMA(*)
	Upper coordinate of coarse mesh cell i in x,y,z/ r,z,θ directions		
r[x,y,z / r,z,θ](i)	WGM(*)		WGMA(*)
	Fine mesh ratio in coarse mesh cell i in x,y,z /r,z,θ directions. Currently only 1. is supported.		
r <sub>0</sub> , z <sub>0</sub> , θ <sub>0</sub>	Origin of the radial, axial, and azimuthal directions; must be 0., 0., 0.		
e(i,j)	WWE(*)	EWVG(*)	Default maximum jth upper energy (or time) bound for particle type i
w(i,j,k)	WWF(*)		Weight window generator output Lower weight window bound for particle i, energy (or time) group j, and fine mesh cell k
nwm	NWWM		NWWMA

## Appendix J



**S  
E  
C  
T  
I  
O  
N  
  
5**

*MCNP<sup>TM</sup> Software Quality Assurance Plan*

*Hilary M. Abhold  
John S. Hendricks*

# TABLE OF CONTENTS

ABSTRACT.....	1
I. PURPOSE.....	2
A. Plan Reviews.....	2
II. MANAGEMENT.....	2
A. Organization.....	2
B. Tasks .....	3
1. Concept Exploration .....	3
2. Requirements & Design .....	3
3. Implementation.....	5
4. Test.....	5
5. Installation and Checkout .....	5
6. Operation and Maintenance .....	5
7. Retirement.....	5
C. Responsibilities .....	13
III. DOCUMENTATION .....	14
IV. STANDARDS, PRACTICES, CONVENTIONS, AND METRICS .....	17
A. Documentation Standards .....	17
B. Logic Structure Standards.....	17
C. Coding Standards .....	17
D. Commentary Standards .....	17
E. Testing Standards and Practices .....	17
F. Selected Software Quality Assurance Product and Process Metrics .....	18
V. REVIEWS AND AUDITS .....	18
A. Purpose.....	18
B. Feature Reviews.....	18
C. Intermediate Version Patch and Patch Documentation Review.....	18
D. Coding Reviews and Audits.....	19
E. Documentation Reviews .....	19
F. Cross Reference .....	19
VI. TEST .....	21
VII. PROBLEM REPORTING AND CORRECTIVE ACTION.....	22
VIII. TOOLS, TECHNIQUES, AND METHODOLOGIES.....	22
IX. CODE CONTROL.....	22
X. MEDIA CONTROL.....	22
XI. SUPPLIER CONTROL .....	23
XII. RECORDS COLLECTION, MAINTENANCE, AND RETENTION.....	23

XIII. TRAINING .....	23
XIV. RISK MANAGEMENT.....	23
REFERENCES .....	24
APPENDIX A.....	25
I.    PURPOSE.....	25
II.   VERIFICATION.....	25
A. Approval of Requirements.....	25
B. Approval of Design.....	25
C. Approval of Implementation.....	26
III.  VALIDATION.....	26
APPENDIX B .....	27
I.    PURPOSE.....	27
II.   SCOPE.....	27
III.  CONFIGURATION IDENTIFICATION.....	27
IV.   CONFIGURATION CHANGE CONTROL.....	29
V.    CONFIGURATION STATUS ACCOUNTING .....	30
VI.   RESPONSIBILITIES .....	30
APPENDIX C .....	31
I.    SOFTWARE REQUIREMENTS SPECIFICATION .....	31
II.   SOFTWARE DESIGN DESCRIPTION.....	31
III.  SOFTWARE VERIFICATION AND VALIDATION PLAN (SVVP).....	31
IV.   SOFTWARE VERIFICATION AND VALIDATION REPORT (SVVR).....	31
V.    USER DOCUMENTATION .....	31
VI.   SOFTWARE CONFIGURATION MANAGEMENT PLAN (SCMP) .....	31
APPENDIX D.....	33
I.    PURPOSE.....	33
II.   SOFTWARE REQUIREMENTS REVIEW.....	33
III.  PRELIMINARY DESIGN REVIEW .....	33
IV.   CRITICAL DESIGN REVIEW .....	33
V.    SOFTWARE VERIFICATION AND VALIDATION PLAN REVIEW .....	33
VI.   D6 FUNCTIONAL AUDIT.....	34
VII.  D7 PHYSICAL AUDIT.....	34
VIII. IN-PROCESS AUDITS.....	34

IX. MANAGERIAL REVIEWS .....	34
X. SOFTWARE CONFIGURATION MANAGEMENT PLAN REVIEW .....	34
XI. POST MORTEM REVIEW .....	34
APPENDIX E .....	35
APPENDIX F.....	37

## LIST OF FIGURES

Fig. 1.	Sample Features List .....	4
Fig. 2.	Sample BoD Meeting Minutes .....	6
Fig. 3.	Sample Patch .....	7
Fig. 4.	Sample Intermediate Version Release Memo .....	10
Fig. 5.	Sample Bug List .....	11
Fig. 6.	Sample Letter Releasing a Major Version to RSIC .....	12
Fig. 7.	Sample Memo Describing Patch Documentation .....	16
Fig. 8.	Sample MCNP Manual Release Memo .....	20

# LIST OF TABLES

TABLE I: DOCUMENT AND STANDARD CROSS REFERENCE.....	35
TABLE II: MCNP TASKS .....	39

# MCNP<sup>TM</sup> SOFTWARE QUALITY ASSURANCE PLAN

by

Hilary M. Abhold and John S. Hendricks

## ABSTRACT

MCNP is a computer code that models the interaction of radiation with matter. MCNP is developed and maintained by the Transport Methods Group (XTM) of the Los Alamos National Laboratory (LANL). This plan describes the Software Quality Assurance (SQA) program applied to the code. The SQA program is consistent with the requirements of IEEE-730.1 and the guiding principles of ISO 9000.



## **I. PURPOSE**

This document is the Software Quality Assurance Plan (SQAP) for modification and maintenance of the Monte Carlo N-Particle (MCNP) radiation transport code. MCNP is developed and maintained by the Transport Methods Group (XTM) of the Los Alamos National Laboratory (LANL). The code models the interaction of radiation with matter.

The particular software covered is the MCNP Fortran and C source code released to the Radiation Shielding Information Center (RSIC) in Oak Ridge, Tennessee. Specifically excluded are non-XTM modified versions or auxiliary codes distributed with MCNP by XTM. Also specifically excluded is the quality assurance of data libraries used by the code.

MCNP is a mature product that is continually being upgraded. This SQAP applies to MCNP upgrades from one major version to another. A major version of MCNP is a version which is released every few years to RSIC for international distribution.

This quality assurance plan covers the entire MCNP software modification life cycle: concept exploration, requirements and design, implementation, test, installation and check-out, operation and maintenance, and retirement. It is consistent with IEEE 730.1<sup>1</sup> and with the guiding principles of ISO 9000.<sup>2</sup>

### **A. Plan Reviews**

The MCNP SQAP is reviewed and approved by the MCNP Board of Directors (BoD) and the Group Office concurrently. The plan and implemented procedures are subject to group office audit at any time.

## **II. MANAGEMENT**

### **A. Organization**

Software quality assurance for MCNP is the responsibility of the Transport Methods Group (XTM) of Los Alamos National Laboratory. XTM is divided into teams, each with a Team Leader who reports to the Group Office. The Monte Carlo team does code development for MCNP. The Group Office is comprised of the Group Leader and Deputy Group Leader. A Board of Directors (BoD) is composed of team members of the Transport Methods Group from the

applications team, data team, and other teams as appropriate. Members of the BoD are assigned by the Group Office.

The Monte Carlo Team is responsible for the maintenance and development of MCNP. The BoD reviews all proposed features of MCNP, reviews their implementation, and has final authority for acceptance of new features. Consensus between the BoD, Group Office, and Monte Carlo Team is required for all changes beyond regular maintenance.

Changes to this Software Quality Assurance Plan are made with the concurrence of the Monte Carlo Team Leader, the MCNP BoD, and the Group Office.

## **B. Tasks**

The MCNP software quality assurance plan applies to all stages of the MCNP software life cycle: concept exploration, requirements and design, implementation, test, installation and checkout, operation and maintenance, and retirement. The following paragraphs describe the iterative tasks involved in the MCNP software lifecycle and identify which tasks help assure software quality.

- 1. Concept Exploration.** A features list is compiled of desired features for future major versions of MCNP. This features list is kept by the Monte Carlo Team. It is documented archivally on the Common File System (CFS). This list includes all features proposed or accepted for the previous major version that did not become part of the previous major version. It also includes proposed new features. At the features review, the MCNP BoD approves or disapproves features for inclusion into MCNP. The features list indicates whether the feature was accepted or rejected. See Fig. 1 for a sample features list.

- 2. Requirements & Design.** Many proposed modifications to MCNP come with the software already developed in the form of patches. These patches range in quality. Some patches are accompanied by good documentation and no further software requirements specifications or software design are necessary.

Date

Desired MCNP 4B Features

(Number Key: H=High Priority, M=Medium, L=Low)  
(State Key: N=New, A[U,D]=Accepted [Underway,Done] R=Rejected)

Number	Description	State
<b>Physics</b>		
P-H1	Incorporate data and/or geometric perturbation sensitivity capability. (Schrandt 1/25/82). (Schlumberger request, 10/11/93).	AU (GWM) 10/18/93
P-H2	Incorporate INRAD capabilities (X-6:GPE-91-169) LA-11153-MS (X-6:JSH-92-73) (X-6:JSH-92-257)	AU (JSH)
<b>Variance</b>		
V-H1	Tom Booth's Quasi-deterministic weight window generator	A (JSH)
<b>Internal</b>		
I-H1	Smart PVM workstation cluster capability, particularly load balancing. (Schlumberger, 10/11/93)	A 03/29/94

Fig. 1. Sample Features List

The MCNP BoD decides by consensus which features and/or patches to accept into the next major version of MCNP. The acceptance or rejection of a feature is documented in the features list and the BoD meeting minutes. (See Fig. 2 for an example of the meeting minutes.) Accepted features are prioritized by the BoD and recommendations are made on the software requirements and design (particularly the user interface). For new features not accompanied by a patch, or for substandard patches, new software requirements specifications and software design descriptions are Implementation created by the Monte Carlo Team. These created patches along with their documentation are reviewed and approved as intermediate version patches by the BoD.

**3. Implementation.** Patches that have been approved for implementation into MCNP are integrated with other patches to form an intermediate version. (See Fig. 3 for an example of a patch.) All lines of code and documentation are independently reviewed by the MCNP code developer who integrates the patch. The developer who integrates the patch may not be the code developer who developed the patch.

**4. Test.** The Monte Carlo Team tests all new features in accordance with the MCNP Software Verification and Validation Plan in Appendix A.

**5. Installation and Checkout.** The installation and checkout procedure is described in Appendix C of the MCNP manual.

**6. Operation and Maintenance.** All new features are independently documented in LANL memos at the intermediate version release by the Monte Carlo Team. (See Fig. 4 for an example of an intermediate version patch release memo.) A bug list is compiled of all claimed bugs or deficiencies. (See Fig. 5 for an example bug list.) Bugs are investigated and corrections are identified. All bug fixes are commented on with references as appropriate in the major patch file converting the last major version of MCNP to the next. A list of bugs is periodically published and circulated (for example, Ref. 4), as well as by the use of an e-mail network for notifying users of new features and bugs found.

**7. Retirement.** When a new major version of MCNP is released by RSIC, support for the previous version is terminated/discontinued and support for the version before that is terminated. Support for all intermediate versions is dropped and intermediate versions are destroyed. See Fig. 6 for a sample of a letter releasing a major version to RSIC.

**Los Alamos**  
NATIONAL LABORATORY  
**memorandum**

*Applied Theoretical & Computational Physics Division  
XTM, Transport Methods Group*

To/MS: Distribution  
From/MS: Monte Carlo team Leader, XTM  
Phone/FAX: 5-6789/5-5538  
Symbol: XTM-yy-xxx  
Date: Month, Day, Year

**MCNP<sup>TM</sup> BoD Meeting Minutes, Date**

**Date MCNP Board of Directors Minutes**

Charter: The MCNP Board of Directors (BoD) is a body of XTM staff with authority over the direction, developments, and software quality assurance (SQA) of MCNP. The BoD reviews and recommends new code features and code modifications, particularly user interface and other issues affecting customers and users, and also considers issues such as data and policy.

Attending the Date meeting: put attending members here.

**Resolved Issues**

Put appropriate issues here, such as accepted or rejected features, et cetera.

**Action Items**

Put appropriate action items here.

**Agenda for the next meeting**

Put appropriate information here.

---

MCNP is a trademark of the Regents of the University of California, Los Alamos National Laboratory.

**Fig. 2. Sample BoD Meeting Minutes**

```

c          <<<<< MCNP4XQ makemcnp changes for MCNP4A >>>>> loddatt 03/01/96
c***** FIXES FOR SYSTEM 1 (Cray UNICOS) *****
c
c      Keep NEWID file for UNICOS
c      1 2 23 2 1
c      rm -f codef patch

c***** FIXES FOR SYSTEM 7 (PC  DOS  ) *****
c
c      Provide changes for X-windows on a PC. Software requirements:
c      MetaWare High C 3.3, DESQview/X 2.0 with MetaWare X11 toolkit.
c      These changes allow for continued support of Lahey graphics.
c      7 2 25 1 9
c      if exist mcnpc.c del mcnpc.c
c      copy mcnpc.id codef
c      copy patchc patch
c      prpr
c      rename compile mcnpc.c
c      del codef
c      del patch
c      del newid
c      hc386 -f387 -DMSDOS -Hoff=protection -I\dvx\include -c mcnpc.c
c      7 2 33 1 4
c      type patchf | find "*define pcdos" | find "xlib"
c      if errorlevel 1 goto lahey
c      goto xwin
c      :lahey
c      7 2 34 1 5
c      goto end
c      :xwin
c      set lib=\f7713\lib;\hc33\small;\dvx\lib\hc387
c      386link -nomap -pack mcnp \f7713\lib\hc320 mcnpc -l
c      hc386,hc387,hcna,x11,sys
c      :end

0 3 2 4 4
0 3 5 2
*/          <<<<< MCNP4XQ C patch to MCNP4A >>>>>          loddatt 03/01/96
*/
*/ ----- mcnpc.id

```

**Fig. 3. Sample Patch**

```

*ident mc4xq
*/ Remove the DIFFTIME() routine.                                07/03/95 (GWM/GWM)
*d,mc.12,mc.13                                                    <25-26>
*if -def,unix,1
#include <unistd.h>
*/ Make changes for PC MetaWare High C compiler.                02/15/95 (GWM/GWM)
*i,mc.18                                                            <31>
*if def,pcdos,5
/* Define a structure for use with Lahey FORTRAN and MetaWare C. */
typedef struct
{ char *text;
  long leng;
} Lahey_Char;
*i,mc.50                                                            <63>
XSetWindowAttributes attributes;
*d,mc.73                   Replace screen variable for PC X-windows    <86>
    pnt_x, pnt_y, res_x, res_y, scrnrm, width, win_flag, win_shape,
*/
*/ ----- xgopwk
/* Define a structure for use with Lahey FORTRAN and MetaWare C. */
*d,mc.137                                                            <150>
for(i=0; *font_bas[i] != '\0'; i++)
*d,mc.145,mc.149 Replace screen variable for PC X-windows    <158-162>
scrnrm=DefaultScreen(display);
display_width=DisplayWidth(display,scrnrm);
display_width_mm=DisplayWidthMM(display,scrnrm);
display_height=DisplayHeight(display,scrnrm);
display_height_mm=DisplayHeightMM(display,scrnrm);

c          <<<<< MCNP4XQ Fortran patch to MCNP4A >>>>>          loddat 03/01/96

c    Delete lines 2-10 of PATCHF.
  0 1 2 4 10
c    Add this entire patch to PATCHF.
  0 1 11 2
*/
*/ ----- comdeck zc

```

Fig. 3. Sample Patch (cont.)

```

*ident zc4xq
*d,zc4a.1                                     <21>
    parameter (kod='mcpn',ver='4xq')
*/ Set mdas in install.fix file to facilitate installation.      03/30/95
*d,zc4a.5                                     <30>
    parameter (mdas=4000000)
*/
*/ ----- block data
*ident bd4xq
*/ Variably dimension ebl, febl, to prevent multigroup crash.
*/ (X-6:ELR-94-362, X-6:JSH-94-468).                          7/25/94 (ELR/JSH)
*d,bd.8 data ebl                                             <490>
*d,bd4a.13                                                  <575>
    3 hsd/'sequential','direct',//,ibin/'fdusmcpet',//,loddatt/'03/01/96'//,
*d,cor4-2.24
    3 hdpatt/'usr/local/udata/mcpn'//,
*/
*/ ----- tpefil
*ident tf4xq
*/ Do not flush output, tty buffers: compiler problems.      (JSH) 8/3/94
*d,tf4a.21 go to 162                                         <1299>
    return
*/ Do not flush output, tty buffers: compiler problems.      (JSH) 8/3/94
*d,tf4a.37,tf4a.47 before return                            <1362-1372>
*d,tf.112 call balk                                         <1383>

```

**Fig. 3. Sample Patch (cont.)**



**Los Alamos**  
NATIONAL LABORATORY  
**memorandum**

*Applied Theoretical & Computational Physics Division  
XTM, Transport Methods Group*

To/MS: Distribution  
From/MS: Monte Carlo Team Leader, XTM  
Phone/FAX: 5-6789/5-5538  
Symbol: XTM-yy-xxx  
Date: Month, Day, Year

**MCNP4XN**

Another intermediate version of MCNP<sup>TM</sup> is now available: MCNP4XN.

**New Features and Corrections in MCNP4XN**

The major differences from this MCNP version and the last one, MCNP4XL are:

*include major differences here*

Minor improvements include:

*include minor improvements here.*

**Availability**

Executables for all systems are available on: put info here

**Code Review**

All MCNP4XN code has been multiply reviewed by members of the Monte Carlo Team. The Patch and Patch Documentation has been reviewed and this memo certifies that:

- 1) the MCNP4XN patch meets the software requirements specifications documented in memo XTM-yy-xxxx;
  - 2) the patch is properly designed and implemented;
- and
- 3) the patch is properly documented in this memo.

**Testing**

Put Testing info here.

---

MCNP is a trademark of the Regents of the University of California, Los Alamos National Laboratory.

**Fig. 4. Sample Intermediate Version Release Memo**

Possible MCNP 4A Bugs			Date
(H=High Priority, M=Medium, L=Low)			
Number	Description		State
H1	Question whether PWT card is used i WVN!:P is used (PWT values in output may be inconsistent.)		N
H2	DXTRAN with flagged-cell tallies - only flagged if parent particle departs the cell		N
H3	.....		
H4	.....		
H5	.....		
H6	Add PCDOS and LAHEY keyword print in print table 98.		D (JSH) 12/19/93
M1	Make F8:N,P,E a warning, not fatal. GWM argues 1/19/94 that F8 and mode N should be fatal.		N

**Fig. 5. Sample Bug List**

# Los Alamos

NATIONAL LABORATORY

*Applied Theoretical & Computational Physics Division  
XTM, Transport Methods Group  
Los Alamos, New Mexico 87545  
(505) 667-4189  
FAX (505) 665-5538*

DATE: Month, Day, Year  
IN REPLY REFER TO: XTM-yy-xxx  
MAIL STOP: B226  
TELEPHONE: (505) 665-6789

Radiation Shielding Information Center  
Building 6025, MS6362  
Oak Ridge National Laboratory  
P.O. Box 2008  
Oak Ridge, TN 37831-6362

To Whom It May Concern:

*put info about release here.*

Software Verification and Validation Report

This letter certifies that MCNP<sup>TM</sup> version XX meets the requirements of the MCNP Software Verification and Validation Plan.

Very Truly Yours,

John. Q. Team Leader  
Monte Carlo Team Leader  
Los Alamos National Laboratory

---

MCNP is a trademark of the Regents of the University of California, Los Alamos National Laboratory

**Fig. 6. Sample Letter Releasing a Major Version to RSIC**

### C. Responsibilities

The Monte Carlo Team is responsible for maintenance and development of MCNP in general, and specifically for:

- a) maintaining the features list,
- b) developing software requirements specifications and software design for new features and/or substandard patches,
- c) integrating patches into MCNP,
- d) reviewing the implementation of patches into MCNP;
- e) testing new features,
- f) documenting new features,
- g) maintaining the bug list,
- h) investigating bug claims and providing corrections to bugs along with documentation of those bugs,
- i) approving, concurrent with the BoD and the Group Office, all changes to MCNP beyond regular maintenance,
- j) following SQA procedures defined in this plan.

The Board of Directors has final authority for acceptance of new features into MCNP, and is specifically responsible for:

- a) approving additions and deletions of features to MCNP,
- b) prioritizing approved items on the features list,
- c) making recommendations to the Monte Carlo team on requirements and design for new features and/or substandard patches,
- d) approving patches for incorporation into MCNP along with accompanying documentation,
- e) approving, concurrent with the Monte Carlo Team and the Group Office, all changes to MCNP beyond regular maintenance,
- f) following SQA procedures defined in this plan.

The Group Office is responsible for software quality assurance for MCNP in general, and specifically for:

- a) assigning group members to the BoD,
- b) approving, concurrent with the Monte Carlo Team and the BoD, all changes to MCNP beyond regular maintenance.

The User Community may:

- a) make suggestions for features to be added to the features list,
- b) report bugs found to the Monte Carlo Team.

### III. DOCUMENTATION

The following documents control the development of MCNP:

- a) The MCNP features and bug lists.
- b) Chapter 2 of the MCNP Manual.<sup>3</sup> This section of the MCNP manual describes the functions, performance criteria, design constraints, and attributes of MCNP. It also describes the components and subcomponents of the MCNP software design, including data bases and internal interfaces. The external user interface is described in Chapter 3. The MCNP manual is updated at each major version.
- c) Patch documentation. All features added since the last publication of the MCNP manual are documented in LANL memoranda and are referenced in the major patch converting the previous version of MCNP to the current version. See Fig. 7 for an example of a LANL memo documenting a patch.
- d) The MCNP Software Verification and Validation Plan (SVVP) (see Appendix A).
- e) The MCNP Software Verification and Validation Report. This Report is documented in Fig. 6, a sample letter releasing a new major version of the code to RSIC.

- f) The MCNP Manual. User documentation is contained in the MCNP manual.
- g) The MCNP Software Configuration Management Plan (see Appendix B).

See Appendix C for a cross reference between the MCNP SQA controlling documents and the minimum documentation required by IEEE 730.1.

**Los Alamos**  
NATIONAL LABORATORY  
**memorandum**

*Applied Theoretical & Computational Physics Division  
XTM, Transport Methods Group*

*To/MS: Monte Carlo Team Leader, XTM  
From/MS: MCNP™ Code Developer, XTM  
Phone/FAX: 5/6789/5-5538  
Symbol: XTM-yy-xxx  
Date: Month, Day, Year*

**MCNP4XN DOCUMENTATION**

This memo describes the required documentation accompanying the MCNP4b patch MNC4XN.

**Software Requirements Specifications**

Put the software requirements specification documentation here.

**Software Design Description**

Put the software design description here.

**User Interface**

Describe the User Interface Here.

**Testing and Validation**

Describe the testing and validation of the Patch here.

---

MCNP is a trademark of the Regents of the University of California, Los Alamos National Laboratory.

**Fig. 7. Sample Memo Describing Patch Documentation**

#### **IV. STANDARDS, PRACTICES, CONVENTIONS, AND METRICS**

This section identifies the standards, practices, conventions, and metrics to be applied to the development of MCNP, and identifies how compliance with these items is to be monitored and assured.

##### **A. Documentation Standards**

Patch file commentary must reference the appropriate LANL memoranda and/or other reference, and include the date and initials of the developer. All patch files are reviewed by the Monte Carlo Team and the BoD after implementation into the code. This review is documented by LANL memo.

##### **B. Logic Structure Standards**

The ANSI C and Fortran 77 standards are used. All code is compiled with ANSI C and Fortran 77 standard compilers, thus assuring the language standard.

##### **C. Coding Standards**

MCNP is programmed in the style of Dr. Thomas N. K. Godfrey, the principal MCNP programmer from 1975-1989. The Fortran used strictly adheres to the ANSI Fortran 77 standard. Variable dimensions for arrays are achieved by massive use of EQUIVALENCE statements and offset indexing. All variables local to a routine are no more than two characters in length, and all COMMON variables are between three and six characters in length. The principal characteristic of Tom Godfrey's style is its terseness. All patches accepted for inclusion in MCNP are put in Godfrey style during the integration and implementation step by MCNP code developers.

##### **D. Commentary Standards**

The MCNP patch file has a comment for every change in the code from one major version to another. For absolutely trivial and obvious changes, the comment in the patch file is sufficient. Variable and array names are documented in the MCNP manual.

##### **E. Testing Standards and Practices**

MCNP testing is done under the auspices of the SVVP; see Appendix A.



## **F. Selected Software Quality Assurance Product and Process Metrics**

Not applicable.

## **V. REVIEWS AND AUDITS**

### **A. Purpose**

This section defines the technical and managerial reviews and audits to be conducted, how they are to be accomplished, and what further actions are required to see that they are implemented and verified.

### **B. Feature Reviews**

All features and other changes to MCNP must be placed on the MCNP features or bug list, except for trivial code maintenance items (such as deleting references to CTSS and other obsolete systems, removing blank lines, etc.). Approval from the MCNP BoD is required before features can be accepted for integration into MCNP. All memoranda describing the proposed changes and changes to proposed features are circulated through the XTM Group Office for optional Group Office review. All BoD meeting notes and dated features lists are stored archivally.

This review is more of a management than a technical review, and relies on the expertise and experience of the XTM in determining whether a feature is desirable and implementable with the current resources and budget. The outcome of this review is documented as acceptance or rejection of the feature on the features list.

### **C. Intermediate Version Patch and Patch Documentation Review**

All patches to MCNP are reviewed by the Monte Carlo Team and the Board of Directors before and after implementation into intermediate and major versions of the code. The Monte Carlo Team Leader of the Transport Methods Group certifies that intermediate and major version patches to MCNP meet all software requirements specifications and are properly designed and implemented in MCNP. The Team Leader also reviews the documentation of intermediate and major version patches. This patch documentation must include the software requirements specifications, describe the software design, specify the user interface, and describe the testing and validation of the patch.

This review is both technical and managerial, and relies on the expertise of the Monte Carlo Team. It is documented by memoranda; see Fig. 4 for a sample of this review documented on the patch release memo.

#### **D. Coding Reviews and Audits**

Coding changes are multiply reviewed. Every line of code is reviewed by both the patch originator and by a separate code developer integrating the patch into an intermediate MCNP version. This review takes place at the same time as patch integration and serves as a functional audit.

When a new intermediate version of MCNP is ready for customer release, every change from the previous version is again reviewed by either the principal MCNP programmer or the Monte Carlo Team leader. This review applies to the intermediate version documentation memo as well and is a physical audit.

The Monte Carlo Team Leader is responsible for ensuring that every line of coding in MCNP is multiply reviewed. The Monte Carlo Team Leader certifies on the memo releasing the intermediate version for customers that these versions have passed these audits. See Fig. 4 for an example of this memo.

#### **E. Documentation Reviews**

The MCNP manual is reviewed by all members of the Monte Carlo Team and additional qualified LANL staff who are on the MCNP BoD. The Monte Carlo Team Leader certifies on the memo releasing the MCNP manual that the new version has passed this review. See Fig. 8 for an example of this memo.

#### **F. Cross Reference**

See Appendix D for a cross reference between the MCNP SQA reviews and the minimum reviews and audits required by IEEE 730.1.

# Los Alamos

NATIONAL LABORATORY

## memorandum

*Applied Theoretical & Computational Physics Division  
XTM, Transport Methods Group*

To/MS: Distribution

From/MS: Monte Carlo Team Leader, XTM

Phone/FAX: 5-6789/5-5538

Symbol: XTM-yy-xxx

Date: Month, Date, Year

### MCNP4B MANUAL UPDATE

This memo announces the release of the MCNP<sup>TM</sup> manual version 4B. The manual has been properly reviewed and approved by the Monte Carlo Team and the MCNP Board of Directors. New features described in the manual include:

*Put new feature info here*

**Fig. 8. Sample MCNP Manual Release Memo**

## VI. TEST

All SQA tests for MCNP are described in the SVVP (see Appendix A).

In addition, a number of benchmark calculations have been performed on MCNP to ensure agreement with physical experiments. The benchmarking program is an ongoing and collaborative effort, and a number of benchmark documents are available from LANL, General Electric, and Westinghouse, who have all done MCNP benchmarking. These benchmarks are:

- 1) MCNP: Photon Benchmark Problems, Daniel J. Whalen, David E. Hollowell, John S. Hendricks, LA-12196, Los Alamos National Laboratory, Sept. 1991.
- 2) MCNP: Neutron Benchmark Problems, Daniel J. Whalen, et.al, LA-12212, Los Alamos National Laboratory, Nov. 1991.
- 3) MCNP: Criticality Safety Benchmark Problems, John C. Wagner, James E. Sisolak, Gregg W. McKinney, LA-12415, Los Alamos National Laboratory, Oct. 1992.
- 4) Benchmark Analysis of MCNP ENDF/B-VI Iron, John D. Court, Ronald C. Brockhoff, John S. Hendricks, LA-12884, Los Alamos National Laboratory, Dec, 1994.
- 5) Comparison of First-Principles of MCNP Calculations of NAI and BGO Detector Response Functions to Measurements, Guy P. Estes, John T. Kriese, Robert G. Schrandt, LA-12391, Los Alamos National Laboratory, Sept. 1992.
- 6) Lawrence Livermore Pulsed Sphere Benchmark Analysis of MCNP ENDF/B-VI, John D. Court, Ronald C. Brockhoff, John S. Hendricks, LA-12885, Los Alamos National Laboratory, Dec. 1994.
- 7) MCNP ENDF/B-VI Validation: Infinite Media Comparisons of ENDF/B-VI and ENDF/B-V, John D. Court, John S. Hendricks, Stephanie C. Frankle, LA-12887, Los Alamos National Laboratory, Dec. 1994.

The above benchmarks are part of a coordinated MCNP benchmarking effort. In addition, many laboratories throughout the world benchmark MCNP for their own purposes, and the scientific literature includes 10-30 MCNP benchmarks per year by other organizations. These are not part of the MCNP SQAP, but they do provide confidence in the code.

## VII. PROBLEM REPORTING AND CORRECTIVE ACTION

All suspected problems with MCNP should be reported to the Monte Carlo Team of the LANL Transport Methods Group. The e-mail address is `mcnp@lanl.gov`. All reported problems are examined; those that are not user error and are nontrivial are logged into the MCNP bug list and investigated. Trivial bugs (incorrect spelling in the code, etc.) may be added to the patch immediately without further documentation. Cash awards are given as an incentive to get users to report problems. Bug reports are sent to an e-mail distribution list periodically.

Corrective action is logged into the MCNP bug list and implemented in the MCNP patch for the next version of the code. For all but the most obvious corrections, a memo is also prepared describing the problem fix, consequences, and any possible work-arounds; this memo is referenced in the MCNP bug list.

Problems identified in the software development and maintenance process are the responsibility of the Monte Carlo Team Leader, who is also ultimately responsible for software problem reporting and corrective action.

## VIII. TOOLS, TECHNIQUES, AND METHODOLOGIES

MCNP patches are written in the 'update' format that can be utilized by commercial software products such as Opcode\* Historian or a short preprocessing utility called `prpr` that is provided with the code.

## IX. CODE CONTROL

Major versions of MCNP released to RSIC are controlled by RSIC. Intermediate versions and documentation are controlled by the Monte Carlo Team. They are stored on the Los Alamos Common File System, with password protection where appropriate, and on a restricted access workstation network.

## X. MEDIA CONTROL

Major versions of MCNP are delivered to RSIC where they are stored upon RSIC media according to RSIC procedures.

---

\*Opcode, Inc., Austin, Texas

## **XI. SUPPLIER CONTROL**

MCNP is self-contained and does not depend upon supplier software beyond a standard ANSI Fortran 77 compiler and a standard C compiler, graphics libraries, standard Fortran and C math libraries, and PVM software for distributed processor multitasking.

## **XII. RECORDS COLLECTION, MAINTENANCE, AND RETENTION**

All SQA documentation is maintained and retained by the LANL Transport Methods Group.

## **XIII. TRAINING**

No training activities are necessary to meet the needs of the SQAP.

## **XIV. RISK MANAGEMENT:**

Since MCNP is not a commercial code and is not subject to specific cost and schedule constraints, this section is not applicable. Technical quality is, of course, dependent on the expertise of the XTM group, and therefore no special techniques are used to manage the risk of technical inadequacy.

## REFERENCES

1. "IEEE Software Engineering Standards Collection," Institute of Electrical and Electronics Engineers, Inc., 345 East 47th Street, New York, NY 10017-2394 (April 5, 1991).
2. ISO (International Organization for Standards), "ISO 9000—International Standards for Quality Management," 2nd Edition, ISO Central Secretariat, Case postale 56, CH-1211 Geneve 20, Switzerland (1992).
3. J. F. Briesmeister, Ed., "MCNP—A General Monte Carlo N-Particle Transport Code, Version 4A," Los Alamos National Laboratory report, LA-12625-M (November 1993).
4. Ronald C. Brockhoff, John S. Hendricks, "A New MCNP Test Set," Los Alamos National Laboratory Report LA-12839 (September 1994).

## APPENDIX A

### MCNP Software Verification and Validation Plan.

#### I. PURPOSE

The Purpose of the MCNP Software Verification and Validation Plan is to describe the methods used to verify that a) software requirements have been approved by an appropriate authority, b) the requirements have been implemented in the design, and c) the design is implemented correctly by the code. It also describes the methods used to validate that when the code is executed, it complies with the software requirements.

#### II. VERIFICATION

##### A. Approval of Requirements

All intermediate and major version patches to MCNP must be accompanied by documentation. (See Fig. 7 for an example.) This documentation must describe the software requirements specifications. The patch, along with its documentation, must be approved by consensus of the Group Office, MCNP BoD, and the Monte Carlo Team. The Monte Carlo Team Leader of the Transport Methods Group shall certify that patches to MCNP meet all software requirements specifications.

##### B. Approval of Design

All intermediate and major version patches to MCNP must be accompanied by documentation. (See Fig. 7 for an example.) This documentation must describe the software design and show how the design implements the requirements specification. The patch along with its documentation must be approved by consensus of the Group Office, MCNP Board of Directors, and the Monte Carlo Team. The Monte Carlo Team Leader of the Transport Methods Group shall certify that patches to MCNP meet all software requirements specifications and are properly designed.



### C. Approval of Implementation

All intermediate and major version patches to MCNP are reviewed by the Monte Carlo Team and the Board of Directors both before and after implementation into intermediate and major versions of the code. Coding changes must be multiply reviewed. Every line of code is reviewed by both the patch originator or a Monte Carlo Team member and by a separate Monte Carlo Team code developer assigned to integrate the patch into an intermediate MCNP version. The Monte Carlo Team Leader of the Transport Methods Group shall certify that patches to MCNP meet all software requirements specifications and are properly designed and implemented in MCNP.

### III. VALIDATION

All new features incorporated into MCNP are validated by test. This test set is described in Ref. 4. These features, after being integrated into an intermediate version of MCNP, must:

- a) pass the MCNP test set for the previous patch version to ensure that they do not affect unrelated parts of the code, and
- b) pass the MCNP test set modified to include the new feature.

To 'pass' the test set means that by running the test problems, it is shown that MCNP incorporates the requirements that the test set is designed to measure, reproducing the results exactly when the same random number seed is used.

Each bug correction shall result in a modification of the MCNP test set so that had the test problems been so modified, they would have caught the bug that was corrected. Thus by design, each bug fix causes all old versions of MCNP to fail the new test set. All changes to the test set will be documented in the test set documentation.

Intermediate versions of MCNP shall be provided to the approximately 200 MCNP users at Los Alamos and some to customers outside Los Alamos, so that MCNP is run on a wide variety of problems many thousands of times before release to RSIC.

## APPENDIX B

### MCNP Software Configuration Management Plan

#### I. PURPOSE

The purpose of the MCNP Software Configuration Management Plan is to describe the methods of configuration identification, control, and status accounting that apply to the MCNP software development process.

#### II. SCOPE

The MCNP software configuration management plan applies only to the MCNP Fortran and C source codes. Auxiliary codes, update memos, data libraries, system libraries, and documentation, etc., are not covered.

#### III. CONFIGURATION IDENTIFICATION

A major version of MCNP is released through the Radiation Shielding Information Center in Oak Ridge, Tennessee, approximately every 2-3 years. Major versions of MCNP are uniquely identified as "MCNPX" with X incrementing numerically and/or alphabetically. Major versions of MCNP have been approved for release to RSIC by consensus between the Monte Carlo Team, the Board of Directors, and the Group Office. The major versions of MCNP and their release dates have been:

<u>RELEASE DATE</u>	<u>VERSION NAME</u>
8/77	MCNP1A
5/78	MCNP1B
9/79	MCNP2
12/80	MCNP2B
5/82	MCNP2C
2/83	MCNP2D
9/83	MCNP3
9/85	MCNP3A
8/88	MCNP3B
3/91	MCNP4
10/93	MCNP4A

Intermediate versions of MCNP are those revisions of a major version that include new features but have not been released to RSIC. Intermediate versions of MCNP are uniquely identified with a unique version name like "MCNPXK," with MCNPX the major version, and K incrementing alphabetically. Intermediate versions of MCNP also have a unique load date. Intermediate versions of MCNP have been approved for release to customers by the leader of the Monte Carlo Team.

Developmental versions of MCNP are "work in-progress" versions of the code. They are not to be distributed outside the Monte Carlo Team. They are identified by the MCNP intermediate version number that they modify, but with a different load date. The load date must be printed every time the code is executed.

One of the principal attractions of MCNP is that it can be easily modified by users for their unique needs. Appendix C of the MCNP manual describes how to modify MCNP. These user-modified versions of MCNP are not covered by the MCNP SQAP, nor are they subject to MCNP configuration management.

#### IV. CONFIGURATION CHANGE CONTROL

All changes to intermediate and major versions of the code are made by implementing approved patches. When the Monte Carlo Team decides that an intermediate version is ready to become a major version of MCNP, approval is received from both the MCNP BoD and the Group Office concurrently. Then the intermediate version is "frozen" and the addition of new features is prohibited. After sustained use by friendly users, the Monte Carlo Team will determine that the code has demonstrated sufficient robustness for international release. Then, with the approval of the MCNP BoD and the Group Office, the last intermediate version is renamed as the new major version, frozen, and sent to RSIC.

A major version of MCNP is archival and is not to be modified. If significant errors are discovered in a major version, either

- 1) a corrected version will be sent to RSIC for international distribution or
- 2) a correction patch or install.fix file (see Appendix C of the MCNP manual) will be sent to RSIC and made available electronically so that MCNP may be reinstalled with the correction or
- 3) a work-around will be sent to customer users and documented for later distribution to all users. (A work-around is a message to users on how to avoid the problem.)

If a corrected version or correction patch is distributed, the MCNP version will be renamed.

All intermediate and major version patches are documented. The documentation must describe the software requirements specifications, describe the software design, specify the user interface, and describe the testing and validation of the patch. This documentation should be appropriate for inclusion in chapters 2 (physics) and 3 (user interface) of the MCNP manual. In the patch, the revision must include a commentary describing the patch, giving the date it was implemented, and referencing the patch documentation.

At each new major version of MCNP, the MCNP manual must be revised accordingly.

## **V. CONFIGURATION STATUS ACCOUNTING**

The configuration status of MCNP is documented in the features list. The features list records whether the feature has been approved, disapproved, or is a new feature and, for approved features, whether work is underway or is finished. If the work is finished, the date and version number are listed. The major versions of MCNP are documented in the MCNP manual.

## **VI. RESPONSIBILITIES**

The Monte Carlo Team is responsible for software configuration management for MCNP.

## **APPENDIX C**

### **Cross Reference Between MCNP SQA Controlling Documents and the Minimum Documentation Required by IEEE 730.1**

#### **I. SOFTWARE REQUIREMENTS SPECIFICATION**

The software requirements specification for the current major RSIC-released version of MCNP is Chapter 2 of the MCNP manual. Intermediate and major version patch documentation describes the software requirements specification for each individual patch.

#### **II. SOFTWARE DESIGN DESCRIPTION**

The software design description (SDD) for the current major RSIC-released version of MCNP is in Chapter 2 of the MCNP manual. Intermediate and major version patch documentation describe the design of each individual patch.

#### **III. SOFTWARE VERIFICATION AND VALIDATION PLAN (SVVP)**

See Appendix A.

#### **IV. SOFTWARE VERIFICATION AND VALIDATION REPORT (SVVR)**

The Monte Carlo Team Leader shall certify by LANL memorandum that each major release version of MCNP to RSIC meets the SVVP. Figure 6 (sample letter releasing a new version to RSIC) contains this certification.

#### **V. USER DOCUMENTATION**

The MCNP manual specifies and describes the required MCNP data and control inputs, input sequences, options, program limitations, and other activities and items necessary for successful execution of MCNP.

#### **VI. SOFTWARE CONFIGURATION MANAGEMENT PLAN (SCMP)**

See Appendix B.

## **APPENDIX D**

### **Cross Reference Between the MCNP SQA Review and Audits and the Minimum Reviews and Audits Required by IEEE 730.1**

#### **I. PURPOSE**

This section describes the minimum set of reviews and audits required by IEEE 730.1 and explains how the MCNP SQA reviews and audits fulfill these requirements.

#### **II. SOFTWARE REQUIREMENTS REVIEW**

A Software Requirements Review ensures the adequacy of the requirements stated in the software requirements specification. The MCNP review that accomplishes this function is the Patch and Patch Documentation Review.

#### **III. PRELIMINARY DESIGN REVIEW**

The Preliminary Design Review evaluates the technical adequacy of the preliminary design of the software as depicted in the preliminary software design description. The MCNP review that accomplishes this function is the Patch and Patch Documentation Review.

#### **IV. CRITICAL DESIGN REVIEW**

The Critical Design Review determines the acceptability of the detailed software designs, as depicted in the detailed software design description, in satisfying the requirements of the software requirements specification. The MCNP review that accomplishes this function is the Patch and Patch Documentation Review.

#### **V. SOFTWARE VERIFICATION AND VALIDATION PLAN REVIEW**

The Software Verification and Validation Plan Review evaluates the adequacy and completeness of the verification and validation methods defined in the SVVP. Since the MCNP SVVP is Appendix A of the MCNP SQAP, it is reviewed at the same time as the SQAP.

## **VI. D6 FUNCTIONAL AUDIT**

A functional audit is held prior to software delivery to verify that all requirements specified in the software requirements specification have been met. The MCNP review that accomplishes this function is the Coding Review and Audit.

## **VII. D7 PHYSICAL AUDIT**

A Physical Audit is held to verify that the software and its documentation are internally consistent and are ready for delivery. The MCNP Review that accomplish this function is the Coding Review and Audit.

## **VIII. IN-PROCESS AUDITS**

An in-process audit is held to verify consistence of design. The MCNP review that accomplishes this function is the Features review.

## **IX. MANAGERIAL REVIEWS**

Managerial reviews assess the execution of all of the actions and the items identified in the SQAP. The MCNP review that accomplishes this is a Group-Office-directed audit of the software quality assurance program for MCNP.

## **X. SOFTWARE CONFIGURATION MANAGEMENT PLAN REVIEW**

This review evaluates the adequacy and completeness of the configuration management methods defined in the SCMP. Since the SCMP is part of the SQAP, it is reviewed along with the SQAP.

## **XI. POST MORTEM REVIEW**

A Post Mortem Review is held at the conclusion of the project to assess the activities implemented on the project and to provide recommendations of appropriate actions. This review is not appropriate to the MCNP software development process, since it is an iterative, on-going process and is not concluded.



## APPENDIX E

### Cross Reference Between the MCNP SQAP, IEEE 730.1, and ISO-9000-3

**TABLE I: DOCUMENT AND STANDARD CROSS REFERENCE**

MCNP SQAP		IEEE 730.1	ISO 9000-3
1.	Purpose	3.1	5.5.1
1.1	Plan Reviews	3.6.2.4,3.6.2.8,3.6.2.9	4.1.1.3
2.	Reference Documents	3.2	not applicable
3.	Management	3.3	4.1.1.2.1,4.1.1.2.3,5.4.2.2
3.1	Organization	3.1	not applicable
3.2	Tasks	3.3.2,3.4.2	5.1.5.4.1,5.4.2.1
3.2.1	Concept Exploration	3.3.2	not applicable
3.2.2	Requirements & Design	3.3.2	5.3.1,5.6.2
3.2.3	Implementation	3.3.2	not applicable
3.2.4	Test	3.3.2	not applicable
3.2.5	Installation & Checkout	3.3.2	not applicable
3.2.6	Operation & Maintenance	3.3.2	5.10.5,5.10.6
3.2.7	Retirement	3.3.2	not applicable
3.3	Responsibilities	3.3.3	not applicable
4.	Documentation	3.4.3,4.1.3,4.2.1,3.4.2.2,3.4.2.5	5.4.4,5.4.5
5.	Standard, Practices, Conventions, and Metrics	3.5.3,5.1	5.6.3
5.1	Documentation standards	3.5.2	not applicable
5.2	Logic structure standards	3.5.2	not applicable
5.3	Coding standards	3.5.2	not applicable
5.4	Commentary standards	3.5.2	not applicable
5.5	Testing standards and practices	3.5.2	not applicable
5.6	Selected software quality assurance product and process metrics	3.5.2	not applicable
6.	Reviews and Audits	3.6	4.3,5.4,3,5.6.4
6.1	Purpose	3.6.1	not applicable
6.2	Features Review	3.6.2.7	not applicable

TABLE I: DOCUMENT AND STANDARD CROSS REFERENCE (cont.)

MCNP SQAP		IEEE 730.1	ISO 9000-3
6.3	Intermediate Version Path and Patch Documentation Review	3.6.2.1,3.6.2.2,3.6.2.3	not applicable
6.4	Coding Reviews and Audits	3.6.2.5,3.6.2.6	not applicable
6.5	Documentation Reviews	3.6.3	not applicable
6.6	Cross Reference	3.6.2	not applicable
7.	Test	3.7	5.7.1
8.	Problem Reporting and Corrective Action	3.8	4.4
9.	Tools, techniques, and methodologies	3.9	5.4.2,3,6.6
10.	Code control	3.10	not applicable
11.	Media control	3.11	not applicable
12.	Supplier control	3.12	not applicable
13.	Records collection, maintenance, and retention	3.13	not applicable
14.	Training	3.14	6.9
15.	Risk Management.	3.15	not applicable
A.	MCNP Software Verification and Validation Plan	3.4.2.3	4.1.1,2.2,5,4.6
B.	MCNP Software Configuration Management Plan	3.4.2.6	6.1.1,6.1.2,6.1.3.1,6.1.3.2,6.1.3.3
C.	Cross Reference between MCNP SQA controlling documents and the minimum documentation required by IEEE 730.1	3.6.3	not applicable
D.	Cross reference between the MCNP SQA reviews and audits and the minimum reviews and audits required by IEEE 730.1	3.6.2	not applicable
E.	Cross reference between the MCNP SQAP, IEEE 730.1, and IEEE 9000-3	not applicable	not applicable
F.	Definitions and Acronyms	not applicable	not applicable
G.	Figures and Tables	not applicable	not applicable

## APPENDIX F

### Definitions and Acronyms

Benchmark	- The process of reviewing software requirements and/or implementation to ensure that the models which the requirements describe are consistent with the physical reality they are intended to portray.
BoD	- MCNP Board of Directors
CFS	- Common File System in the LANL Integrated Computer Network
Developmental Version	- "work in-progress" version of the code, not released to users
Group Office	- XTM management consisting of the Group Leader and Deputy Group Leader.
IEEE	- Institute of Electrical and Electronics Engineers
Intermediate Version	- those revisions of a major version that include new features but have not been released to RSIC
ISO	- International Organization for Standardization
LANL	- Los Alamos National Laboratory
Major Version	- version released to RSIC for international distribution
MCNP	- Monte Carlo N-Particle radiation transport code
Patch	- a file in 'update' utility format that changes one version of MCNP to another
RSIC	- Radiation Shielding Information Center
SCMP	- Software Configuration Management Plan
SQA	- Software Quality Assurance
SQAP	- Software Quality Assurance Plan
SVVP	- Software Verification and Validation Plan

SVVR - Software Verification and Validation Report

Validation (for software) - The process of evaluating software to ensure compliance with requirements. This process can include the requirements to be as close as possible to physical benchmarks, but it can also include software requirements that have no relation to the physical world (for example, the requirement could be that the software must include PVM multi-tasking.)

Verification (for software) - The process of evaluating the products of a given phase to ensure correctness and consistency with respect to the products and standards provided as input to that phase

XTM - LANL Transport Methods Group

TABLE II: MCNP TASKS

	Monte Carlo Team	Board of Directors	Group Office	Documentation
<b>Concept Exploration</b>				
• Compile Features List	X			Features list, stored archivally on CFS
• Features Review				
- Approve or disapprove features for inclusion		X		Acceptance or Rejection documented on Features List
- Prioritize features		X		documented on the features list
<b>Requirements &amp; Design</b>				
• Patch Review				
- Check Patch requirements & design to see if they exist		X		documented by LANL memo
- Make recommendations about additional requirements & design		X		documented by LANL memo
- Review patch for correctness; does the design implement the requirements?	X			documented by LANL memo
- Review Patch documentation for completeness	X			documented by LANL memo
• Develop patch requirements & design	X			documented in patch documentation
• Document patch requirements & design	X			by LANL memo
• Approve patches & patch documentation	X	X	X	by LANL memo
<b>Implementation</b>				
• Implement Patches	X			in patch commentary
• Coding Audit/Review	X			by LANL memo
• Review patch commentary	X			by LANL memo

TABLE II: MCNP TASKS (cont.)

	Monte Carlo Team	Board of Directors	Group Office	Documentation
<b>Test</b>				
• Run the MCNP test set on the patch; correct code until the patch patches the test set	X			not necessary
• Modify the test set so that the new feature is tested	X			in test set documentation
<b>Installation &amp; Checkout</b>				
• Install MCNP & run test set	X			by LANL memo to user
<b>Operation &amp; Maintenance</b>				
• Compile & Maintain Bug List	X			bug list, stored archivally on CFS
• Investigate Bug Claims	X			in bug list
• Implement Appropriate Bug Fixes	X			in patch commentary
<b>Retirement</b>				
• Approve major version release	X	X	X	by LANL memo

**S E C T I O N 6**

# Los Alamos

NATIONAL LABORATORY

## memorandum

*Applied Theoretical & Computational  
Physics Division  
Transport Methods Group, XTM  
Los Alamos, New Mexico 87545*

*To/MS: Distribution  
From/MS: S. Frankle, XTM / MS B226  
Phone/FAX: 5-6461 / 5-5538  
Symbol: XTM:SCF-97-29  
Date: Feb. 12, 1997*

### **SUBJECT: Compiling MCNP Version '4B' on VMS**

This memorandum discusses compiling MCNP on VMS systems with CGS and X11 graphics. Minimal changes were required for compiling with CGS graphics, while more extensive changes were required for compiling with X11 graphics. I have created a subdirectory on CFS, /x6data/public/mcnp4b, where VMS specific files have been stored. Files specific to X11 graphics version are under the subdirectory 'x11' and files specific to the test problems are under the subdirectory 'test'

#### **Compiling with CGS graphics**

There were a number of files that required updating for compiling MCNP on VMS systems: The INSTALL.COM, RUNPROB.VMS, and the MCTAL and OUTP files for the test problems all required updating. The INSTALL.COM file simply needed updating to reference the new TESTDIR. and TESTLIB1. files, and is stored on CFS as INSTALL.VMS and is included at the end of this memorandum. Most of the effort required for compiling with CGS graphics concerned the test problems.

The input files for the test problems were provided in a tar format which is not useable by VMS systems without additional software. Additionally, the names of the input files had to be converted to VMS format. I also had to make extensive changes to the RUNPROB command file, or script, for the VMS system. A backup save set has been produced for the input problems, TESTINP.VMS and stored on CFS. The new RUNPROB.VMS file is also stored on CFS and included at the end of this memorandum. As there were no standard OUTP and MCTAL files for comparison purposes, it was suggested that I use the Sun workstation version for comparison. There were differences between the VMS and Sun files. After a review of the differences with John Hendricks, it was determined that all the differences were reasonable. The VMS produced MCTAL and OUTP files were renamed and backup save sets created and stored on CFS.

The final executable for MCNP4B with CGS graphics is stored on CFS as mcnp4b\_cgs.vms. The default DATAPATH has been used during compilation. The user may set his DATAPATH by including the following line in his LOGIN.COM file with the appropriate disk and directory names:

```
$ assign disk_name:[directory_name]xmdir. xmdir
```

The first line of the XSDIR. file should then have the proper DATAPATH set such as in the following example:

```
datapath dka200:[mcnp.xsect]
```



### Compiling with X11 Graphics

An informal memorandum documenting the steps necessary to compile MCNP 4A on VMS using X11 graphics was provide at the Monte Carlo Team's request in August of 1995.<sup>1</sup> I basically have performed the same procedures described in this previous memorandum for compiling MCNP version 4B on a Dec Alpha running VMS [OpenVMS AXP (TM) Operating System, Version V6.1]. Some of the bugs/problems reported in reference 1 have been included in 4B, while other have not. I will discuss each step of the process in detail; the INSTALL package, MCNPC.C, MCNP.FOR, linking the object files, and executing the test problems. The CFS subdirectory, /x6data/public/mcnp4b/x11 contains the following files:

mcnpc.c	mcnp.for	patchf.dat
patchc.dat	makemcnp.com	xlink.opt

### INSTALL Package

The INSTALL package is not compatible with VMS and X11 graphics at the present time. It is used only for the purpose of separating the PATCH.DAT file into the individual files necessary for compiling, PATCHF.DAT and PATCHC.DAT. For this initial release of version 4B, there is no PATCH.DAT file. The MAKEMCNP.COM file that was produced for compiling MCNP version 4B was then edited. As it is necessary to make some small changes to both MCNPC.C and MCNP.FOR, one cannot simply run the MAKEMCNP.COM file as you must edit each of those two programs after running PRPR to include the patches. I have included comment lines the command file for this purpose. Should the necessary changes be incorporated into the INSTALL.FIX patches, no editing would be required and the command file would function properly and the comment lines can be removed. The contents of the revised MAKEMCNP.COM file are as follows:

```

$ ! COM file to make MCNP 4B on Open VMS with X11 graphics.
$ ! Files needed: prpr.id,makxs.id,patchf.dat,patchc.dat,mcnpc.id,mcnpf.id,
$ ! and xlink.opt
$ set verify
$ set noon
$ assign testdir. xsdir
$ assign testlib1. testlib1
$ del compile.dat;,newid.dat;,patch.dat;
$ copy prpr.id prpr.for
$ fortran prpr
$ link prpr
$ del prpr.for;,prpr.obj;
$ copy makxs.id codef.dat
$ search patchf.dat *define /output=patch.dat`
$ run prpr
$ rename compile.dat makxsf.for
$ for makxsf
$ link makxsf
$ del codef.dat;,patch.dat;,newid.dat;,makxsf.obj;
$ copy mcnpc.id codef.dat
$ copy patchc.dat patch.dat
$ run prpr
$ del codef.dat;,patch.dat;,newid.dat;
$ rename compile.dat mcnpc.c

```

```

$!
$! Edit the mcnpc.c file to make appropriate VMS changes.
$!
$ cc mcnpc
$ copy mcnpf.id codef.dat
$ copy patchf.dat patch.dat
$ run prpr
$ del codef.dat,patch.dat,newid.dat;
$ rename compile.dat mcnp.for
$!
$! Edit the mcnp.for file to make appropriate VMS changes.
$!
$ for mcnp
$ link mcnp, mcnpc, xlink/opt

```

### *MCNPC.C File*

There are number of changes that still need to be made in the MCNPC.C file after PRPR has been run; all other changes from reference 1 have been implemented. First, the following lines at the beginning of the code

```

#include <stdio.h>
#include <unistd.h>
#include <sys/types.h>
#include <sys/times.h>

```

need to be changed to

```

#include <stdio.h>
#include <unistd.h>
#include <types.h>
#include <time.h>

```

The unix style of specifying the filenames for `types.h` and `time.h` need to be removed, and the filename `times.h` needs to be changed to `time.h`.

Secondly, the functions CNINT, XEVENT, XGSTXFP, and XSCFONT need to be moved to the top of MCNPC.C prior to being called by other functions, otherwise the C compiler assume that they are implicit functions. I have placed these four functions after the global variables have been defined and just before the function XGOPWK. Replacement of the four functions should in no way affect the compilation on unix-based platforms and will only make the code more platform-independent.

### *MCNP.FOR*

There are two small changes required in the subroutine GTX of MCNP.FOR which have not been implemented to date. First, the line

```
h=h//char(0)
```

needs to be added immediately prior to the CALL XGTX statement. Secondly, the CALL XGTX needs to be modified from

```
call xgtx(h,n,x,y)
```

to

```
call xgtx(%ref(h),n,x,y)
```

This allows MCNP.FOR to call the MCNPC.C routines successfully. Note, that the /g\_floating option is the default for the Fortran compiler and is unnecessary to include in the MAKEMCNP.COM file. If a DIFFERENCES command is performed on the two MCNP.FOR files, one obtains the following result:

```
$ differ mcnp.for;2 mcnp.for;1
*****
File DKA200:[MCNP.MCNP4B]MCNP.FOR;2
110791      h=h//char(0)
110792      call xgtx(%ref(h),n,x,y)
110793      return
*****
File DKA200:[MCNP.MCNP4B]MCNP.FOR;1
110791      call xgtx(h,n,x,y)
110792      return
*****
```

The following warning message is still given during compilation as on other systems:

```
      if('A'.eq.'a')call expire(0,kod,'source code not lower case.')
      .....^
%FORT-I-NOPATH, No path to this statement
at line number 492 in file DKA200:[MCNP.MCNP4B]MCNP.FOR;2
```

It should be noted that for VMS systems the individual subroutines are not compiled as on unix platforms, but are contained within one large fortran file. If the system's paging file is not sized properly, compilation times can be as long as a few hours. Increasing the system's paging file size appropriately will dramatically decrease the compilation time (<30 minutes).

#### *Compiling the MCNP Executable*

One last step is now necessary to compile MCNP. The following command is executed

```
link mcnp, mcnpc, xlink/opt
```

where xlink/opt refers to the XLINK.OPT file in the local directory. This tells the compiler where to find all of the necessary libraries for linking the object files MCNP.OBJ and MCNPC.OBJ with the X11 libraries. Not every line of the XLINK.OPT file is necessary, but I have not taken the time to narrow down the list. The contents of the XLINK.OPT file are as follows:

```
sys$share:cda$access/share,-
sys$share:decw$d2dxlibshr/share,-
sys$share:decw$xextlibshr/share,-
sys$share:decw$xlibshr/share,-
sys$share:xdps$dpsbindingsshr/share,-
sys$share:xdps$dpsclientsshr/share,-
sys$share:xdps$dpslibshr/share,-
sys$share:xie$shrlib/share,-
sys$share:decw$ailshrr5/share,-
sys$share:decw$xmllibshrr5/share,-
```

```
sys$share:decw$xtaplibshr5/share,-  
sys$share:decw$xtlibshr5/share,-  
sys$share:ddif$viewshr12/share,-  
sys$share:decw$bkrshr12/share,-  
sys$share:decw$dxmllibshr12/share,-  
sys$share:decw$mrmlibshr12/share,-  
sys$share:decw$terminalshr12/share,-  
sys$share:decw$xmlibshr12/share,-  
sys$share:digit$libshr12/share,-  
sys$share:img$shrlib12/share,-  
sys$share:lwkdxmshr12/share,-  
sys$share:xnl$shr12/share
```

The final executable for MCNP4B with X11 graphics is stored on CFS as `mcnp4b_x11.vms`. One last note: to use MCNP with X11 graphics from a remote terminal, the following VMS command is entered where *your\_node* is your machine name or ip address and *x* is the screen you wish to use.

```
set display/create/transport=tcpip/node=your_node/screen=x
```

1 C. M. Frankle (NIS-6), "X-Windows Version of MCNP on OpenVMS," LANL internal memorandum to the Monte Carlo Team X-6, August 22, 1995.

## The INSTALL.COM file for VMS Systems

```

$ set noon
$ write sys$output "
$ write sys$output "%%%%%%%%%%%%%%%%%%%%%%%%%%%%%%%%%%%%%%%%%%%%%%%%%%%%%%%%%%%%%%%%%%%%%%%%%"
$ write sys$output "%                               Time          %"
$ write sys$output "% Run the SETUP program ...      (1-2 min.)    %"
$ write sys$output "%                               %"
$ write sys$output "%%%%%%%%%%%%%%%%%%%%%%%%%%%%%%%%%%%%%%%%%%%%%%%%%%%%%%%%%%%%%%%%%%%%%%%%%"
$ if (f$search("patchc.dat").nes."") then del patchc.dat;*
$ if (f$search("patchf.dat").nes."") then del patchf.dat;*
$ if (f$search("makemcnp.com").nes."") then del makemcnp.com;*
$ if (f$search("mcnp.for").nes."") then del mcnp.for;*
$ if (f$search("mcnp.obj").nes."") then del mcnp.obj;*
$ if (f$search("mcnp.exe").nes."") then del mcnp.exe;*
$ if (f$search("install.log").nes."") then del install.log;*
$ assign install.log sys$error
$ assign testdir. xsdir
$ assign testlib1. testlib1
$ fortran mcsetup.for
$ link mcsetup
$ del mcsetup.obj;
$ assign/user_mode sys$command: sys$input
$ run mcsetup
$ if (f$search("makemcnp.com").eqs."") then goto err1
$ if (f$search("answer.dat").nes."") then del answer.dat;*
$ rename install.ans answer.dat
$ write sys$output "
$ write sys$output "%%%%%%%%%%%%%%%%%%%%%%%%%%%%%%%%%%%%%%%%%%%%%%%%%%%%%%%%%%%%%%%%%%%%%%%%%"
$ write sys$output "%                               Time          %"
$ write sys$output "% Run the MAKEMCNP script ... (15-30 min.) %"
$ write sys$output "%                               %"
$ write sys$output "%%%%%%%%%%%%%%%%%%%%%%%%%%%%%%%%%%%%%%%%%%%%%%%%%%%%%%%%%%%%%%%%%%%%%%%%%"
$ assign install.log sys$output
$ @makemcnp
$ if $status
$ then
$   set noverify
$   deassign sys$output
$   if (f$search("runprob.vms").eqs."") then goto err2
$   write sys$output "
$   write sys$output "%%%%%%%%%%%%%%%%%%%%%%%%%%%%%%%%%%%%%%%%%%%%%%%%%%%%%%%%%%%%%%%%%%%%%%%%%"
$   write sys$output "%                               Time          %"
$   write sys$output "% Run the test problems ... (20-40 min.) %"
$   write sys$output "%                               %"
$   write sys$output "%%%%%%%%%%%%%%%%%%%%%%%%%%%%%%%%%%%%%%%%%%%%%%%%%%%%%%%%%%%%%%%%%%%%%%%%%"
$   backup testinp.vms/save *
$   backup testmctl.vms/save *
$   backup testoutp.vms/save *
$   copy runprob.vms runprob.com
$   assign install.log sys$output
$   @runprob
$   if $status
$   then
$     set noverify
$     deassign sys$output
$     write sys$output "
$     write sys$output "%%%%%%%%%%%%%%%%%%%%%%%%%%%%%%%%%%%%%%%%%%%%%%%%%%%%%%%%%%%%%%%%%%%%%%%%%"
$     write sys$output "%                               %"

```

```

$ write sys$output "% Installation complete - see Readme file. %"
$ write sys$output "%"
$ write sys$output "%%%%%%%%%%%%%%%%%%%%%%%%%%%%%%%%%%%%%%%%%%%%%%%%%%%%%%%%%%%%%%%%%%%%%%%%%"
$ else
$ set noverify
$ deassign sys$output
$ write sys$output "
$ write sys$output "%%%%%%%%%%%%%%%%%%%%%%%%%%%%%%%%%%%%%%%%%%%%%%%%%%%%%%%%%%%%%%%%%%%%%%%%%"
$ write sys$output "%"
$ write sys$output "% VERIFICATION ERROR - see INSTALL.LOG file. %"
$ write sys$output "%"
$ write sys$output "%%%%%%%%%%%%%%%%%%%%%%%%%%%%%%%%%%%%%%%%%%%%%%%%%%%%%%%%%%%%%%%%%%%%%%%%%"
$ endif
$ deassign sys$error
$ deassign xsdir
$ deassign testlib1
$ exit
$ else
$ set noverify
$ deassign sys$output
$ write sys$output "
$ write sys$output "%%%%%%%%%%%%%%%%%%%%%%%%%%%%%%%%%%%%%%%%%%%%%%%%%%%%%%%%%%%%%%%%%%%%%%%%%"
$ write sys$output "%"
$ write sys$output "% COMPILATION ERROR - see INSTALL.LOG file. %"
$ write sys$output "%"
$ write sys$output "%%%%%%%%%%%%%%%%%%%%%%%%%%%%%%%%%%%%%%%%%%%%%%%%%%%%%%%%%%%%%%%%%%%%%%%%%"
$ endif
$ deassign sys$error
$ deassign xsdir
$ deassign testlib1
$ exit
$ err1:
$ write sys$output "
$ write sys$output "%%%%%%%%%%%%%%%%%%%%%%%%%%%%%%%%%%%%%%%%%%%%%%%%%%%%%%%%%%%%%%%%%%%%%%%%%"
$ write sys$output "%"
$ write sys$output "% SETUP ERROR OR USER ABORT. %"
$ write sys$output "%"
$ write sys$output "%%%%%%%%%%%%%%%%%%%%%%%%%%%%%%%%%%%%%%%%%%%%%%%%%%%%%%%%%%%%%%%%%%%%%%%%%"
$ deassign sys$error
$ deassign xsdir
$ deassign testlib1
$ exit
$ err2:
$ write sys$output "
$ write sys$output "%%%%%%%%%%%%%%%%%%%%%%%%%%%%%%%%%%%%%%%%%%%%%%%%%%%%%%%%%%%%%%%%%%%%%%%%%"
$ write sys$output "%"
$ write sys$output "% VERIFICATION ERROR - missing RUNPROB file. %"
$ write sys$output "%"
$ write sys$output "%%%%%%%%%%%%%%%%%%%%%%%%%%%%%%%%%%%%%%%%%%%%%%%%%%%%%%%%%%%%%%%%%%%%%%%%%"
$ deassign sys$error
$ deassign xsdir
$ deassign testlib1
$ exit

```

## The RUNROB.COM (RUNPROB.VMS) file for VMS Systems.

```

$ mcnp name=inp01 xsdir=testdir.
$ differ inp01m.dat mctl01. /ignore=(trail,blank) /merged=0 /output=difm01
$ differ inp01o.dat outp01. /ignore=(trail,blank) /merged=0 /output=difo01
$ dele inp01r.dat;
$ mcnp name=inp02 xsdir=testdir. fatal
$ differ inp02m.dat mctl02. /ignore=(trail,blank) /merged=0 /output=difm02
$ differ inp02o.dat outp02. /ignore=(trail,blank) /merged=0 /output=difo02
$ dele inp02r.dat;
$ mcnp name=inp03 xsdir=testdir.
$ differ inp03m.dat mctl03. /ignore=(trail,blank) /merged=0 /output=difm03
$ differ inp03o.dat outp03. /ignore=(trail,blank) /merged=0 /output=difo03
$ dele inp03r.dat;
$ mcnp name=inp04 xsdir=testdir.
$ differ inp04m.dat mctl04. /ignore=(trail,blank) /merged=0 /output=difm04
$ differ inp04o.dat outp04. /ignore=(trail,blank) /merged=0 /output=difo04
$ dele inp04r.dat;
$ mcnp name=inp05 xsdir=testdir.
$ differ inp05m.dat mctl05. /ignore=(trail,blank) /merged=0 /output=difm05
$ differ inp05o.dat outp05. /ignore=(trail,blank) /merged=0 /output=difo05
$ dele inp05r.dat;
$ mcnp name=inp06 xsdir=testdir.
$ differ inp06m.dat mctl06. /ignore=(trail,blank) /merged=0 /output=difm06
$ differ inp06o.dat outp06. /ignore=(trail,blank) /merged=0 /output=difo06
$ dele inp06r.dat;
$ mcnp name=inp07 xsdir=testdir.
$ differ inp07m.dat mctl07. /ignore=(trail,blank) /merged=0 /output=difm07
$ differ inp07o.dat outp07. /ignore=(trail,blank) /merged=0 /output=difo07
$ dele inp07r.dat;
$ mcnp name=inp08 rssa=inp07w xsdir=testdir.
$ differ inp08m.dat mctl08. /ignore=(trail,blank) /merged=0 /output=difm08
$ differ inp08o.dat outp08. /ignore=(trail,blank) /merged=0 /output=difo08
$ dele inp08r.dat;
$ mcnp name=inp09 xsdir=testdir.
$ differ inp09m.dat mctl09. /ignore=(trail,blank) /merged=0 /output=difm09
$ differ inp09o.dat outp09. /ignore=(trail,blank) /merged=0 /output=difo09
$ mcnp name=inp10 xsdir=testdir.
$ differ inp10m.dat mctl10. /ignore=(trail,blank) /merged=0 /output=difm10
$ differ inp10o.dat outp10. /ignore=(trail,blank) /merged=0 /output=difo10
$ dele inp10r.dat;
$ mcnp name=inp11 xsdir=testdir. fatal
$ differ inp11m.dat mctl11. /ignore=(trail,blank) /merged=0 /output=difm11
$ differ inp11o.dat outp11. /ignore=(trail,blank) /merged=0 /output=difo11
$ dele inp11r.dat;
$ mcnp name=inp12 xsdir=testdir.
$ differ inp12m.dat mctl12. /ignore=(trail,blank) /merged=0 /output=difm12
$ differ inp12o.dat outp12. /ignore=(trail,blank) /merged=0 /output=difo12
$ dele inp12r.dat;
$ mcnp name=inp13 xsdir=testdir.
$ differ inp13m.dat mctl13. /ignore=(trail,blank) /merged=0 /output=difm13
$ differ inp13o.dat outp13. /ignore=(trail,blank) /merged=0 /output=difo13
$ dele inp13r.dat;
$ mcnp name=inp14 xsdir=testdir.
$ differ inp14m.dat mctl14. /ignore=(trail,blank) /merged=0 /output=difm14
$ differ inp14o.dat outp14. /ignore=(trail,blank) /merged=0 /output=difo14
$ dele inp14r.dat;
$ mcnp name=inp15 xsdir=testdir.
$ differ inp15m.dat mctl15. /ignore=(trail,blank) /merged=0 /output=difm15

```

```

$ differ inp15o.dat outp15. /ignore=(trail,blank) /merged=0 /output=difo15
$ dele inp15r.dat;
$ mcnp name=inp16 xsdir=testdir.
$ differ inp16m.dat mctl16. /ignore=(trail,blank) /merged=0 /output=difm16
$ differ inp16o.dat outp16. /ignore=(trail,blank) /merged=0 /output=difo16
$ dele inp16r.dat;
$ copy inp09s.dat srctp17.dat
$ mcnp name=inp17 s=srctp17 xsdir=testdir.
$ differ inp17m.dat mctl17. /ignore=(trail,blank) /merged=0 /output=difm17
$ differ inp17o.dat outp17. /ignore=(trail,blank) /merged=0 /output=difo17
$ dele inp17r.dat; , srctp17.dat;
$ mcnp name=inp18 xsdir=testdir.
$ differ inp18m.dat mctl18. /ignore=(trail,blank) /merged=0 /output=difm18
$ differ inp18o.dat outp18. /ignore=(trail,blank) /merged=0 /output=difo18
$ dele inp18r.dat;
$ mcnp name=inp19 xsdir=testdir.
$ differ inp19m.dat mctl19. /ignore=(trail,blank) /merged=0 /output=difm19
$ differ inp19o.dat outp19. /ignore=(trail,blank) /merged=0 /output=difo19
$ dele inp19r.dat;
$ mcnp name=inp20 xsdir=testdir.
$ differ inp20m.dat mctl20. /ignore=(trail,blank) /merged=0 /output=difm20
$ differ inp20o.dat outp20. /ignore=(trail,blank) /merged=0 /output=difo20
$ dele inp20r.dat;
$ mcnp name=inp21 xsdir=testdir.
$ differ inp21m.dat mctl21. /ignore=(trail,blank) /merged=0 /output=difm21
$ differ inp21o.dat outp21. /ignore=(trail,blank) /merged=0 /output=difo21
$ dele inp21r.dat;
$ mcnp name=inp22 rs=inp21w xsdir=testdir.
$ differ inp22m.dat mctl22. /ignore=(trail,blank) /merged=0 /output=difm22
$ differ inp22o.dat outp22. /ignore=(trail,blank) /merged=0 /output=difo22
$ dele inp22r.dat;
$ mcnp name=inp23 xsdir=testdir.
$ differ inp23m.dat mctl23. /ignore=(trail,blank) /merged=0 /output=difm23
$ differ inp23o.dat outp23. /ignore=(trail,blank) /merged=0 /output=difo23
$ dele inp23r.dat;
$ mcnp name=inp24 xsdir=testdir.
$ differ inp24m.dat mctl24. /ignore=(trail,blank) /merged=0 /output=difm24
$ differ inp24o.dat outp24. /ignore=(trail,blank) /merged=0 /output=difo24
$ mcnp name=inp25 run=inp24r CN
$ differ inp25m.dat mctl25. /ignore=(trail,blank) /merged=0 /output=difm25
$ differ inp25o.dat outp25. /ignore=(trail,blank) /merged=0 /output=difo25
$ dele inp24r.dat; , inp25r.dat;
$ mcnp name=inp26 wss=inp09w run=inp09r CN
$ differ inp26m.dat mctl26. /ignore=(trail,blank) /merged=0 /output=difm26
$ differ inp26o.dat outp26. /ignore=(trail,blank) /merged=0 /output=difo26
$ dele inp09r.dat;
$ mcnp name=inp27 rss=inp09w xsdir=testdir.
$ differ inp27m.dat mctl27. /ignore=(trail,blank) /merged=0 /output=difm27
$ differ inp27o.dat outp27. /ignore=(trail,blank) /merged=0 /output=difo27
$ dele inp27r.dat;
$ mcnp name=inp28 xsdir=testdir.
$ rename ex5a.out inp28o.dat
$ rename ex5a.run inp28r.dat
$ differ inp28m.dat mctl28. /ignore=(trail,blank) /merged=0 /output=difm28
$ differ inp28o.dat outp28. /ignore=(trail,blank) /merged=0 /output=difo28
$ dele inp28r.dat;
$ mcnp name=inp29 rssa=inp07w xsdir=testdir.
$ differ inp29m.dat mctl29. /ignore=(trail,blank) /merged=0 /output=difm29
$ differ inp29o.dat outp29. /ignore=(trail,blank) /merged=0 /output=difo29
$ dele inp29r.dat;

```



## The MCNPC.C file.

```

/*          copyright notice for mcnp version 4b
this program was prepared by the regents of the university of
california at los alamos national laboratory (the university) under
contract number w-7405-eng-36 with the u.s. department of energy
(doe). the university has certain rights in the program pursuant to
the contract and the program should not be copied or distributed
outside your organization. all rights in the program are reserved by
the doe and the university. neither the u.s. government nor the
university makes any warranty, express or implied, or assumes any
liability or responsibility for the use of this software.

-----
*/

#include <stdio.h>
#include <unistd.h>
#include <types.h>
#include <time.h>
/*          */
/* Enable plotting with the XLIB window system.          */
/*          */
/* Get the XLIB include files.          */
/*          */
#include <X11/Xlib.h>
#include <X11/Xutil.h>
#include <X11/Xos.h>
#include <X11/Xatom.h>
#include <X11/cursorfont.h>
/* Define the icon bitmap - created by "bitmap filename 40x40".          */
#define icon_bitmap_width 40
#define icon_bitmap_height 40
static char icon_bitmap_bits[] = {
    0x00, 0x00, 0x00, 0x00, 0x00, 0xfe, 0x07, 0xe0, 0x0f, 0x38, 0x00, 0x00,
    0x1c, 0x70, 0x20, 0xfe, 0x07, 0x43, 0x80, 0x31, 0x00, 0x80, 0x40, 0x00,
    0x22, 0xfe, 0x47, 0x40, 0x00, 0x3c, 0x00, 0x20, 0x40, 0xe0, 0x08, 0xfe,
    0x17, 0x7c, 0x80, 0x10, 0x00, 0x10, 0x83, 0x41, 0x10, 0x00, 0x88, 0x00,
    0x22, 0x20, 0x00, 0x88, 0x00, 0xe2, 0x20, 0x00, 0x48, 0x00, 0x7c, 0x20,
    0x00, 0x44, 0x00, 0x87, 0x41, 0x00, 0x44, 0x80, 0x04, 0x42, 0x00, 0x44,
    0x80, 0x04, 0x42, 0x00, 0x44, 0x40, 0x04, 0x44, 0x00, 0x84, 0x40, 0x02,
    0x44, 0x00, 0x84, 0x40, 0x02, 0x44, 0x00, 0x04, 0xc3, 0x01, 0x44, 0x00,
    0x08, 0x7c, 0x00, 0x24, 0x00, 0x08, 0x80, 0x00, 0x22, 0x00, 0x08, 0x80,
    0x00, 0x22, 0x00, 0x10, 0x00, 0x83, 0x11, 0x00, 0x10, 0x00, 0x7c, 0x10,
    0x00, 0x20, 0x00, 0x00, 0x08, 0x00, 0x40, 0x00, 0x00, 0x04, 0x00, 0x80,
    0x00, 0x00, 0x02, 0x00, 0x00, 0x03, 0x80, 0x01, 0x00, 0x00, 0x1c, 0x70,
    0x00, 0x00, 0x00, 0xe0, 0x0f, 0x00, 0x00, 0x00, 0x00, 0x00, 0x00, 0x00,
    0x00, 0x00, 0x00, 0x00, 0x20, 0xe2, 0x23, 0xc4, 0x07, 0x60, 0x23, 0x60,
    0x44, 0x04, 0xa0, 0x22, 0xa0, 0x44, 0x04, 0x20, 0x22, 0xa0, 0xc4, 0x07,
    0x20, 0x22, 0x20, 0x45, 0x00, 0x20, 0x22, 0x20, 0x46, 0x00, 0x20, 0xe2,
    0x23, 0x44, 0x00, 0x00, 0x00, 0x00, 0x00, 0x00};
/* Define the XLIB variable structures.          */
Colormap      cmap;
Cursor        cursor;
Display       *display;
GC            gc;
Pixmap        icon_pixmap;
Window        win,root,child;
XCharStruct   char_info;
XColor        exact,color_fore,color_back;
XEvent        report;

```

```

XFontStruct      *font_info, *font_scl_info;
XSetWindowAttributes attributes;
XSizeHints      *size_hints;
XTextProperty   windowName, iconName;
XVisualInfo     visual_info;
XWMHints        *wm_hints;
/* Define the global variables. */
char *cname[]={ "purple", "blue", "green", "yellow", "pink",
                "light sky blue", "orange", "grey", "light blue",
                "pale green", "black", "blue", "red", "green", "purple",
                "yellow", "" },
*display_name=NULL,
*font_bas[]={ "-*-courier-bold-*-*--10-100-75-75-*--iso8859-1",
              "-*-courier-*-*--75-75-*--iso8859-1",
              "-*-75-75-*--iso8859-1", "" },
font_scl[]="-itc-courier-bold-*-*--0-75-75-*--iso8859-1",
font_scl_beg[100], font_scl_end[100],
font_std[]="-*-courier-bold-*-*--100-75-75-*--iso8859-1",
font_std_beg[100], font_std_end[100],
*icon_name="plot", *window_name="MCNP PLOT WINDOW";
int border_width=10, ch_flag, ch_old, ch_pixel, color_flag,
cursor_shape[]={XC_cross, XC_top_left_corner,
XC_bottom_right_corner}. depth, display_height,
display_height_mm, display_width, display_width_mm, height,
pnt_x, pnt_y, res_x, res_y, scrnm, width, win_flag, win_shape,
xo=0, yo=0;
long event_mask=ExposureMask|ButtonPressMask|StructureNotifyMask;
float ch_cm, xmax, xmin, ymax, ymin;
/* */
/* Provide routines that follow the gks structure. */
/* */
xgstxfp ()
/* Initialize the scalable, standard, and basic fonts. */
/* This is called by xgacwk() rather than sub. gstxfp in MCNP which */
/* is positioned poorly in sub. gxon. */
{
int i,j,field,end;
/* Setup the scalable font - insert the display resolutions. */
for(i=j=field=end=0; field<=14&&font_scl[i]!='\0'; i++)
{ if(end)font_scl_end[j++]=font_scl[i];
else font_scl_beg[j++]=font_scl[i];
if(font_scl[i]=='-')
{ field++;
switch (field)
{ case 8:
font_scl_beg[j]='\0';
while(font_scl[i+1]!='-')i++;
end=1;
j=0;
break;
case 9:
sprintf(&font_scl_end[j],"%d",res_x);
while(font_scl_end[j]!='\0')j++;
while(font_scl[i+1]!='-')i++;
break;
case 10:
sprintf(&font_scl_end[j],"%d",res_y);
while(font_scl_end[j]!='\0')j++;
while(font_scl[i+1]!='-')i++;
break;
}
}
}
}

```

```

    }
}
font_scl_end[j]='\0';
/* Setup the standard font for scaling. */
for(i=j=field=end=0; field<=14&&font_std[i]!='\0'; i++)
{ if(end)font_std_end[j++]=font_std[i];
  else font_std_beg[j++]=font_std[i];
  if(font_std[i]=='-')
  { field++;
    switch (field)
    { case 8:
      font_std_beg[j]='\0';
      while(font_std[i+1]!='-')i++;
      end=1;
      j=0;
      break;
    }
  }
}
font_std_end[j]='\0';
/* Load the basic font. */
XSetFont(display,gc,font_info->fid);
}
xscfont ()
/* Load a font that matches the character height. */
{
char ch_point[4],font[300];
int i;
ch_old=ch_pixel;
/* First, attempt to load a scalable font. */
font[0]='\0';
sprintf(&ch_point[0],"%d",10*ch_pixel);
strcat(font,font_scl_beg);
strcat(font,ch_point);
strcat(font,font_scl_end);
if((font_scl_info=XLoadQueryFont(display,font))!=NULL)
{ XSetFont(display,gc,font_scl_info->fid);
  return;
}
/* Next, attempt to load a scaled standard font (8,10,12,or 14 point).*/
font[0]='\0';
for(i=8; ch_pixel>=i+2&&i<=14; i=i+2);
sprintf(&ch_point[0],"%d",10*i);
strcat(font,font_std_beg);
strcat(font,ch_point);
strcat(font,font_std_end);
if((font_scl_info=XLoadQueryFont(display,font))!=NULL)
{ XSetFont(display,gc,font_scl_info->fid);
  return;
}
/* Otherwise use the basic font. */
XSetFont(display,gc,font_info->fid);
}
cnint (x)
/* Provide nearest integer function. */
float x;
{
return (int) (x+.5);
}

```

```

xevent (wait)
/* Process the various events - wait specifies an event to wait for. */
int  wait;
{
int  x,y;
unsigned int mask;
switch (wait)
{ case 0:
/* Don't wait for any specific event - process all events.          */
while (1)
{ if(!XCheckWindowEvent(display,win,event_mask,&report))return;
switch (report.type)
{ case ConfigureNotify:
width=report.xconfigure.width;
height=report.xconfigure.height;
break;
case Expose:
case ButtonPress:
break;
}
}
break;
case 1:
/* Wait to process a ButtonPress event and get pointer location.      */
XWindowEvent(display,win,ButtonPressMask,&report);
XQueryPointer(display,win,&root,&child,&x,&y,&pnt_x,&pnt_y,&mask);
break;
case 2:
/* Wait to process a ConfigureNotify event and get the window size.   */
XWindowEvent(display,win,StructureNotifyMask,&report);
width=report.xconfigure.width;
height=report.xconfigure.height;
break;
case 3:
/* Wait to process an Expose event.                                    */
XWindowEvent(display,win,ExposureMask,&report);
break;
}
}
xgopwk (error_flag)
/* Connect to the server display and get its dimensions.              */
/* The display can be set using "setenv DISPLAY host_name:0".        */
int  *error_flag;
{
int  i;
/* Allocate needed memory and connect to the display.                */
if(!(size_hints=XAllocSizeHints()))
{ printf("xlib:  unable to allocate needed memory.\n");
return *error_flag=-1;
}
if(!(wm_hints=XAllocWMHints()))
{ printf("xlib:  unable to allocate needed memory.\n");
return *error_flag=-1;
}
if((display=XOpenDisplay(display_name))==NULL)
{ printf("xlib:  unable to connect to server display.\n");
return *error_flag=-2;
}
/* Store the window and icon names.                                    */
if(XStringListToTextProperty(&window_name,1,&windowName)==0)

```

```

    { XCloseDisplay(display);
      printf("xlib: unable to perform structure allocation.\n");
      return *error_flag=-3;
    }
  if(XStringListToTextProperty(&icon_name,1,&iconName)==0)
    { XCloseDisplay(display);
      printf("xlib: unable to perform structure allocation.\n");
      return *error_flag=-3;
    }
  /* Load the basic font - search several representations for a match. */
  for(i=0; *font_bas[i] != '\0'; i++)
    if((font_info=XLoadQueryFont(display,font_bas[i]))!=NULL) break;
  if(font_info==NULL)
    { XCloseDisplay(display);
      printf("xlib: unable to open a font file.\n");
      return *error_flag=-4;
    }
  /* Get the screen number and display dimensions. */
  scrnrm=DefaultScreen(display);
  display_width=DisplayWidth(display,scrnrm);
  display_width_mm=DisplayWidthMM(display,scrnrm);
  display_height=DisplayHeight(display,scrnrm);
  display_height_mm=DisplayHeightMM(display,scrnrm);
  res_x=25.4*display_width/display_width_mm;
  res_y=25.4*display_height/display_height_mm;
}
xgclwk ()
/* Release font memory and disconnect from display and server. */
{
XUnloadFont(display,font_info->fid);
XCloseDisplay(display);
}
xgacwk ()
/* Initialize all window parameters. */
{
/* Note xo,yo is the window origin relative to upper lefthand corner. */
/* Set window height to min(80% display_height, display_height-yo). */
height=cnint(0.8*display_height);
if(height>display_height-yo)height=display_height-yo;
/* Start with a rectangle viewport (scale factor in sub. tekdrv). */
win_shape=0;
width=cnint(height*4./3.);
if(width>display_width-xo)
  { width=display_width-xo;
    height=cnint(width*3./4.);
  }
/* Create an unmapped subwindow of the root. */
win_flag=0;
win=XCreateSimpleWindow(display,RootWindow(display,scrnrm),xo,yo,width,
                        height,border_width,BlackPixel(display,scrnrm),
                        WhitePixel(display,scrnrm));
/* Create pixel map for icon of plot window. */
icon_pixmap=XCreateBitmapFromData(display,win,icon_bitmap_bits,
                                   icon_bitmap_width,icon_bitmap_height);
/* Initialize various window manager properties. */
size_hints->flags=PPosition|PSize|PMinSize;
size_hints->min_width=cnint(width/2.0);
size_hints->min_height=cnint(height/2.0);
wm_hints->initial_state=NormalState;
wm_hints->input=True;

```

```

wm_hints->icon_pixmap=icon_pixmap;
wm_hints->flags=StateHint|IconPixmapHint|InputHint;
XSetWMProperties(display,win,&windowName,&iconName,NULL,0,size_hints,
                wm_hints,NULL);
/* Select the event types - most are not currently used. */
XSelectInput(display,win,event_mask);
/* Create the graphics context. */
gc=XCreateGC(display,win,0,NULL);
XSetForeground(display,gc,BlackPixel(display,scrnrm));
XSetBackground(display,gc,WhitePixel(display,scrnrm));
if(XDoesBackingStore(DefaultScreenOfDisplay(display)) != NotUseful)
{ attributes.backing_store=Always;
  XChangeWindowAttributes(display,win,CWBackingStore,&attributes);
}
/* Initialize the fonts. */
xgstxfp ();
ch_flag=0;
ch_old=0;
}
xgdawk ()
/* Release window memory and remove plot window. */
{
if(font_scl_info!=NULL)XUnloadFont(display,font_scl_info->fid);
XFreeGC(display,gc);
XDestroyWindow(display,win);
XFlush(display);
}
xgclrw ()
/* Clear the window. */
{
XClearWindow(display,win);
}
xguwk ()
/* Sound the bell and process any queued events. */
{
XBell(display,100);
XFlush(display);
}
xgpl (x1,y1,x2,y2)
/* Draw a line from point x1,y1 to x2,y2. */
float *x1,*y1,*x2,*y2;
{
int xa,ya,xb,yb;
xa=cnint(width*(x1-xmin)/(xmax-xmin));
xb=cnint(width*(x2-xmin)/(xmax-xmin));
ya=cnint(height*(ymax-y1)/(ymax-ymin));
yb=cnint(height*(ymax-y2)/(ymax-ymin));
XDrawLine(display,win,gc,xa,ya,xb,yb);
}
xgtx (string,length,x,y)
/* Draw a character string starting at point x,y. */
char *string;
int *length;
float *x,*y;
{
char *ch_str;
int xa,ya,i;
ch_str=string;
if(ch_pixel!=ch_old)xscfont();
xa=cnint(width*(x-xmin)/(xmax-xmin));

```

```

ya=cnint(height*(ymax-*y)/(ymax-ymin));
if(ch_flag)for(i=*length-1; i>=0; i--)
    { XDrawImageString(display,win,gc,xa,ya,ch_str+i,1);
      ya=ya-font_scl_info->ascent-font_scl_info->descent;
    }
else XDrawImageString(display,win,gc,xa,ya,ch_str,*length);
}
xgschh (ch)
/* Set the character height in pixels. */
float *ch;
{
ch_cm=*ch;
if(ch_flag)ch_pixel=ch_cm*width/(xmax-xmin);
else ch_pixel=ch_cm*height/(ymax-ymin);
}
xgschu (x,y)
/* Set the character up vector - ch_flag=1 for rotated text. */
float *x,*y;
{
float xa,ya;
xa=*x;
ya=*y;
if(xa < 0.)xa=-1.*xa;
if(ya < 0.)ya=-1.*ya;
if(xa > ya)
ch_flag=1;
else
ch_flag=0;
}
xgswn (x1,x2,y1,y2)
/* Save the window size. */
float *x1,*x2,*y1,*y2;
{
xmin=*x1;
xmax=*x2;
ymin=*y1;
ymax=*y2;
}
xgswk (x1,x2,y1,y2)
/* Draw the window on the display. */
float *x1,*x2,*y1,*y2;
{
float scale;
int pre_width;
long int i;
/* Check if the window has been resized. */
xevent(0);
pre_width=width;
/* Scale = 1.25 for a rectangular window and 1.00 for for square. */
scale=(*x2-*x1)/(*y2-*y1);
win_shape=0;
if(scale <= 1.01)win_shape=1;
width=cnint(height*scale);
if(width>display_width-xo)
{ width=display_width-xo;
height=cnint(width/scale);
}
}
if(width != pre_width)
{ XResizeWindow(display,win,width,height);
xevent(2);
}

```

```

}
/* Raise the window on the display. */
XMapRaised(display,win);
/* First time wait for an expose event - process all other events. */
if(!win_flag)xevent(3);
win_flag=1;
xevent(0);
for(i=0; i<1000000; i++)
}
xgrq1c (flag,x,y)
/* Get pointer position. */
int *flag;
float *x,*y;
{
long int i;
int x1,x2,y1,y2;
/* Set cursor, flush previous ButtonPress events, and sound the bell. */
cursor=XCreateFontCursor(display, cursor_shape[*flag-1]);
XDefineCursor(display,win,cursor);
if(color_flag)XRecolorCursor(display,cursor,&color_fore,&color_back);
xevent(0);
XBell(display,100);
/* Wait for user input via any mouse button. */
xevent(1);
/* Place the appropriate cross-hair at the chosen pixel. */
if(*flag==1)
{ x1=pnt_x-height/80;
x2=pnt_x+height/80;
y1=pnt_y-height/80;
y2=pnt_y+height/80;
}
else
{ x1=xo+width*(1-win_shape)/4;
x2=width;
y1=yo;
y2=height;
}
XDrawLine(display,win,gc,pnt_x,y1,pnt_x,y2);
XDrawLine(display,win,gc,x1,pnt_y,x2,pnt_y);
XFlush(display);
for(i=0; i<1000000; i++)
/* Return the pixel location. */
*x=xmin+pnt_x*(xmax-xmin)/width;
*y=ymin+pnt_y*(ymax-ymin)/height;
if(*flag!=2)XUndefineCursor(display,win);
}
xgfa (x1,y1,x2,y2)
/* Fill the rectangular area with the initialized color. */
float *x1,*y1,*x2,*y2;
{
int xa,ya,xb,yb;
xa=cnint(width*( *x1-xmin)/(xmax-xmin));
xb=cnint(width*( *x2-xmin)/(xmax-xmin));
ya=cnint(height*(ymax-*y1)/(ymax-ymin));
yb=cnint(height*(ymax-*y2)/(ymax-ymin));
XFillRectangle(display,win,gc,xa,ya,xb-xa,yb-ya);
}
xgsplc (ic)
/* Set the line color. */
int *ic;

```



```

{
if(XAllocNamedColor(display,cmap,cname[*ic-1],&color_fore,&exact))
    XSetForeground(display,gc,color_fore.pixel);
}
xgqcf (type,nc)
/* Set the color flag if a color display is used. */
int *type,*nc;
{
int i,j;
color_flag=0;
if((depth=DefaultDepth(display,scrnrm)) == 1)return;
cmap=DefaultColormap(display,scrnrm);
for(i=5; i>=StaticColor; i--)
    if(XMatchVisualInfo(display,scrnrm,depth,i,&visual_info))
        { color_flag=1;
          XAllocNamedColor(display,cmap,"white",&color_back,&exact);
          for(j=0; *cname[j] != '\0'; j++);
          return *type=1, *nc=j;
        }
}
/* */
/* Provide auxiliary c routines. */
/* */
xlnwid (scale)
/* Set the line attributes, scale the line width. */
float *scale;
{
int np;
np=cnint(*scale);
XSetLineAttributes(display,gc,np,LineSolid,CapRound,JoinRound);
}

```

**S  
E  
C  
T  
I  
O  
N  
  
7**

**Los Alamos**  
NATIONAL LABORATORY  
**research note**

*The Applied Theoretical Physics Division  
Transport Methods Group*

To/MS: Distribution

From/MS: Tim Goorley *TG*

Phone/FAX: 665-3682

Symbol: XTM-RN (U) 97-028

Date: July 22, 1997

**MCNP4B™ in Parallel on PC's Running Linux**

**Table of Contents**

1.0 Introduction.....	2
2.0 Installation of Linux.....	2
A. Red Hat vs. Slackware	
B. GNU Compilers	
3.0 Installation of PVM.....	4
4.0 Installation of MCNP4B.....	5
A. Install.fix	
B. MCSETUP	
C. PRPR	
5.0 Conversion of Cross Sections.....	7
6.0 Verification of MCNP.....	8
Appendix A - Linux PVM Install.fix.....	11

## 1.0 Introduction

The new release of MCNP<sup>1</sup>, MCNP4B, has the capability of running in parallel on a heterogeneous network of computers running Linux, SUN OS, SUN Solaris and others. Linux is an attractive option since it is free and can be installed on personal computers using Pentium and Pentium Pro chips. When used in parallel, a group of these machines offers a cost effective alternative with much computing power.

Linux offers users much flexibility. It can be obtained free of charge from a variety of distributors, notably Slackware and Red Hat. Linux will run on a variety of hardware: 386, 486, Pentium, Pentium Pro and more. It can be installed on systems already running popular operating systems, such as Windows NT, Windows 95, DOS and others. In this particular demonstration, Slackware Linux 3.2 was installed on a 200 MHz Pentium Pro Micron tower and a 166 MHz Pentium Sager laptop. Red Hat Linux 4.2 was installed on another 200 MHz Pentium Pro Micron tower. Both Microns were running Windows NT, while the laptop was running Windows 95.

## 2.0 Installation of Linux

Linux installation is reasonably straightforward. First the Linux installation files are obtained from the distributor, commonly Red Hat or Slackware. Included are two files necessary to boot Linux from a pair of floppies. Using the computer's native operating system, the hard drive's partitions are resized, creating free space. The computer is then restarted and Linux is booted from the two floppies. The Linux operating system on these disks is used to create Linux partitions on the hard drive, install the Linux information from CD-ROM or other hard drive partitions, and then reconfigure the operating system to reflect the current hardware. A more complete review of the installation process than what follows can be found in The Linux Installation HOWTO.

Although the Linux operating system contained in the installation files is the same, the different distributions vary drastically in organization. Slackware is organized in installation disk sets, which contain all appropriate files for a full or partial Linux installation. Even though these disk sets represent Linux installation from floppy disks, if the file structure is preserved, the files can be placed on hard drives, CD-ROM or jaz drives. The following disk sets are strongly recommended for Linux, PVM and MCNP installation:

Set A:	General	9 disks
Set AP:	Applications	5 disks
Set D:	Program Development	13 disks
Set E:	Emacs 19.25	8 disks
Set F:	FAQ	3 disks
Set K:	Kernel Source Code	6 disks
Set N:	Networking	6 disks
Set X:	X-Windows	23 disks
Set XA:	X-Windows Applications	4 disks

<sup>1</sup> MCNP is a trademark of the Regents of the University of California, Los Alamos National Laboratory.

These disk sets are located on the Slackware CD-ROM, or they can be binary FTP'ed free of charge from <ftp.cdrom.com:/pub/Linux/Slackware>. If FTP is used, each floppy disk of information must be transferred into its own appropriate subdirectory. The entire process of downloading the above disk sets using the computer's native operating system onto a FAT partition took three to four hours. The download was performed using Windows NT. Had the partition been formatted NTFS, which Linux has difficulty recognizing, the disk sets would need to be copied to a FAT jaz drive or the CD-ROM should be ordered. Red Hat does not use this organization scheme.

The Linux operating system essential files are small enough to fit onto two floppy disks, called the boot and root disks. A boot disk is created from a boot disk image which is specific to categories of computers: those with IDE or SCSI hard drives, those with certain kinds of CDROM drives, etc. The Flashpoint SCSI card installed on two Micron machines required a special boot image, `buslogic.bin`, found at <http://www.dandelion.com/Linux/>. After downloading, `buslogic.bin` was then be copied onto a floppy disk from a DOS system with the command "rawrite". In UNIX, the command "dd" is used: "dd if=`buslogic.bin` of=`/dev/fd0` obs=18k". To create a boot disk for the Windows 95 laptop, a boot disk that can recognize the FAT32 IDE hard disk, `FAT32.i`, was copied. Two generic boot disks are `scsi.s` and `bare.i`. In a similar fashion, `color144.gz` and `Pcmcia.gz` were also copied onto floppies for the Microns and laptop root disks respectively. Many other boot disk and root disk images can be found at the Linux installation FTP site, <ftp.cdrom.com:/pub/linux>, as well as the files that describe which images are appropriate for specific hardware. These boot and root floppies also serve as emergency repair disks.

Before a full installation can proceed, the hard drive should be properly prepared. There should be at least one gigabyte of free space on the computer's hard drive to install Linux, PVM and MCNP. Using a program called Partition Magic, it is possible to resize the existing FAT, FAT32 or NTFS hard drive partitions. Unfortunately, Linux can only have read-write capability with FAT and FAT32 formats, and the hard drive format cannot be changed without loosing the data. After this free space is created, the computer is booted using the Slackware or Red Hat installation disks. After logging in as root, `fdisk` is started either manually or automatically, depending on the Linux distribution. `Fdisk` can create, destroy and modify the hard drive's partitions. By typing "n" at the prompt, a new partition is created from the free space. This partition should start in the next consecutive sector from the previous partition, but should not take up the remaining space. In the last 100 megabytes, a second new partition should be created for the Linux swap space. The file systems should be specified as Linux native and Linux swap, 83 and 82, by typing "t". Finally, "w" should be specified to write the changes to the disk and exit.

Linux installation follows automatically for Red Hat users, while Slackware installers must type "setup". Both guide the user. After Linux is installed, the kernel can be remade for its specific machine configuration by typing "`/usr/src/linux make config`". After answering many questions concerning hardware and other options, the kernel will be rebuilt. New boot disks can be created by typing "make zDisk" in the `/usr/src/linux` directory. If LILO is installed on the hard drive, "make zlilo" will update the boot program so that the new kernel will load on the next reboot.

## REDHAT vs. SLACKWARE

Linux comes from a variety of distributors, notably Red Hat and Slackware. Although the two companies distribute a Linux operating system very similar, the user installation procedures are completely different. Red Hat is known for its easier graphical interface, but Red Hat Linux 4.2 was more difficult to install than Slackware Linux 3.2. Red Hat had a bug in the password writing routine, preventing normal login after completing the setup. Although the solution was to type "Linux single" from the LILO boot prompt and erase the second field of the root user in /etc/passwd, this is certainly not intuitive. Another drawback is that the Red Hat network configuration program runs in X Windows. On several laptop computers, where the display hardware does not support X windows, it would have been much more difficult to configure the network. Although Slackware does require a more adept installer, it offers more flexibility in what applications are installed and in what way.

## GNU COMPILERS

Although both distributions of Linux came with a C compiler, the newest versions of GNU C and GNU F77 were installed. They can be obtained via anonymous FTP to prep.ai.mit.edu in the /pub/gnu directory. GCC 2.7.2.2 and G77 0.5.20 were installed in the /usr/local/src directory. The following is the installation process:

1. mv g77-0.5.20.tar.gz /usr/local/src; mv gcc-2.7.2.2.tar.gz /usr/local/src
2. cd /usr/local/src
3. gunzip g77-0.5.20.tar.gz ; gunzip gcc-2.7.2.2.tar.gz
4. tar -xf g77-0.5.20.tar.gz ; tar -xf gcc-2.7.2.2.tar.gz
5. ln -s gcc-2.7.2.2 gcc ; ln -s g77-0.5.20 g77
6. mv -i g77/\* gcc
7. patch -p1 -d gcc-2.7.2.2 < gcc-2.7.2.2./f/gbe/2.7.2.2.diff
8. cd gcc
9. touch f77-install-ok ; touch f2c-install-ok
10. ./configure -- prefix=/usr --host=i585-\*-linuxlibc1
11. make bootstrap
12. rm -fr stage1
13. make -k install
14. g77 -v ; gcc --version

After the compilers are created, the Linux X Windows server, X11R6 can be configured. This process is dramatically different for the different Linux distributions. Although not necessary, X11R6 allows the user to run many graphical programs, including the plotting capabilities of MCNP. After installation, the server can be started by typing "startx".

## 3.0 Installation of PVM

Parallel Virtual Machine installation is comprised of three simple steps. After obtaining the most recent version of PVM, 3.3.11, available by anonymous FTP to netlib2.cs.utk.edu, it should be unzipped and untarred in the /usr/local/src directory. The PVM environmental variables then need to be set by typing "export variable=value" or "setenv variable value", depending on whether the command shell is bash or csh. PVM\_ROOT should be set to

“/usr/local/src” and PVM\_ARCH should equal “LINUX”. In the pvm3 directory created by untarring the file, make is typed to create the libraries and executables. Several PVM programs provided in the distribution can be compiled and used to test the virtual machine. For example, hello is created by typing “aimk hello” in the examples directory.

Once a working PVM executable is created, proper network connectivity should be ensured. The /etc/hosts.allow needs to allow rsh connections from other computers. Remote hosts also need to be added by name to the .rhosts file. Two programs, rsh and rlogin need to be working properly before PVM can add remote hosts to the virtual machine. The permissions of these programs should be set to -rwsr-xr-x and should be owned by root. The root user, however, will be unable to use them. Other users may need to add the full name, ip address, local name and aliases of all remote hosts and the local host to the .rhosts file located in their home directory. If the local host still cannot add remote machines, it may be useful to check if environmental variables are being passed correctly. Type:

```
rsh remote_host '$PVM_ROOT'/lib/pvmd -s
```

The response should be:

```
[pvmd pid6918] slave_config: bad args
[pvmd pid6918] pvmbailout(0)
```

Another environmental variable, PVM\_DPATH may need to be set to pvm3/lib/pvmd on the local Linux machine to add SUN or Solaris machines, provided the files are in \$HOME/pvm3 on the remote system. Even if hosts cannot be added from the PVM console, it is possible to manually startup and connect the PVM deamons. The PVM manual is a useful reference for trouble shooting.

For MCNP to run in parallel, several criteria must be satisfied. Besides the requirements for PVM to run, MCNP must be built with the PVM option and linked with the PVM libraries. A soft link to the MCNP executable, called mcnp.pvm, must exist in the \$HOME/pvm3/bin/PVM\_ARCH directory on every remote machine.

#### 4.0 Installation of MCNP4B

MCNP4B can be installed on Linux systems in a similar manner to other systems, as described in appendix C of the MCNP manual. The install.fix file that contains both Linux and PVM patches is needed for the PVM enabled version of MCNP, as well as a new version of prpr.id.

The Linux install.fix file contains the Linux compile options under the sixth operating system, DEC UNIX. Below is the relevant portion of the file.

```
***** FIXES FOR SYSTEM 6 (DEC UNIX and PC Linux) *****
```

c

c The following 7 lines enable GNU F77 compilation on Linux.

```

6 1 2 1 1
*define linux
6 2 27 3 1
-O0
6 2 28 4 28
6 3 2 1 1
*define linux

```

The first and last line add the Linux option to take advantage of a Linux patch at the end of the install.fix file. The second line adds some compiler options to f77 -c \*.f, while the third deletes the line f77 -O1 -fpe1 -c itally.f getxs.f gmgww.f. The Linux patch at the bottom of the install.fix file is:

```

*/ ----- getidt
*/ Provide cleaner separation of Linux and DEC. 06/04/97 (GWM/GWM)
*d,gi4b.1 <42208>
*if def,linux,3
*d,gi4b.5 <42212>
*i,gi4a.1 <42213>
*if -def,linux,3

```

The install.fix files are available by FTP to CFS.

#### MCSETUP

The installation process compiles and runs MCSETUP, which creates a batch file that will compile PRPR, MAKXSF and MCNP. Several options in MCSETUP must be changed to create the appropriate MCNP executable. The computer system description, option 1.1, must be changed from Cray Unicos to dec. The dynamic memory option, since pointer creates many compile errors in Linux, must be avoided by setting the mdas value under option 2.3. If mcplot and plot are used, the X Windows Library, option 3.3, must be changed to find the corresponding Linux X11R6 files. The user is directed to enter the library directory, /usr/X11R6/lib, the library, libX11.so, and the include directory, /usr/X11R6/include. The cross section data was installed in /usr/mcnp4b/xs, which can be entered in MCSETUP as option 4.1. The PVM libraries necessary to run the distributed memory version of MCNP, option 5.1, are located in /usr/local/src/pvm3/lib/LINUX. The default names, libfpvm3.a and libpvm3.a are correct.

#### PRPR

MCSETUP will create a batch program called makemcnp, which compiles PRPR. PRPR is the preprocessor used to combine patch files and the MCNP4b source code, mcnp4b.id. While trying to compile prpr.id, f77 gave the following memory warning: "Initialization of large (216000-unit) aggregate area 'hc' at (^) currently very slow and takes lots of memory during g77 compile - to be improved in 0.6". While PRPR was compiled and linked after several minutes, a simple change allows compilation in two or three seconds.

```

***** prpr.orig
3 hj/define',comdeck',deck',call',if',endif/
data hc/lc*' ',hi' ',hl' ',hn/kc*' ',hq/2*' ',

```



```

1 hs/40* ' ,ht' ',hz' ' /
***** prpr.new
3 hj/define',comdeck','deck','call','if','endif'/
data = hi' ',hl' ',hn/kc*' ',hq/2*' ',
1 hs/40* ' ,ht' ',hz' ' /
*****

***** prpr.orig
data i4,i5,ic,il,ik,ja,jd,kd,lq,ns/0,1,9*0/
nc(1)=1
***** prpr.new
data i4,i5,ic,il,ik,ja,jd,kd,lq,ns/0,1,9*0/
do 5 i=1,lc
5 hc(i)= '
nc(1)=1
*****

```

### 5.0 Conversion of Cross Sections

Many users will want to convert their type one ASCII cross sections to type two binary files, due to the considerable disk space reduction. The MAKXSF program, which does this conversion, is compiled in the makemcnp script. This program is described in appendix C of the MCNP manual. A file called specs needs to be changed before the cross sections can be converted. The numbers 2048 and 512, representing the record length and entries per record respectively, need to be added to every line except the last, which uses a recl number of 4096. A Linux specs file would look like:

```

xmdir1 xmdir2
endf601 endf602 2 2048 512

newxs1 newxs2 2 2048 512
.....
mcplib02 mcplib022 2 2048 512

mcplib1 mcplib2 2 2048 512

el1 el2 2 4096 512

```

Using the jaz drive is a convenient way of converting the cross sections, since more than enough space is available. If the jaz drive is MSDOS formatted, the MSDOS naming rules apply. It is necessary to change mcplib02 to mcplib022, not mcplib022. Had the conversion been carried out under the Linux file system, ex2fs, this change should not be necessary. MAKXSF was able to convert the 569 megabytes of ASCII library files to 94 megabytes of binary files.

### 6.0 Verification of MCNP4B

The test suite of twenty-nine test problems is used for MCNP verification. The scripts runprob and runprobmt verify the standard and PVM versions. Both of these scripts should reference the DOS MCTL files, which need to be uncompressed on a DOS machine and FTP'ed to the Linux system. These scripts will compare the tally output of the test problems to the reference tally output, the MCTL files, using the command "diff". When MCNP4b is run sequentially, only one non-zero difference file, difm12, is created. It indicates that a different number of random numbers was used during this execution than was used in the reference execution. This inconsistency is attributed to differences in the Layhey F77 and GNU F77 compilers. When run using PVM, four difm files will be created. Two of them, inp12m and inp08am, do not track. The other two, inp21am and inp28m, are output differences caused by PVM's rendezvous procedure, which is acceptable. Below is a table summarizing the difference files, difm12, difm21a, and difm28, and the files themselves. Difm08a, beyond the header, is too extensive to include here.

Table 1: Non-Zero Difm Files from MCNP4B on Linux

-O0 Optimization	w/o PVM (runprob)	w/ PVM (runprobmt)
File	Size (bytes) Error	Size (bytes) Error
difm08a	N/A N/A	2669 tracking
difm12	128 tracking	3508 tracking
difm21a	N/A N/A	1276 rendezvous
difm28	0 none	698 rendezvous

The above files were created when MCNP was compiled with -O0 optimization.

Difm08a header - 2669 bytes

```
lcl
<          2  1579  21050
---
>          2  1570  19337
```

Difm12 - 146 bytes

```
lcl
<          2  3000  4774870
---
>          2  3000  4774894
```

Difm21a - 1276 bytes

```
273c273,274
< tfc 10  1  1  22  1  1  1  23  1
---
> tfc 20  1  1  22  1  1  1  23  1
> 1000 4.09176E-05 3.71303E-01
274a276
> 3000 4.08754E-05 1.78175E-01
275a278
> 5000 4.55530E-05 1.68729E-01
276a280
> 7000 4.26109E-05 1.35474E-01
277a282
```

```

> 9000 4.09342E-05 1.15212E-01
278a284
> 11000 4.71283E-05 1.23183E-01
279a286
> 13000 4.66970E-05 1.11987E-01
280a288
> 15000 4.50165E-05 1.04542E-01
281a290
> 17000 5.70298E-05 2.23201E-01
282a292
> 19000 5.48663E-05 2.07877E-01
298c308,309
< tfc 10 1 1 1 1 1 1 4 1
---
> tfc 20 1 1 1 1 1 1 4 1
> 1000 4.09176E-05 3.71303E-01
299a311
> 3000 4.08754E-05 1.78175E-01
300a313
> 5000 4.55530E-05 1.68729E-01
301a315
> 7000 4.26109E-05 1.35474E-01
302a317
> 9000 4.09342E-05 1.15212E-01
303a319
> 11000 4.71283E-05 1.23183E-01
304a321
> 13000 4.66970E-05 1.11987E-01
305a323
> 15000 4.50165E-05 1.04542E-01
306a325
> 17000 5.70298E-05 2.23201E-01
307a327
> 19000 5.48663E-05 2.07877E-01

```

## Difm28 - 689 bytes

```

475,476c475,477
< tfc 9 1 1 42 1 1 1 43 1
< 3000 4.92945E-05 6.68206E-01
---
> tfc 13 1 1 42 1 1 1 43 1
> 2000 6.53503E-05 7.50077E-01
> 4000 5.91882E-05 4.71549E-01
478c479,480
< 9000 6.80561E-05 3.98976E-01
---
> 8000 7.29853E-05 4.17453E-01
> 10000 6.23468E-05 3.92323E-01
480c482,483
< 15000 5.00067E-05 3.34972E-01
---
> 14000 5.30353E-05 3.38257E-01
> 16000 6.61325E-05 3.71568E-01
482c485,486
< 21000 6.19494E-05 3.09465E-01
---
```

```
> 20000 5.87871E-05 3.36357E-01
> 22000 5.99188E-05 3.05517E-01
```

The above differences were created with a compilation of MCNP with out optimization. Although zero optimization produces the fewest number of difm files, runtimes can be considerably reduced at higher optimizations. When the -O2 optimization is enabled, the following difm files are created when runprob and runprobmt are run:

Table 2: Non-Zero Difm Files from MCNP4B on Linux

-O2 Optimization	w/o PVM (runprob)		w/ PVM (runprobmt)	
File	Size (bytes)	Error	Size (bytes)	Error
difm08a	N/A	N/A	2669	tracking
difm12	3508	tracking	3508	tracking
difm21a	N/A	N/A	1276	rendezvous
difm28	0	none	698	rendezvous
difm29	1686	tracking	1686	tracking
difm29a	N/A	N/A	1686	tracking

The above files were created when MCNP was compiled with -O2 optimization.

There are also CPU specific optimizations. The -m486 option is optimization for the 486. The optimization for the Pentium is: -O2 -m486 -malign-loops=2 -malign-jumps=2 -malign-functions=2. There currently is no specific optimization for the Pentium Pro. The difference between the 486 options and the Pentium options on a Pentium Pro machine are negligible. Since optimizations above -O0 cause more problems not to track, they clearly change answers and thus are officially unacceptable.

Linux is a powerful operating system that can be installed on a variety of personal computers. MCNP4B can be installed on Linux machines and run in parallel over a heterogeneous network of computers. Installation is straight forward and can be completed by running "/install dec" with Linux install.fix and prpr.id files, along with the other required files. The quality of the program can be verified by running the test suite, which produces two tracking errors, potentially attributed to compiler differences. The result is an officially acceptable version of MCNP4B.

#### Acknowledgment

I would like to thank Dr. Gregg McKinney for his time, effort and extensive knowledge. Without his help and a previous memo by Cameron Kellough, this project would have been much more difficult.

#### REFERENCES

1. J.F. Briesmeister, Ed., "MCNP - A General Monte Carlo N-Particle Transport Code," v. 4B, Los Alamos National Laboratory report LA-12625-M Version 4B (March 1997).
2. Al Geist, et. all. "PVM: Parallel Virtual Machine - A User's Guide and Tutorial for Networked Parallel Computing" Cambridge, MA. The MIT Press. 1994

**Appendix A - Linux PVM Install.fix**

```

c <<<<< makemcnp changes for MCNP4B >>>>>   loddatt 07/07/97
c
c For each fix, enter five integer parameters on one line in free
c format, ip(1)-ip(5) described below, followed by the appropriate
c number of new lines.
c
c ip(1) = The applicable computer system number or 0 for all systems.
c ip(2) = The file number:
c   1 = patchf
c   2 = makemcnp
c   3 = patchc
c ip(3) = The applicable line number to edit-see the MCSETUP source.
c ip(4) = The alter code:
c   1 = insert the following ip(5) line(s) before line ip(3)
c   2 = replace line ip(3) with the following ip(5) line(s)
c   3 = insert the following line after entry ip(5) of line ip(3)
c   4 = delete lines ip(3) through ip(5)
c ip(5) = The number of new line(s) if ip(4)=1,2
c         The entry number if ip(4)=3
c         The last line number to delete if ip(4)=4
c
c The number of new lines that follow ip(1)-ip(5) is given by:
c   = ip(5) if ip(4)=1,2
c   = 1 if ip(4)=3
c   = 0 if ip(4)=4
c
c***** FIXES FOR SYSTEM 1 (Cray UNICOS) *****
c
c Add the *define t3d for the Cray T3D.
c 1 1 2 1 1
c *define t3d
c
c Provide links to the T3D compilers and linker. XTM:GWM-95-128
c Change the CFT77 compile line.
c 1 2 18 1 4
c export TARGET; TARGET=CRAY-T3D
c ln -s /mpp/bin/cc cc
c ln -s /mpp/bin/cft77 cft77
c ln -s /mpp/bin/mppldr segldr
c Provide links to the T3D compilers and linker. XTM:GWM-95-128
c 1 2 26 2 1
c cft77 compile
c
c Add CFTLIB library on UNICOS for profile timing. 06/30/95 (GWM)
c 1 2 28 3 10

```

```

c -L/usr/local/lib -lprof

c***** FIXES FOR SYSTEM 2 (Sun SunOS ) *****
c Add a second X-window include path for some SunOS systems.
c 2 2 18 3 4
c -I/usr/openwin/include/X11

c Add a link to the ANSI C library (libansi.a) on some SunOS systems.
c 2 2 29 3 10
c -L/home -lansi

c***** FIXES FOR SYSTEM 3 (IBM AIX ) *****
c
c PVM libraries must go first for pvm version at some installations.
c 3 2 30 2 1
c xlf -o mcnp *.o -L/usr/lanl/pvm3.3/lib -lpvm3 -lpvm3 -L/usr/lib -lX11

c***** FIXES FOR SYSTEM 4 (HP HPUX ) *****
c
c Add a link to the C math library (libM.a) on some HP systems.
c 4 2 29 3 6
c -lM

c***** FIXES FOR SYSTEM 5 (VAX VMS ) *****
c
c Add an additional *define keyword for PRPR on a VAX VMS system.
c 5 1 2 1 1
c *define disscgs

c***** FIXES FOR SYSTEM 6 (DEC UNIX and PC LINUX)
*****
c
c The following 7 lines enable GNU F77 compilation on LINUX.
c Tim Goorley, jgoorley@mit.edu XTM-RN(U97-028) 7/21/97
c 6 1 2 1 1
c *define linux
c 6 2 27 3 1
c -O0
c 6 2 28 4 28
c 6 3 2 1 1
c *define linux

c***** FIXES FOR SYSTEM 7 (PC DOS ) *****
c
c The following 9 lines enable LAHEY F90 compilation on DOS/WINDOWS.

```

```

c Also uncomment the 2 lines in TTYINT below [call break()].
c 7 2 8 2 1
c lf90 prpr.for
c 7 2 9 4 9
c 7 2 17 2 1
c lf90 makxsf.for
c 7 2 18 4 18
c 7 2 43 2 1
c lf90 mcnp.for
c 7 2 50 4 50

```

```

c***** FIXES FOR SYSTEM 8 (Sun Sol. )*****

```

```

c***** FIXES FOR SYSTEM 9 (SGI IRIX )*****

```

```

c***** FIXES FOR THE MCNP FORTRAN SOURCE (PATCHF FILE)
*****

```

```

0 1 11 2

```

```

*/ Integrate your patch with the following. If your patch makes changes
*/ to the ZC, VV, CM, GS, MB, or BD decks, contact MCNP@LANL.GOV for
*/ details on including your patch via the INSTALL.FIX file. When
*/ integrating your patch, be sure the order of the changes (increasing
*/ in line number) is preserved to avoid a PRPR error. See Appendix
*/ C, page C-8 in the MCNP manual for more details.
*/
*/ ----- ttyint
*/ Uncomment (delete 1st 3 columns) of next 2 lines to enable LAHEY F90
*/ compilation on DOS/WINDOWS. 07/07/97 (GWM/GWM)
*/ *d,tt4a.28 <1014>
*/ call break(lockl)
*/
*/ ----- msgcon
*/ Fix a print bug. Wrong number of arguments. 07/07/97 (GWM/GWM)
*/ *d,me4b.195 <20311>
*/ call errprn(0,j,1,one*max(1,ntasks),zero,'ntk','')
*/ Force PVM to free some buffers. 07/07/97 (GWM/GWM)
*/ $20 awarded to Dudley A. Raine, III, ORNL (XTM:JSH-97-176) (GWM/GWM)
*/ *i,me4b.311 <20498>
c
c free the receive buffers.
c do 582 nt=1,ntasks
c 582 call mfbuf(ib(nt),i)
*/
*/ ----- startp

```

```

*/ Wrong index. Affects var. reduction and tracking. 07/07/97 (GWM/GWM)
*d,sp4b.8,sp4b.10 <21159-21161>
  if(wc1(i).ge.0.)go to 85
  wcs1tc(i)=-wc1(i)*wgt
  wcs2tc(i)=-wc2(i)*wgt
*/
*/ ----- ypbssp
*/ Wrong index. Affects var. reduction and tracking. 07/07/97 (GWM/GWM)
*d,yp4b.2,yp4b.4 <22590-22592>
  if(wc1(i).ge.0.)go to 45
  wcs1tc(i)=-wc1(i)*wgt
  wcs2tc(i)=-wc2(i)*wgt
*/
*/ ----- mdbuf
*/ Force PVM to free some buffers. 07/07/97 (GWM/GWM)
*/ $20 awarded to Dudley A. Raine, III, ORNL (XTM:JSH-97-176) (GWM/GWM)
*i,mf4b.83 <41720>
  subroutine mdbuf(ib,in)
c   perform function 'free message buffer'.
*call mb
*if def,pvm,1
  call pvmffreebuf(ib,in)
  return
  end
*/
*/ ----- getidt
*/ Provide cleaner separation of LINUX and DEC. 06/04/97 (GWM/GWM)
*d,gi4b.1 <42208>
*if def,linux,3
*d,gi4b.5 <42212>
*i,gi4a.1 <42213>
*if -def,linux,3

```